

SPECIFICATIONS OF

Model **DRS4D-NXT**

ANTENNA

- Type** ø610 mm Radome (24")
- Beam Width**
- Horizontal 3.9° typical (-3dB)
Adjustable between 2° and 3.9°
(effective with RezBoost control)
 - Vertical 25°
- Antenna Rotation Speed** 24*/36/48 rpm
* In dual range mode, speed is limited to 24 rpm

RF TRANSCIVER

Frequency

Ch #	P0N (MHz)	Q0N (MHz)
1	9380	9400
2	9400	9420
3	9420	9440

- Pulselength & PRR** P0N: 0.08 µs to 1.2 µs / 1100 Hz
Q0N: 5 µs to 18 µs / 1100 Hz
- Peak Output Power** Solid-state, 25 W
- Range Scales** 0.0625 to 36* nm
* In dual range mode, range is limited to 12 nm

ARPA TARGET TRACKING Up to 100 targets

POWER SUPPLY 12-24 VDC: 2.5-1.3 A

ENVIRONMENT Temperature: -25°C to +55°C
Humidity: 93% or less at +40°C
Waterproofing: IP26

- EQUIPMENT LIST**
- Standard
1. Antenna Unit RSB-135-115
 2. Cable Assembly 10/15/20/30m
 3. Spare Parts
- Option
1. Radome Mount OP03-208
 2. Retrofit Kit OP03-239
 3. LAN Cable 2/5/10 m
 4. Joint Box TL-CAT-012

24" Radome Solid State Doppler Radar DRS4D-NXT
7.3 kg 16.1 lb

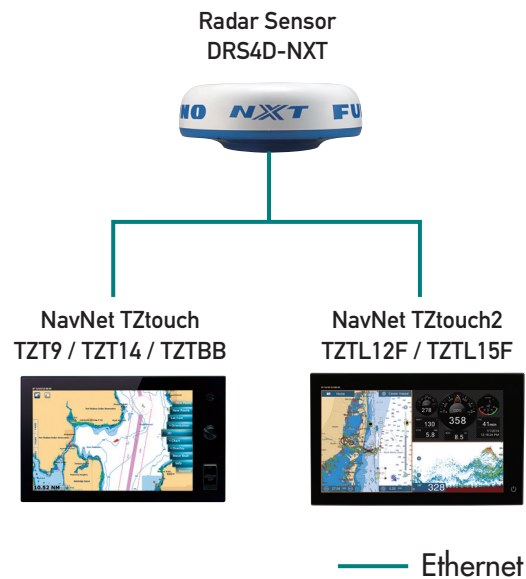
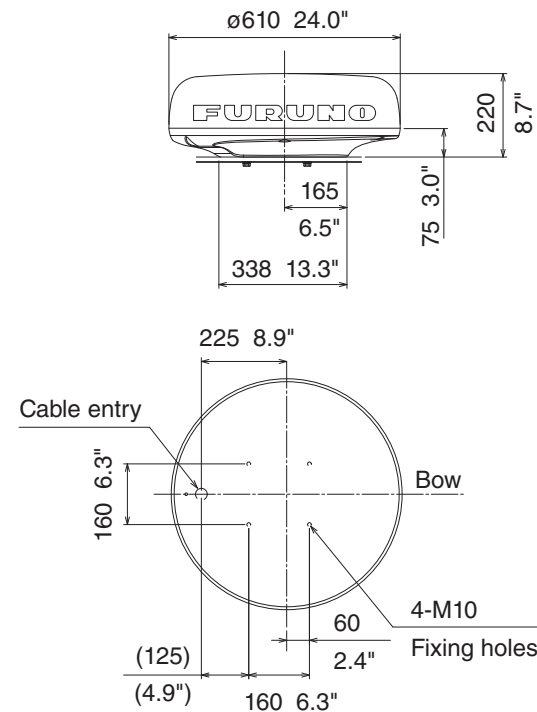

SOLID STATE DOPPLER RADAR
Model **DRS4D-NXT**



Beware of similar products

All brand and product names are registered trademarks, trademarks or service marks of their respective holders.

SPECIFICATIONS SUBJECT TO CHANGE WITHOUT NOTICE

FURUNO ELECTRIC CO., LTD.
Nishinomiya, Hyogo, Japan
www.furuno.com

FURUNO U.S.A., INC.
Camas, Washington, U.S.A.
www.furunousa.com

FURUNO (UK) LIMITED
Havant, Hampshire, U.K.
www.furuno.co.uk

FURUNO FRANCE S.A.S.
Bordeaux-Mérignac, France
www.furuno.fr

FURUNO ITALIA S.R.L.
Gatteo Mare, Italy
www.furuno.it

FURUNO ESPAÑA S.A.
Madrid, Spain
www.furuno.es

FURUNO DANMARK A/S
Hvidovre, Denmark
www.furuno.dk

FURUNO NORGE A/S
Ålesund, Norway
www.furuno.no

FURUNO SVERIGE AB
Västra Frölunda, Sweden
www.furuno.se

FURUNO FINLAND OY
Espoo, Finland
www.furuno.fi

FURUNO POLSKA Sp. z o.o.
Gdynia, Poland
www.furuno.pl

FURUNO EURUS LLC
St. Petersburg, Russian Federation
www.furuno.com.ru

FURUNO SINGAPORE
Singapore
www.rico.com.sg

FURUNO DEUTSCHLAND GmbH
Rellingen, Germany
www.furuno.de

FURUNO HELLAS S.A.
Piraeus, Greece
www.furuno.gr

FURUNO (CYPRUS) LTD
Limassol, Cyprus
www.furuno.com.cy

FURUNO CHINA CO., LTD.
Hong Kong

FURUNO SHANGHAI CO., LTD.
Shanghai, China
www.furuno.com/cn

16025SK Printed in Japan
Catalogue No. R-210



DRS4D-NXT, the NXT leap in Radar technology

A Solid-State Radar with pulse compression, Target Analyzer™ and Fast Target Tracking™ utilizing Doppler technology. Combined with FURUNO's exclusive RezBoost™ technology, the DRS4D-NXT packs the performance of an open array radar, in a compact 24" radome.



NEW Target Analyzer™ function utilizing Doppler technology spots hazardous targets instantly!

The DRS4D-NXT is the first radar in the world to use the new FURUNO exclusive Target Analyzer™ function. Targets that are approaching your vessel automatically change color to help you identify when they are hazardous. Green echoes are targets that stay stationary, or are moving away from you, while red echoes are hazardous targets that are moving towards your vessel. Echoes dynamically change colors as targets approach, or get farther away from your vessel. Target Analyzer™ improves situational awareness and can increase safety by showing you which targets to look out for.

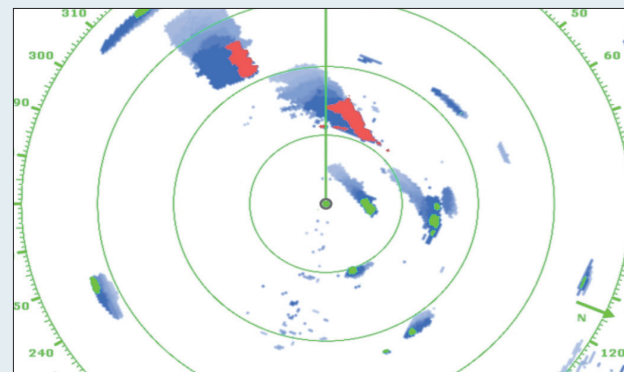

Hazardous targets are displayed in bright red



See moving targets close to structures clearly with Target Analyzer™

- ▶ NXT, Solid-State pulse compression Doppler Radar
- ▶ Revolutionary Target Analyzer™ function instantly identifies hazardous targets
- ▶ Fast Target Tracking™, up to 100 targets
- ▶ RezBoost™ beam sharpening, equivalent to 2 degree beam width open array
- ▶ Compact 24" radome with 25 W output power
- ▶ Bird Mode, track birds to find the best fishing grounds
- ▶ Simple installation, no need to open the radome, external PSU is not required
- ▶ New smart-connector cable for retro fitting existing DRS cable installations
- ▶ No warm-up time

NEW RezBoost™ beam sharpening



RezBoost

For the first time, FURUNO's exclusive RezBoost™ technology has been incorporated into one of our Radar units, with impressive performance. With RezBoost™ set to MAX, the sharpness equivalent of a 2 degree beam width can be achieved. With RezBoost™, you'll see more detailed targets, with less clutter.

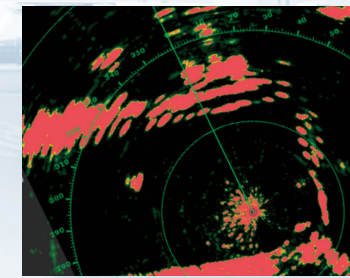

RezBoost™ standard

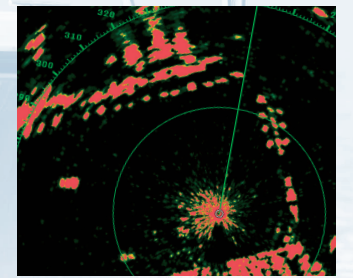

RezBoost™ Enhanced, MAX setting

NEW Bird Mode

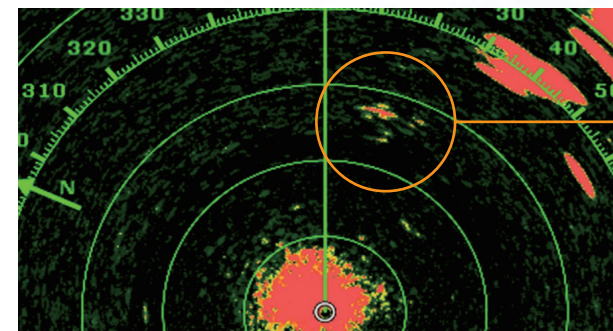

Bird echoes



Actual scene

DRS4D-NXT features a new bird mode that helps you identify birds gathering around schools of fish at the sea surface. Bird mode adjusts the gain and sea settings automatically for optimal visibility.

NEW Fast Target Tracking™

It only takes a few seconds after a target has been selected until a speed and course vector is displayed. With accurate tracking information, estimation of other vessel's course and speed is greatly simplified. With Fast Target Tracking™ activated, any vessel approaching yours will automatically display a target vector, as well as sound an alarm*. Up to 100 targets can be displayed simultaneously.

*TCPA setting required

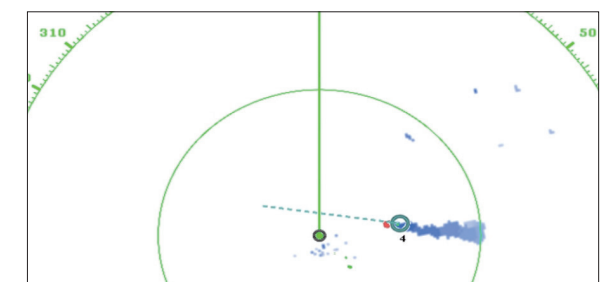

Approaching vessel with target vector

