



INSTRUCTION MANUAL

VHF MARINE TRANSCEIVER IC-M88

This device complies with Part 15 of the FCC Rules. Operation is subject to the follow two conditions: (1) This device may not cause harmful interference, and (2) this device must accept any interference received, including interference that may cause undesired operation.

Icom Inc.



SAFETY TRAINING INFORMATION



WARNING

Your Icom radio generates RF electromagnetic energy during transmit mode. This radio is designed for and classified as “Occupational Use Only”, meaning it must be used only during the course of employment by individuals aware of the hazards, and the ways to minimize such hazards. This radio is NOT intended for use by the “General Population” in an uncontrolled environment.

This radio has been tested and complies with the FCC RF exposure limits for “Occupational Use Only”. In addition, your Icom radio complies with the following Standards and Guidelines with regard to RF energy and electromagnetic energy levels and evaluation of such levels for exposure to humans:

- FCC OET Bulletin 65 Edition 97-01 Supplement C, Evaluating Compliance with FCC Guidelines for Human Exposure to Radio Frequency Electromagnetic Fields.
- American National Standards Institute (C95.1-1992), IEEE Standard for Safety Levels with Respect to Human Exposure to Radio Frequency Electromagnetic Fields, 3 kHz to 300 GHz.
- American National Standards Institute (C95.3-1992), IEEE Recommended Practice for the Measurement of Potentially Hazardous Electromagnetic Fields— RF and Microwave.



CAUTION

To ensure that your expose to RF electromagnetic energy is within the FCC allowable limits for occupational use, always adhere to the following guidelines:

- **DO NOT** operate the radio without a proper antenna attached, as this may damaged the radio and may also cause you to exceed FCC RF exposure limits. A proper antenna is the antenna supplied with this radio by the manufacturer or antenna specifically authorized by the manufacturer for use with this radio.

- **DO NOT** transmit for more than 50% of total radio use time (“50% duty cycle”). Transmitting more than 50% of the time can cause FCC RF exposure compliance requirements to be exceeded. The radio is transmitting when the “TX indicator” lights red. You can cause the radio to transmit by pressing the “PTT” switch.
- **ALWAYS use** Icom authorized accessories (antennas, batteries, belt clips, etc.). Use of unauthorized accessories can cause the FCC RF exposure compliance requirements to be exceeded.
- **ALWAYS keep** the antenna at least 2.5 cm (1 inch) away from the body when transmitting and only use the Icom belt-clips which are listed on page 31 when attaching the radio to your belt, etc., to ensure FCC RF exposure compliance requirements are not exceeded. To provide the recipients of your transmission the best sound quality, hold the antenna at least 5 cm (2 inches) from your mouth, and slightly off to one side.

The information listed above provides the user with the information needed to make him or her aware of RF exposure, and what to do to assure that this radio operates with the FCC RF exposure limits of this radio.

Electromagnetic Interference/Compatibility

During transmissions, your Icom radio generates RF energy that can possibly cause interference with other devices or systems. To avoid such interference, turn off the radio in areas where signs are posted to do so. **DO NOT** operate the transmitter in areas that are sensitive to electromagnetic radiation such as hospitals, aircraft, and blasting sites.

IN CASE OF EMERGENCY

If your vessel requires assistance, contact other vessels and the Coast Guard by sending a distress call on Channel 16.

○ **USING CHANNEL 16**

DISTRESS CALL PROCEDURE

1. "MAYDAY MAYDAY MAYDAY."
2. "THIS IS" (name of vessel)
3. Your call sign or other indication of the vessel.
4. "LOCATED AT" (your position)
5. The nature of the distress and assistance required.
6. Any other information which might facilitate the rescue.

RECOMMENDATION

CLEAN THE TRANSCEIVER THOROUGHLY WITH FRESH WATER after exposure to saltwater. Otherwise, the transceiver's keys, switches and controllers may become inoperable due to salt crystallization.

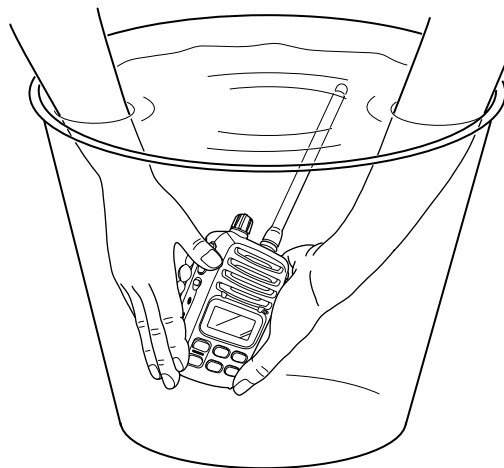

FOREWORD

Thank you for purchasing this Icom product. The IC-M88 VHF MARINE TRANSCEIVER is designed and built with Icom's state of the art technology and craftsmanship. With proper care this product should provide you with years of trouble-free operation.

IMPORTANT

READ ALL INSTRUCTIONS carefully and completely before using the transceiver.

SAVE THIS INSTRUCTION MANUAL—This instruction manual contains important operating instructions for the IC-M88.

EXPLICIT DEFINITIONS

WORD	DEFINITION
 WARNING	Personal injury, fire hazard or electric shock may occur.
CAUTION	Equipment damage may occur.
NOTE	If disregarded, inconvenience only. No risk of personal injury, fire or electric shock.

FEATURES

22 free channels for land use

The IC-M88 has 22 free channels reserved for Land use (146–174MHz). Wide/narrow channel spacing is programmable for each channel, and CTCSS and DTCS signaling is included.

*Appropriate license may be required.

Tough waterproof construction

The IC-M88 is built tough to withstand hazardous and inhospitable environments at sea and on land. Even if the IC-M88 is dropped into water, its waterproofing* will protect it from harm. The compact and durable body meets the military specifications (MIL-STD).

* Equivalent to JIS waterproof grade 7. (1m depth for 30 minutes)

Simple operation

6 clearly labelled buttons on the front panel and the volume/power knob maximize simplicity of operation. Even when wearing gloves, the large buttons are easy to operate. A large, clear LCD with backlighting and backlit buttons make night time operation simple.

Intrinsically safe (I/S) version available

PRECAUTION

⚠ WARNING! NEVER connect the transceiver to an AC outlet. This may pose a fire hazard or result in an electric shock.

⚠ WARNING! NEVER hold the transceiver so that the antenna is very close to, or touching exposed parts of the body, especially the face or eyes, while transmitting. The transceiver will perform best if the microphone is 5 to 10 cm (2 to 4 inches) away from the lips and the transceiver is vertical.

NEVER connect the transceiver to a power source other than the BP-226 or BP-227. Such a connection will ruin the transceiver.

AVOID using or placing the transceiver in direct sunlight or in areas with temperatures below -20°C (-4°F) or above $+60^{\circ}\text{C}$ ($+140^{\circ}\text{F}$): Marine, below -30°C (-22°F) or above $+60^{\circ}\text{C}$ ($+140^{\circ}\text{F}$): LMR.

KEEP the transceiver out of the reach of children.

KEEP the transceiver at least 0.9 meters (3.0 ft) away from your vessel's magnetic navigation compass.

BE CAREFUL! The IC-M88 employs waterproof construction, which corresponds to JIS waterproof specification, Grade 7 (1 m; 3 ft depth for 30 min.). However, once the transceiver has been dropped, waterproofing cannot be guaranteed due to the fact that the transceiver may be cracked, or the waterproof seal damaged, etc.

MAKE SURE the flexible antenna and battery pack are securely attached to the transceiver, and that the antenna and battery pack are dry before attachment. Exposing the inside of the transceiver to water will result in serious damage to the transceiver.

For U.S.A. only

CAUTION: Changes or modifications to this device, not expressly approved by Icom Inc., could void your authority to operate this device under FCC regulations.

Icom, Icom Inc. and  are registered trademarks of Icom Incorporated (Japan) in the United States, United Kingdom, Germany, France, Spain, Russia and/or other countries.

TABLE OF CONTENTS

SAFETY TRAINING INFORMATION	i
IN CASE OF EMERGENCY	ii
RECOMMENDATION	ii
FOREWORD	iii
IMPORTANT	iii
EXPLICIT DEFINITIONS	iii
FEATURES	iii
PRECAUTION	iv
TABLE OF CONTENTS	v
1 OPERATING RULES	1
2 SUPPLIED ACCESSORIES AND ATTACHMENTS....	2-3
3 PANEL DESCRIPTION	4-7
■ Front, top and side panels	4
■ Function display	6
4 BASIC OPERATION	8-12
■ Channel selection	8
■ Receiving and transmitting	10
■ Adjusting the squelch level	11
■ Automatic backlighting	11
■ Voice scrambler operation	11
■ Call channel programming	12
■ Lock function	12
5 SCAN OPERATION	13-14
■ Scan types	13
■ Setting tag channels	14
■ Starting a scan	14
6 DUALWATCH/TRI-WATCH	15
■ Description	15
■ Operation	15
7 LAND CHANNEL OPERATION	16
■ LAND Channel Group	16
■ Function display	16
8 SET MODE	17-21
■ SET mode programming	17
■ SET mode items	18
9 BATTERY CHARGING	22-26
■ Battery charging	22
■ Battery cautions	22
■ Optional BP-226 battery case	24
■ AD-100 installation	25
■ Optional battery chargers	26
10 SPEAKER-MICROPHONE	27
■ HM-138 Description	27
■ Attachments	27
11 TROUBLESHOOTING	28
12 VHF MARINE CHANNEL LIST	29
13 SPECIFICATIONS	30
14 QUICK REFERENCE	31
15 OPTIONS	33

◇ Priorities

- Read all rules and regulations pertaining to priorities and keep an up-to-date copy handy. Safety and distress calls take priority over all others.
- You must monitor Channel 16 when you are not operating on another channel.
- False or fraudulent distress calls are prohibited under law.

◇ Privacy

- Information overheard but not intended for you cannot lawfully be used in any way.
- Indecent or profane language is prohibited.

◇ Radio licenses

(1) SHIP STATION LICENSE

When your craft is equipped with a VHF FM transceiver, you must have a current radio station license before using the transceiver. It is unlawful to operate a ship station which is not licensed.

Inquire through your dealer or the appropriate government agency for a Ship-Radiotelephone license. This license includes the call sign which is your craft's identification for radio purposes.

(2) OPERATOR'S LICENSE

A restricted Radiotelephone Operator Permit is the license most often held by small vessel radio operators when a radio is not required for safety purposes.

The Restricted Radiotelephone Operator Permit must be posted near the transceiver or be kept with the operator. Only a licensed radio operator may operate a transceiver.

However, non-licensed individuals may talk over a transceiver if a licensed operator starts, supervises, ends the call and makes the necessary log entries.

A current copy of the applicable government rules and regulations is only required to be on hand for vessels in which a radio telephone is compulsory. However, even if you are not required to have these on hand it is your responsibility to be thoroughly acquainted with all pertinent rules and regulations.

NOTE: Even though the IC-M88 is capable of operation on VHF marine channels 3, 21, 23, 61, 64, 81, 82 and 83, according to FCC regulations these simplex channels cannot be lawfully used by the general public in USA waters.

◇ Supplied accessories

The following accessories are supplied: Qty.

- Swivel belt clip1
- Stopper for the swivel belt clip1
- Screws for the swivel belt clip2
- Flexible antenna1
- Handstrap1
- Battery pack (BP-227)1
- AC adapter (BC-147A/E)*1
- Battery charger (BC-152)1

*Depending on version

◇ Swivel belt clip

To attach:

- ① Attach the stopper to the back of the transceiver.

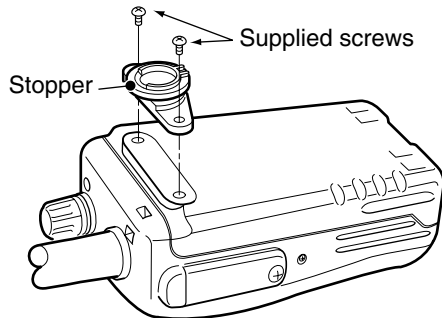

- ② Clip the belt clip to a part of your belt and insert the stopper to the belt clip.

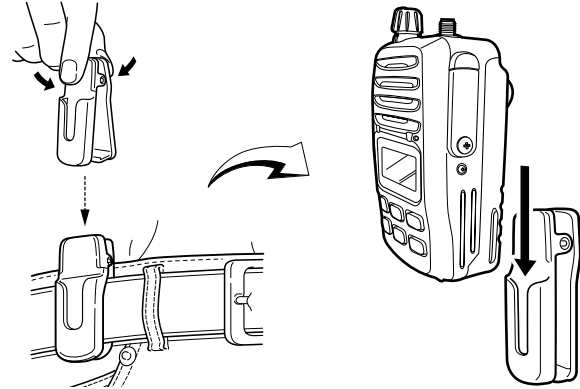

- ③ Once the transceiver is locked in place, it will swivel 360 degrees.

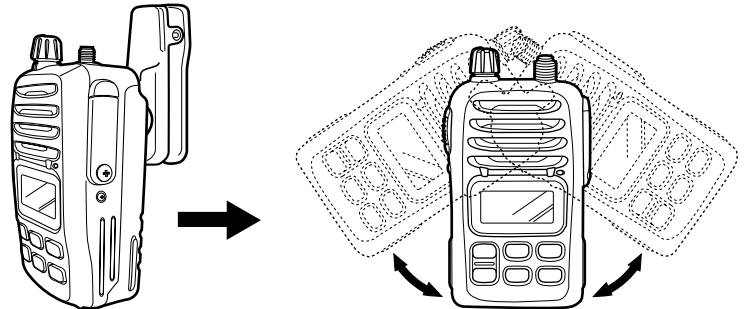

To remove:

Turn the transceiver upside down, and then lift up to release the transceiver from the belt clip.

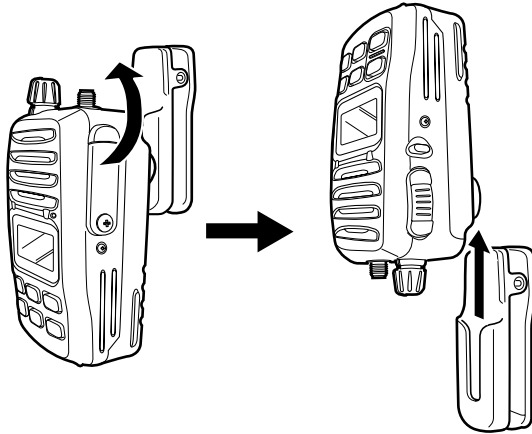

⚠ CAUTION!
HOLD THE TRANSCEIVER TIGHTLY, WHEN ATTACHING OR REMOVING THE TRANSCEIVER FROM THE BELT CLIP.

If the transceiver is accidentally dropped and the swivel belt clip's stopper is scratched or damaged, the swivel belt clip may not work properly.

◇ Flexible antenna

Connect the supplied flexible antenna to the antenna connector.

CAUTION: Transmitting without an antenna may damage the transceiver.

NEVER HOLD by the antenna when carrying the transceiver.

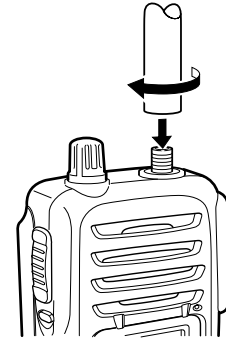

◇ Handstrap

Slide the handstrap through the loop on the side of the transceiver as illustrated at right. Facilitates carrying.

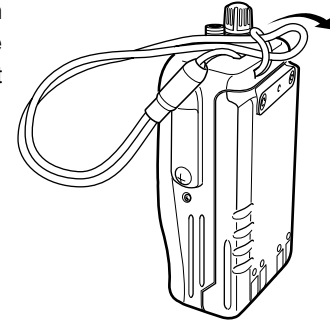

3

PANEL DESCRIPTION

■ Front, top and side panels

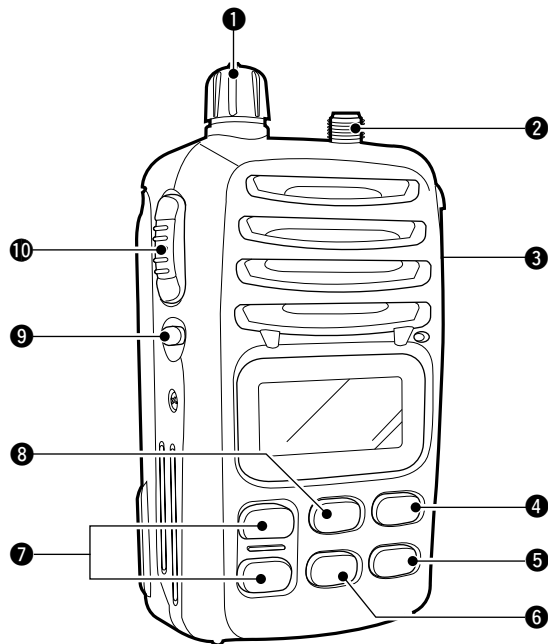

❶ VOLUME CONTROL [VOL]

Turns power ON and adjusts the audio level.

❷ ANTENNA CONNECTOR (p. 3)

Connects the supplied antenna.

❸ SPEAKER-MICROPHONE CONNECTOR [SP MIC] (p.27)

Connects the optional speaker-microphone.

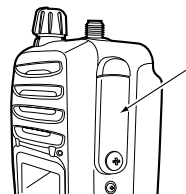

[SP MIC] jack cover

NOTE: KEEP the [SP MIC] jack cover attached to the transceiver when the speaker-microphone is not in use.

❹ SCAN [SCN•DUAL] (pgs. 14, 15)

- Starts and stops normal or priority scan.
- Enters Watch mode when pushed for 1 sec.

❺ TRANSMIT POWER/LOCK SWITCH [H/L•LOCK]

- Selects high, middle or low power when pushed. (p. 10)
- Toggles the lock function ON/OFF when pushed for 1 sec. (p. 12)

❻ CHANNEL 16 SWITCH [16•9]

- Selects Channel 16 when pushed. (p. 8)
- Selects the call channel when pushed for 1 sec. (p. 8)
- Enters call channel write mode when the call channel is selected and this switch is pushed for 3 sec. (p. 12)

7 CHANNEL UP/DOWN SWITCHES [▲]/[▼]

- Select an operating channel. (p. 9)
- Selects the SET mode condition of item. (p. 17)
- Checks tag channels or changes scanning direction during scan. (p. 14)
- Sets and clears the displayed channel as a tag (scanned) channel when pushed both switches for 1 sec.
- While turning power ON, clears all tag channels in the selected channel group when both switches are pushed.

8 CHANNEL/WEATHER CHANNEL SWITCH [CH/WX•U/M/C/L]

- Selects and toggles the regular channels and weather channel when pushed. (pgs. 8, 9, 16)
- Selects one of 4 regular channels in sequence when pushed for 1 sec. (pgs. 9, 16)
 - U.S.A., International, Canadian and Land channels are available.
- Push to return to the condition before selecting the channel when the priority channel or the call channel is selected.

9 SQUELCH SWITCH [SQL] (p. 11)

- Push this switch, then set the squelch level with [▲]/[▼].
- Manually opens the squelch for channel monitoring while pushed and held.
- While pushing this switch, turn the power ON to enter the set mode.

10 PTT SWITCH [PTT]

Push and hold to transmit; release to receive.

◇ BATTERY PACK RELEASE BUTTON

To release the battery pack:

Push the battery release button in the direction of the arrow (1) as shown below. The battery pack is then released.

To attach the battery pack:

Slide the battery pack on the back of the transceiver in the direction of the arrow (2), then lock it with the battery release button.

*Slide the battery pack until the battery release button makes a 'click' sound.

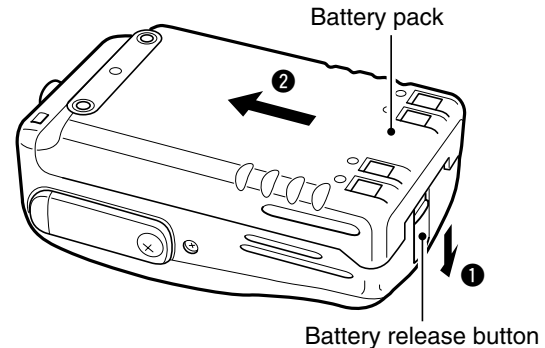

CAUTION! When pushing the battery release button, slide the battery pack slightly in the direction of the arrow (2) to ease release. This will prevent possible injuring to your fingers or nails

3 PANEL DESCRIPTION

■ Function display

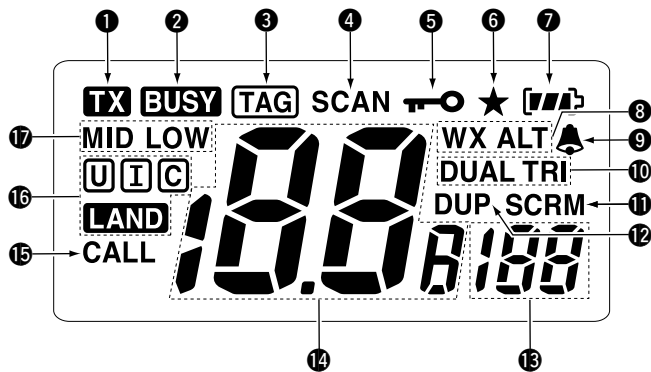

- 1 TRANSMIT INDICATOR** (p. 10)
 Appears while transmitting.
- 2 BUSY INDICATOR** (p. 10)
 Appears when receiving a signal or when the squelch opens.
 “ **BUSY** ” blinks while monitoring.
- 3 TAG CHANNEL INDICATOR** (p. 14)
 Appears when a tag channel is selected.
- 4 SCAN INDICATOR** (p. 14)
 Blinks while scanning.
- 5 LOCK INDICATOR** (p. 12)
 Appears while the lock function is activated.
- 6 NARROW INDICATOR** (p. 16)
 Appears when narrow channel spacing is selected. (LAND channel group only)
- 7 BATTERY INDICATOR**
 Indicates remaining battery power.

Indication	[]	[]	[]	[]
Battery level	Full	Middle	Charging required	Discharged

8 WEATHER CHANNEL/WEATHER ALERT INDICATORS

- “WX” appears when the weather channel group is selected. (p. 9)
- “ALT” appears while the weather alert function is activated.

9 BELL INDICATOR

Blinks when an alert tone is received.

10 DUALWATCH/TRI-WATCH INDICATORS (p. 15)

“DUAL” appears during dualwatch; “TRI” appears during tri-watch.

11 SCRAMBLER INDICATOR (Available for I/S version only)

Appears when the optional voice scrambler is activated. (pgs. 11, 21)

12 DUPLEX INDICATOR

Appears when a duplex channel is selected.

13 SUB CHANNEL READOUT

- Indicates Channel 16 during priority scan, dualwatch or tri-watch. (p. 15).
- Indicates the SET mode item while in SET mode.

14 CHANNEL NUMBER READOUT

- Indicates the selected operating channel number.
- In SET mode, indicates the selected condition.

15 CALL CHANNEL INDICATOR (p. 8)

Appears when the call channel is selected.

16 CHANNEL GROUP INDICATOR (pgs. 9, 16)

“U” appears when U.S.A.; “I” appears when International; “C” appears when Canadian; “LAND” appears when LAND channel group is selected.

17 TRANSMIT POWER INDICATOR (p. 10)

- “LOW” appears when low power is selected.
- “MID” appears when middle power is selected.
- No indication when high power is selected.

■ Channel selection

◇ Channel 16

Channel 16 (Distress channel) is used for establishing initial contact with another station and for emergency communications. Channel 16 is automatically monitored during both dualwatch and tri-watch. While standing by, you must monitor Channel 16.

- ① Push [16•9] to select Channel 16.
- ② Push [CH/WX•U//C/L] to return to the condition before selecting Channel 16, or push [▲]/[▼] to select the operating channel.

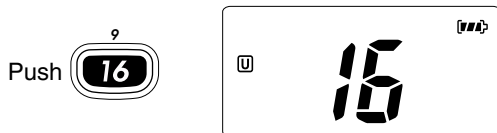

◇ Channel 9 (Call channel)

Channel 9 is the leisure-use call channel. Each regular channel group has separate call channels. In addition, each call channel is monitored during tri-watch. The call channels can be reprogrammed (p. 12) and are used to store your most often used channels in each channel group for quick recall.

- ① Push [16•9] for 1 sec. to select the call channel in the selected channel group.
 - “CALL” and the call channel number appear.
 - Each channel group may have its own call channel after programming a call channel. See the “Call channel programming” on p. 12 for details.
- ② Push [CH/WX•U//C/L] to return to the condition before selecting Channel 9 (call channel), or push [▲]/[▼] to select the operating channel.

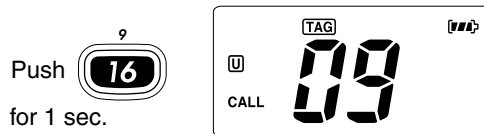

◇ **U.S.A., International and Canadian channels**

There are 57 U.S.A., 57 International, and 61 Canadian channels. These channel groups may be specified for the operating area.

- ① Push [CH/WX•U/I/C/L] to select a regular channel.
 - If a weather channel appears, push [CH/WX•U/I/C/L] again.
- ② Push [▲]/[▼] to select a channel.
 - “DUP” appears for duplex channels.
- ③ To change the channel group, push [CH/WX•U/I/C/L] for 1 sec.
 - U.S.A., International and Canadian channels can be selected in sequence. Depending on the setting, LAND channel can be selected. See the “LAND CHANNEL OPERATION” on p. 16 for details.

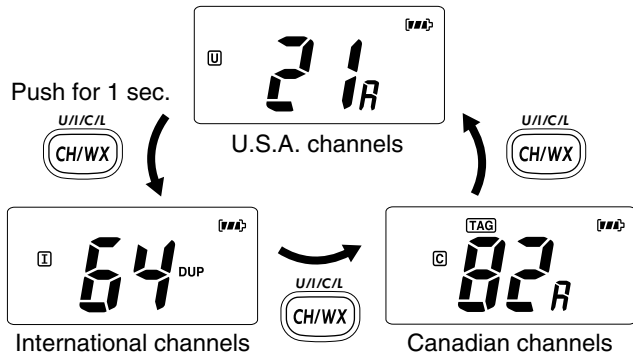

◇ **Weather channels** (Available for USA version only)

There are 10 weather channels. They are used for monitoring weather channels from the NOAA (National Oceanographic and Atmospheric Administration) broadcasts.

- ① Push [CH/WX•U/I/C/L] to select the weather channel group.
- ② Push [▲]/[▼] to select a weather channel.
- ③ Push [CH/WX•U/I/C/L] to return to the condition before selecting the weather channel group.

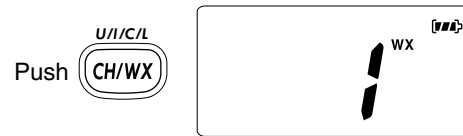

/// **For your convenience:** The IC-M88 can detect a weather alert tone on the selected weather channel while receiving in another channel or during scanning. See the “SET mode items” on p. 18 for details.

4 BASIC OPERATION

■ Receiving and transmitting

CAUTION: Transmitting without an antenna may damage the transceiver.

- ① Rotate [VOL] clockwise to turn power ON.
- ② Use the squelch function to mute any audio noise if necessary. After pushing the [SQL] for 1 sec., the squelch function is cut off until [SQL] is released. (default)
- ③ Push [SQL] for 1 sec. (see the SET mode on p. 19), and rotate volume to set the audio output level.
- ④ Push [▲]/[▼] to select the desired channel.
 - When receiving a signal, “**BUSY**” appears and audio is emitted from the speaker.
 - Further adjustment of [VOL] may be necessary at this point.
- ⑤ Push [H/L•LOCK] to select the output power if necessary.
 - “LOW” appears when low power is selected; “MID” appears when middle power is selected; no indication when high power is selected.
 - Choose low power to conserve battery power, choose high power for longer distance communications.
 - Some channels are for low power only.
- ⑥ Push and hold [PTT] to transmit, then speak into the microphone.
 - “TX” appears.
 - Channel 70 cannot be used for transmission (for GMDSS use).
- ⑦ Release [PTT] to receive.

IMPORTANT: To maximize the readability of your transmitted signal, pause a few sec. after pushing [PTT], hold the microphone 5 to 10 cm (2 to 4 inches) from your mouth and speak at a normal voice level.

NOTE: The transceiver has a power save function to conserve the battery power and it cannot be turned OFF. The power save function activates automatically when no signal is received for 5 sec.

For U.S.A version: To prevent accidental prolonged transmission, etc., the IC-M88 has a time-out timer function. This timer cuts a transmission OFF after 5 min. of continuous transmission.

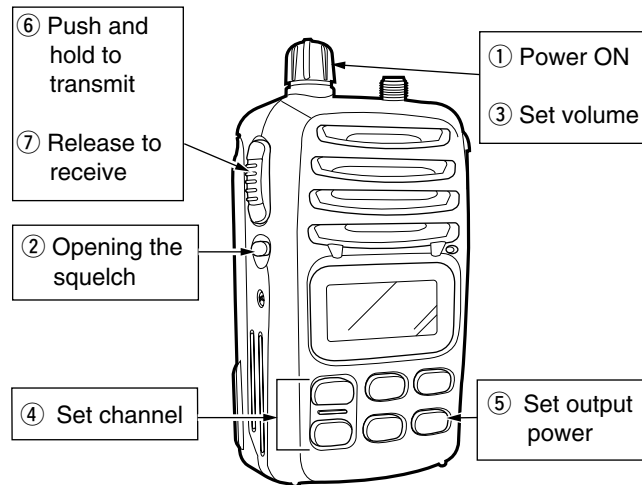

■ Adjusting the squelch level

The IC-M88 has a squelch even though there is no control knob for it. In order to receive signals properly, as well as for the scan to function effectively, the squelch must be adjusted to the proper level.

- ① Push [SQL], then adjust the squelch level with [▲]/[▼].
 - “SL” indicator appears.
 - There are 11 squelch levels to choose from: OP is completely open; 10 is the tight squelch level.
 - When no key is pushed for 5 sec., the transceiver returns to normal condition.
- ② Push [SQL] again to return to normal condition.

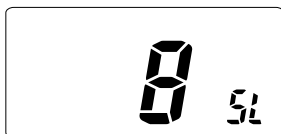

■ Automatic backlighting

This function is convenient for nighttime operation. The automatic backlighting can be activated in SET mode. (p. 19)

- ➡ Push any key except for [PTT] to turn the backlighting ON.
 - The backlighting is automatically turned OFF after 5 sec. of inactivity.

■ Voice scrambler operation

(Available for I/S version only)

◇ Activating the scrambler

The optional voice scrambler provides private communications. In order to receive or send scrambled transmissions, you must first activate the scrambler function.

- ① Select an operating channel except Channel 16, 70 or weather channels.
- ② While pushing and holding [SQL], push [SCN•DUAL].
 - “SCRM” appears.
- ③ To turn the scrambler function OFF, repeat step ②.
 - “SCRM” disappears.



Appears when the voice scrambler function is in use.

◇ Programming scramble codes

There are 32 codes (1 to 32) available for programming. Set the code in SET mode. In order to understand each other, all transceivers in your group must have the same scramble code, as well as the same scrambler unit. See page 21 for scrambler code setting details.

4 BASIC OPERATION

■ Call channel programming

The call channel key is used to select Channel 9 by default, however, you can program your most often-used channels in each channel group for quick recall.

- ① Push [CH/WX•U//C/L] for 1 sec. several times to select the desired channel group (USA, INT, CAN) to be programmed.
- ② Push [16•9] for 1 sec. to select the call channel.
 - “CALL” and call channel number appear.
- ③ Push [16•9] again for 3 sec. (until a long beep changes to 2 short beeps) to enter call channel programming condition.
 - Call channel number to be programmed flashes.
- ④ Push [▲]/[▼] to select the desired channel.



- ⑤ Push [16•9] to program the displayed channel as the call channel.
 - The call channel number stop flashing.



■ Lock function

This function electronically locks all keys (except for [PTT], [SQL] and [H/L•LOCK]) to prevent accidental channel changes and function access.

- Push [H/L•LOCK] for 1 sec. to turn the lock function ON and OFF.



Appears while the lock function is used.

■ Scan types

Scanning is an efficient way to locate signals quickly over a wide frequency range. The transceiver has priority scan and normal scan.

In addition, the weather alert and auto scan function is available for standby convenience. These functions can be activated simultaneously, depending on the settings in SET mode. (pgs. 18, 19)

Set the tag channels (scanned channel) before scanning. Clear the tag channels which inconveniently stop scanning, such as digital communications.

/// Choose priority or normal scan in SET mode. (p. 18)

PRIORITY SCAN

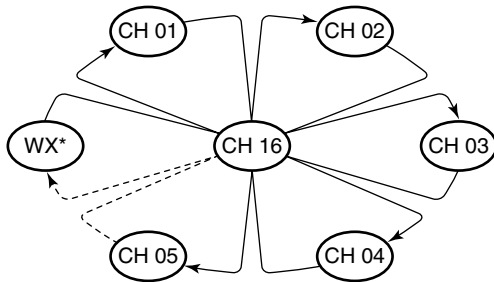

* Previously selected weather channel when weather alert function is ON

Priority scan searches through all tag channels in sequence while monitoring Channel 16. When a signal is detected on Channel 16, scan pauses until the signal disappears; when a signal is detected on a channel other than Channel 16, scan becomes dualwatch until the signal disappears.

NORMAL SCAN

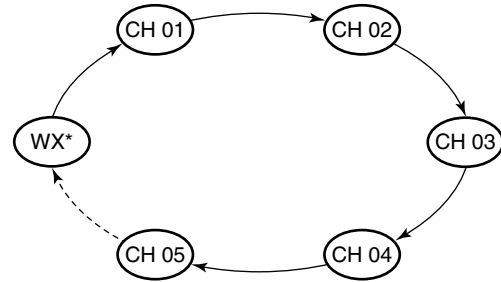

* Previously selected weather channel when weather alert function is ON.

Normal scan, like priority scan, searches through all tag channels in sequence. However, unlike priority scan, Channel 16 is not checked unless Channel 16 is set as a tag channel.

5 SCAN OPERATION

■ Setting tag channels

For more efficient scanning, add desired channels as tag channels or clear tag channels for unwanted channels. Non-tag channels will be skipped during scanning. Tag channels can be assigned to each channel group (USA, INT, CAN) independently.

- ① Select the desired channel group (USA, INT, CAN) by pushing [CH/WX•U/I/C/L] for 1 sec., if desired.
- ② Select the desired channel to set as a tag channel.
- ③ Push both [▲] and [▼] for 1 sec. to set the displayed channel as a tag channel.
 - “TAG” appears in the function display.
- ④ To cancel the tag channel setting, push both [▲] and [▼] for 1 sec.
 - “TAG” disappears.

• **Clearing all tag channels in the selected channel group**
While pushing and holding both [▲] and [▼], turn power ON to clear all tag channels in the channel group.

■ Starting a scan

Set the weather alert function, priority scan function, scan resume timer and auto scan function in advance, using SET mode. (pgs. 18, 19)

- ① Select the desired channel group (USA, CAN, INT) by pushing [CH/WX•U/I/C/L] for 1 sec., if desired.
 - When the weather alert function is in use, select the desired weather channel with [CH/WX•U/I/C/L] and [▲]/[▼].
- ② Push [SCN•DUAL] to start priority or normal scan.
 - “SCAN” blinks in the function display.
 - “16” appears during priority scan.
 - When a signal is received, scan pauses until the signal disappears or resumes after pausing 5 sec. according to SET mode setting. (Channel 16 is still monitored during priority scan.)
 - Push [▲]/[▼] to check the scanning tag channels, to change the scanning direction or resume the scan manually.
- ③ To stop the scan, push [SCN•DUAL].
 - “SCAN” disappears.
 - Pushing [PTT], [16•9] or [CH/WX•U/I/C/L] also stops the scan.

[Example]: Starting a normal scan.

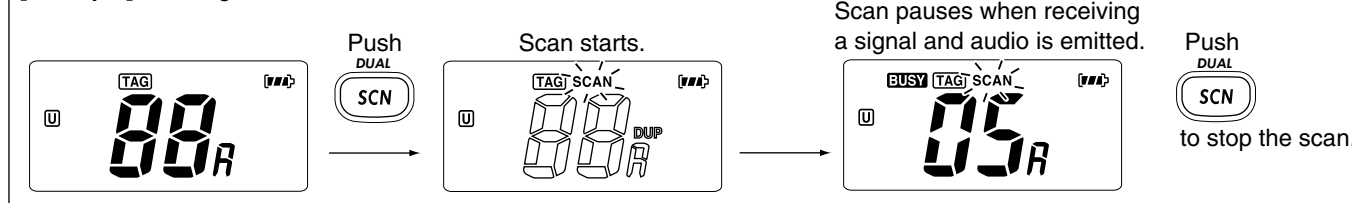

■ Description

Dualwatch monitors Channel 16 while you are receiving another channel; tri-watch monitors Channel 16 and the call channel while receiving another channel.

DUALWATCH/TRI-WATCH SIMULATION

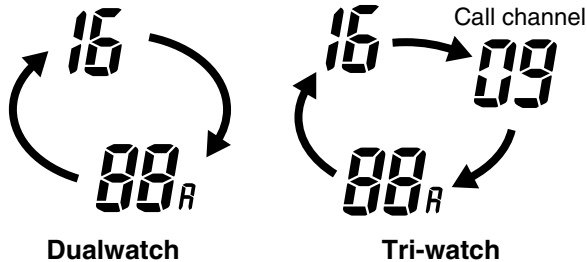

- If a signal is received on Channel 16, dualwatch/tri-watch pauses on Channel 16 until the signal disappears.
- If a signal is received on the call channel during tri-watch, tri-watch becomes dualwatch until the signal disappears.
- To transmit on the selected channel during dualwatch/tri-watch, push and hold [PTT].
- If no signal is received, the transceiver enters the power saving condition for 0.5 sec. after checking the operating channel every cycle.

■ Operation

- ① Select the desired operating channel.
- ② Push [SCN•DUAL] to start dualwatch or tri-watch (depending on SET mode setting).
 - “DUAL” blinks during dualwatch; “TRI” blinks during tri-watch.
 - A beep tone sounds when a signal is received on Channel 16.
 - Tri-watch becomes dualwatch when receiving a signal on the call channel.
- ③ To cancel dualwatch/tri-watch, push [SCN•DUAL] again.

[Example]: Operating tri-watch on INT channel 07.

Push for 1 sec.



Tri-watch starts.



Signal is received on call channel.

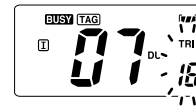

Signal received on Channel 16 takes priority.



Tri-watch resumes after the signal disappears.

■ LAND Channel Group

A max. of 22 free LAND mobile channels (allocated 146.000 to 174.000 MHz) can be programmed into the LAND channel group for simple communication with LMR transceivers in the VHF band.

Moreover, any of the marine channels in the USA, INT and CAN channel groups can be programmed.

The default setting of the LAND channel group is the same as that of the INT channel group. Ask your local Icom dealer for the LAND channel group setting and LMR frequency programming details.

- ① Push [CH/WX•U/I/C/L] to select a regular channel.
 - If a weather channel appears, push [CH/WX•U/I/C/L] again.
- ② To change the channel group, push [CH/WX•U/I/C/L] for 1 sec several times.
 - “LAND” appears when LAND channel group is selected.
- ③ Push [▲]/[▼] to select a channel.
 - “DUP” appears for duplex channels.

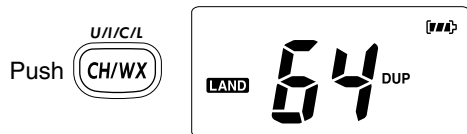

NOTE: The basic settings (e.g. call channel programming) are same as the U.S.A., International and Canadian channels. Refer to the appropriate pages for details.

■ Function display

When Narrow, DTCS or CTCSS is set, the display shows the indications as below.

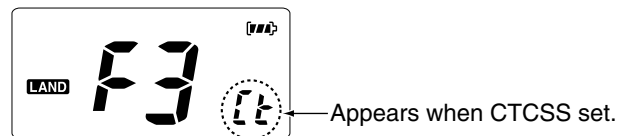
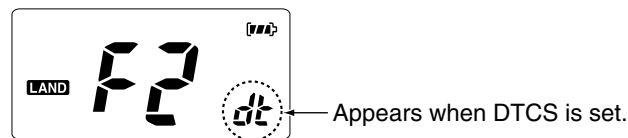
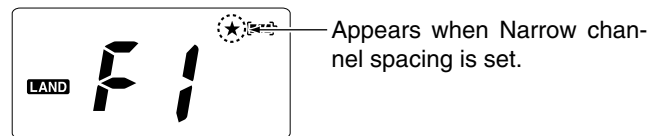

■ SET mode programming

SET mode is used to change the condition of 13 transceiver functions: beep tone function, weather alert function, priority scan function, scan resume timer, auto scan function, dual/tri-watch function, monitor switch action, automatic backlighting, LCD contrast selection, auto power save function, self check function, battery voltage indicator and scrambler code*.

◇ SET mode operation

- ① Turn power OFF.
- ② While pushing [SQL], turn power ON to enter SET mode.
 - “bp” appears.
- ③ Push [SQL] to select the desired item, if necessary.
- ④ Push [▲]/[▼] to select the desired condition of the item.
- ⑤ To exit SET mode, push [16•9].

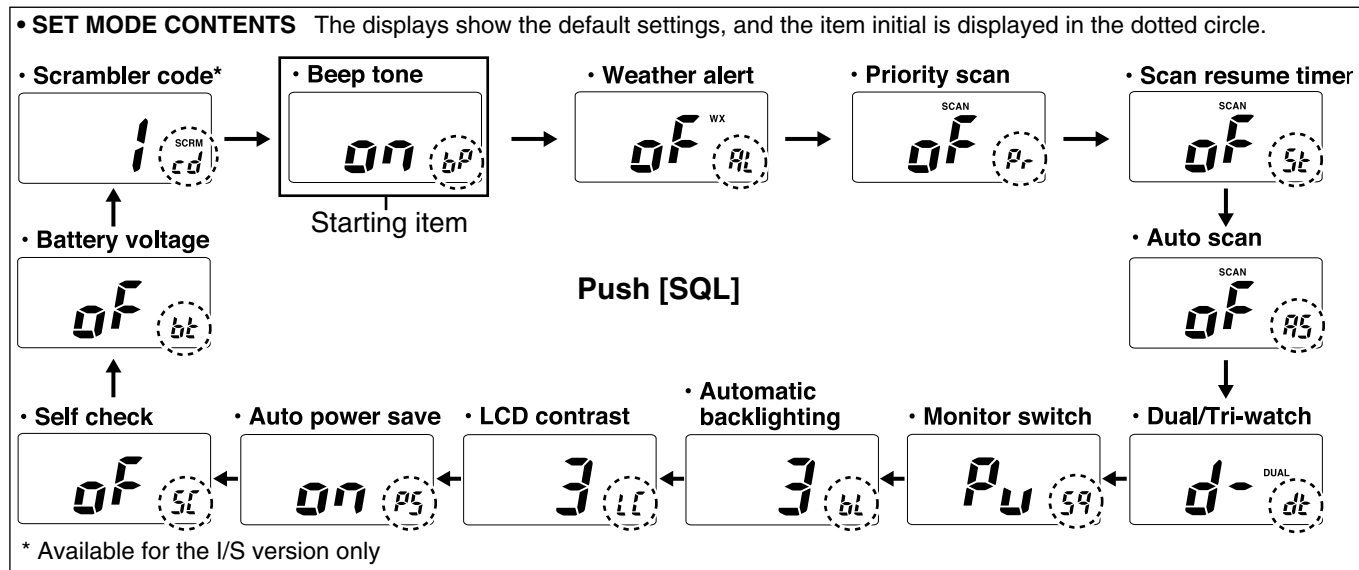

8 SET MODE

■ SET mode items

◇ Beep tone function “bP”

You can select silent operation by turning the beep tones OFF, or you can have 2 types of confirmation beeps sound at the push of a switch. When ON is selected, a fixed beep (Pi) sounds and when US is selected, the preset beeps (e.g. do, re, mi) sound.



Beep tone ON (default)



User Beep

◇ Weather alert function “AL”

An NOAA broadcast station transmits a weather alert tone before any important weather announcements. When the weather alert function is turned ON, the transceiver detects the alert, the bell indicator blinks and sounds a beep tone until the transceiver is operated. The previously selected (used) weather channel is checked any time during standby, or while scanning, when the power save function is activated.

• “ALT” appears when the function is set ON.

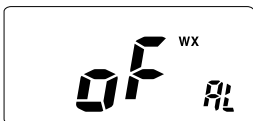

Weather alert function OFF (default)

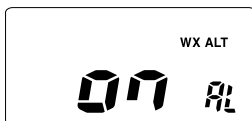

Weather alert function ON

◇ Priority scan function “Pr”

The transceiver has 2 scan types—normal and priority scans. Normal scan searches all tag channels in the selected channel group. Priority scan searches all tag channels in sequence while monitoring Channel 16.



Normal scan (default)

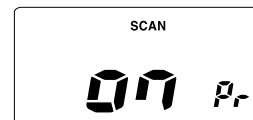

Priority scan

◇ Scan resume timer “St”

The scan resume timer can be set as a pause (OFF) or timer scan (ON). When OFF is selected, the scan pauses until a received signal disappears. When ON is selected, the scan pauses for 5 sec. after receiving a signal and then resumes even if the signal has been received.



Scan resume timer OFF (default)



Scan resume timer ON

◇ **Auto scan function “AS”**

The Auto scan function starts the desired scan automatically when no signal is received, or no operation is performed for 30 sec.



Auto scan OFF (default)



Auto scan ON

◇ **Dual/Tri-watch function “dt”**

This item selects dual or tri-watch as desired. See p. 15 for details.

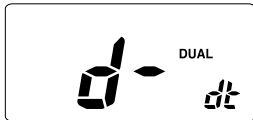

Dualwatch function
(default)

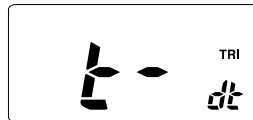

Tri-watch function

◇ **Monitor switch action “Sq”**

The monitor switch action cuts off the squelch function temporarily. This switch action contains PUSH (Pu) or HOLD (Ho) settings as shown below.

- Pu (PUSH): After pushing the [SQL] for 1 sec., the squelch opens and emits audio while pushing and holding [SQL]. (default)
- Ho (HOLD): After pushing the [SQL] for 1 sec., the squelch opens and emits audio even [SQL] is released. To close the squelch, push any key.



Monitor action PUSH
(default)



Monitor action Hold

◇ **Automatic backlighting “bL”**

This function is convenient for nighttime operation. The automatic backlighting can be adjusted from OFF, 1 (dark)–3 (bright); 3 (default). Select 1–3 to turn this function ON.

- The automatic backlighting turns the backlighting ON when any key except for [PTT] is pushed.
- The backlighting is automatically turned OFF after 5 sec. of inactivity.



Automatic backlighting
(default)



Automatic backlighting
OFF

8 SET MODE

◇ LCD contrast selection “LC”

The contrast of the LCD can be adjusted from 4 levels.

- 1 (bright) – 4 (dark); 3 (default)

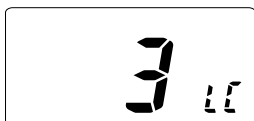

LCD contrast 3 (default)

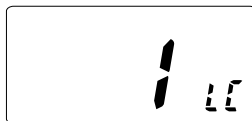

LCD contrast 1

◇ Auto power save function “PS”

The auto power save function reduces current drain by deactivating the receiver circuit for preset intervals.



Auto power save ON
(default)



Auto power save OFF

◇ Self check function “SC”

The self check function checks transceiver conditions by itself, and informs you in case a problem is found. The following items are checked after the power is turned ON, then it switches to operation mode.

- Temperature : Outside of -35°C to $+73^{\circ}\text{C}$; -31°F to $+163^{\circ}\text{F}$ (approx.)
- Connected battery voltage
- Water intrusion



Self check OFF (default)



Self check ON

When error messages as shown below are displayed, see trouble shooting for advice (p. 28).

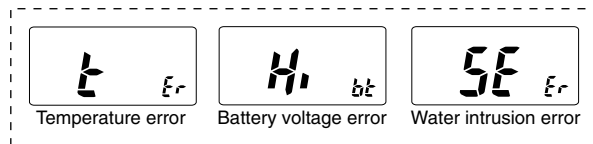

◇ **Battery voltage indicator “bt”**

This function contains display or non-display settings of the voltage of the connected battery pack when the power is ON.

- The voltage of the connected battery pack is displayed for 2 sec. after power is turned ON.



Battery voltage OFF (default)



Battery voltage ON

◇ **Scrambler code “cd”** (Available for I/S version only)

There are 32 codes (1 to 32) available for programming. In order to understand each other, all transceivers in your group must have the same scramble code.

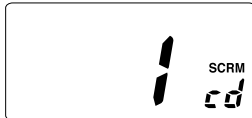

Scrambler code 1 (default)



Scrambler code 32

SET MODE LIST

Function	Indication	Switch
Beep tone function	"bP"	OFF / ON* / US
Weather alert function	"AL"	OFF* / ON
Priority scan function	"Pr"	OFF* / ON
Scan resume timer	"St"	OFF* / ON
Auto scan function	"AS"	OFF* / ON
Dual/Tri-watch function	"dt"	Dual* / Tri
Monitor switch action	"Sq"	Push* / Hold
Automatic backlighting	"bL"	OFF / 1 / 2 / 3*
LCD contrast selection	"LC"	1 / 2 / 3* / 4
Auto power save function	"PS"	OFF / ON*
Self check function	"SC"	OFF* / ON
Battery voltage indicator	"bt"	OFF* / ON
Scrambler code**	"cd"	1* / 2 / ··· / 32

* default setting

** Available for I/S version only

■ Battery charging

Prior to using the transceiver for the first time, the battery pack must be fully charged for optimum life and operation.

CAUTION: To avoid damage to the transceiver, turn it OFF while charging.

- Recommended temperature range for charging:
+10°C to +40°C (+50°F to +104°F)
- The Li-Ion battery is functioning within -20°C to +60°C (-4°F to +140°F)
- Use the specified chargers (BC-119N, BC-121N and BC-152). **NEVER** use another manufacturer's charger.
- Use the supplied AC adapter (BC-147A/E) for BC-152. **NEVER** use another manufacturer's AC adapter.

Recommendation:

Charge the supplied battery pack for a maximum of up to 10 hours. Li-Ion batteries are different from Ni-Cd batteries in that it is not necessary to completely charge and discharge them to prolong the battery life. Therefore, charging the battery in intervals, and not for extended periods is recommended.

■ Cautions

NEVER incinerate used battery packs. Internal battery gas may cause an explosion.

NEVER immerse the battery pack in water. If the battery pack becomes wet, be sure to wipe it dry immediately (particularly the battery terminals) **BEFORE** attaching it to the transceiver. Otherwise, the terminals will become corroded, or cause connection failure, etc.

NEVER short the terminals of the battery pack. Also, current may flow into nearby metal objects, such as a necklace, etc. Therefore, be careful when carrying with, or placing near metal objects, carrying in handbags, etc.

AVOID leaving the battery pack in a fully charged, or completely discharged condition for long time. It causes shorter battery life. In case of leaving the battery pack unused for a long time, it must be kept safely after discharge, or use the battery until the battery indicator shows the middle level, then remove it from the transceiver.

If your battery pack seems to have no capacity even after being charged, completely discharge it by leaving the power ON overnight. Then, fully charge the battery pack again. If the battery pack still does not retain a charge (or very little), a new battery pack must be purchased.

◆ Charging connections

- ① Attach the BC-152 to a flat surface, such as desk or cabin, etc., if desired.
- ② Connect the AC adapter (BC-147A/E) as shown below.
- ③ Insert the battery pack with/without the transceiver into the charger.
 - The charge indicator lights green.
- ④ Charge the battery pack approx. 9–10 hours, depending on the remaining power condition.

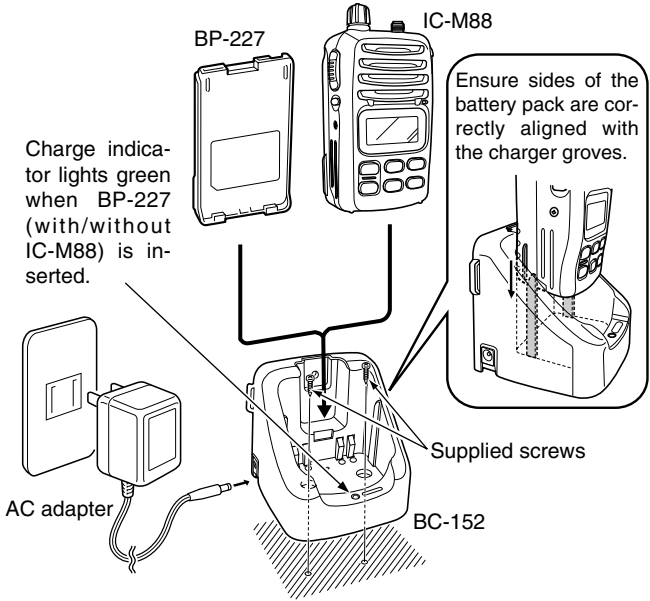

• For your convenience:

Eyelet: USE a rubber band to secure the transceiver, if desired.

9 BATTERY CHARGING

■ Optional BP-226 battery case

When using the optional battery case attached to the transceiver, install 5 × AA (R6) size alkaline batteries as illustrated at right. The IC-M88 meets JIS waterproof specification grade 7. However, the BP-226 meets JIS waterproof specification grade 4.

- ① Hook your finger under the latch, and open the cover in the direction of the arrow (➊). (Fig.1)
- ② Then, install 5 × AA (R6) size alkaline batteries. (Fig.2)
 - Install the alkaline batteries only.
 - Be sure to observe the correct polarity.
 - Do not pin the ribbon under the batteries.
- ③ Close the cover with fitting in the direction of the arrow (➋) first, then firm the latch in place (➌). (Fig.1)
 - Be sure to the gasket and the ribbon are set correctly, and do not protrude out of the battery case. (Fig.3)

CAUTION:

- When installing batteries, make sure they are all the same brand, type and capacity. Also, do not mix new and old batteries together.
- Keep battery contacts clean. It's a good idea to clean battery terminals once a week.

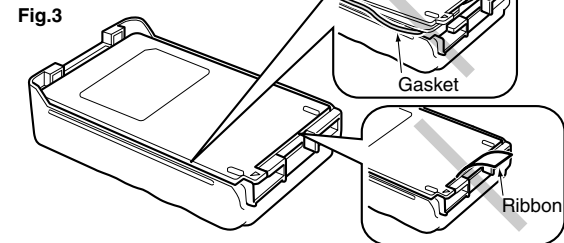
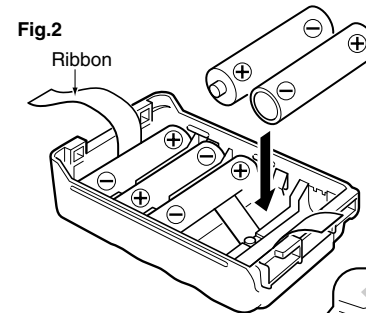
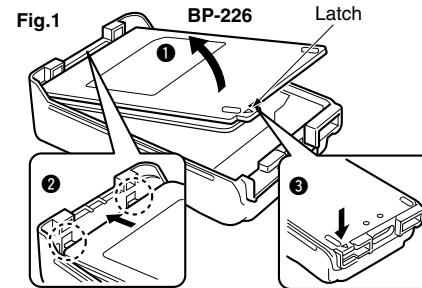

■ AD-100 installation

Install the AD-100 desktop charger adapter into the holder space of the BC-119N/121N.

Connect the plugs of the BC-119N/121N to the AD-100 desktop charger adapter with the connector, then install the adapter into the charger with the supplied screws.

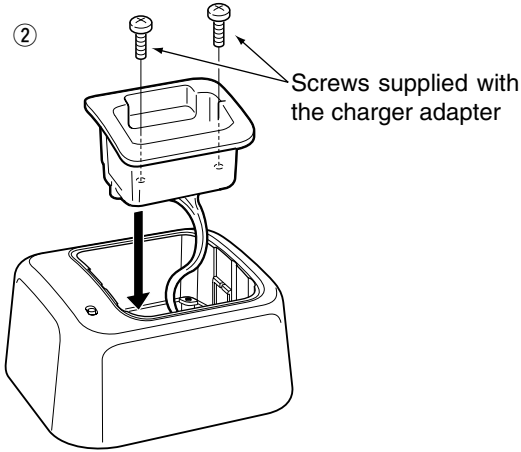
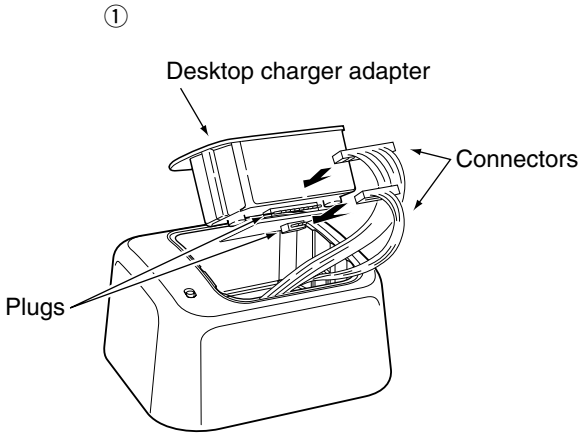

9 BATTERY CHARGING

■ Optional battery chargers

◇ Rapid charging with the BC-119N+AD-100

The optional BC-119N provides rapid charging of battery packs. The following are additionally required.

- AD-100 charger adapter
- An AC adapter (may be supplied with BC-119N depending on version).

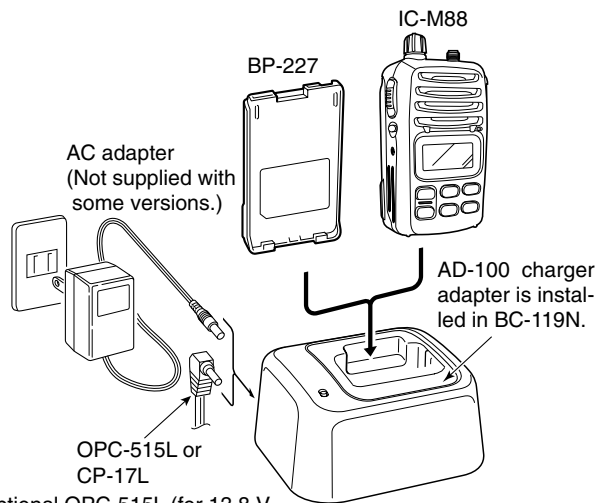

Optional OPC-515L (for 13.8 V power source) or CP-17L (for 12 V cigarette lighter socket) can be used instead of the AC adapter.

◇ Rapid charging with the BC-121N+AD-100

The optional BC-121N allows up to 6 battery packs to be charged simultaneously. The following are additionally required.

- Six AD-100 charger adapters
- An AC adapter (BC-124) or the DC power cable OPC-656, supplied with the BC-121N.

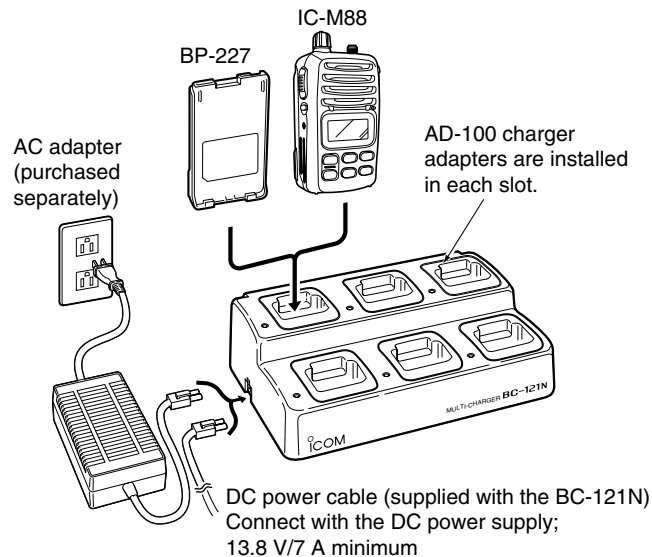

SPEAKER-MICROPHONE 10

■ HM-138 Description

Alligator type clip

To attach the speaker-mic. to your shirt or collar, etc.

PTT switch

Transmits during push
Receives during release

Microphone

Speaker

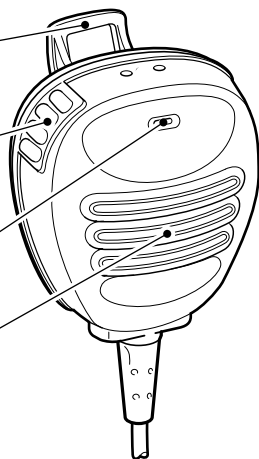

NEVER immerse the connector in water. If the connector becomes wet, be sure to dry it **BEFORE** attaching it to the transceiver.

NOTE: The microphone is located at the top of the speaker-microphone, as shown in the diagram above. To maximize the readability of your transmitted signal (voice), hold the microphone approx. 5 to 10 cm (2 to 4 inches) from your mouth, and speak in a normal voice level.

■ Attachments

Insert the connector of the speaker-microphone into the [SP MIC] connector on the transceiver and tighten the screw.

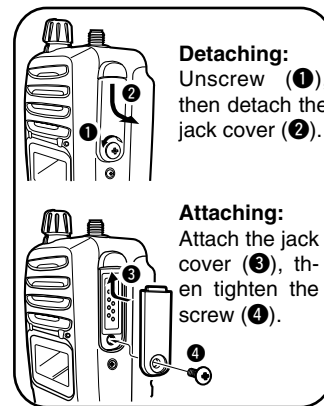
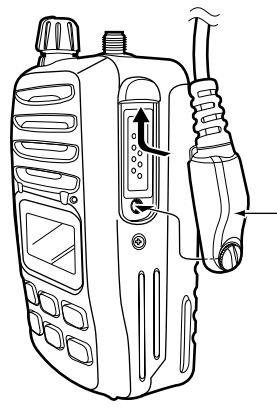

Detaching:

Unscrew (1), then detach the jack cover (2).

Attaching:

Attach the jack cover (3), then tighten the screw (4).

CAUTION: Attach the speaker-microphone's connector securely to prevent accidental dropping, or water intrusion in the connector.

IMPORTANT: KEEP the [SP MIC] jack cover attached (transceiver) when the speaker-microphone is not in use as illustrated above. Water will not get into the transceiver even if the cover is not attached, however, the terminals (pins) will become rusty, or the transceiver will function abnormally if the connector becomes wet.

11 TROUBLESHOOTING

PROBLEM	POSSIBLE CAUSE	SOLUTION.	REF.
The transceiver does not turn ON.	<ul style="list-style-type: none"> • The battery is exhausted. • Bad connection to the battery pack. 	<ul style="list-style-type: none"> • Recharge the battery pack. • Check the connection to the transceiver. 	p. 22 p. 5
No sound from speaker.	<ul style="list-style-type: none"> • Squelch level is too deep. • Volume level is too low. • Speaker has been exposed to water. 	<ul style="list-style-type: none"> • Set squelch to the threshold point. • Set [VOL] to a suitable level. • Drain water from the speaker. 	p. 11 p. 10 —
Transmitting is impossible, or high power cannot be selected.	<ul style="list-style-type: none"> • Some channels are for low power or receive only. • The battery is exhausted. • The output power is set to low. 	<ul style="list-style-type: none"> • Change channels. • Recharge the battery pack. • Push [H/L•LOCK] to select high power. 	pgs. 8, 9, 29 p. 22 p. 10
The displayed channel cannot be changed.	<ul style="list-style-type: none"> • Lock function is activated. 	<ul style="list-style-type: none"> • Push [H/L•LOCK] for 1 sec. to cancel the function. 	p. 12
Scan does not start.	<ul style="list-style-type: none"> • “TAG” channels are not programmed. 	<ul style="list-style-type: none"> • Set the desired channels as “TAG” channels. 	p. 14
No beeps.	<ul style="list-style-type: none"> • Beep tones are turned OFF. 	<ul style="list-style-type: none"> • Set the beep tones to ON (Fix Beep/User Beep) in SET mode. 	p. 18
Self check error. (Temperature)	<ul style="list-style-type: none"> • The temperature is outside of -35°C to $+73^{\circ}\text{C}$; -31°F to $+163^{\circ}\text{F}$ (approx) 	<ul style="list-style-type: none"> • Leave the transceiver at room temperature for a while. Turn the power ON to check if the internal temperature has returned to normal. 	—
Self check error. (Battery voltage)	<ul style="list-style-type: none"> • The connected battery pack’s voltage is more than 8.8 V. 	<ul style="list-style-type: none"> • Verify the battery voltage is correct. 	—
Self check error. (Water intrusion)	<ul style="list-style-type: none"> • Water has entered the transceiver. 	<ul style="list-style-type: none"> • Have the transceiver checked at your local distributor or dealer to see whether the transceiver works properly or not. 	—

VHF MARINE CHANNEL LIST 12

Channel number			Frequency (MHz)	
USA	INT	CAN	Transmit	Receive
	01	01	156.050	160.650
01A			156.050	156.050
	02	02	156.100	160.700
	03	03	156.150	160.750
03A			156.150	156.150
	04		156.200	160.800
		04A	156.200	156.200
	05		156.250	160.850
05A		05A	156.250	156.250
06	06	06	156.300	156.300
	07		156.350	160.950
07A		07A	156.350	156.350
08	08	08	156.400	156.400
09	09	09	156.450	156.450
10	10	10	156.500	156.500
11	11	11	156.550	156.550
12	12	12	156.600	156.600
13*	13	13*	156.650	156.650
14	14	14	156.700	156.700
15*	15*	15*	156.750	156.750
16	16	16	156.800	156.800
17*	17	17*	156.850	156.850
	18		156.900	161.500
18A		18A	156.900	156.900
	19		156.950	161.550

Channel number			Frequency (MHz)	
USA	INT	CAN	Transmit	Receive
19A		19A	156.950	156.950
20	20	20*	157.000	161.600
20A			157.000	157.000
	21	21	157.050	161.650
21A		21A	157.050	157.050
	22		157.100	161.700
22A		22A	157.100	157.100
	23	23	157.150	161.750
23A			157.150	157.150
24	24	24	157.200	161.800
25	25	25	157.250	161.850
26	26	26	157.300	161.900
27	27	27	157.350	161.950
28	28	28	157.400	162.000
	60	60	156.025	160.625
	61		156.075	160.675
61A		61A	156.075	156.075
	62		156.125	160.725
		62A	156.125	156.125
	63		156.175	160.775
63A			156.175	156.175
	64	64	156.225	160.825
64A		64A	156.225	156.225
	65		156.275	160.875
65A	65A	65A	156.275	156.275

Channel number			Frequency (MHz)	
USA	INT	CAN	Transmit	Receive
	66		156.325	160.925
66A	66A	66A*	156.325	156.325
67*	67	67	156.375	156.375
68	68	68	156.425	156.425
69	69	69	156.475	156.475
70	70	70	Rx only	156.525
71	71	71	156.575	156.575
72	72	72	156.625	156.625
73	73	73	156.675	156.675
74	74	74	156.725	156.725
77*	77	77*	156.875	156.875
	78		156.925	161.525
78A		78A	156.925	156.925
	79		156.975	161.575
79A		79A	156.975	156.975
	80		157.025	161.625
80A		80A	157.025	157.025
	81		157.075	161.675
81A		81A	157.075	157.075
	82		157.125	161.725
82A		82A	157.125	157.125
	83	83	157.175	161.775
83A		83A	157.175	157.175
84	84	84	157.225	161.825
84A			157.225	157.225

Channel number			Frequency (MHz)	
USA	INT	CAN	Transmit	Receive
85	85	85	157.275	161.875
85A			157.275	157.275
86	86	86	157.325	161.925
86A			157.325	157.325
87	87	87	157.375	161.975
87A			157.375	157.375
88	88	88	157.425	162.025
88A			157.425	157.425
		21b	Rx only	161.650
		25b	Rx only	161.850
		28b	Rx only	162.000
		83b	Rx only	161.775
WX channel	Frequency (MHz)			
	Transmit	Receive		
1	RX only	162.550		
2	RX only	162.400		
3	RX only	162.475		
4	RX only	162.425		
5	RX only	162.450		
6	RX only	162.500		
7	RX only	162.525		
8	RX only	161.650		
9	RX only	161.775		
10	RX only	163.275		

*Low power only.

NOTE: Simplex channels 3, 21, 23, 61, 64, 81, 82 and 83 **CANNOT** be lawfully used by the general public in USA waters.

13 SPECIFICATIONS

GENERAL

- Frequency coverage
 - Marine TX : 156.025–157.425 MHz
 - RX : 156.050–163.275 MHz
 - LMR TX/RX : 146.000–174.000 MHz
- Mode
 - Marine : 16K0G3E (Wide)
 - LMR : 16K0F3E (Wide)/8K50F3E (Narrow)
- Channel spacing : 25 kHz (Wide)
12.5 kHz (Narrow; LMR only)
- Current drain (at 7.2 V DC) : TX High (5 W) 1.6 A typical
Max. audio 200 mA typical
Power save 20 mA typical
- Frequency stability : ± 10.0 ppm (-30°C to $+60^{\circ}\text{C}$)
- Usable temperature range
 - Marine : -20°C to $+60^{\circ}\text{C}$; -4°F to $+140^{\circ}\text{F}$
 - LMR : -30°C to $+60^{\circ}\text{C}$; -22°F to $+140^{\circ}\text{F}$
- Dimensions : 62 (W) \times 97(H) \times 39(D) mm
(Projections not included) $2\frac{7}{16}$ (W) \times $3\frac{13}{16}$ (H) \times $1\frac{17}{32}$ (D) inch
- Weight (approx.; with BP-227) : 280 g (9.9 oz)

TRANSMITTER

- Output power (at 7.2 V DC) : 5 W (Hi), 3 W (Mid) and 1 W (Low)
- Modulation system : Variable reactance frequency modulation
- Max. frequency deviation : ± 5 kHz (Wide)
 ± 2.5 kHz (Narrow; LMR only)
- Audio harmonics distortion : Less than 10% (at 60% mod.)
- Spurious emissions : Less than -70 dBc typical

RECEIVER

- Receive system : Double-conversion superheterodyne
- Sensitivity (12 dB SINAD) : 0.25 μV typical
- Squelch sensitivity : Less than 0.35 μV (at threshold)
- Intermodulation rejection ratio : 70 dB typical
- Spurious response rejection ratio : 70 dB typical
- Adjacent channel selectivity : 70 dB typical (Wide)
60 dB typical (Narrow; LMR only)
- Hum and noise ratio : More than 40 dB (Wide)
More than 34 dB (Narrow; LMR only)
- Audio output power : 0.35 W typical at 10% distortion with an
8 Ω load

All stated specifications are subject to change without notice or obligation.

QUICK REFERENCE 14

Important operating instructions are summed up in this and the following page for your simple reference.
By cutting along the line and folding on the dotted line, it will become a card sized operating guide which can easily be carried in a card case or wallet, etc.

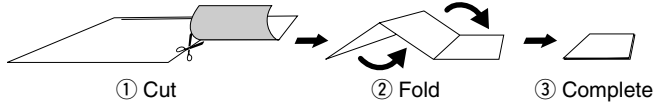

<CUT HERE>

• CHANNEL SELECTION (pgs. 8, 9)

•Channel 16

 Push



•Channel 9/Call channel

Push  for 1 sec.

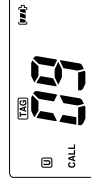

•Weather channel

 Push



•Call channel programming (p. 12)

- 1 Push [CH/WX*U/I/C] for 1 sec. once or several times, to select the desired channel group.
- 2 Push [16*9] for 1 sec. to select the call channel.
- 3 Push [16*9] for 3 sec. (until long beep changes to 2 short beeps)
- 4 Push [▲/▼] to select the desired channel.
- 5 Push [16*9] to program the displayed channel as the call channel.

•USA/International/Canadian/LAND channels

Push  for 1 sec.

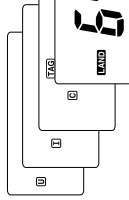

ICOM OPERATION GUIDE IC-M88

■ IN CASE OF EMERGENCY

- USING CHANNEL 16
- DISTRESS CALL PROCEDURE**

 1. MAYDAY MAYDAY MAYDAY.
 2. THIS IS (name of vessel)
 3. Your call sign or other indication of the vessel.
 4. LOCATED AT (your position)
 5. The nature of the distress and assistance required.
 6. Any other information which might facilitate the rescue.



■ SET MODE (pgs. 17—21)

- 1 While pushing [SQL], turn power ON. 
- 2 Push [SQL] again to select an item. Refer to pgs. 17—21 for set mode item.
- 3 Push [▲/▼] to select the desired condition.
- 4 Push [16-9] to return to regular operating mode.

■ DUAL/TRI-WATCH (p. 15)

- 1 Push [▲/▼] to select the desired channel.
- 2 Push [SCN•DUAL] for 1 sec. to start dualwatch or tri-watch depending on SET mode setting (p. 19).

■ LOCK FUNCTION (p. 12)

- Push  for 1 sec. to turn the lock function ON and OFF. 

■ TAG CHANNELS (p. 14)

- 1 Push [▲/▼] to select the desired channel.
- 2 Push both [▲] and [▼] for 1 sec. to set the displayed channel as a tag channel.

■ SCAN (p. 14)

- Push [SCN•DUAL] to start/stop scanning.

■ WEATHER ALERT (p. 9)

(Available for USA version only)

- 1 Turn the weather alert item in the SET mode ON (p. 18).
- 2 Select WX channel; or start scanning.

■ VOICE SCRAMBLER (p. 11)

(Available for the I/S version only)

- 1 Set a scrambler code in SET mode  (p. 21).
Cannot be used on ch 16, 70 or weather channels.
- 2 While pushing and holding [SQL], push [SCN•DUAL] to turn the function ON and OFF.

- **BP-226** BATTERY CASE
Battery case for 5 × AA (R6) alkaline cells.
- **BP-227** Li-Ion BATTERY PACK
7.2 V/1700 mAh Li-Ion battery pack. The same as supplied with the transceiver. BP-227 must be charged with the supplied BC-152 or the optional BC-119N/121N.
- **BC-119N** DESKTOP CHARGER + **AD-100** CHARGER ADAPTER + **BC-145** AC ADAPTER
For rapid charging of battery packs. An AC adapter is supplied with the charger. Charging time: approx. 2 to 2.5 hours
- **BC-121N** MULTI-CHARGER + **AD-100** CHARGER ADAPTER (6 pcs.) + **BC-124** AC ADAPTER
For rapid charging of up to 6 battery packs (six AD-100's are required) simultaneously. An AC adapter may be supplied depending on version. Charging time: approx. 2 to 2.5 hours.
- **BC-152** DESKTOP CHARGER + **BC-147A/E** AC ADAPTER
Used for regular charging of battery pack. The same as supplied with the transceiver. Charging time: approx. 9–10 hours
- **MB-86** SWIVEL BELT CLIP
Swivel type belt clip. The same as supplied with the transceiver.
- **HM-138** SPEAKER-MICROPHONE
Full-sized waterproof (JIS grade 7; 1m/30 min.) speaker-microphone including alligator type clip to attach to your shirt or collar, etc.

Count on us!

A-6214H-1EX-②
Printed in Japan
© 2002 Icom Inc.

Icom Inc.
1-1-32 Kamiminami, Hirano-ku, Osaka 547-0002 Japan