OWNER'S MANUAL

Azimuth 1000 Digital Compass

Installation
Testing
Auto-Compensation
Mounting at an Angle
Features
Special Functions
Technical Specifications
Troubleshooting
Wiring Data
NMEA 0183 Interface
Compass Notes
Warranty Plan

Congratulations!

You have purchased one of the most advanced compasses available today. The Azimuth 1000 digital compass is a microprocessor controlled system designed to provide you with accurate heading information in an easy to read manner. Both the fluxgate sensor and the LCD display are enclosed within one watertight, self-contained unit. The unique toroidal fluxgate sensor gives you accuracy far superior to that of a conventional card compass while eliminating the problems of spin, swirl, overshoot, sluggishness and instability which make conventional card compasses difficult to read on powerboats.

Should you have any questions, comments or suggestions please direct them to

Azimuth 1000.

KVH Industries, Inc.

50 Enterprise Center

Middletown, Rhode Island 02842 U.S.A.

tel.: (401) 847-3327

fax: (401) 849-0045

internet: <http://www.kvh.com>

Contents

I.	INSTALLATION INSTRUCTIONS	
1.	Parts List and Tool Requirements	6
2.	Choosing a Location	7
3.	Mounting the Azimuth 1000	9
4.	Checking Cable Lengths	12
5.	Making the Connections	12
6.	Testing	14
7.	Auto-Compensation	15
	Accessing Compensation Display	18
	Alignment Error Adjustment	22
	Disabling/Enabling Auto-Compensation	25
II.	MOUNTING THE AZIMUTH 1000 AT AN ANGLE	
1.	Determining the Offset Angle	27
2.	Adjusting the Offset Angle	30
III	USING THE AZIMUTH 1000	
1.	Features	33
2.	Compass Mode	34
3.	Off-Course Mode	34
4.	Damping Mode	36
IV.	SPECIAL FUNCTIONS	
1.	Warning Messages	39
	"Er1" Message	39
	"Lo" and "bAt" Message	39
V.	APPENDIX	
1.	Technical Specifications	40
2.	Troubleshooting Guide	41
3.	Wiring Data	47
4.	NMEA 0183 Interface	48
5.	Compass Notes	49
6.	Warranty & Protection Plan	52

Before you begin...

Important!

Before you jump into your installation:

1. Please read this manual thoroughly. The correct installation of the Azimuth 1000 is of utmost importance to its accuracy and precision, and most of all, to your enjoyment of your new electronic compass.

Serious damage, inaccuracies, or loss of warranty can result from incorrect installation.

2. Please send your warranty card back to ensure validation of your warranty. **Product warranties will only be honored if KVH has a completed warranty card on file.**

I. INSTALLATION INSTRUCTIONS

1. Parts and Tools

The Azimuth 1000 consists of one flush-mounted component. Parts enclosed are:

- sensor/display unit w/ 10' cable
- 3 #8 self-tapping mounting screws
- weather cover
- template for alignment offset

The only tools required are:

- Drill
- 9/64" and 3/4" drill bits
- Pencil
- Phillips Screwdriver
- Center Punch
- Tape
- Scissors or Xacto knife

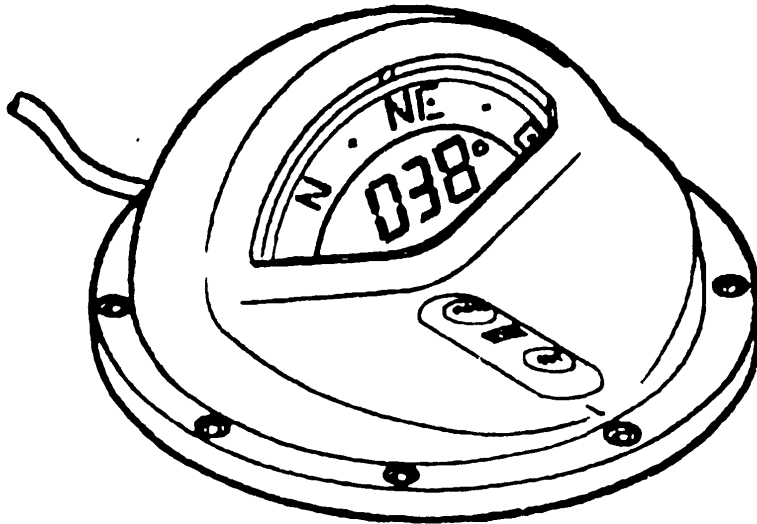

Following are step-by-step instructions for correct installation. Make sure that whoever is going to install your Azimuth 1000 is familiar with these installation instructions and under-

stands the principles of installation that ensure that your system has the precision, convenience and usefulness for which it is designed.

2. Choosing a Location

A good location for the Azimuth 1000 compass is anywhere visible to the helmsman steering the boat. This includes any place where you would find a conventional card compass or any place where you need compass information.

The ideal location also includes:

1. a location where the Azimuth can be mounted as close to level as possible
2. a location with as little magnetic interference as possible. Try to keep it away from:
 - magnets (in speakers, microphones)
 - ferrous metals (gears, keys, flashlights, tools)
 - card compasses
 - motors
 - wiring
 - electronics

Each compass is calibrated at the factory, so the more carefully you place the Azimuth 1000, the less compensation will be needed. If your old card compass worked properly in its loca-

tion, then the Azimuth 1000 will work better in that same location. The Azimuth 1000 is less susceptible to interference from nearby metal than a conventional compass. Heading deviation (less than 30° on any 1 heading) caused by nearby metal will be compensated out during the Azimuth's **automatic compensation procedure**. If your boat has severe magnetic interference problems, it would be prudent to connect the Azimuth 1000 to power before installing it. If the display flashes "Er1" in the desired location, then there is so much magnetic interference at that location that it cannot be compensated out. The Azimuth 1000 must be moved to the next best location where you do not get the "Er1" message. (*see "Er1", pg 39*)

Important Note: Do not mount the Azimuth 1000 within approximately 3 feet of a card compass. The magnet in the card compass will affect the accuracy of the Azimuth 1000 because the magnets in the card compass move in relation to the Azimuth's sensor as the heading changes, making the card compass a changing magnetic field. The Azimuth 1000 cannot compensate for changing magnetic fields. The distance necessary between the two compasses varies depending on the magnetic strength of the card compass.

An easy way to determine this distance is to power the Azimuth 1000 and bring it towards

the card compass keeping the Azimuth 1000 steadily pointing in the same direction. You will notice an obvious error caused by interference from the card compass when you get too close to it. Move the Azimuth 1000 back until you do not get this error. Do not move the Azimuth 1000 any closer to the card compass than this. This method will work to test for any type of interference.

3. Mounting the Azimuth

Mounting the Azimuth 1000 is critical to the performance of the system on your boat. The Azimuth 1000 is gimballed for heeling angles up to 25°, therefore it is important that it is mounted to within a few degrees of level.

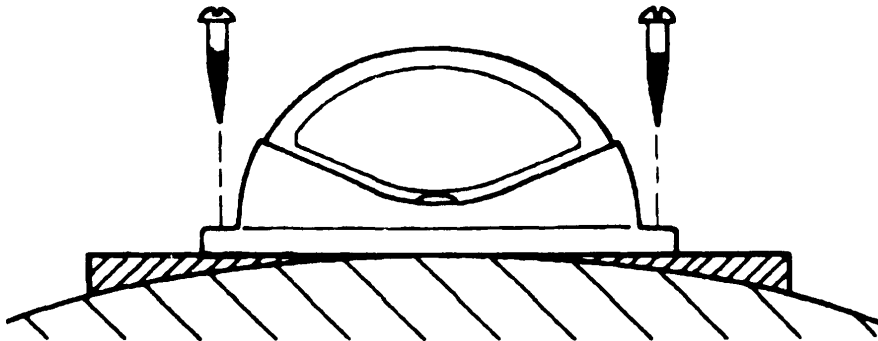

The Azimuth 1000 is a flushmount system. It can replace a conventional compass by being located over the hole where the conventional compass was located or positioned on the dash. A wedge or a block can be used to mount the compass and/or to level the unit if needed.

After finding the most visible and convenient location for the Azimuth 1000 on your boat, there are two mounting options. These are:

- A **Parallel** to the fore/aft centerline of the boat (*see illustration 10a*) , or
- B **At an angle** (up to $\pm 90^\circ$) to the fore/aft centerline of the boat. (*illustration 10b*)
Note: Familiarize yourself with the sections, "*Determining the Offset Angle*" and "*Adjusting the Offset Angle*", pages 27-32 then return to this section and proceed with your installation.

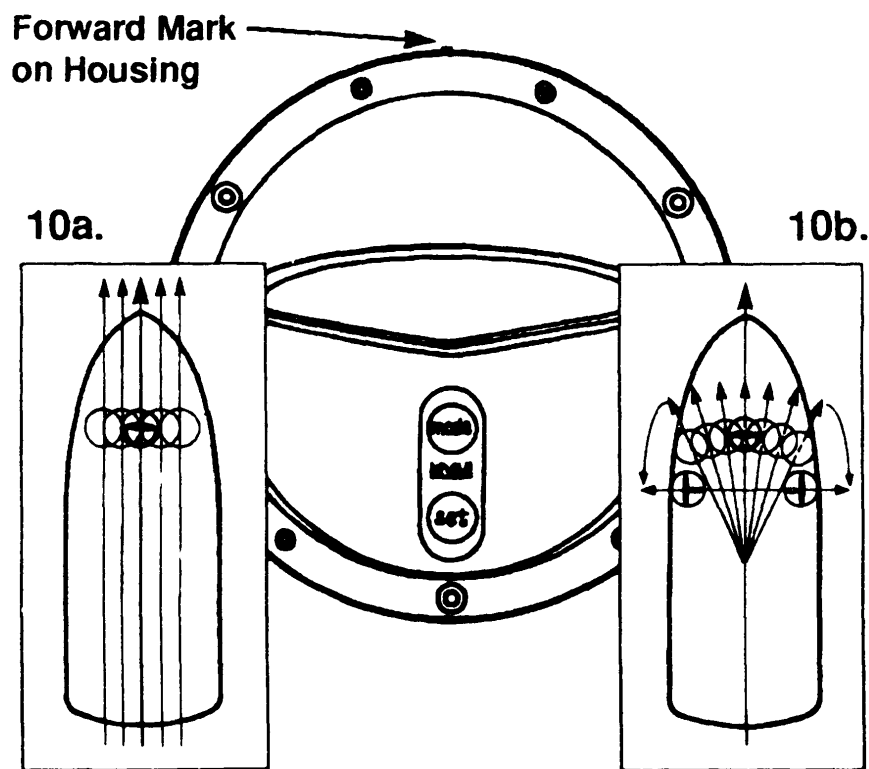

The mounting position you choose determines what type of adjustments you will be making to your Azimuth 1000. These adjustments are critical to the Azimuth 1000's performance, so make sure that you go through each step for the mounting option you have chosen.

After determining the correct spot for your Azimuth 1000, proceed as follows:

1. Place the provided template in the spot where you are going to mount the Azimuth 1000 and use a center punch to mark the center point of the hole for the power cable. **Remove the template.**
2. Drill a 3/4" hole for the power cable to exit below the unit.
3. Specific directions follow for the mounting option you have chosen:
 - A. **Azimuth 1000 mounted parallel:**
Feed the power cable below the unit and place the Azimuth 1000 in position, aligning the forward mark on the housing parallel to the fore/aft centerline of the boat. Using a pencil, mark the position of the 3 mounting holes, then drill 9/64" holes at each location. Position the Azimuth over the holes, place the #8 screws into the 3 mounting holes and tighten the Azimuth 1000 down to

your boat. **Do not overtighten!** Go to "4. Checking Cable Lengths", below.

- B** **Azimuth 1000 mounted at an angle:**
Turn to "Determining the Offset Angle", page 27.

4. Checking Cable Lengths

At this stage you can determine if the provided cable is sufficient for your needs. If it is not, you may extend any of the cable's wires using insulated 24 gauge (preferably shielded) wire.

5. Making the Connections

Now that you have the Azimuth 1000 in place, you are ready to connect it to power and do the final procedures to ensure its accuracy on your boat. The Azimuth 1000 power cable has 5 colored wires. Each wire has the following function:

red	switched +12V DC*
black	ship's ground
white	light

NMEA lines are only used for interfacing**:

green	NMEA 0183 Out(+)
brown	NMEA 0183 Out(-)

orange	not used (clipped back)
blue	not used (clipped back)
shield	not used (clipped back)

*Use only a +12V DC power source.

**Insulate any wires that are not used.

1. Connect the **red wire** to a +12V DC power source which is switched and fused (1 amp) or a current breaker (1 amp). There is no internal fuse in the Azimuth 1000 to protect it from current overloading.
2. Connect the **black wire** to ship's ground.
3. Connect the **white wire** to one of the following on your boat:
 - existing panel switch for instrumentation lighting
 - compass light switch

If you **do not** have a light switch on your boat, you may use a 2 position toggle switch to make one:

Connect the **white wire** of the Azimuth 1000 to one side of this switch. Connect the other side of the switch to your fused +12V DC power source.

4. The **green and brown wires** in the power cable are for outputting heading data from your Azimuth 1000 to your other instruments with NMEA 0183 data format. If these wires are not used they should be tied back separately and wrapped with electrical tape.

If you have mounted your Azimuth 1000 at

an angle, turn to "Adjusting the Offset Angle" page 30.

6. Testing

Testing lets you try out the various functions of the Azimuth 1000 to make sure everything is working correctly. Furthermore, all compasses must be checked for accuracy once installed on a boat. The Azimuth 1000 has an automatic compensation feature which must be performed after installation to ensure that any errors caused by your boat's magnetic field are compensated out. (*Auto-Compensation, page 15*)

To test the unit:

1. Turn the power **ON**.
Every time you turn the unit on, the display goes through a segment test where all of the segments are lit for 3-4 seconds (*see illustration*)

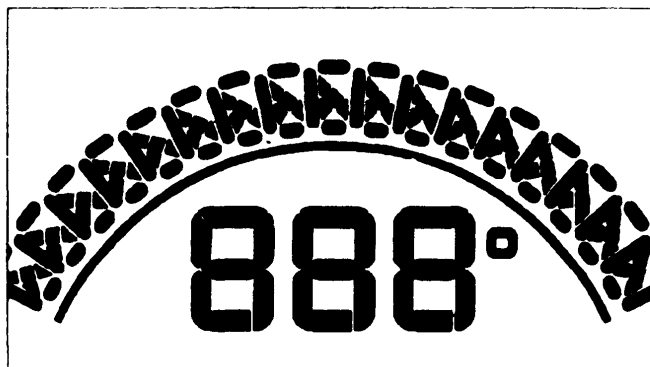

Do not push any buttons during this

segment test. If a button is pushed, an unfamiliar display may appear. If so, turn the power off and on again.

2. Check that the Azimuth's digital heading readout agrees approximately with a known heading or your boat's recently compensated card compass. If it is not, check to make sure that the Azimuth 1000 is installed correctly. If the Azimuth's heading is off and it is installed correctly, this indicates that you have some type of magnetic interference on your boat that must be compensated out of the Azimuth 1000.

You are now ready to compensate your Azimuth 1000.

7. Auto-Compensation

ALL COMPASSES, MUST BE CAREFULLY CHECKED AGAINST KNOWN REFERENCES AND/OR BE COMPENSATED BEFORE BEING USED FOR NAVIGATION.

The Azimuth 1000's "auto-compensation" capability automatically measures the surrounding magnetic field distortion and compensates it out, thereby removing the resulting heading errors and giving you a system with better than $\pm 1^\circ$ accuracy in most cases.

Although each Azimuth 1000 is carefully calibrated at the factory during manufacture, you should intentionally auto-compensate it on your boat after installation so that any errors due to metal and magnetism in your boat are removed.

The Azimuth 1000 is shipped from the factory with auto-compensation enabled. Every time the vessel completes a 360° turn within the time constraints of the system, the sensor will check its accuracy and re-compensate itself if required. Both "hard" (magnetic) and "soft" (iron) errors are automatically compensated by this procedure producing excellent accuracies ($\pm 1^\circ$). The Azimuth 1000 may re-compensate itself during normal boat use anytime the boat completes a 360° turn within the time constraints *and* the data resulting is 25% better than the previously stored data.

Important - Read before compensating for the first time!

Intentionally compensating the Azimuth 1000 at installation is very important to ensuring its accuracy on your boat and is very easy to do. It involves turning your boat through two large, lazy circles at a slow, steady speed (the circles may be slightly out of round or elliptical if necessary). During this procedure, it is critical that the boat remains level and slow enough (idle speed) so that a full circle takes at least 2 min-

utes to complete. You cannot go too slowly, but if you go too quickly at any point while doing the circles, the sensor is programmed to ignore the data to ensure a perfect compensation.

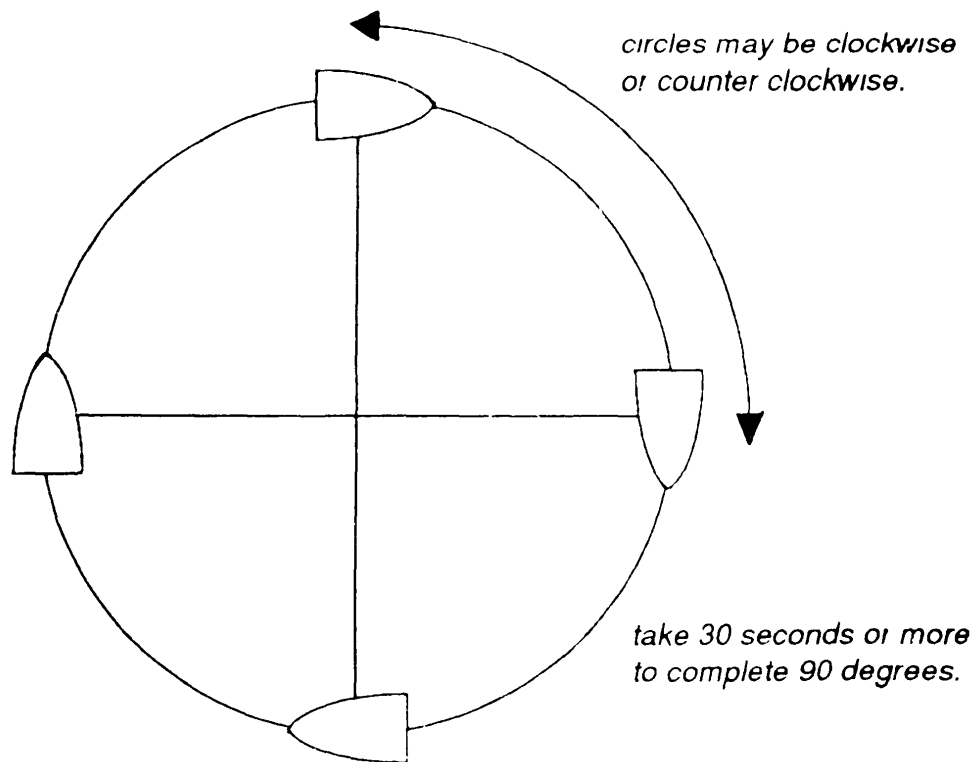

To compensate the Azimuth 1000:

1. Select a calm day and a clear area. Watch out for excessive pitching and rolling, as this can make your boat turn in surges faster than the Azimuth 1000 will accept.
2. Turn **ON** the Azimuth 1000 and note the heading so that you will roughly know when you have completed a full

circle.

3. There is no Compensation Mode or buttons to push - just steer your boat at a slow, steady speed (idle speed) through a full circle that takes at least 2 minutes to complete. (Try to time your turn so that it takes 30 seconds or more to turn 90 degrees.)
After completing one full circle, continue circling another time. Try slowing down even more and concentrate on keeping the boat steady and smooth throughout the 360°. Remember, the circles do not need to be perfectly round as long as you go a complete 360 degrees around.
4. Once you have completed two full circles, your compass should be compensated. Check to make sure by accessing the "**Compensation Display**" to review your auto-compensation and to check that everything is O.K. (*see below*)

Accessing the "Compensation Display" for Reviewing Compensation Data on the Azimuth 1000 Display-

The Azimuth 1000 has a "Compensation Display" which allows you to critically examine the quality of a compensation, the quality of the Azimuth's location, how many auto-compensa-

tions have occurred, as well as access other features described further on in this manual (*Alignment Error Adjustment and Disabling/Enabling Auto-Compensation, pages 22-26*).

To enter into the "Compensation Display" to see compensation data on the display:

1. Turn the power **ON** and wait until the display has gone through self-test.
2. Simultaneously push and hold down the **mode** and **set** buttons until the display reads "CAL" indicating that you are in the Compensation Display.*

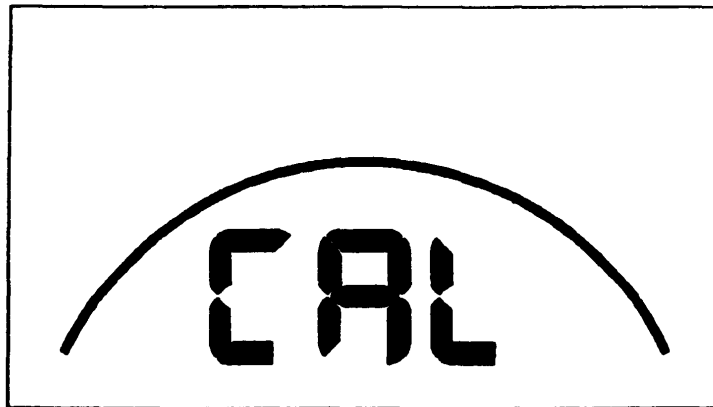

Once "CAL" is displayed, you may release the buttons. The display will now continuously roll through the following: "CAL" "on", and "###".

"on" indicates that auto-compensation is enabled. ("oFF" indicates auto-compensation is disabled.)

**If desired, you may have the "Compensation Display" ON when doing compensation circles, so you can see when the compass has auto-compensated.*

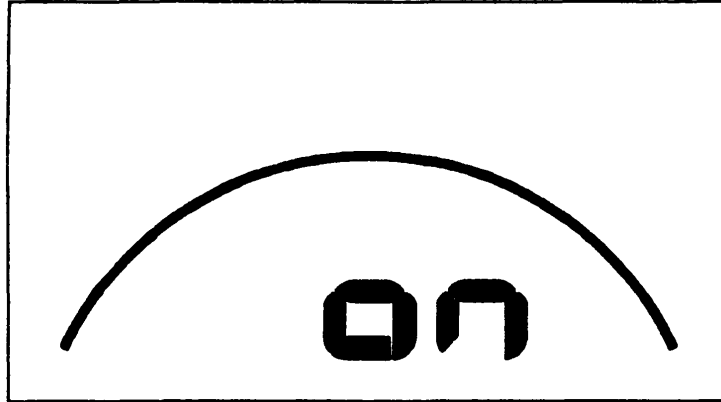

"###" (three digits) display auto-compensation data (a "000" indicates that the system has not been auto-compensated.)

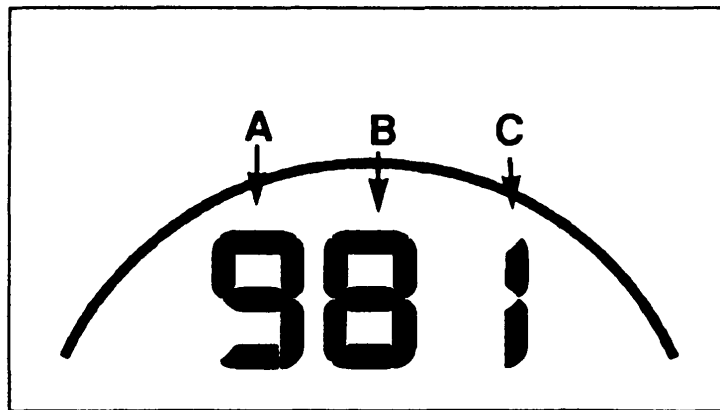

- A.** The first digit indicates the quality of the compensation (1-9) with "9" being the best.
- B.** The second digit indicates the quality of the sensor's magnetic location (1-9) with "9" being the best.
- C.** The third digit is a rollover counter incrementing 1 digit each time the

Azimuth has accepted a new compensation*.

For instance, a "981" indicates that you had a great compensation (9), a great magnetic location (8)** and this is your first compensation (1).

If the first digit is a "7" or lower, you should turn another 360° to try and get a better compensation. If the second digit is lower than a "3", you might consider moving the Azimuth 1000 to a better magnetic location. However, even with a "3" or lower, as long as the first digit is a "9" you should have $\pm 1^\circ$ accuracy.

If you ever significantly change your boat's latitude or make changes on your boat (install new equipment, run new cables, etc.) which may affect the boat's magnetic field, or if you are ever in doubt as to the Azimuth 1000's accuracy, simply follow the auto-compensation procedure on pages 15-18 to be assured that it is accurate at all times.

To exit the "Compensation Display", apply one short push to the **mode button** and the display will return to Compass Mode.

*the last digit will roll over to "1" after 9 compensations.

** for most installations, an "8" is the best achievable score

Alignment Error Adjustment

Now, you should check to see how well you aligned the Azimuth 1000 parallel with the centerline of your boat. To check the Azimuth's alignment, take a couple of known runs from a chart* and compare the magnetic bearing on the chart with the heading readout on the Azimuth display. (*If your Azimuth 1000 is mounted at an angle and you have adjusted the offset angle, the compass should agree with the magnetic bearing on the chart.*)

If the Azimuth reading is off by the same amount of degrees in a couple of directions, then every reading around the compass will be off by exactly that amount. This indicates that the Azimuth 1000 is not pointing exactly forward with respect to the bow of your boat (*or if mounted at an angle, the offset angle entered is slightly off.*) Rather than turn the Azimuth 1000 slightly to adjust for this Alignment ("A") error, you can adjust it electronically.

1. Enter into the "Compensation Display" by simultaneously pressing and holding down the **mode** and **set buttons** until "CAL" appears.
2. Now simultaneously press and hold down the **mode** and **set buttons** again until the display shows "AoF", indicating that you have entered the "Alignment Offset" section of the software.

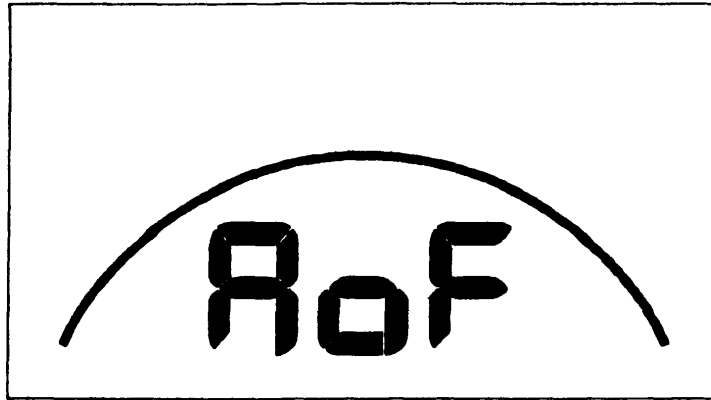

3. To examine the value for the "A" offset, apply a short push to either button. The display will flash the current value of the offset. Offset is set at the factory to 00°.

Important Note for Azimuth 1000's

mounted at an angle:

If you have mounted your Azimuth 1000 at an angle, you have already entered the "A" offset. **Now**, if you find that your Azimuth is consistently off in all directions, you need to adjust the offset to eliminate any inaccuracies due to compass position. Add the Offset Angle entered, to the "A" Offset and enter the sum. For instance, if you offset your Azimuth -35°(+35° adjustment) and now have determined that your headings are 2° high (-2° "A" Offset), the equation is: $(35^\circ) + (-2^\circ) = (33^\circ)$

You will enter (33°) into the memory.

4. If the heading is "low" (or to the minus(-) side on all headings), you need to add

offset. To increase the "A" Offset, hold the **mode button** down until the desired plus(+) value is displayed.

5. If the heading is "high" (or to the plus (+) side on all headings), you need to subtract offset. To decrease the "A" offset, hold the **set button** down until the desired minus(-) value is displayed.
6. To change the offset, use the **mode** and **set buttons** to scroll up or down the correct number of degrees.
7. To save the "A" offset and return to compass mode, simultaneously press and hold down the **mode** and **set buttons**. The new "A" Offset will be stored in memory and the display will return to compass mode. You will notice that the Azimuth's headings will now match the known headings.

Example: After auto-compensation, a comparison of a couple of Azimuth 1000 headings with "runs" from a chart indicate that the Azimuth is reading 2° lower than it should be. For instance, instead of displaying 180° it is displaying 178°. This means that the Azimuth 1000 is pointing to the left of the boat's centerline by 2°. To correct this, enter into the "Compensation Display" by simultaneously pushing the **mode**, and **set buttons** until "**CAL**"

appears. Now enter the "Alignment Offset" section of the software by simultaneously pushing the **mode** and **set buttons** again until 'AoF' appears. Apply a short push to either button to examine the value entered for "A" Offset (from the factory, this will be "00"). You need to add 2° to all headings to adjust for the "A" error, so push and hold down the **mode button** until "02" appears on the display and then release the button. Exit by simultaneously pushing the **mode** and **set buttons** again. Now, when you point to your reference of 180°, the Azimuth will display 180°.

Once the Alignment Error is adjusted, it is stored in memory and never has to be re-adjusted unless the Azimuth 1000 is moved.

Disabling/Enabling Auto-Compensation

With auto-compensation disabled, your Azimuth 1000 will be using the last compensation that has been stored, but will be unable to update itself if something changes in the boat's magnetic environment, etc. In essence, it is locked.

If you want to disable or enable auto-compensation, enter into the "Compensation Display" by **simultaneously** pressing the **mode** and **set buttons**. "CAL" and then "on" appears followed by 3 digits (###). Each time you press

and release the **set button** the display will display "oFF" or "on" and activate whatever is displayed. Once you release the button you will see that the display rolls through "CAL" "on" or "oFF" and "###" depending on which was activated with the last push and release of the **set button**.

Auto-compensation may be turned on/off in the Azimuth 1000 whenever desired. Just be aware of what state it is in. You may check this at any time by entering into the "Compensation Display" and watching whether "on" or "oFF" is displayed.

To **exit** the "Compensation Display", apply one short push to the **mode button**. Whatever was flashing on the display "on" or "oFF" will be activated and the display will return to compass mode.

Turn to "Using your Azimuth 1000" page 33.

II. MOUNTING THE AZIMUTH 1000 AT AN ANGLE

1. Determining the Offset

A conventional magnetic compass has to be pointed exactly forward. The Azimuth 1000 can be mounted off to the side and at an angle to the boat's central axis and adjusted electronically. If you want to do this, you must make an "offset" adjustment to realign it to your boat.

The Azimuth 1000 can be positioned at an angle up to 90° to the left or to the right of the boat's central axis. The angle you mount your compass off the boat's central axis is called the "Offset Angle". It is adjusted electronically.

Example: A boat's dash is positioned so that the best location for the Azimuth 1000 is to the left of the boat's steering wheel at approximately 25° off the central axis (turning axis) of the boat. Therefore, even if the compass needs no compensation, its heading would read $(-)$ 25° off in all directions. (see illustration) To adjust for this offset, you must electronically add 25° . You can adjust the "position" of

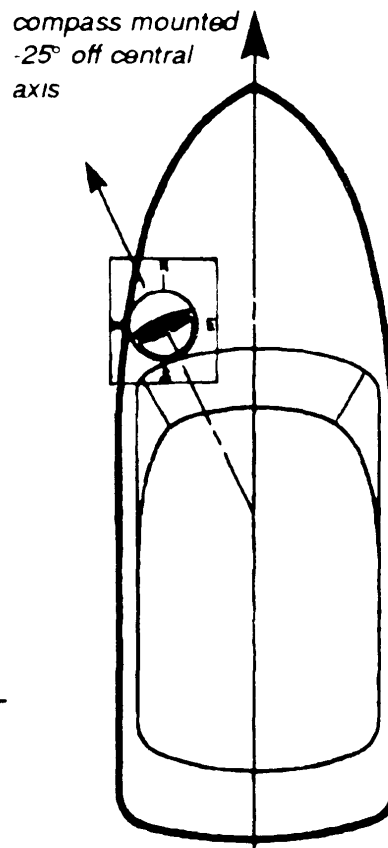

For Azimuth 1000's mounted at an angle only.

your Azimuth 1000 for practically any location.

You first need to determine the offset angle that your Azimuth 1000 will be mounted at. To determine this angle, do the following:

1. Place the Azimuth 1000 in position over the hole that you have drilled for the power cable.
2. Trace around the base of the Azimuth 1000 with a pencil and mark the location of the 3 mounting holes. Remove the Azimuth 1000.
3. On the supplied template, cut along the dotted line for the circle where the cable exits. Now align the template **on or parallel to the centerline of the boat** as well as with the Azimuth's traced outline on your boat. Tape template to your boat in this position. (see illustration on template)
4. Carefully place the Azimuth 1000 over the template in position over the marked mounting holes.
5. Mark on the template where the Azimuth 1000 is pointing by aligning the **forward mark on the Azimuth 1000 base** with the number of degrees on the template. (see illustration on next page)

For Azimuth 1000's mounted at an angle only.

This is the offset angle. Mark it well, as you will use this offset angle for aligning your Azimuth 1000 to your boat. Remove template.

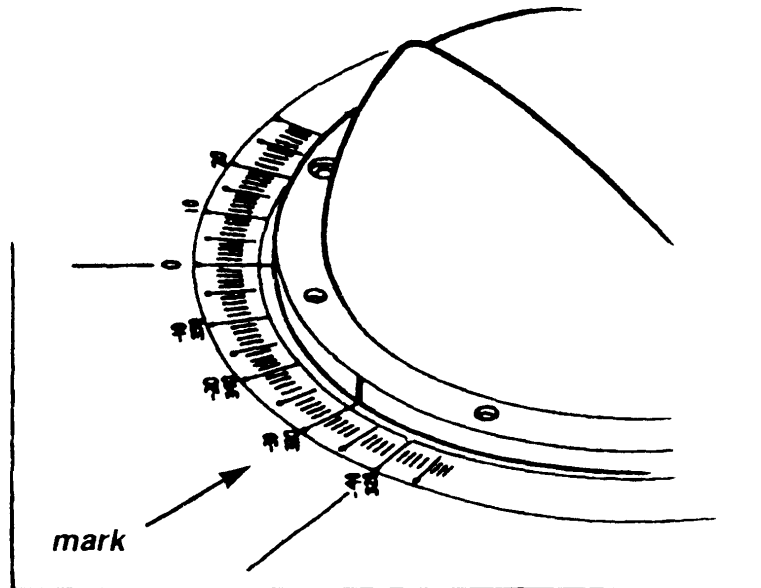

6. Drill $9/64$ " holes at each marked location. Position the Azimuth 1000 over the holes, place the #8 screws into the 3 mounting holes and tighten the Azimuth 1000 down to your boat. **Do not over tighten!**
7. Now go to "Checking Cable Lengths," page 12.

For Azimuth 1000's mounted at an angle only.

2. Adjusting the Offset Angle

Now that you have determined the offset angle and have made the connections, it is time to electronically align your Azimuth 1000 to your boat. To do this:

1. Turn the compass on and wait for the display to go through segment test.
2. Enter into the "Compensation Display" by simultaneously pushing the **mode** and **set** buttons until the display reads "CAL". Once "CAL" is displayed, release the button. The display will now continuously roll through the following: "on" , "###" (3 digits) and "CAL" (*for illustrations, see pages 19-20*).
3. Now enter into the "Alignment Offset" section of the software by again simultaneously pushing the **mode** and **set** buttons until the display reads "AoF".

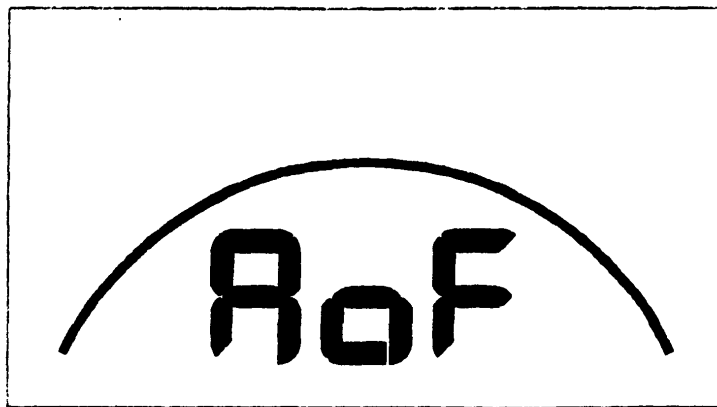

For Azimuth 1000's mounted at an angle only.

4. Determine how many +/- degrees your compass' position is off the central axis of the boat by using the Offset Angle that you marked on the template.
5. To align your compass, you must cancel out the Offset. ***For example***, you must **add** 25° to all headings for a (-)25° Offset Angle.
6. To examine the value for the "A" offset on the display, apply a short push to either button. The display will flash the current value of the offset. Offset is set at the factory to 00°.
7. The offset range is from -99° to +99°. However, the Azimuth 1000 should not be mounted at an angle more than ±90° off the central axis. The extra ±9° may be necessary for final fine tuning.
(Alignment Error Adjustment pg 22.)
8. If you have a negative (-) offset angle, you need to add offset. To increase the "A" offset, hold the **mode button** down until the desired plus (+) value is displayed.
9. If you have a positive (+) offset angle, you need to subtract offset. To decrease the "A" offset, hold the **set button** down until the desired minus(-)

For Azimuth 1000's mounted at an angle only.

value is displayed.

10. To change the offset, use the **mode** and **set buttons** to scroll up or down the correct number of degrees.
11. To review the offset before exiting the mode, apply a short push to either button. The current offset will flash on the display without changing its value. At this stage also check the "sign" ("+" / "-") of your offset and make sure it is correct for your offset. (if it is set "+" instead of "-" or vice versa, headings will be from 2° to 180° off!) You may notice that when changing between offset values, the display will sometimes hesitate. This is normal. The Azimuth 1000 is updating and needs time to catch up.
12. To save the entered "A" offset and return to compass mode, simultaneously press and hold down the **mode** and **set buttons** until compass information is displayed. The entered "A" offset will be stored in memory.

Once the Offset Angle is adjusted, it is stored in memory and never has to be re-adjusted unless the Azimuth 1000 is moved.

Now turn to "Testing", page 14.

III. USING THE AZIMUTH 1000

1. Features

The Azimuth 1000 is very straightforward in its operation. There are two buttons which control the various functions and features.

Mode Button: Subsequent pushes on the **mode button** scroll through the Azimuth 1000's three modes. These are:

- **Compass Mode**
- **Off Course Mode**
- **Damping Mode**

Each time the **mode button** is pushed and released it goes to the next mode. The **mode button** is a passive button; it does not change anything on the display within each mode, it merely puts you into the mode and allows you to review the settings for each mode.

Set Button: The **set button** enters or changes information each time it is pressed and released. It is an action button and its function depends on which mode the display is currently in. For instance, when the display is in **Compass Mode**, pushing the **set button** places the display into the **Off Course Mode** **and** sets the present course as the reference course, while in **Damping Mode**, pushing the **set button** changes the damping level.

2. Compass Mode

Compass Mode shows the current magnetic heading in large digits combined with an electronic compass rose with the cardinal compass points rotating in a semi-circle. There is nothing to set in this mode.

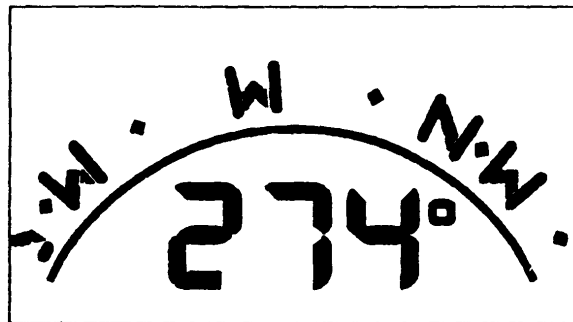

If the **set button** is pushed while in **Compass Mode**, the display will automatically go into **Off Course Mode**, using the heading displayed as the reference course for the off-course indicator and deleting the previous reference course.

3. Off Course Mode

Off Course Mode allows the user to enter a course to steer by pushing the **set button** when the desired heading is displayed. In **Off Course Mode**, the upper analog display becomes an Off Course indicator with segments filling to the left or right indicating how many degrees the boat is off the reference

course. New reference headings may be entered for the Off Course Indicator by pushing and releasing the **set button** when the desired digital heading appears on the display in either **Compass** or **Off Course Mode**. When the **set button** is pushed and released, two line segments will appear followed by a small diamond in the center of the upper analog display indicating that the digital heading displayed is the new reference course and the boat is presently on this reference course.

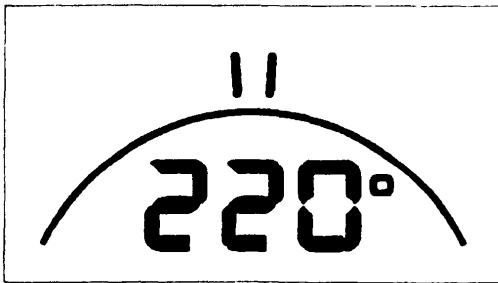

new reference course = 220°

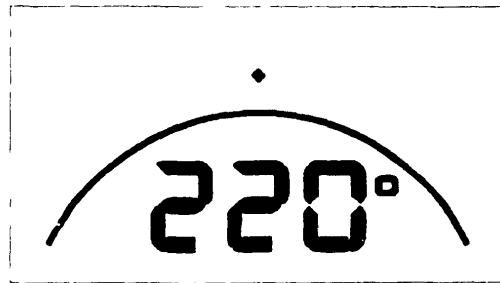

on course; course = 220°

If you steer off of this course, segments will fill to the left or to the right indicating that you are off the reference course. Each line segment is equivalent to 2° off course. Line segments with tails are equivalent to 5° off course.

each line segment w/tail = 5°

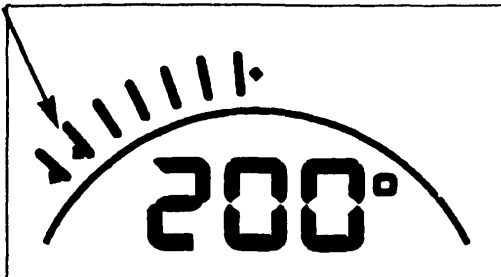

20° off course to port

each line segment = 2°

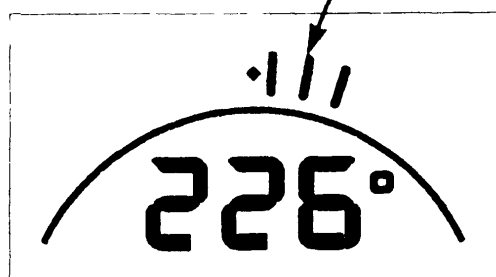

6° off course to starboard

The default course for the off-course indicator is 000°, so each time the system is turned on and you enter the **Off Course Mode** by pushing the **mode button**, the display will indicate you are off course from 000°. Pushing the **set button** now will enter the present heading as the new reference course.

You may enter **Off Course Mode** without changing the reference course by using the **mode button**. Entering the **Off Course Mode** through the **set button** will automatically enter the present heading as the new reference course and erase the previous reference course.

4. Damping Mode

The **Damping Mode** allows the user to easily change the damping level as conditions change. The **Damping Mode** controls the averaging period over which the compass displays information. Damping does not diminish the accuracy of the Azimuth 1000 like it does in a conventional compass. The damping levels range from 0-9, with 0 damping being a nearly instantaneous readout, and damping 9 about 20 seconds of averaging. On most boats, a damping level between "d-4" and "d-5" is the most stable and responsive. As you use your Azimuth 1000, you will quickly deter-

mine which level you prefer. If you are in rough seas, or if you are going at very high speeds, you will want to increase the damping so that you get a more stable display. In calm waters or at lower speeds, you may want to decrease the damping so that the display responds more quickly.

When in **Damping Mode**, the display will return to **Compass Mode** if the **set button** is not pushed within 10 seconds.

Changing the Damping Level

1. Push and release the **mode button** until you see "d-#" on the display. This indicates that you are in the **Damping Mode** (Damping is set at the factory to "d-2").

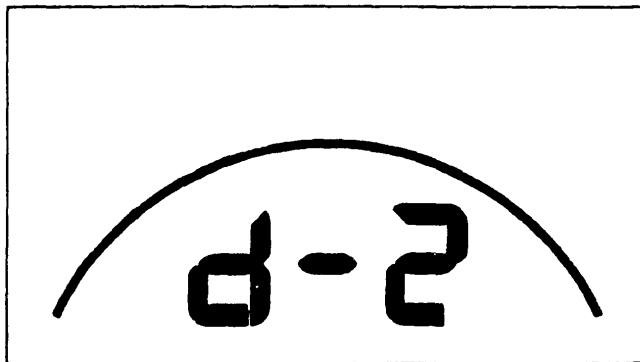

2. Push and hold down the **set button** and the Azimuth 1000 will begin scrolling through the various damping levels (0-9). When it reaches the desired damping level, release the button and the level appearing on the display will be locked into memory. The Azimuth 1000

stores the last damping level entered in memory, even after the unit is turned off. (Wait 5 seconds for the new value to be updated before turning off the system).

IV. SPECIAL FUNCTIONS

1. Warning Messages

"Er1" Message

If the Azimuth display flashes "Er1" alternately with normal compass information, this indicates that the system is "magnetically overloaded". If this message is displayed when installing your Azimuth 1000, the compass cannot perform auto-compensation and must be moved to a better location where you do not get this message. If this message suddenly appears long after you have installed and compensated your compass, it is an indication that something has dramatically changed in the compass' environment. Check the area around the Azimuth 1000. This message can be caused by a magnetic field or large amounts of metal located nearby. Speakers, tool boxes, anchors, and electric motors are items that could cause this message to appear.

"Lo" and "bAt" Message

If the display flashes between "Lo", "bAt", and the current heading, the unit has insufficient voltage to function reliably. All functions and auto-compensation will be inhibited until the Azimuth 1000 receives sufficient power/voltage to function. You should immediately remedy the situation when you see "Lo" "bAt" displayed.

V. APPENDIX

1. Technical Specifications

Performance

Accuracy	±0.5°
Gimbal Range	±25°
Oper. Temp. Range	0°C to 70°C
Storage Temp. Range	-20°C to 80°C
Humidity Range	0% - 100%
Field Strength Sensitivity	6.5 - 65μ Tesla
Range Horiz. Component	80° Mag. Incl. or dip
Damping Levels	Select Range 0-9

Interface Capability

Standard Output	NMEA 0183
-----------------	-----------

Power Supply

Voltage Requirements	12V DC
Current Consumption	75 mA light off 135 mA light on

Dimensions

Base (flange)	6-1/4" D (15.9 cm)
Height	2-3/4" H (7 cm)

Weight/Cable Length

Azimuth 1000 w/cable	12 oz. (340 g.)
Cable Length	10 ft. (3 m.)
Shipping Weight	2.5 lbs (1.1 kg)

2. Troubleshooting

Any problem you may have with the Azimuth 1000 can usually be quickly remedied by first checking for the following:

1. low battery voltage
2. incorrect installation
3. poor electrical connections

Backlight out Segments dim or missing from LCD

1. Check power supply as battery voltage may be incorrect or so low that even "Lo" "bAt" cannot be displayed.
2. Make sure power supply is 12V DC.
3. Check red (+12V DC), black (ground) and white (light) wire leads to 12 V DC power source for clean connections.
4. Call the KVH Sales Office.

Random segments appear
All segments come on at once
Heading freezes
No reading on display
Heading resets to 000°

1. Check power supply as battery voltage may be incorrect or so low that even "Lo" "bAt" cannot be displayed.
2. Make sure power supply is 12V DC.
3. Check red (+12V DC) and black (ground) wire leads to 12 V DC power source for clean connections.
3. There may be an electrical noise source too near display or sensor. Install an in-line noise filter.
Recommended: Radio Shack 270-051
4. Call the KVH Sales Office.

During an intentional auto-compensation:

A. "compensation display" shows a compensation has occurred before turning 360°;

A. Most likely, you were turning in a circle, before you "started", that is, before you noted the heading on the display and the Azimuth 1000 started gathering data before you realized it*. Continue turning in a slow, full circle. Most likely, the display will record another compensation (unless the compensation was not 25% better than the first one).

B. "compensation display" shows a compensation occurring approximately every 36° during a 360° turn;

B. On some boats, the particular magnetic field is so dramatically different from what the compass has stored from its factory calibration or from a previous compensation that the compass will take new information every 36° to quickly try and improve its accuracy. If this happens after you have initially compensated your compass, it is an indication that the environment has dramatically changed around your Azimuth 1000. For instance, someone may have placed a metal object near the Azimuth 1000. If you are not aware of any changes, you should check the Azimuth 1000's environment,

**with auto-compensation enabled, the sensor will re-compensate every time it gets better information, refining the accuracy each time.*

do an intentional auto-compensation (*see pgs. 15-18*) and examine the compensation data (*pgs. 18-21*).

C. "compensation display" shows multiple compensations have occurred after completing a full circle.

C. This is normal. Unit can re-compensate often and will if it receives better information.

After several attempts at an intentional Auto-Compensation, the "Compensation Display" does not show that an Auto-Compensation has occurred and the heading accuracy has not improved.

1. You are probably turning too fast. Make sure you are not traveling faster than 90° in 30 seconds. **GO SLOWLY!**
2. Conditions may be too rough. The boat's pitch and roll is affecting the ability for the compass to compensate. Try again on a calmer day or in a more sheltered location.
3. Check the "Compensation Display" to see if the Azimuth 1000 has accepted a compensation. (*see pgs. 18-21*) and

make sure Auto-Compensation is not disabled. (see pgs. 25-26).

4. Magnetic location may be unstable. Move the Azimuth 1000 away from changing magnetic fields. (see pgs 7-9)

Heading inaccurate

Heading jumps erratically or too slowly

Heading jumps randomly; unstable

1. Check power supply as battery voltage may be incorrect or so low that even "Lo" "bAt" cannot be displayed.
2. Make sure power supply is 12V DC.
3. Check red (+12V DC) and black (ground) wire leads to 12 V DC power source for good, clean connections.
4. Check the damping level to make sure it is set correctly for your boat size and/or boating conditions. (see pgs. 36-38)
5. Check installation of Azimuth 1000. It may be mounted near ferrous metal, other external magnetic influences or near a changing magnetic field (motor, windshield wipers, card compass, etc.)

(see Choosing a Location, pgs. 7-9)

If the environment looks unchanged, try doing auto-compensation circles ***(see pgs. 15-18)*** to see if the sensor takes a new compensation and settles down.

6. Compass may not be correctly electronically aligned to your boat. Check a known heading against the Azimuth 1000's heading readout. If the heading is incorrect, do auto-compensation circles ***(see pgs. 15-18)*** and then re-align the compass to your boat. ***(see Mounting the Azimuth 1000 at an Angle, pgs. 27-32)***
7. Call the KVH Sales Office.

3. Wiring Data

Power Cable Wiring

<u>Function</u>	<u>Color</u>
+12V	Red
Ground	Black
Light	White
NMEA 0183 Out (+)	Green
NMEA 0183 Out (-)	Brown
Not used	Orange
Not used	Blue
Not used	Shield

4. NMEA 0183 Interface

The NMEA interface transmits heading data organized into sentences defined as follows:

- Sentence length is 19 bytes.
- Update Rate = 10 Hz.
- Format parameters:
 - * Bytes are encoded as 7 bit ASCII characters in an 8 bit byte with the most significant bit set to zero.
 - * No Parity bit.
 - * One start bit & one stop bit.
 - * 4800 Baud
 - * The total number of bits per transmitted data byte is 10.

The sentence is:

`$HCHDM,abc.d,M*<checksumMS><checksumLS><cr><lf>` where *a* is the BCD hundreds digit of the heading, *b* is the tens digit, *c* is the ones digit, and *d* is the tenths digit. `<checksumMS>` is an ASCII character in the range 0-9 or A-F that represents the most significant nibble of the checksum. Similarly, `<checksumLS>` represents the least significant nibble of the checksum.

The checksum is calculated by XOR'ing together all the characters in the sentence up to, but not including the "*" character. [i.e. XOR together "H", "C", "H", "D", "M", ",(comma)", "hundreds digit", "tens digit", "ones digit", "decimal point", "tenths digit", ",(comma)", "M"]

5. Compass Notes

Initial Auto-Compensation Date _____

Offset Angle (if mounted at angle) _____

"A" Offset Set?" _____

6. Warranty & Protection Plan

LIMITED WARRANTY ON HARDWARE

KVH Industries, Inc. warrants the Azimuth 1000 purchased against defects in materials and workmanship for a period of ONE (1) year from the date of original retail purchase by the original purchaser. If you discover a defect, KVH will, at its option, repair, replace or refund the purchase price of the product at no charge to you, provided you return it during the warranty period, transportation charges prepaid, to the factory direct. Please attach your name, address, telephone number, a description of the problem and a copy of the bill of sale or sales receipt as proof of date of original retail purchase, to each product returned to warranty service

This Limited Warranty does not apply if the product has been damaged by accident, abuse, misuse or misapplication or has been modified without the written permission of KVH, if any KVH serial number has been removed or defaced or if any factory-sealed part of the system has been opened without authorization

THE EXPRESS WARRANTIES SET FORTH ABOVE ARE THE ONLY WARRANTIES GIVEN BY KVH WITH RESPECT TO ANY PRODUCT FURNISHED HEREUNDER; KVH MAKES NO OTHER WARRANTIES, EXPRESS, IMPLIED OR ARISING BY CUSTOM OR TRADE USAGE, AND SPECIFICALLY DISCLAIMS ANY WARRANTY OF MERCHANTABILITY OR OF FITNESS FOR A PARTICULAR PURPOSE. SAID EXPRESS WARRANTIES SHALL NOT BE ENLARGED OR OTHERWISE AFFECTED BY TECHNICAL OR OTHER ADVICE OR SERVICE PROVIDED BY KVH IN CONNECTION WITH ANY PRODUCT.

KVH's liability in contract, tort or otherwise arising out of or in connection with any product shall not exceed the price paid for the product. **IN NO EVENT SHALL KVH BE LIABLE FOR SPECIAL, PUNITIVE, INCIDENTAL, TORT OR CONSEQUENTIAL DAMAGES OR LOST PROFITS OR GOODWILL (INCLUDING ANY DAMAGES RESULTING FROM LOSS OF USE, DELAY IN DELIVERY OR OTHERWISE) ARISING OUT OF OR IN CONNECTION WITH THE PERFORMANCE OR USE OR POSSESSION OF ANY PRODUCT, OR ANY OTHER OBLIGATIONS RELATING TO THE PRODUCT, EVEN IF KVH HAS BEEN ADVISED OF THE POSSIBILITY OF SUCH DAMAGES.**

If any implied warranty, including implied warranties of merchantability and fitness for a particular purpose, cannot be excluded under applicable law, then such implied warranty shall be limited in duration to ONE (1) YEAR from the date of the original retail purchase of this product by the original purchaser

Some states do not allow the exclusion or limitation of implied warranties or liability for incidental or consequential damages, so the above limitations may not apply to you. This warranty gives you specific legal rights, and you may also have other rights which vary from state to state

BUYER PROTECTION PLAN

In addition to the foregoing warranty, KVH will provide to the original purchaser an additional TWO (2) years limited coverage under the "Buyer Protection Plan (BPP)" During these two years, KVH will repair or replace any defective component for a nominal fixed price, provided you return it during the BPP period, transportation charges prepaid, to the factory direct. Please attach your name, address, telephone number, a description of the problem and a copy of the bill of sale or sales receipt as proof of date of original retail purchase, to each product returned to warranty service

This BPP does not apply if the product has been damaged by accident, abuse, misuse or misapplication or has been modified without the written permission of KVH if any KVH serial number has been removed or defaced or if any factory-sealed part of the system has been opened without authorization



50 Enterprise Center
Middletown, Rhode Island 02842 U.S.A.
#54-0042 Rev. F

Mounting Template

Use for installing the Azimuth 1000
at an angle to the centerline of the boat

Align this line on or parallel
to boat's central axis.

