



## Trolling Charger Series OWNER'S MANUAL

### ON BOARD BATTERY CHARGERS

<u>Models</u>	<u>Amperage</u>	<u>No. Of Banks</u>	<u>Volts</u>
2613A	5,5,5 Amps	3 Bank	12/24/36
2620A	10,10 Amps	2 Banks	12/24
2623A	10,5,10 Amps	3 Banks	*12 or 24
2631A	10,10,10 Amps	3 Banks	12/24/36

\* : See Connection diagrams for warnings.

### IMPORTANT NOTICE

This manual contains important safety and operating instructions for the charger. Read the entire manual before using. Also read all instructions and cautions for and on the charger, batteries and equipment in the vicinity of the batteries.

### 1. INTRODUCING THE CHARGER

The Guest model 2613A, 2620A, 2623A and 2631A are designed to both recharge your batteries, and extend your battery's life in applications where it is stored for long periods of time. They are "3-stage" electronic, completely automatic, lightweight, silent, battery chargers and each output produces 12 Volts DC at either a full 5 Amps or 10 Amps (model specific), while using much less AC current than other charger types. Unlike automotive "trickle" chargers, the 2613A, 2620A, 2623A and 2631A will not boil off the electrolytes in properly installed and maintained batteries. When the charger is attached to your batteries and plugged into a standard 115 Volt / 60 Hz AC outlet, the red and green LED's, mounted on the face of the charger let you know the unit is *recharging* and *maintaining* your batteries. This sophisticated device is ideal for recharging and maintaining the 12VDC batteries in your boat, electric vehicle or cart, ATV, snowmobile or motorcycle.

**SAVE THESE INSTRUCTIONS**

## **WARNINGS**

**THIS CHARGER SHOULD BE USED TO CHARGE ONLY LEAD ACID OR GEL CELL TYPE BATTERIES. USE ON OTHER BATTERY TYPES MAY EXPLODE AND CAUSE PERSONAL INJURY.**

**RISK OF EXPLOSIVE GASES! WORKING IN THE VICINITY OF LEAD ACID BATTERIES IS DANGEROUS. BATTERIES GENERATE EXPLOSIVE GASES DURING NORMAL OPERATION. THEREFORE IT IS OF THE UTMOST IMPORTANCE THAT EACH TIME BEFORE USING YOUR CHARGER YOU FOLLOW THE INSTRUCTIONS EXACTLY.**

### **Personal Safety Precautions**

Adhere to the following personal safety precautions when installing or working with the chargers:

1. Someone should be within voice range or close enough to come to your aid when you work near a lead-acid battery.
2. Have plenty of fresh water and soap nearby in case battery acid contacts skin, clothing, or eyes.
3. Wear complete eye protection and clothing protection. Avoid touching eyes while working near a battery.
4. If battery acid contacts skin or clothing, wash them immediately with soap and water. If acid enters the eye, flood the eye with cold, running water for at least ten minutes and get medical attention.
5. Never smoke or allow an open flame in the vicinity of the battery.
6. Do not drop a metal tool onto the battery. It may spark, short circuit the battery and may cause an explosion.
7. Remove all personal metal items such as rings, bracelets, necklaces, and watches when working near a lead-acid battery. A battery can produce short circuit currents high enough to weld a ring or the like to metal, causing a severe burn.

### **Preparing to Charge Precautions**

Before charging a battery with the charger, read the following precautions:

1. Do **NOT** operate the charger if the cables or an LED is damaged.
2. Make sure all accessories on the product you are charging are **OFF**.
3. If the battery or batteries must be removed from the product, always remove the grounded terminal from the battery first.
4. Be sure the area around the battery is well ventilated while the battery is being charged. Gas can be forcefully blown away using a piece of cardboard or other non-metallic material as a "hand fan".
5. Clean battery terminals. Be careful to keep corrosion from coming in contact with eyes.

6. Add distilled water in each cell until battery acid reaches levels specified by the battery manufacturer, if applicable. Do not overfill. For a battery without cell caps, carefully follow the manufacturer's recharging instructions.
7. Never allow the ring terminals to touch each other.
8. **NEVER** charge a frozen battery.
9. Please be sure the DC system to which the charger is connected is not drawing excessive current from the battery for extended periods of time while the charger is operating. This is important to ensure the charger correctly transitions through each charging stage to finish with the float voltage level. If the DC system is drawing continuous current while charging, reduced life or damage to the battery may occur.

## AC Connection and Grounding Precautions

### **DANGER**

**DO NOT OPERATE THIS CHARGER WITH A TWO BLADED ADAPTER PLUG OR EXTENSION CORD. DOING SO CAN RESULT IN SERIOUS PERSONAL INJURY. AFTER SECURING THE BATTERY CONNECTIONS, PLUG THE AC LINE CORD INTO AN AVAILABLE AC OUTLET THAT IS PROTECTED BY A GROUND FAULT CIRCUIT INTERRUPTER (GFCI) BREAKER.**

**CAUTION:** To reduce the risk of shock, connect only to a properly grounded outlet.

**NOTE:** AC Line Cord color coding is EU style. Line = Brown, Neutral = Blue, Ground = Green

## 2. INSTALLING THE CHARGER

### Choosing Charging Location

The charger should have at least eight inches of unobstructed area on all sides of the unit for effective cooling. The case of this charger will become warm during operation. Because the charger is convection cooled (airflow over the back of the charger), the optimum mounting position for the charger is vertical. Mounting on its back on a horizontal surface may cause the charger to slightly reduce amperage output due to the thermal protection built in. Do not install the charger on carpeted, upholstered, or varnished surfaces.

### Mounting the Charger

1. Use corrosion resistant 1/4" dia. bolts, backed by a flat washer, and secured to the mounting surface with a split-ring lock washer.
2. Hold the charger to the mounting surface and mark the holes.
3. Remove the charger and drill the mounting holes.
4. Align the charger and assemble the mounting hardware. Secure.

## Making DC Connections

Check polarity of the battery posts. The POSITIVE (POS., P, +) battery post usually has a larger diameter than the NEGATIVE (NEG., N, -) post. Connect Red charger output wire to POSITIVE post, Black charger wire to NEGATIVE. See below diagrams for more details.

## Making AC Connections

Connect the AC plug into an AC receptacle, which is protected by a Ground Fault Circuit Interrupter (GFCI) breaker.

## Battery Size Recommendations

The recommended maximum battery size per 5 amp bank is 60AH.

The recommended maximum battery size per 10 amp bank is 120AH.

## 2613A Connections

Model	Output Volts	Output Amps	Banks	DC Cable Size	Size (inches) L x W x H	Input Volts	Input Amps Max
2613A	12/24/36	5/5/5	3	6'4'4'	9.6 x 7 x 2.6	115VAC 50/60Hz	3.5 Amp

**Diagram 1. 2613A (5/5/5 Amps) used with 3 independent 12V Batteries**

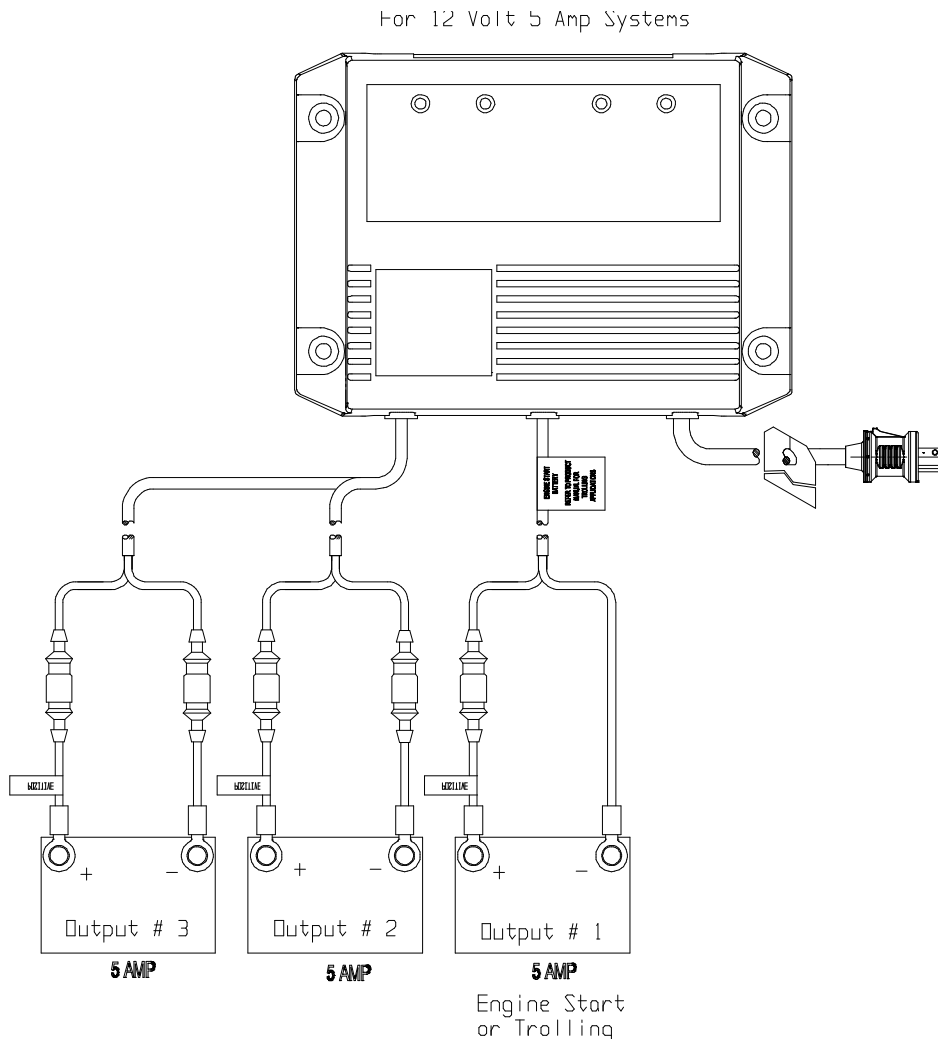

**2613A Connection Warnings:** For the 2613A, only output 2 and output 3 may be connected in parallel for a 12 V 10 amp output. The engine start output (Output 1) may not be connected in parallel with output 2 & 3.

## 2613A Connections

### Diagram 2. 2613A used in a 24V system

For 24 Volt 5 Amp and 12 Volt 5 Amp Systems.

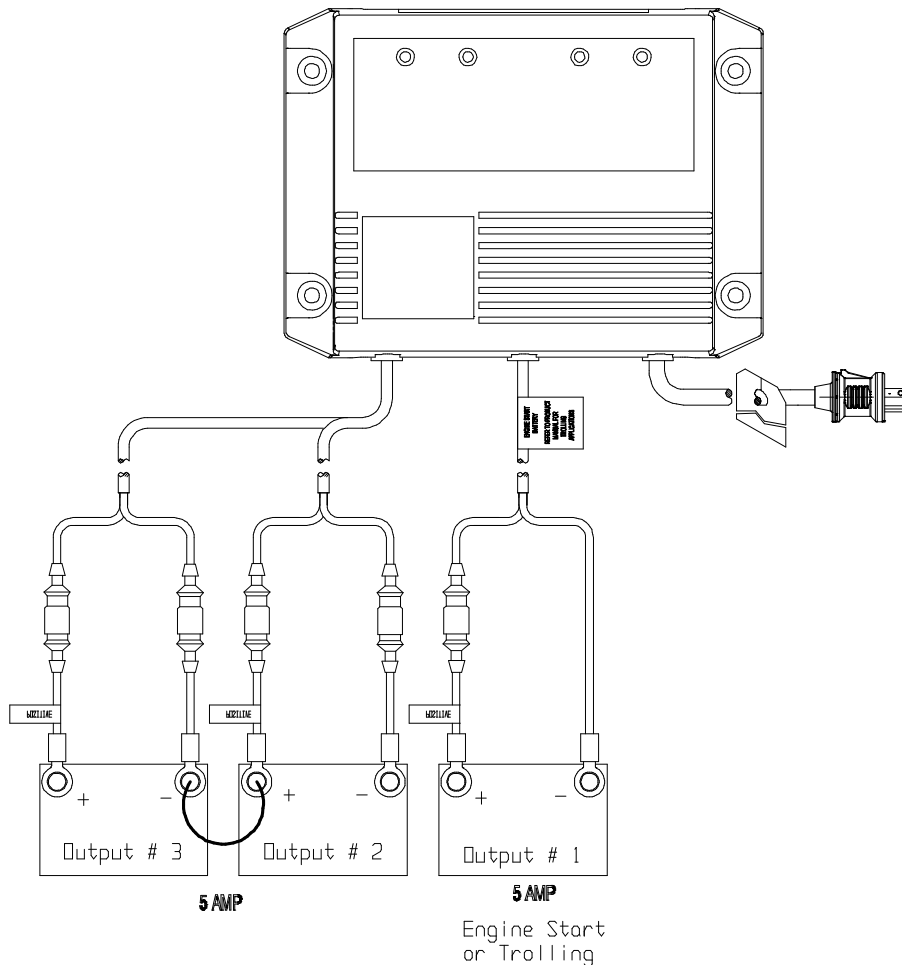

**To use a 2613A in a 36V system connect all 3 outputs in series.**

## 2620A Connections

Model	Output Volts	Output Amps	Banks	DC Cable Size	Size (inches) L x W x H	Input Volts	Input Amps Max
2620A	12/24	10/10	2	6'6"	9.6 x 7 x 2.6	115VAC 50/60Hz	5 Amps

**Diagram 3. 2620A (10/10 Amps) used with 2 independent 12V Batteries**

For 12 Volt 10 Amp Systems

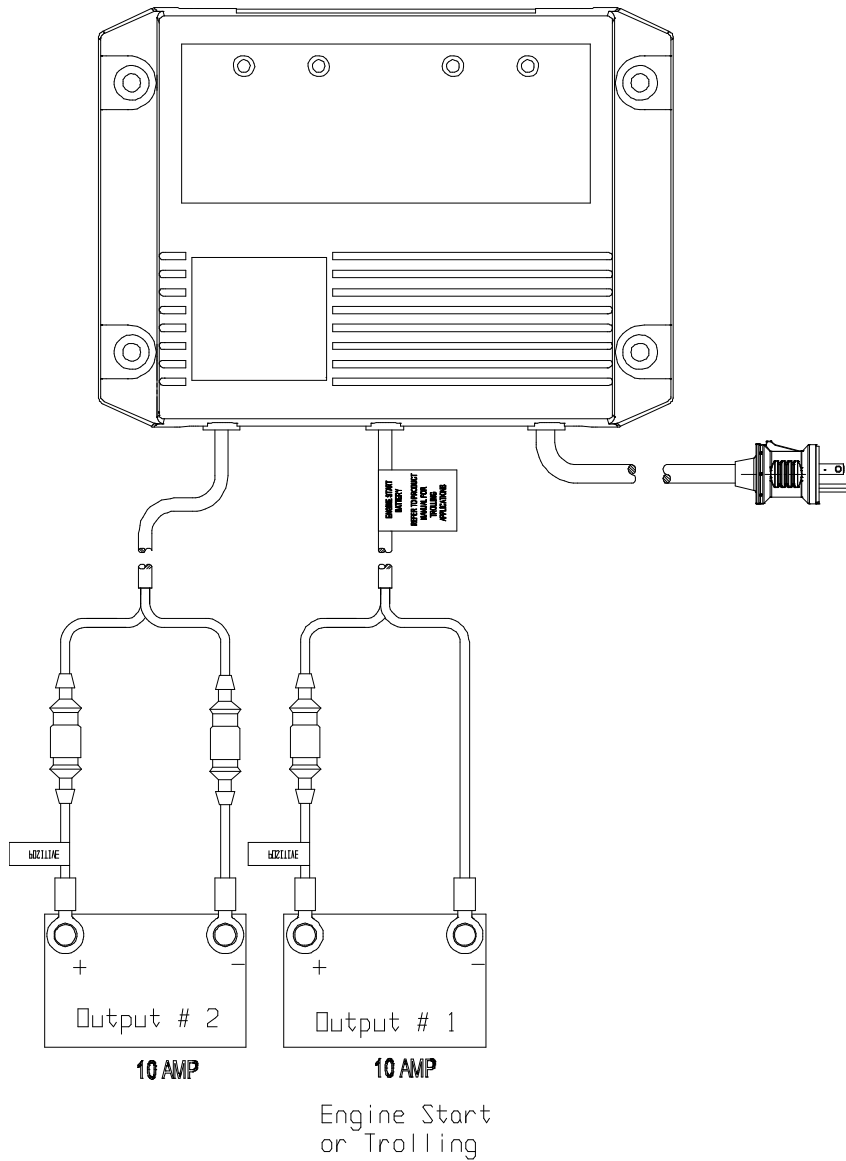

**NOTE: The 2620A can be used on 2 12 volt batteries or a 24V system. Outputs may also be paralleled for a single 12V 20 amp output.**

**Diagram 4. 2620A (10/10 Amps) used with 2 independent 12V Batteries**

For 24 Volt 10 Amp Single Output System

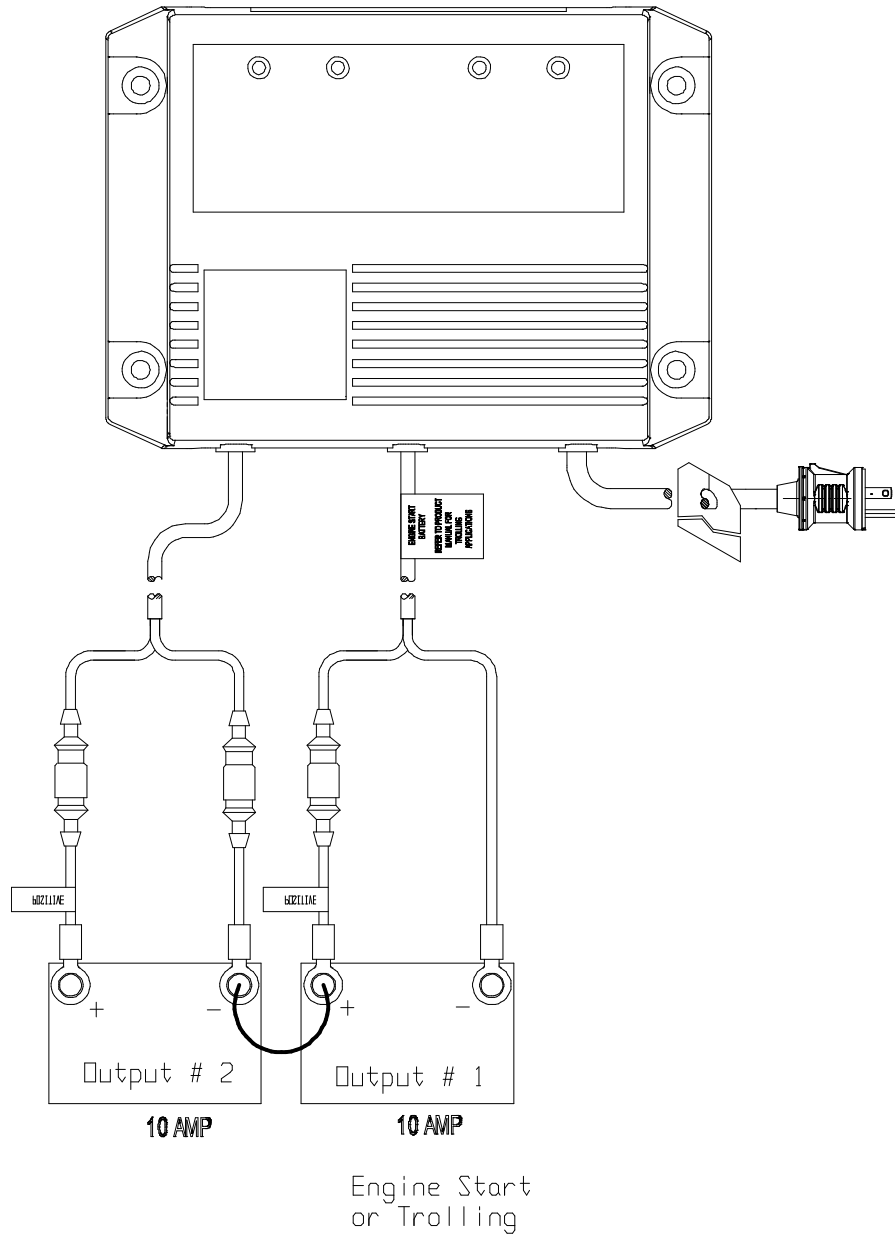

## 2623A Connections

Model	Output Volts	Output Amps	Banks	DC Cable Size	Size (inches) L x W x H	Input Volts	Input Amps Max
2623A	*12/24	10/5/10	3	6'6'6'	13 x 7 x 2.6	115VAC 50/60Hz	6.25 Amps

### \*Diagram 5. 2623A (10/5/10 Amps) used with 3 independent 12V Batteries

For 12 Volt 10 Amp, 5 Amp, 10 Amp System.

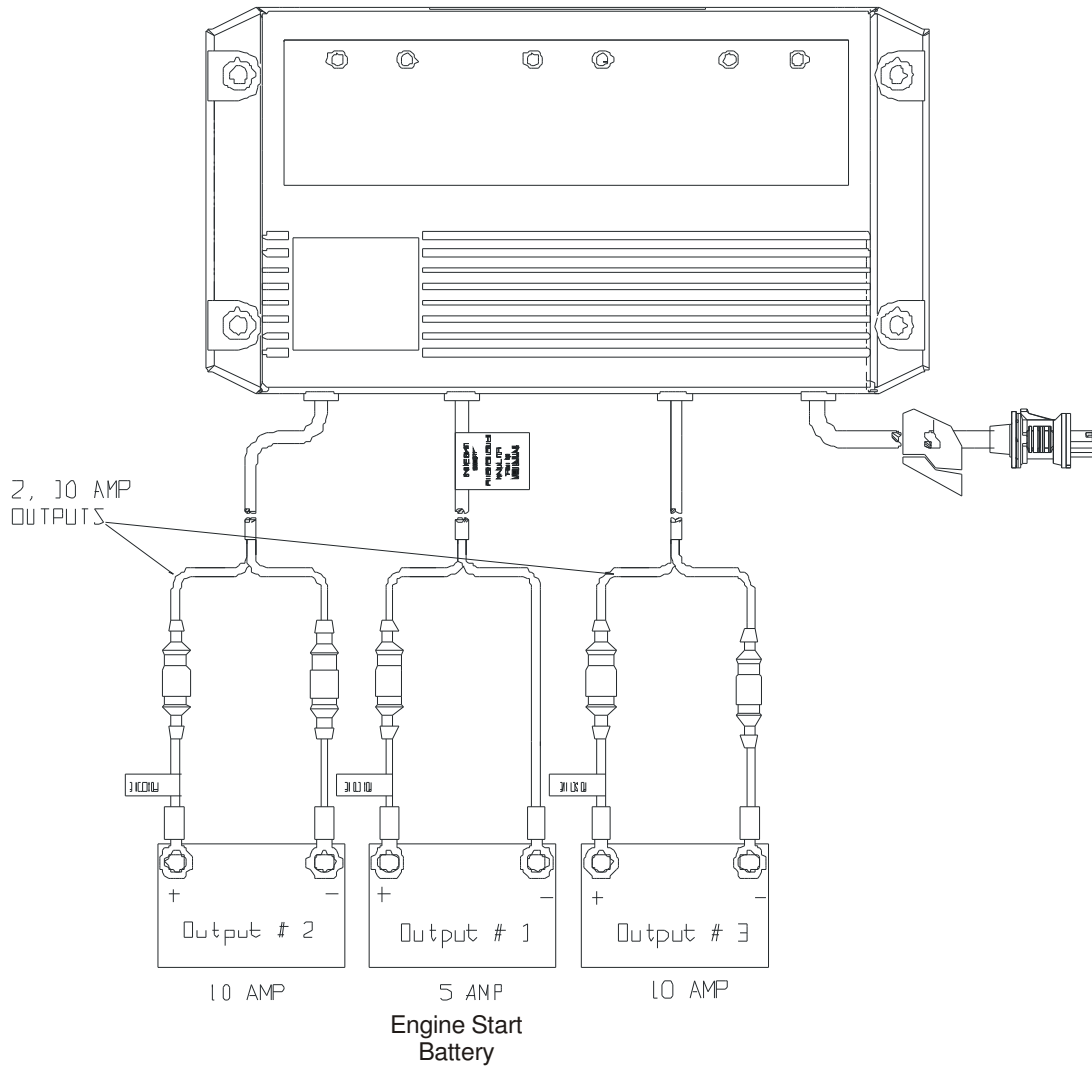



**\*2623A Connection Warnings:** For the 2623A, only output 1 and output 3 may be connected in parallel for a 12 V 20 amp output. The engine start output (Output 2) may NOT be connected in parallel with output 1 & 3. Output 1 and 3 may be connected in series for a 24 V system, the engine start output (Output 2) may NOT be connected in series with output 1 and 3.

**\*Diagram 6: 2623A used in a 24 V system**

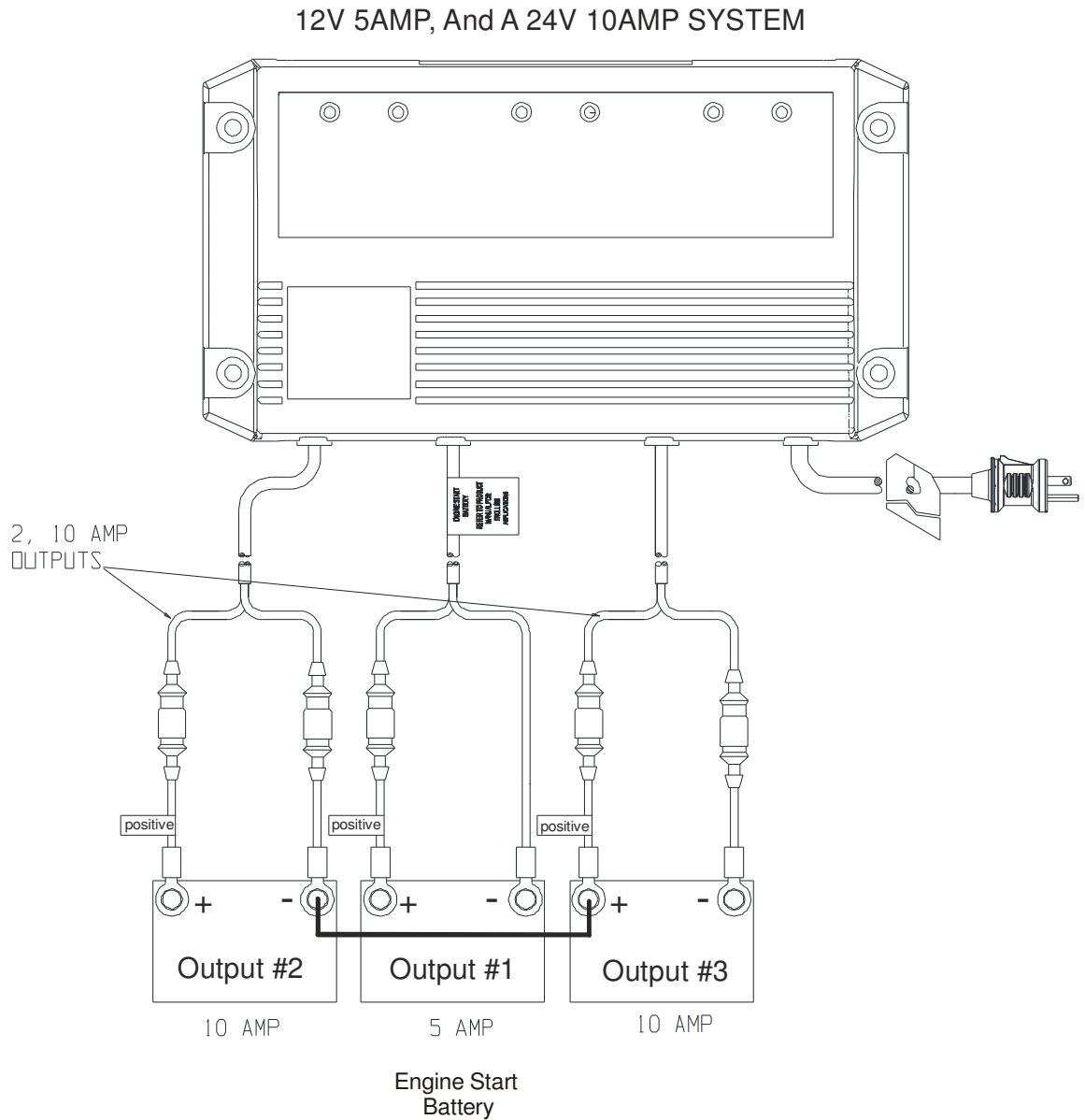

## 2631A Connections

Model	Output Volts	Output Amps	Banks	DC Cable Size	Size (inches) L x W x H	Input Volts	Input Amps Max
2631A	12/24/36	10/10/10	3	6'/6'/6'	13 x 7 x 2.6	115VAC 50/60Hz	7.5 Amps

**Diagram 7: 2631A (10/10/10 Amps) used with 3 independent 12V Batteries**

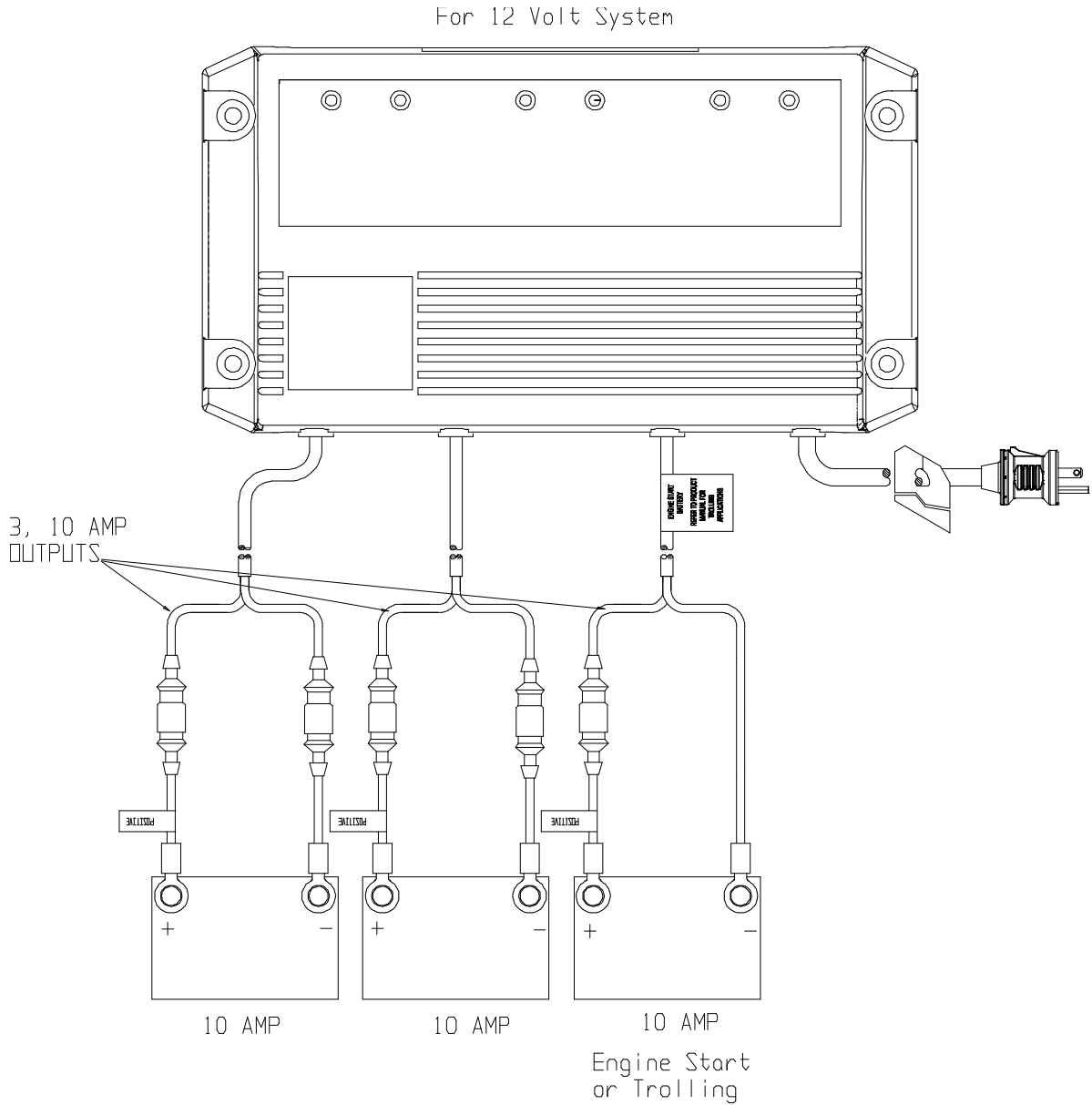

**NOTE: The 2631A can be used on 3 12-volt batteries, a 24V system, or a 36-volt system. Connections to the individual batteries are the same as shown above. For a 2-battery system use only 2 banks, leave 3<sup>rd</sup> disconnected.**

**Diagram 8: used in a 24 V and 12 V system**

2631: 12 Volt 10 Amp System and a 24 Volt 10 Amp System

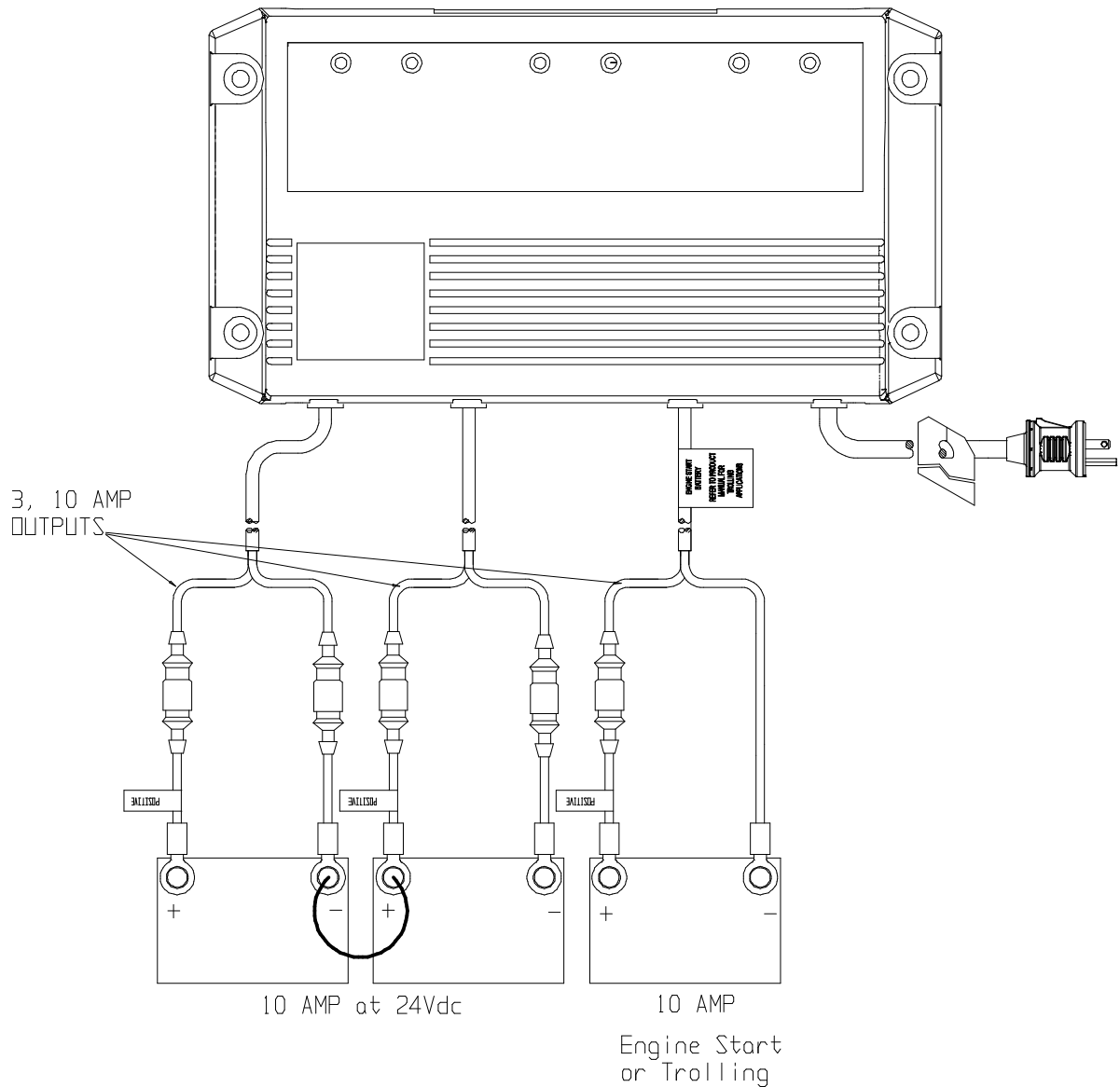





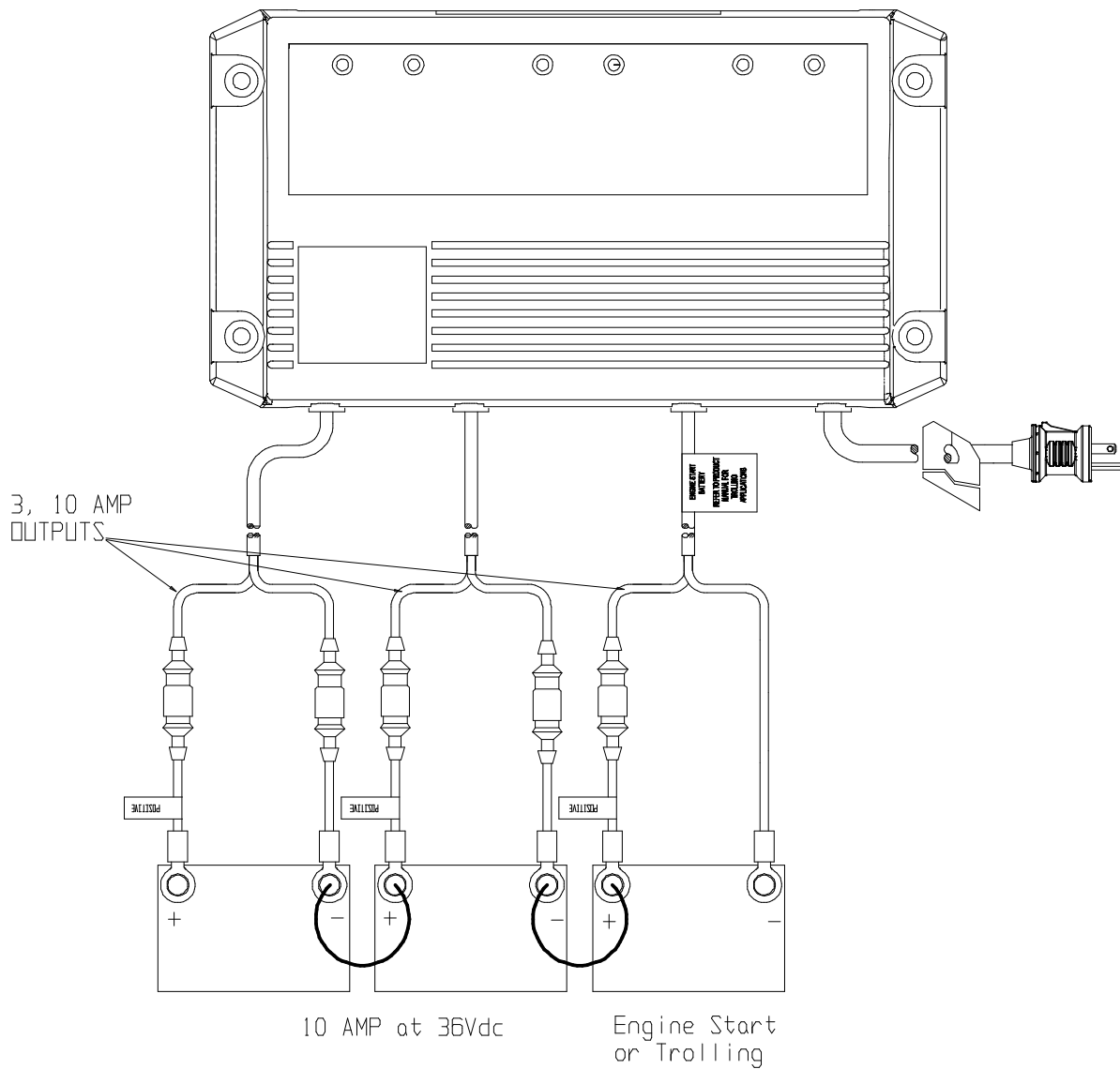

# Diagram 9: used in a 36 V system

2631: 36 Volt 10 Amp System









### 3. OPERATING THE CHARGER – 10 amp output

The LED Function Chart describes the charging process for any individual 10 Amp output.

Display	Operating condition
<p>Red </p> <p>Green </p>	<p>When the red LED is on, it indicates that your batteries are discharged and is recharging them at the "Charging" rate (stage 1). This charging rate is 10 Amps.</p> <p>While the red LED is on, the voltage measured (with the charger on) will be approximately 11.5 to 13 Volts.</p> <p>If the red LED stays on for more than 24 hours, refer to Problem 1 in the troubleshooting section in this manual.</p>
<p>Red </p> <p>Green </p>	<p>When both the green and the red LED's are on, it is charging at the "Finishing" rate. (stage 2). During this second charging stage, the charger holds the battery voltage at approximately 14.4 VDC, and then gradually reduces the amount of current (Amps) it delivers to the battery. By doing this, the battery is able to "absorb" the last 10% of charge as quickly as possible without becoming overheated.</p> <p>If both lights stay on longer than 24 hours, refer to Problem 2 in the troubleshooting section in this manual.</p>
<p>Red </p> <p>Green </p>	<p>When the battery approaches full charge, the charger switches into its third charging stage, gradually reducing the current fed to the batteries to as low as 0.1 Amps. At the same time, it reduces its output voltage to a "Float" or "Ready" charging rate of approximately 13.3 VDC, indicated by the green LED light. This low "Float" or "Maintenance" voltage gently "tops off" your batteries, keeping them fully charged and ready until needed. Now you can store your batteries at full charge indefinitely without overcharging. The green LED indicates that your batteries are now fully charged and ready for use.</p> <p>If the green LED stays on when your battery is known to be low, refer to Problem 3 in the troubleshooting section in this manual.</p>

# OPERATING THE CHARGER – 5 amp output

The LED Function Chart describes the charging process for any individual 5 Amp output.

Display	Operating condition
<p>Red </p> <p>Green </p>	<p>When the red LED is on, it indicates that your batteries are discharged and is recharging them at the "Charging" rate (stage 1). This charging rate is 5 Amps.</p> <p>While the red LED is on, the voltage measured (with the charger on) will be approximately 11.5 to 13 Volts.</p> <p>If the red LED stays on for more than 24 hours, refer to Problem 1 in the troubleshooting section in this manual.</p>
<p>Red </p> <p>Green </p>	<p>When both the green and the red LED's are on, it is charging at the "Finishing" rate. (stage 2). During this second charging stage, the charger holds the battery voltage at approximately 14.8 VDC, and then gradually reduces the amount of current (Amps) it delivers to the battery. By doing this, the battery is able to "absorb" the last 10% of charge as quickly as possible without becoming overheated.</p> <p>If both lights stay on longer than 24 hours, refer to Problem 2 in the troubleshooting section in this manual.</p>
<p>Red </p> <p>Green </p>	<p>When the battery approaches full charge, the charger switches into its third charging stage, gradually reducing the current fed to the batteries to as low as 0.1 Amps. At the same time, it reduces its output voltage to a "Float" or "Ready" charging rate of approximately 13.3 VDC, indicated by the green LED light. This low "Float" or "Maintenance" voltage gently "tops off" your batteries, keeping them fully charged and ready until needed. Now you can store your batteries at full charge indefinitely without overcharging. The green LED indicates that your batteries are now fully charged and ready for use.</p> <p>If the green LED stays on when your battery is known to be low, refer to Problem 3 in the troubleshooting section in this manual.</p>

## 4. TROUBLESHOOTING

Problem	Cause	Solution
1. Red LED stays on for more than 24 Hrs.	<ol style="list-style-type: none"> <li>1. One or more defective or damaged cells.</li> <li>2. Charger has reduced its output voltage below the normal level due to a DC overload or a DC short.</li> <li>3. On-board DC systems are drawing more current than the charger can replace.</li> </ol>	<ol style="list-style-type: none"> <li>1. Load test the batteries and replace if necessary.</li> <li>2. Remove the source of the overload or short. Disconnect the charger's black (NEGATIVE) ring terminal from the battery. Reapply AC power and the green LED only should now light.</li> <li>3. Turn off all DC equipment while charging.</li> </ol>
2. The red and green LED's stay on for more than 24 Hrs.	<ol style="list-style-type: none"> <li>1. On-board DC systems are drawing between 1.5 – 3.5A.</li> <li>2. One or more defective or damaged cells.</li> <li>3. Extremely low AC voltage at the battery charger.</li> </ol>	<ol style="list-style-type: none"> <li>1. Turn off all DC equipment while charging.</li> <li>2. Load test the batteries and replace if necessary.</li> <li>3. Apply a higher AC voltage source or reduce the length of the extension cord.</li> <li>4. Check battery manufacturer's specs on battery charging.</li> </ol>
3. Green LED stays on when the battery is known to be low.	<ol style="list-style-type: none"> <li>1. Open DC output fuse.</li> <li>2. Faulty or contaminated terminal connections.</li> <li>3. One or more defective or damaged cells.</li> </ol>	<ol style="list-style-type: none"> <li>1. Replace DC output fuse with a <u>Bussman</u> (AGC-14) 15 amp</li> <li>2. Clean and tighten or repair all terminal connections.</li> <li>3. Load test the batteries and replace if necessary.</li> </ol>
3. Neither of the LED's turn on when the AC power is applied.	<ol style="list-style-type: none"> <li>1. No AC power available at the charger</li> <li>2. Component failure</li> </ol>	<ol style="list-style-type: none"> <li>1. Connect AC power or reset the AC breaker on the main panel</li> <li>2. Return charger to the Guest Service Dept.</li> </ol>

## 5. MAINTAINING THE CHARGER

Periodically clean both battery terminals with baking soda and tighten all connections. No other maintenance on the charger is required.

# 6. SPECIFICATIONS

Model	Output Volts	Output Amps	Banks	DC Cable Size	Size (inches) L x W x H	Input Volts	Input Amps Max
2613A	12/24/36	5/5/5	3	6'4'4'	9.6 x 7 x 2.6	115VAC 50/60Hz	3.5 Amp
2620A	12/24	10/10	2	6'6'	9.6 x 7 x 2.6	115VAC 50/60Hz	5 Amps
2623A	*12/24	10/5/10	3	6'6'6'	13 x 7 x 2.6	115VAC 50/60Hz	6.25 Amps
2631A	12/24/36	10/10/10	3	6'6'6'	13 x 7 x 2.6	115VAC 50/60Hz	7.5 Amps

### FCC Class A EMC Notice

This equipment has been tested and found to comply with the limits for a Class A digital device, pursuant to part 15 of the FCC Rules. These limits are designed to provide reasonable protection against harmful interference when the equipment is operated in a commercial environment. This equipment generates, uses and can radiate radio frequency energy and, if not installed and used in accordance with the instructions, may cause harmful interference to radio communications. Operation of this equipment in a residential area is likely to cause harmful interference in which case the user will be required to correct the interference at his own expense.

If this equipment does cause harmful interference to radio or television reception, which can be determined by turning this equipment off and on, the user is encouraged to try to correct the interference by one or more of the following measures:

- Reorient or relocate the receiving antenna.
- Increase the separation between the equipment and receiver.
- Connect the equipment into an outlet on a circuit different from that to which the receiver is connected.

### LIMITED WARRANTY

For two (2) years from the date of purchase, The Guest Co. will, at its discretion, repair or replace for the original consumer, free of charge, any parts found defective in material or workmanship.

This product is guaranteed for life against water damage.

Proof of purchase is required: A computerized register receipt is required. Hand-written receipts are not accepted for warranty proof of purchase.

There is no other expressed warranty. Implied warranties, including those of merchantability and fitness for a particular purpose, are limited to one year from the date of purchase. This is the exclusive remedy and consequential damages are excluded where permitted by law.

Tel: (707) 226-9600  
 Fax: (707) 226-9670

Email: info@marinco.com  
 Website: www.marinco.com