

# **Dual Digital Display**



## EMC Conformance

All Tacktick equipment is designed to the best industry standards for use in the recreational marine environment. The design and manufacture of Tacktick equipment conforms to the appropriate Electromagnetic Compatibility (EMC) standards. Correct installation is required to ensure that performance is not compromised.



### Important

Due to the wireless communication systems used in Micronet instruments they are only recommended for use on boats up to 18 metres (60 ft.) **Before installing to a boat of aluminium or steel construction, please contact your Tacktick dealer.**

Like any other Electronic instruments your Micronet system is designed to serve only as an aid to navigation and it remains the skippers responsibility to maintain a permanent watch and be aware of developing situations.

<b>1</b>	<b>Information</b>	Page
1.1	Introduction -	2
1.2	Specifications	2
1.3	Power Management and Battery Life -	2
1.4	Safety and Disposal -	4
<b>2</b>	<b>Operation</b>	
2.1	Display Information -	5
2.2	Switching the System On and Off -	6
2.3	Backlighting -	6
2.4	Audible Signals and Alarms -	6
2.5	Utilities -	8
2.6	Chapter and Page Operation -	9
2.7	Chapter and Page Description -	11
<b>3</b>	<b>Setup and Calibration</b>	
3.1	Entering Setup and Calibration Mode -	18
3.2	Chapter and Page Setup and Calibration -	18
3.3	Editing Values -	18
3.4	Setup Page Description -	20
3.5	Calibration Page Description -	23
<b>4</b>	<b>Seatrial and Calibration</b>	
4.1	Depth Offset -	29
4.2	Speed Calibration -	30
4.3	Wind Calibration -	31
4.4	Compass Calibration and Alignment -	32
<b>5</b>	<b>Installation</b>	
5.1	Tools List & Parts-	33
5.2	Precautions and Positioning Advise -	33
5.3	Bracket Mounting -	34
5.4	Surface Mounting -	35
5.5	External Power Connections -	36
<b>6</b>	<b>Maintenance and Fault Finding</b>	
6.1	Care and Maintenance -	37
6.2	Fault Finding and Technical Support -	37
<b>7</b>	<b>Warranty Information</b>	

# 1 Information

## 1.1 Introduction

Your Micronet display is powered for life by the environment. Although feature packed and highly visible in all conditions, current demand is so low, and the supply so efficient, that the solar-powered display is self sufficient. Combined with other displays in the Micronet range this display becomes part of a complete navigational system.

## 1.2 Specifications

**Height of digits:** 20mm (0.8")

**Backlighting:** 3 levels with daylight shutoff  
System-wide or local control

**Power:** Solar Powered  
300 hrs autonomy by day, 7 nights at brightest  
backlighting,  
20 nights at economy backlighting without charge

**Units of display:** Boat Speed (knots, km per hour, statute miles per hour)  
Distance (nautical miles, statute miles, kilometres)  
Depth (metres, feet, fathoms)  
Wind Speed (knots, metres per second, Beaufort)

**Alarm:** Audible Alarm for Depth, Wind and MOB

**Weight:** 285g (0.63lbs)

**Operating Temp.:** 10<sup>o</sup> to +60<sup>o</sup>C (14<sup>o</sup> to 140<sup>o</sup>F)

**Frequency:** 868 MHz or 916 MHz

















**This unit can be controlled using the T113 Remote Display**

## 1.3 Power Management and Battery Life

What makes your mn100 display possible is Tacktick's revolutionary approach to power management. By reducing the amount of power being used by the electronics and maximizing the potential of the sun to provide power, a mn100 display becomes a virtually perpetual device. Power status is indicated by two icons on the display:

Battery Level  and  Charge Rate

Used together these icons will show the condition of the power supply.

Bright Sunny Day 	 	Battery is charged and being topped up by the sun. (see Note)
	 	Battery is low and being charged by the sun.
Overcast Day 	 	Battery is charged and requires no further charging.
	 	Battery is low but maintaining it's level.
Night 	 	Battery is charged but is not charging.
	 	Battery is low with no charging.
LOW Power	 	It is recommended that the instrument be left in daylight for some time for the battery to recover, or charge from an external 9-30V power source. A fully discharged battery will recharge in approximately 12 hours of direct bright sunlight.

If using the displays at night, power usage can be reduced dramatically by switching the Backlighting to level 1 or Off. If Backlighting is not required on displays located below decks it is best to set them to "Local" Backlighting control (see page 27 -s37) so that power is not being wasted in displays which may not be visible from the one being viewed.

**Note** If the internal battery is fully charged then it does not matter how much the display is subjected to bright sunlight no further charging is required and the Charge Rate Indicator will remain low.



If the displays are to be stored for a long period of time before next use (Over Winter) ensure that the batteries are fully charged before storage. If necessary connect to a 9-30V DC power supply for 24 hrs prior to storage.

## Sleep Mode

If there is no boat speed or change in heading registered on the system for a period of 12 hours your Micronet display will switch off to conserve power. A "POWER SAVE" alarm will sound before the system switches off. Pressing any button within 10 seconds of the alarm sounding will allow the system to remain switched on.

Backlighting will automatically shut down/off when operated in daylight.



**Artificial light WILL NOT recharge the battery.** Placing your Micronet display close to an artificial light will seriously damage the display. Only recharge in natural daylight.

## Applying External Power

In cases where displays are mounted permanently below decks it will be necessary to apply an external power source to prevent complete discharge of the built in battery.

Connections on the rear of the display allow a 9V to 30V DC power source to be connected. Connections can be made to the vessels DC system or a 9V battery pack may be connected. It is recommended that permanent connection is only made when the displays are permanently fixed to the vessel and not when the clip brackets are used.

Connection to a 9V (PP3) battery will fully recharge the internal battery over a period of 24 hours.

## 1.4 Safety and Disposal

Your Micronet display contains Manganese Lithium Dioxide batteries which should be disposed of correctly. Do not dispose of any instrument in domestic waste. Refer to regulations in force in your country. If in doubt return the instrument to Tacktick Ltd. for correct disposal.

## 2 Operation



### Important:

Ensure that the "Auto Network" procedure described on the yellow instruction sheet and full Setup and Calibration has been performed correctly before attempting to use your Micronet system.

### 2.1 Display Information

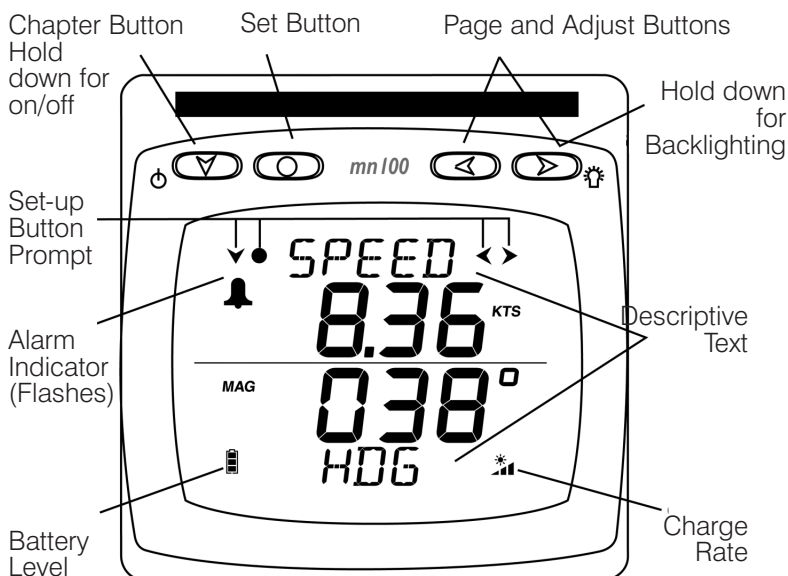

### Display Icons

The following icons are used to display information on the screen:

**KTS, KPH, MPH** to display speed units

**KTS, M** to display wind speed units

**TRUE, APP** to indicate True or Apparent wind

**TRUE, MAG** to indicate True or Magnetic bearings and headings

**LAT, LON** to indicate Latitude or Longitude

**LOG, TRIP** to indicate a Total Logged or Trip distance

**°** to indicate degrees of angle or temperature

## 2.2 Switching the System On and Off

To switch your Micronet system on or off select any display and press the  button for 2 seconds.

### Switch on



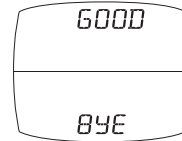

### Switch off

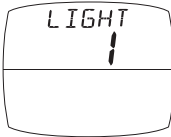

## 2.3 Backlighting



At any stage of the display's operation press and hold for 2 seconds the  button to access the lighting control.

Pressing the  and  buttons will scroll through setting OFF, 1, 2 and 3 whilst changing the Backlighting.

Depending on the display setup (see page 27 -s37), Backlighting on the whole system or just the single display will be altered.



Backlighting is automatically switched off in daylight as part of the display's power saving feature and will not operate in daylight.

## 2.4 Audible Signals and Alarms

At stages during its operation your Micronet display will beep to indicate alarms or moments of importance.

### Power-up

Once operating as part of a network the display will issue a single beep as it is switched on by pressing the  button for 2 second.

### Button Press

A single beep is issued each time a button is pressed. A second beep is issued after a 2 second hold down of the  button.

### Timer

A single beep will be issued at each minute of the countdown. With 1 minute left to go a beep will sound every 10 seconds. With 10 seconds to go a beep will sound every second.

Countdown complete will be indicated by a single burst of three beeps.



## Alarm

Continuous bursts of three beeps will indicate an alarm. The alarm activated will be indicated on the digital display, accompanied by the flashing  symbol. Pressing any button will silence the alarm. See fault finding section on p37.

### Depth Shallow Alarm

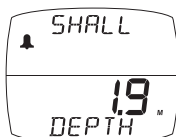

The water depth has fallen below the preset alarm level. The depth value that triggers the alarm is affected by any keel or waterline offsets that have been added.

See page 22 s11 to set the alarm function.

This alarm does not sound as the depth increases above the preset alarm level.

### Depth Deep Alarm

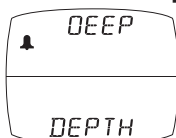

The water depth has increased above or fallen below the preset alarm level.

The depth value that triggers the alarm is affected by any keel or waterline offsets that have been added.

See page 22 s12 to set the alarm function.

### Off Course Alarm

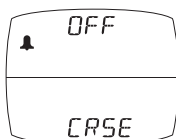

The heading has deviated from its locked value by more than the preset alarm level

See page 22 -S13 to set the alarm function

See page 17 -P33 to lock a heading

### Wind High Alarm

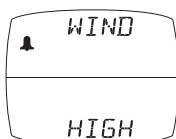

The wind speed has increased beyond the preset alarm level.

See page 22 s14 to set the alarm function.

This alarm does not sound as the wind speed decreases below the preset alarm level.

### Cross Track Error Large Alarm

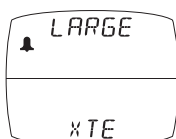

A large cross track error has been alerted by the GPS.

See page 23 s15 to set the alarm function.

### Waypoint Arrival Alarm







A waypoint arrival signal has been received from the GPS. The waypoint name is shown on the top of the display.

See page 23 s16 to set the alarm function



## 2.5 Utilities

### Keylock

The Keylock feature protects from accidental key presses and is intended for use in high activity applications such as crewed race yachts. If your display is mounted in a position where keys may be pressed accidentally (eg the companionway of a race yacht), then you can enable keylock as follows:





- Press and hold  to enter set up
- Press  repeatedly to reach the **OPTS** chapter
- Press  repeatedly to reach the **Key Lock** page
- Press  to activate keylock
- Press and hold  to exit setup.





Once keylock is activated, pressing a key causes the unit to give the unlock key prompt. Press  followed by  to unlock the keys (this will allow the keys to function for one minute, after which the keys will automatically relock).

### Page Hiding

To hide unwanted pages and configure an instrument to your needs:





- Press and hold  to enter set up
- Press  repeatedly to reach the **OPTS** chapter
- Press  repeatedly to reach the **Page Hiding** page
- Press  to activate page hiding for 5 minutes
- Press and hold  to exit setup.



Once page hiding is activated, press  for 2 seconds to hide a top page or press  for 2 seconds to hide a bottom page. A period of 5 minutes is allowed during which you can select pages to hide.



### Page Unhide

To clear Page Hiding and return to all pages visible:

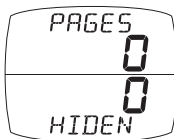
- Press and hold  to enter set up
- Press  repeatedly to reach the **OPTS** chapter
- Press  repeatedly to reach the **Pages Hidden** page
- Press  to clear page hiding
- Press and hold  to exit setup.



## 2.6 Chapter and Page Operation

Information is displayed in a “Chapter and Page” format using the  (Chapter) button to scroll through the Chapters which are displayed in the upper part of the window and the  and  (Page) buttons to move between Pages within a Chapter which are displayed in the lower part of the window.

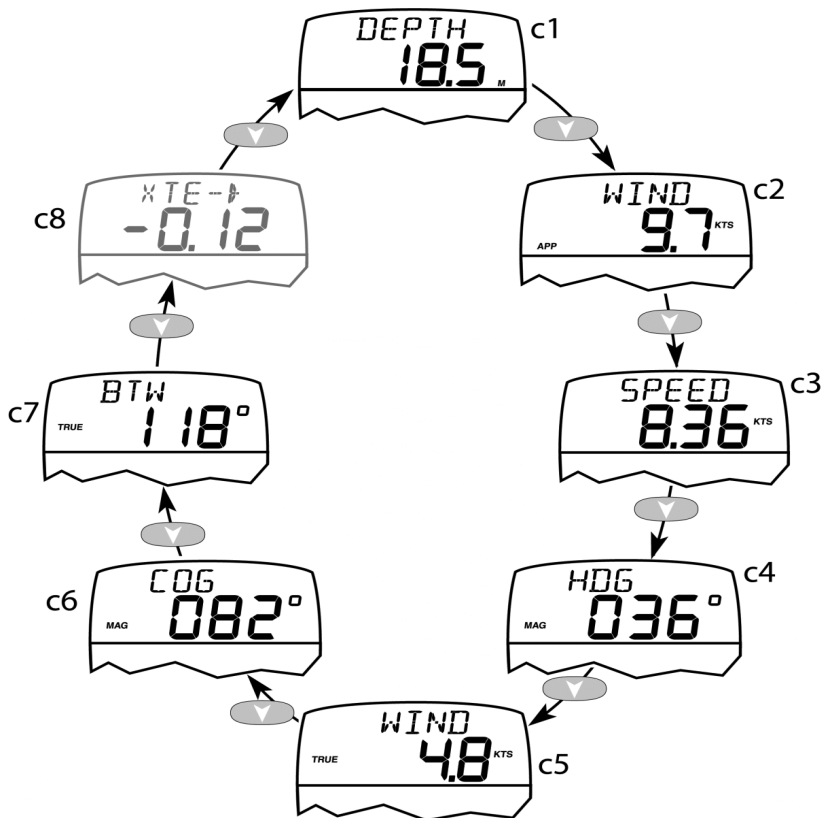

037\_003

*Chapter Sequence Shown in Upper Window  
(for a full description of each Chapter see page 11 - c1 to c8)*

It is possible to select any Page (lower window) within any Chapter (upper window) giving you a chance to display any two pieces of information available at any time.

Once a Page display has been selected within a Chapter the same Page will be displayed every rollover of the Chapter sequence ensuring that you return to your choice of display within a maximum of 8 presses of the (Chapter) button.

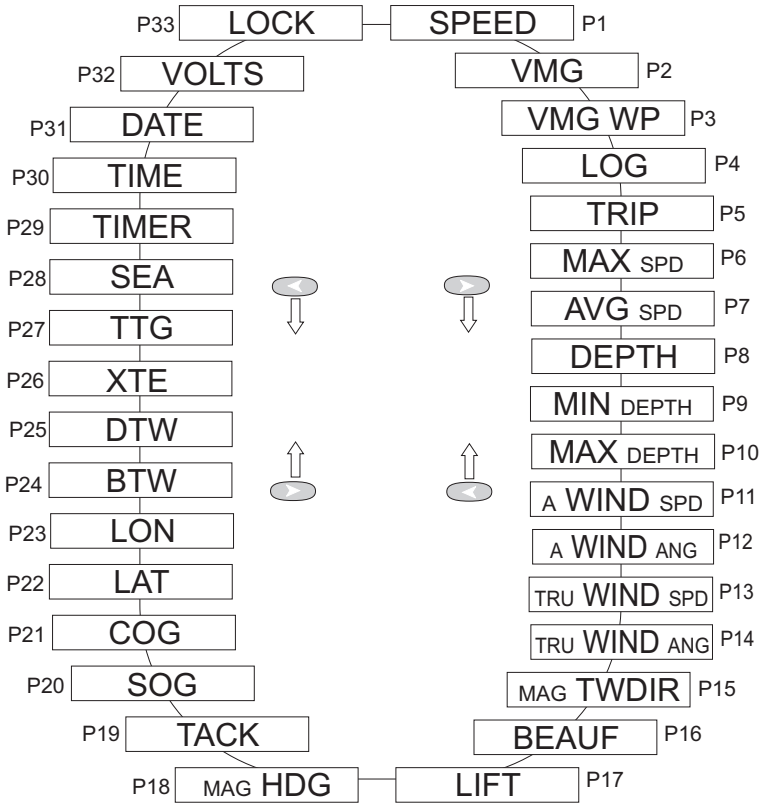

*Full Page Selection List Shown in Lower Window  
(for a full description of each Page see page 12 -p1 to p33)*

To move through the pages in chapter groups, press and hold . To then move individually page by page, let go of and step forward and back with a single press of and buttons.

## 2.7 Chapter and Page Descriptions

### Chapters

#### C1 Depth



The Actual Depth beneath the vessel as measured by the Depth Transducer. The displayed value will be affected by any keel or waterline offset added (see page 29).

#### C2 Apparent Wind Speed



The actual Wind Speed with respect to the vessel as measured by the Wind Transmitter.

#### C3 Boat Speed



The vessels actual speed through the water as measured by the Speed Transducer.

#### C4 Heading



Current Compass Heading of the vessel as measured by the Compass Transducer. The value displayed will be affected by the calibration routine for the compass (see page 32).

#### C5 True Wind Speed



The True Wind Speed with respect to the vessel, calculated by the display taking into account the vessels speed through the water. Both Apparent Wind Speed, Angle and Boat Speed must be available for this calculation.

#### C6 Course Over the Ground



Course Over the Ground as calculated by the GPS Antenna.

#### C7 Bearing to Waypoint



Bearing To (active) Waypoint. The active Waypoint being the one to which the GPS is currently navigating.

#### C8 PROG (Custom Chapter)

A Custom Chapter which allows you to select from a full list the information you wish to display in the Chapter (upper) window (see page 26 -s35 for selection). This chapter is not displayed if no Custom Chapter has been defined in Setup.

## Pages

### P1 Boat Speed



The vessels Actual Speed through the water as measured by the Speed Transducer.

### P2 Velocity Made Good to windward



The vessels calculated Speed Directly Upwind. This value is calculated by the display from the Boat Speed and True Wind Angle.

### P3 Velocity Made Good to waypoint



The vessels calculated Speed directly towards the active Waypoint. This value is calculated by the GPS Antenna.

### P4 Log distance

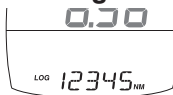

The total distance travelled by the vessel since installation of the display or since a Factory Reset.

### P5 Trip distance



The distance travelled since the last Trip Reset. To Reset see page 20 -s1.

### P6 Maximum Speed (Identified by displayed KTS/KPH/MPH icon)



The Maximum Speed attained since the last reset. To Reset see page 20 -s4.

### P7 Average Speed (Identified by displayed KTS/KPH/MPH icon)

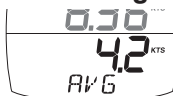

The Average Speed attained since the last reset. To Reset see page 20 -s5.

### P8 Depth



The Actual Depth beneath the vessel as measured by the Depth Transducer. The displayed value will be affected by any keel or waterline offset added (see page 29).

### P9 Minimum Depth (identified by displayed FT/M/FTM icon)



The Minimum Depth encountered since switch on or since the last Minimum Depth Reset. To Reset see page 20 -s2.

**P10 Maximum Depth (identified by displayed FT/M/FTM icon)**

The Maximum Depth encountered since switch on or since the last Maximum Depth Reset. To Reset see page 20 -s3.

**P11 Apparent Wind Speed (identified by displayed KTS/M icon)**

The Actual Wind Speed with respect to the vessel as measured by the Wind Transmitter.

**P12 Apparent Wind Angle**

The actual Wind Angle with respect to the vessel as measured by the Wind Transmitter.

**P13 True Wind Speed (identified by displayed KTS/M icon)**

The True Wind Speed with respect to the vessel, calculated by the display taking into account the vessels speed through the water. Both Apparent Wind Speed, Angle and Boat Speed must be available on the network for this calculation.

**P14 True Wind Angle**

The True Wind Angle with respect to the vessel, calculated by the display taking into account the vessels speed through the water. Both Apparent Wind Speed, Angle and Boat Speed must be available on the network for this calculation.

**P15 True Wind Direction**

The Actual Wind Direction over the water, calculated by the display taking into account the vessels speed through the water and compass heading. Apparent Wind Speed, Direction and Compass Heading must be available on the network for this calculation.

**P16 Beaufort Wind Strength**







The Actual Wind Speed over the water displayed using the Beaufort scale, calculated by the display taking into account the vessels speed through the water and compass heading. Apparent Wind Speed, Direction and Compass Heading must be available on the network for this calculation.



### P17 Wind Shift, Head or Lift



Indicates changes in the wind against a compass heading. Spotting these wind changes is the key to fast sailing upwind.

The system automatically detects the mean wind direction by averaging over a time period of 2 minutes to 60 minutes (this time period can be changed in setup). However, to manually override this automatic calculation and set the mean wind direction:

1. If a Wind Transmitter is included in your Micronet system then simply press the  button; (the current wind direction is stored as the mean wind direction and displayed for 5 seconds during which time the  and  buttons may be used to adjust the value.) If the mean wind direction changes, press  again.
2. If you do not have a Wind Transmitter included, sail close hauled and press the  button then tack and, once close hauled, press the  button again.

If the mean wind direction changes then the instrument may be updated press and holding the  button while sailing on port tack, the  button while sailing on starboard tack or the  button while head to wind.

See Tacktick's "Using wind shifts to your advantage" sheet for further information.

### P18 Heading



Current Magnetic Compass Heading of the vessel as measured by the Compass Transducer. The value displayed will be affected by the calibration routine for the compass (see page 32).

### P19 Heading on opposite tack



Magnetic Compass heading which the vessel will follow should it tack through the wind, calculated by the display. Apparent Wind Angle and Magnetic Heading must be available on the network for this calculation to be made.

### P20 Speed Over the Ground

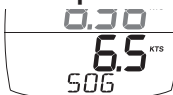







Vessels Speed Over the Ground as calculated by the GPS Antenna.

### P21 Course Over the Ground

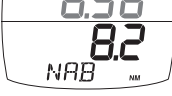

Vessels Course Over the Ground as calculated by the GPS Antenna.



- P22 Latitude**  Vessels current Latitude as calculated by the GPS Antenna.
- P23 Longitude**  Vessels current Longitude as calculated by the GPS Antenna.
- P24 Bearing to Waypoint**  Bearing To (active) Waypoint. The active Waypoint being the one to which the GPS is currently navigating.
- P25 Distance to Waypoint**  Distance To (active) Waypoint. The active Waypoint being the one to which the GPS is currently navigating. When the Waypoint has been named in the GPS the name will be displayed (first five digits only).
- P26 Cross Track Error**  Cross Track Error as defined by the GPS Antenna.
- P27 Time to Go to Waypoint**  The calculated time remaining before you will arrive at the (active) waypoint as calculated by a GPS receiver or plotter.
- P28 Sea Temperature**  Current Sea Temperature as measured by the sensor in the Speed Transducer.

## P29 Timer

Countdown or elapsed time stopwatch.

Press and hold for 1 second the  button and use the  and  buttons to set the required countdown time in minutes.

Press and hold for 1 second the  button to prepare to start the countdown.

Press the  button quickly to start the countdown.

The display will sound a single beep each 30 seconds until 1 minute remains when a beep will sound at 10 second intervals. The final 10 seconds will count down with a beep each second with "START" being indicated by a triple quick beep at 0. The timer will automatically start to count the elapsed time and this will continue until the  button is pressed and held for one second.

At any stage a quick press of the  button will resynchronise the timer to the nearest full minute and then carry on the count down.

### Example:

Press  at 3mins 24secs the timer will reset to 3mins 0 secs

Press  at 7mins 52secs the timer will reset to 8mins 0 secs



Press and hold for 1 second to enter the timer setup

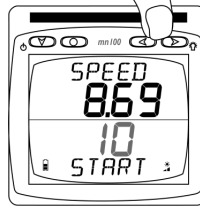

Select the desired countdown time

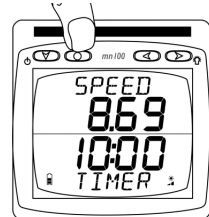

Press and hold for 1 second to store the countdown time

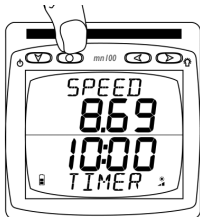

Press to start

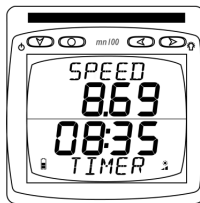

Countdown time in progress

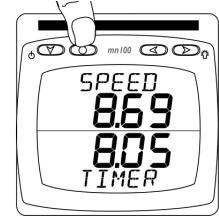

Press to resynchronise to nearest full minute (8:00)

**P30 Time**

Current Time as received from the GPS Antenna corrected to local time if an offset has been added (see page 26 -s36).

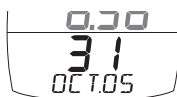
**P31 Date**

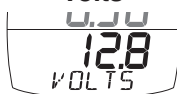

Current date as received by the GPS Antenna.

**P32 Volts**

The voltage connected to the PWR input of the hull transmitter or the Wireless (NMEA) Interface.

**P33 Lock**

Produces a "Trim" indication showing an increase or decrease in value from a set point.

Select the appropriate chapter in the upper display using the  button.

Select "Lock" in the lower display using the  or  buttons.



Press the  button to lock the upper display value, the lower display will now indicate increase or decrease from the set value.

Values displayed as units will show a percentage (%) increase or decrease whereas values displayed as degrees will show the difference in degrees.



Heading locked at 269° now showing +008 change meaning current heading is 277°

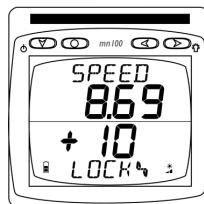

Speed locked at 8.69 kts now showing +10% change meaning current speed is 9.56 kts)

## 3 Setup and Calibration



### 3.1 Entering Setup and Calibration Mode

To enter the Setup and Calibration menu press and hold for 2 seconds the  button.



This will not work when in the Race Timer page.

### 3.2 Chapter and Page Setup and Calibration

Setup and Calibration is displayed in a “Chapter and Page” format using the  button to scroll through the Chapters and the  and  buttons to move between Pages. The diagram below shows the information format.

**Note:** Unlike normal operation you must scroll to the Chapter heading page before moving to another chapter.

### 3.3 Editing Values

To adjust any settings press the  button. The setting will start to flash and the  and  buttons will change the value. Then press the  button again to save the new setting.

## Setup and Calibration - Chapter and Page layout

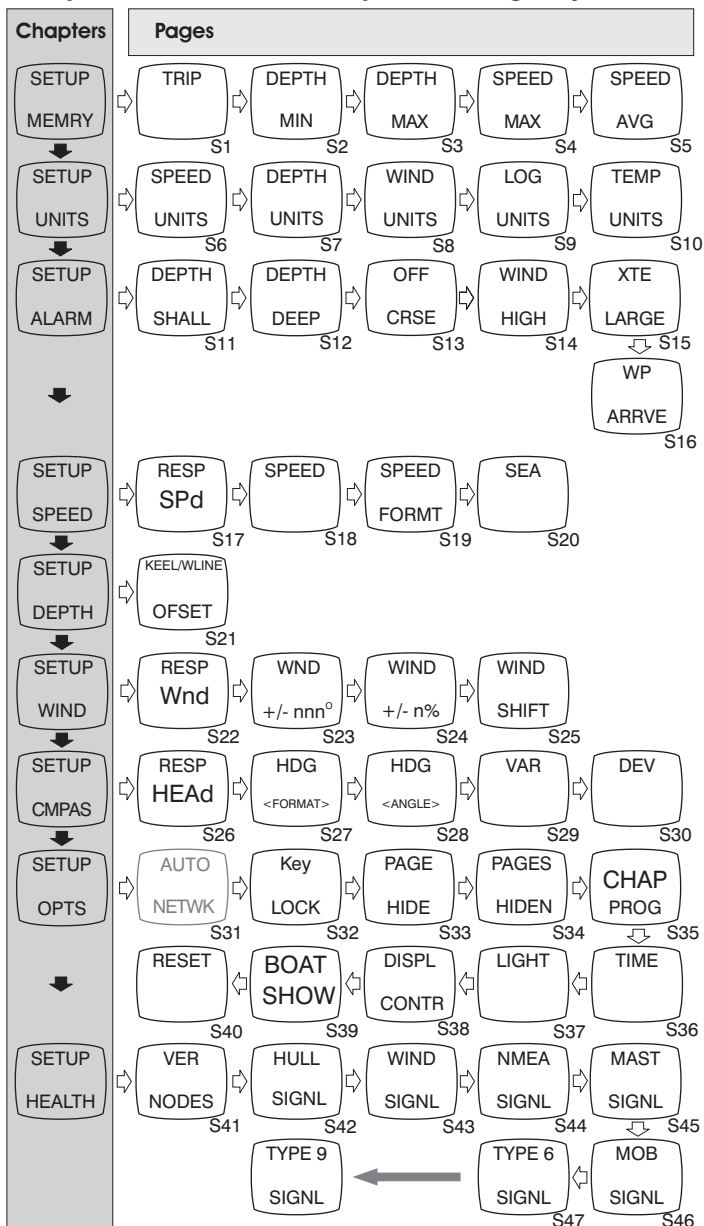

For a full description of each Page refer to items s1 to s47 on the following pages

### 3.4 Setup Page Description

#### SETUP MEMRY - Memory Chapter

In each case press the  button quickly to reset.

##### S1 Trip Distance

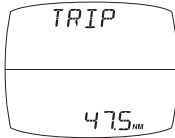

The Distance Travelled since the last Trip Reset. Resets to 0.00.

##### S2 Depth Minimum

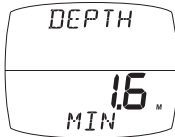

The Minimum Depth encountered since switch on or since the last Minimum Depth Reset. Resets to Current Depth.

##### S3 Depth Maximum

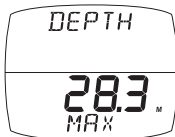

The Maximum Depth encountered since switch on or since the last Maximum Depth Reset. Resets to Current Depth.

##### S4 Speed Maximum





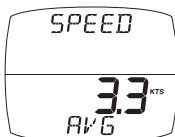

The Maximum Speed attained since switch on or since the last Maximum Speed Reset. Resets to Current Boat Speed.

##### S5 Speed Average



The average speed attained since switch on or since the last Average Speed Reset. Reset to Current Boat Speed.

## SETUP UNITS - Units Chapter

In each case press the  button quickly to edit, press the  or  button to change units and press the  button quickly to select the chosen units. Default values are indicated in bold.

### S6 Speed

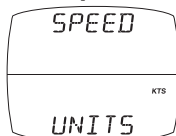

The units in which ALL speed related information is displayed.

The options available are: **Knots (KTS)**, Kilometres per hour (KPH) or Statute Miles per hour (MPH).

### S7 Depth

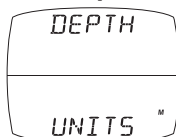

The units in which ALL depth related information is displayed. The options available are: **Feet (FT)**, Metres (M) or Fathoms (FTM).

### S8 Wind

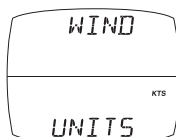

The units in which ALL wind speed related information is displayed.

The options available are: **Knots (KTS)** or Metres per second (M).

### S9 Distance

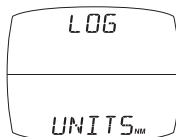

The units in which ALL distance related information is displayed.



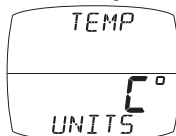

The options available are: **Nautical Miles (NM)**, Kilometres (KM) or Statute Miles (SM).

### S10 Temperature



The units in which the Sea Temperature reading is displayed. The options available are: **Degrees Celsius (C°)** or Degrees Fahrenheit (F°).

## SETUP ALARM - Alarms Chapter

In each case press the  button quickly to edit, press the  or  to change values and press the  button quickly to save the entered value. In the case of On/Off selection the  button will toggle the setting On and Off. Default values are indicated in bold.

### S11 Shallow Water Alarm



Sets the Shallow Depth at which the display will alarm.

The options are: **OFF** and 0.0 to 25 feet (0.0 to 7.6 metres) (0.0 to 4.1 fathoms).

Values are displayed in the previously selected units (see page 21 -s7 to select units) and are all subject to any keel or waterline offset added (see page 24 -s21 to set an offset).

This alarm sounds as the depth passes below the set value and NOT as the depth increases past this value.

### S12 Deep Water Alarm



Sets the Deep Depth at which the display will alarm.

The options are **OFF** and 0.0 to 250 feet.(0.0 to 76.2 metres) (0.0 to 41.6 fathoms).

Values are displayed in the selected units (see page 21 -s7) and are all subject to any keel or waterline offset added (see page 24 -S21 to set an offset).

This alarm sounds as the depth increases past this value or decreases past this value.

### S13 Off Course Alarm



Sounds if the vessel turns further than the set angle away from a "Locked" heading (see page 17 -p33).

**Off**/**<value in degrees>**

### S14 High Wind alarm

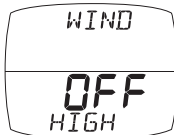

Sets the Wind Speed at which the display will alarm.

The options are: **OFF** and 0.0 to 100 knots (0.0 to 51.4 m/s). Values are displayed in the previously selected units (see page 21 -s8 to select units).

This alarm sounds as the wind speed increases past the set value and NOT as it decreases past this value.



### S15 Cross Track Error Alarm



Sets the display to alarm if a Large Cross Track Error alarm is issued by the GPS.

The options are: On/**Off**.



### S16 Waypoint Arrival Alarm



Sets the display to alarm if a Waypoint Arrival alarm is issued by the GPS.

The options are: On/**Off**.

## 3.5 Calibration Page Description

In each case press the  button quickly to edit, press the  or  button to change units and press the  button quickly to select the chosen units. Default values are indicated in **bold**.

### SETUP SPEED - Speed Chapter

#### S17 Speed Response



Sets the update period of the Speed display.

The options are: **Auto**/Slow/Medium/Fast

#### S18 Speed Calibration

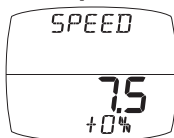

The Boat Speed Calibration Factor adds a percentage factor which corrects the information from the Speed Transducer and ensures the Boat Speed is displayed correctly.

See page 29 for the calibration factor.

#### S19 Speed Display Format

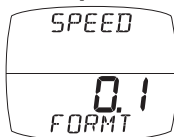

Sets the number of decimal places to which the boat speed information is displayed

Applies to the units selected on page 21 -S6.

The options are: **0.1** or 0.01.

## S20 Sea Temperature Calibration

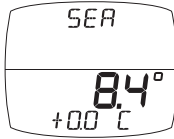

The sea temperature calibration factor adds a value which corrects the information from the temperature sensor and ensures the water temperature is displayed correctly.

## SETUP DEPTH - Depth Chapter

### S21 Keel/Waterline Offset

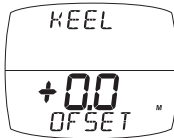

Allows a keel offset to be added allowing the display depth reading to indicate depth below the bottom of the boat, or a waterline offset allowing the depth reading to indicate actual water depth.

See page 29 to set a depth offset.

## SETUP WIND - Wind Chapter

### S22 Wind Response



Sets the update period of the Wind display. The options available are: **Auto**/Slow/Medium/Fast

### S23 Wind Angle



Aligns the displayed Apparent Wind Angle with the Actual Wind Direction with respect to the boat.

See page 31 for the calibration process.

### S24 Wind Speed

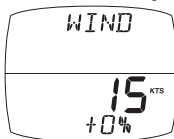

Adds a percentage factor which corrects the information from the Wind Transmitter and ensures the Apparent Wind Speed is displayed correctly.

See page 31 for the calibration process.

### S25 WIND SHIFT

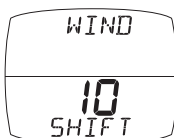

The time period over which the system determines the mean wind direction can be user adjusted in the range 2 to 60 minutes.

## SETUP CMPAS - Compass Chapter

### S26 Heading Response



Sets the update period of the Compass display. Auto/Slow/Medium/Fast

### S27 Heading Format



Tells the display system to show heading information in either Magnetic or True format.

### S28 Compass Heading



Aligns the displayed heading with the Actual Magnetic Heading of the boat.

See page 32 for the calibration process.

### S29 Magnetic Variation



Allows manual entry of local magnetic variation. This setting is ignored if variation information is available from a GPS source.

### S30 Magnetic Deviation

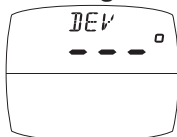

However carefully positioned the Compass Transducer is, there is always the likelihood of errors being introduced by the vessel and equipment. To remove errors it is necessary to "Swing" the compass by turning the boat slowly until the system can optimize the readings. Once the correction has been completed the deviation correction value will be displayed.

See page 32 for the calibration process.

## SETUP OPTS - Options Chapter

### S31 Auto Networking

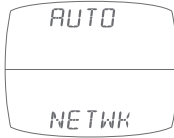

**Only available on the display which was used to power up the system.** Refer to the "Auto Network" sheet for further information.

### S32 Key Lock



Enables the key locking feature.  
See page 8 section 2.5 for the key locking process.

### S33 Page Hiding



Enables the user to hide pages. Refer to page 8, section 2.5. See page 8 section 2.5 for the page hiding process.

### S34 Pages Hidden/Unhide Pages

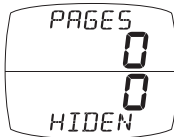

Displays the number of hidden pages. Clears Page Hiding, returning to all pages visible.  
See page 8 section 2.5 for the page unhide process.

### S35 User Defined Chapter



Allows one further selection to be added to the Chapter list (see page 11 -C8).  
The current selection is indicated in the Chapter window.

### S36 Time

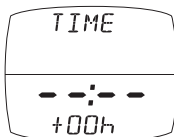

The number of hours added or subtracted from UTC (GMT) to allow the display to show local time.

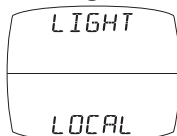
**S37 Light**

Tells the display to control the system Backlighting or just its own Backlighting.  
The options are: Network/Local.

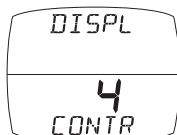
**S38 LCD Contrast**

Allows the contrast of the LCD display to be adjusted to suit the viewing angle of the display. The lower the figure the less contrast is visible.  
The available options are: 1 - 7 default 4.

**S39 Boat Show**

Allows the display to show information when NOT installed as part of a Micronet system for demonstration purposes only.  
Displays will return to default Off on power down.

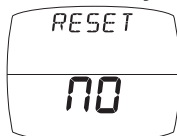
**S40 Factory Reset**

Returns all the calibration setting to the factory default values but does not reset your Auto Networking.  
Only carry out a Reset after consulting with an authorized Tacktick dealer.

## SETUP HELTH - Health Chapter

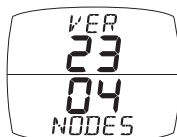
**S41 Software Version/Network Nodes**

The upper window shows the display's Software Version.  
The lower window shows battery level and charge rate, by means of the appropriate icons, to assist in troubleshooting and fault finding.

If the display is the "Master" (the one used to switch on the system) then the number of items (nodes) in the system will be displayed in the lower window. If the display is a "Slave" (was switched on by the system) then the signal strength to the "Master" will be shown.

**S42 Hull Transmitter Signal Strength**

Shows the software version (upper display), signal strength and battery condition (level and charge rate) of the Hull Transmitter to assist in trouble shooting and fault finding.

**S43 Wind Transmitter Signal Strength**

As above but for Wind Transmitter information.

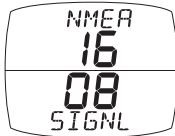
**S44 Wireless (NMEA) Interface Signal Strength**

As above but for Wireless (NMEA) Interface information.

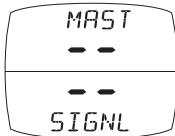
**S45 Mast Angle Sensor Signal Strength**

As above but for Mast Angle sensor information

**S46 MOB Sensor Signal Strength**

As above but for MOB sensor information.

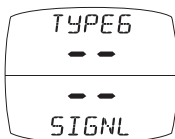
**S47- TYPE 6 to TYPE 9**

Further signal strength indications will be displayed if available.

## 4 Seatrial and Calibration

Once the Micronet display system has been installed on the vessel and Auto Networking has been completed it is necessary to carry out Calibration.



**It is not safe to use the instruments for navigational purposes until Calibration has been carried out correctly.**

### 4.1 Depth Offset

The default depth offset is 0.0 making the display read the Depth below the Transducer. By adding a +ve or -ve offset the display will show the waterline depth or depth below the keel respectively.

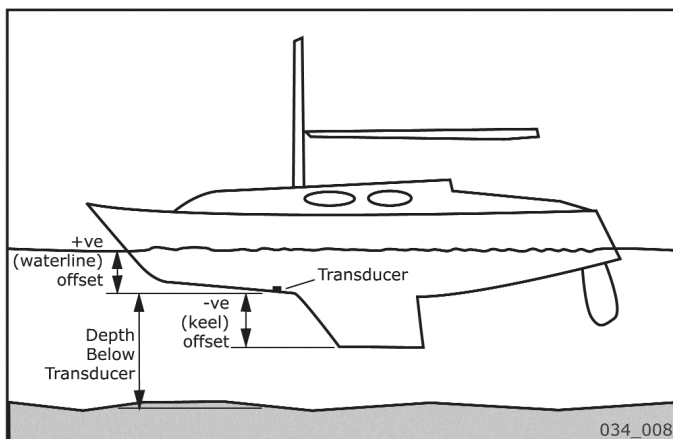

Press and hold the button for 2 seconds to enter Setup  
 Press the button repeatedly to scroll to the **SETUP DEPTH** Chapter

Press the button to advance to the **Keel/Waterline Offset** page

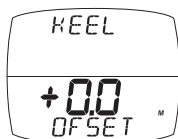

Press the button to enter Edit Mode

Press the and buttons to change the value

Press the button to exit Edit Mode

Press and hold the button to exit Setup and return to normal operation.

## 4.2 Speed Calibration

To ensure that the Boat Speed (and Distance) is accurate it is necessary to calibrate the speed to take into account variations in water flow between different hulls. Adjustment is made by multiplying the Speed through the Water (V) by a percentage Calibration Factor.

It is essential to carry out this procedure at a time where little or no tide is flowing.

### To enter a Log Calibration Factor:

With the vessel under power, steer a straight course allowing the Boat Speed reading to settle to a constant value. Check the GPS is showing a constant SOG.



Press and hold the  button for 2 seconds to enter Setup

Press the  button repeatedly to scroll to the **SETUP SPEED** Chapter

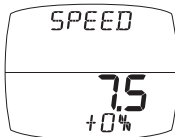
Press the  button to advance to the **Speed Calibration** page



Press the  button to enter Edit Mode

Press the  and  buttons to change the Calibration Factor until the Speed reading displayed matches the GPS SOG reading

Press the  button to exit Edit Mode

Press and hold the  button to exit Setup and return to normal operation.

Should you be unable to carry out this procedure due to strong tidal conditions or poor GPS information there is further information regarding Speed Calibration using a measured distance on the Tacktick website at [www.tacktick.com](http://www.tacktick.com).



## 4.3 Wind Calibration

Both Wind Speed and Direction can be calibrated to ensure that readings from the Wind Transmitter are displayed accurately.

### Wind Angle Offset

Motor the vessel directly into the wind.

Press and hold the  button for 2 seconds to enter Setup

Press the  button repeatedly to scroll to the **SETUP WIND** chapter

Press the  button to advance to the **Wind Angle** page

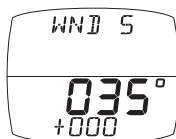

Press the  button to enter Edit Mode

Press the  and  buttons to change the displayed value to 000.

The bottom digits will indicate the number of degrees of offset entered.

Press the  button to exit Edit Mode

Press and hold the  button to exit Setup and return to normal operation.

### Wind Speed Correction

**Note:** Wind Speed reading is factory calibrated to display correctly and should not be altered unless external factors are thought to be causing incorrect readings. Correction should only be carried out if a known correct Wind Speed is available.

Press and hold the  button for 2 seconds to enter Setup

Press the  button repeatedly to scroll to the **SETUP WIND** chapter

Press the  button to advance to the **Wind Speed** page

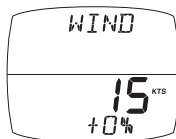

Press the  button to enter Edit Mode

Press the  and  buttons to change the displayed value to the required percentage.



The bottom digits will indicate the displayed wind speed.

Press the  button to exit Edit Mode

Press and hold the  button to exit Setup and return to normal operation.

## 4.4 Compass Calibration and Alignment

To ensure that inaccuracies caused by metallic and magnetic objects on the boat are kept to a minimum is necessary to calibrate the compass. A deviation caused by surrounding objects will be compensated for and the compass reading may be set to the correct heading.

Press and hold the  button for 2 seconds to enter Setup  
Press the  button repeatedly to scroll to the **SETUP COMPAS** Chapter

### To Complete a deviation correction turn:

Press the  button to advance to the **Deviation** Page

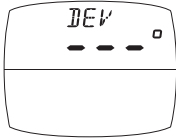

Press the  button to enter Compass Calibration Mode  
Turn the vessel slowly keeping the speed below 4 knots and taking approximately 2 minutes to complete 360 degrees. Keep turning the vessel until the display changes to show a value (usually about 1.25 turns)

**Note:** If the rate of turn of the vessel is too fast the display will show "TURN HIGH". It is not necessary to abandon the turn at this stage but do lessen the rate of turn by reducing speed or widening the turning circle.





Continue to align the heading

Steer the vessel on a known heading.

**Note:** only use the main steering compass as a known heading if you are certain it has been checked and compensated.

Press the  button twice to display the **Heading** page



Press the  button to enter Edit Mode  
Press the  and  buttons to change to the known value. The lower digits will display the offset entered.  
Press the  button to exit Edit Mode  
Press and hold the  button to exit Setup and return to normal operation.

## 5 Installation

### 5.1 Tools list and Parts

**Tools Required** 2.5mm or 5mm Drill Bit (7mm if power connection required)  
 Power Drill  
 Cross Head Screwdriver

**Parts List** Mounting Template  
 Display Backplate and 2x Clip Brackets  
 Mounting Screws (3)  
 Mounting Bolts (3)  
 M4 Studs & Thumbnuts (3)  
 Sealing Gaskets (4)  
 Double Sided Tape

### 5.2 Precautions and Positioning Advice

Ensure mounting surface is flat.  
 Leave space between displays for sun covers.  
 Leave space to remove display from bracket (if used).  
 Avoid areas where damage may occur (winch handles, feet, warps etc.)  
 Select a flat, smooth, surface for mounting and use the template provided to select a suitable position for mounting your Micronet display.  
 Check for clarity of vision and ease of access to the control buttons, it is recommended that displays are positioned such that your arm does NOT pass through the spokes of the steering wheel when operating the buttons.



**Contrast is limited at night when a display is viewed from beneath. Avoid mounting displays in a position where you will look upwards to view them.**

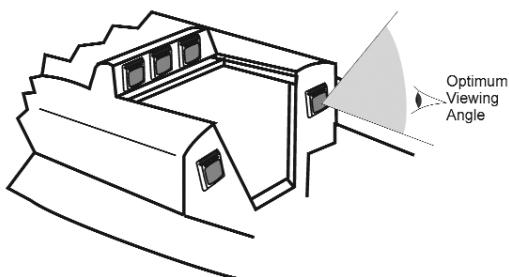

034\_009

### 5.3 Bracket Mounting (Preferred Method)

This method allows for the easy removal of a display as and when required, for either security reasons or to prevent damage or discomfort whilst not in use.

1. Using the three supplied M4 bolts attach the back plate to the rear of the display (Fig.1).
2. Drill three 2.5mm holes marked "A" on the Template and using the supplied self tapping screws, screw the clip bracket to the mounting surface (Fig.2).
3. Place the display flat against the bracket slightly higher than the final position and slide gently down into position. There will be a small click as the bracket secures the display into position (Fig.3).
4. To release the display press lightly on the bracket tab and slide it upwards (Fig.4).

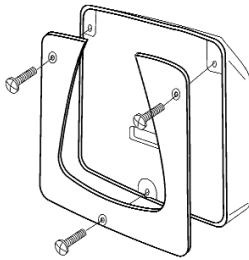

Fig. 1

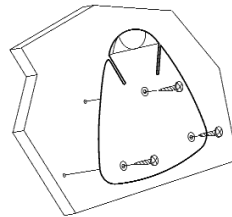

Fig. 2

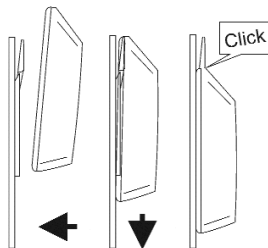

Fig. 3

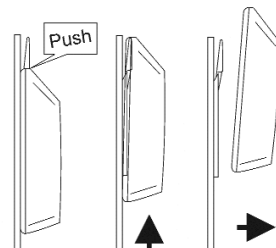

Fig. 4

044-004

## 5.4 Surface Mounting

### Where there is no access to the rear of the mounting surface

Easy installation but will allow removal without gaining access to the boat. Position the supplied Template carefully before starting.

1. Drill three 2.5mm holes marked "B" on the Template.
2. Carefully snap the facia of the display off the main body taking care not to drop the button pads. .  
**HINT** – It may be useful to place a piece of sticky tape across the front of the buttons before removing the facia to prevent them from falling out during the installation.
3. Remove the three captive M4 nuts from the plastic moulding and attach the display to the mounting surface using the three self tapping screws provided. Take care not to over tighten the screws as this may cause the moulding to crack..
4. Check the display is perfectly level, carefully position the button inserts into the correct slots and snap the facia back into position.

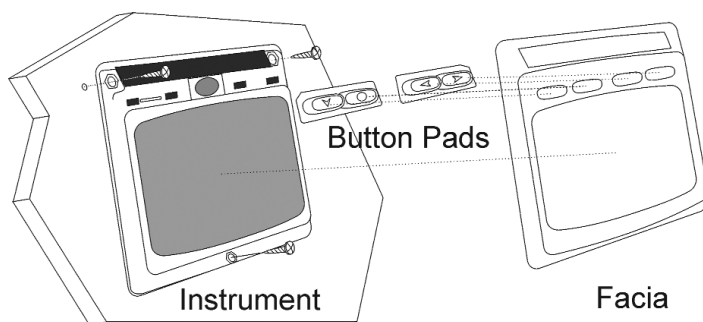

034\_010

### Temporary Mounting

1. Use the double sided tape provided to secure the display to a suitable mounting surface. Press it firmly against the surface until secure.

**Note:** This method is recommended for temporary use only. For example, finding an appropriate location before drilling holes.

## Where access is available to the rear of the mounting surface

This method allows for maximum security of a permanently mounted display. Position the supplied Template carefully before starting.

1. Drill three 5mm holes marked "B" on the Template.
2. Stick the 3 supplied gaskets on the back of the display.
3. Screw the four M4 brass studs into the rear of the display.
4. Place the display in position pushing the three studs through the newly drilled holes.
5. Using the three supplied thumb nuts, secure the display to the surface making sure it is level before final tightening.

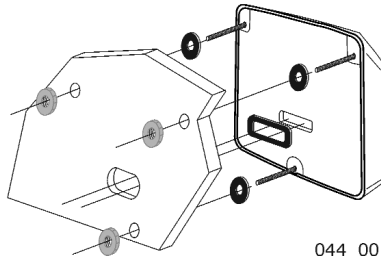

044\_005

## 5.5 External Power Connections

To connect an external 9 to 30V DC power supply to the display head from either a portable battery or the vessel's existing power system.

1. Drill two 7mm holes marked "P" on the Mounting Template and smooth them together with a sharp knife or small file.
2. Pass the supply cable through the new hole and attach the supplied crimp spade receptacles.
3. Remove the blanking plug from the rear of the display to expose the terminals.
4. Stick the supplied gasket on the back of the display.
5. Taking care to connect the correct polarity push the receptacles firmly onto the spades on the rear of the case.
6. Mount the display head securely in position following the steps shown above.
7. Clamp the cable securely close to the display.

## 6 Maintenance and Fault Finding

### 6.1 Care and Maintenance

All Micronet products are totally sealed against water and are not serviceable. Any attempt to take a Micronet product apart will invalidate the warranty.

To clean, use only a damp, soft cloth. No detergents, solvents or abrasives should be used. To avoid damaging a Micronet display unit we recommend storing in the supplied soft pack when not in use.



If the displays are to be stored for a long period of time before next use (Over Winter) ensure that the batteries are fully charged before storage. If necessary connect to a 9 to 30V DC power supply for 24 hrs prior to storage.

### 6.2 Fault Finding and Technical Support

#### Power No Volts Alarm sounds.

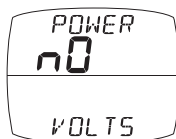

The Hull Transmitter and Wireless (NMEA) Interface must be connected to external power supplies. If this connection is not made, then you will see this alarm 10 seconds after powering up your system. Any DC voltage between 9 and 30V is sufficient to power the Hull Transmitter or Wireless (NMEA) Interface.

#### Power Save Alarm sounds.

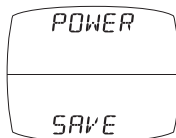

There has been no significant data activity on the network. The alarm sounds to indicate that the display system will turn itself off. To continue using the system press any button to cancel the alarm.

#### Lost Network Alarm sounds.



On a single display this indicates that the particular display has lost communication with the Master\*. Either there is a problem with the Master\* display or the display in question has been moved out of effective range.

On several displays this indicates that these displays have lost communication with the Master\*. Either there is a problem with the master or the Master\* has been moved out of effective range. The displays will power down shortly after sounding the alarm to save power.

**A single display flashes the battery symbol and then switches off.**

The battery level is low on the particular display affected. Connect to a 9 to 30V DC power source or leave in bright sunlight for 12 hours minimum to recharge the display's internal battery. If the particular display is the system Master\* then the other displays will sound the Lost Network Alarm. To continue using the rest of the system power down and restart the system from another display.

**Low Battery Alarm sounds.**

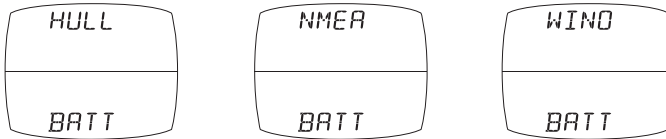

The power level is low in the Hull Transmitter, Wireless (NMEA) Interface or Wind Transmitter. On any Digital Display enter Setup and Calibration mode (Page 18) and scroll through to the Health Chapter. Check the battery levels of the Transmitters and Interface Box. The battery level icon should show 1, 2 or 3 bars to ensure correct operation. Connect the Hull Transmitter or Wireless (NMEA) Interface to a 9 to 30V DC power source for 12 hours minimum to recharge the internal battery. Leave the Wind Transmitter in bright sunlight for 12 hours minimum to recharge its internal battery.

**Data is shown as dashes.**

The information is not being transmitted to the displays. There may be lost communication between the Wind Transmitter or Hull Transmitter and the displays. On any Digital display enter Setup and Calibration mode (page 18) and scroll through to the Health Chapter. Check the signal levels of the Hull and Wind Transmitters. The signal level should show a value of greater than 3 to ensure correct operation.

**Compass Transducer rattles and/or splashes.**

Good! The fluxgate compass is gimballed in a fluid filled container to ensure it is not affected by the boats movement in the water.



**Compass information on the display system does not agree with the main steering compass.**

Ensure that the main steering compass has been swung correctly and is showing correct information. Ensure that the display system has completed correctly the "Swing" procedure described on page 32. If there are still differences, look for magnetic objects (loud speakers, pumps and motors, etc.) close to the Transducer and try mounting the compass transducer in an alternative location. After changing position of nearby equipment or the Compass Transducer it will be necessary to re-swing the compass following the procedure on page 32.

**Boat Speed reads 0.**

Information being transmitted from the Hull Transmitter is being received with a Zero value. Check the paddle wheel for fouling, clean it and make sure it turns easily.

**Wind Speed reads 0.**

Information being transmitted from the Wind Transmitter is being received with a Zero value. If the anemometer cups at the top of the mast are turning and the Wind Speed reads 0 then there is a problem with your Wind Transmitter.

**No NMEA data showing on external displays.**

From any Digital display enter Setup and Calibration Mode (page 18) and scroll through to the Health Chapter. Check the signal level and battery status of the Wireless (NMEA) Interface. If the signal level shows a value of greater than 3 then check the data connections and the settings of the NMEA source equipment to ensure that NMEA 0183 is being transmitted correctly.

**The Depth Alarm does not sound.**

If the actual water depth is shallow and the alarm has not sounded it is most likely that the alarm is switched off. From any Digital display enter Setup and Calibration mode (page 18) and scroll through to the Depth Chapter. Ensure the Depth Alarm settings are correct.

**Note: \*** The "Master Instrument" is the display which was used to power up the entire system. This display may be different each time the system is used. If you are fault finding and are uncertain which display is the master the switch off the system and switch on again. The display which you switched on is now the master.

## 7 Warranty Information

### General

All Tacktick products are designed and built to standards suitable for use in a harsh marine environment. If the products are installed correctly and operated as described in the user guides they will provide long and reliable service. For information and assistance Tacktick operates a network of international distributors.

### Limited Warranty

The warranty covers repair or replacement of parts due to faulty manufacturing and includes labour charges. The warranty period is two years from the date of purchase. Tacktick specifically exclude the implied warranty of merchantability and fitness for a particular purpose.

### Conditions

- A receipt with proof of purchase date must be shown to validate any warranty claim.
- The warranty is extended only to the original purchaser and is non transferable.
- Products that have been incorrectly installed or have serial numbers removed will not be covered.
- No compensation is payable for consequential damage caused directly or indirectly by any malfunction of Tacktick products.
- Tacktick is not liable for any personal damage caused as a consequence of using its equipment.
- Tacktick, its distributors or dealers are not liable for charges arising from sea trials, installation surveys or visits to the boat to attend to the product whether under warranty or not.
- Tacktick reserves the right to replace any products deemed faulty, within the warranty period, with the nearest equivalent.
- The terms and conditions of this warranty do not affect your statutory rights.

### Claims Procedure

Product should be returned to the national distributor, or one of its appointed dealers, in the country where it was originally purchased. Valid claims will then be serviced and returned to the sender free of charge. Distributors reserve the right to charge for exceptional or express carriage if requested.

Alternatively, if the product is being used away from the country of purchase, it may be returned to the national distributor, or one of its approved dealers, in the country where it is being used. In this case valid claims will cover parts only. Labour, handling costs and return shipping will be invoiced to the sender.

## **Disclaimer**

Tacktick products should only be considered an aid to navigation and common sense must be applied at all time when navigating at sea. Tacktick reserves the right to change product specification without notice to comply with its policy of continuous improvement.

This device complies with Part 15 of the FCC rules. Operation is subject to the following two conditions. (1) This device may not cause harmful interference, and (2) this device must accept any interference received, including interference's that may cause undesirable operation.

Tacktick Ltd hereby declare that the mn100 Dual Digital Display is in compliance with the essential requirements and other relevant provisions of Directive 1999/5/EC.

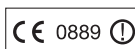



\*UU037 - GB - rev09 1052965\*