

STANDARD HORIZON

EXPLORER GX1600

25 Watt VHF/FM

Marine Transceiver

Owner's Manual

- Ultra slim and compact rear case design (3.5" depth)
 - Meets ITU-R M493-13 Class D DSC (Digital Selective Calling)
 - Oversized full dot matrix display
 - Automatically poll the GPS position of up to 4 ships using DSC
 - Enter, Save, and Navigate to Waypoints with the Compass page*
 - GPS information(LAT/LON, SOG, and COG) information shown on the LCD*
 - Submersible JIS-8 1.5M (4.92Ft) for 30 minutes
 - Noise canceling microphone with channel UP/DOWN, 16/9 and H/L keys
 - NOAA weather channel selection with alert
 - Programmable Scan, Priority Scan, and Dual Watch
 - Programmable soft keys
 - RAM3 Remote Access Microphone capable
 - Intercom between radio and RAM3 microphone
 - NMEA 0183 Input and Output
 - Die-cast chassis
 - E20 (Easy to Operate)
 - 3 Year Waterproof Warranty
- ※ When connected to an optional GPS



TABLE OF CONTENTS









Quick Reference Guide	4	9 DIGITAL SELECTIVE CALLING	34
1 GENERAL INFORMATION	5	9.1 GENERAL	34
2 PACKING LIST	5	9.2 MARITIME MOBILE SERVICE IDENTITY (MMSI)	34
3 OPTIONS	5	9.2.1 What is an MMSI?	34
4 ON-LINE WARRANTY REGISTRATION (in USA or Canada only)	6	9.2.2 Programming the MMSI	35
5 GETTING STARTED	7	9.3 DSC DISTRESS ALERT	36
5.1 PROHIBITED COMMUNICATIONS	7	9.3.1 Transmitting a DSC Distress Alert	36
5.2 ABOUT VHF RADIO	7	9.3.1.1 Transmitting a DSC Distress Alert with Nature of Distress	37
5.3 SELECTING AN ANTENNA	7	9.3.1.2 Transmitting a DSC Distress Alert by Manually Entering a Position	38
5.4 COAXIAL CABLE	8	9.3.1.3 Pausing a DSC Distress Call	39
5.5 EMERGENCY (CHANNEL 16 USE)	8	9.3.2 Receiving a DSC Distress Call	39
5.6 CALLING ANOTHER VESSEL (CHANNEL 16 OR 9)	9	9.3.2.1 a. ACCEPT	39
5.7 MAKING TELEPHONE CALLS	10	9.3.2.1 b. PAUSE	39
5.8 OPERATING ON CHANNELS 13 AND 67	10	9.3.2.1 c. QUIT	39
5.9 AUTOMATED RADIO CHECK SERVICE	10	9.4 ALL SHIPS CALL	41
6 INSTALLATION	12	9.4.1 Transmitting an All Ships Call	41
6.1 SAFETY / WARNING INFORMATION	12	9.4.2 Receiving an All Ships Call	42
6.2 LOCATION	12	9.5 INDIVIDUAL CALL	43
6.3 MOUNTING THE RADIO	13	9.5.1 Individual / Position Call Directory Setup	43
6.3.1 Supplied Mounting Bracket	13	9.5.2 Individual Reply Setup	44
6.3.2 Optional MMB-97 Flush Mount Bracket	13	9.5.3 Individual Acknowledgment Setup	44
6.4 ELECTRICAL CONNECTIONS	14	9.5.4 Individual / Group Call Ringer Setup	45
6.5 ACCESSORY CABLE	15	9.5.5 Transmitting an Individual Call	46
6.6 CHECKING GPS CONNECTIONS	16	9.5.5.1 Individual Call using the Individual Directory	46
6.7 CHANGING THE GPS TIME	16	9.5.5.2 Individual Call by Manually Entering a MMSI	47
6.8 CHANGING THE TIME AREA	17	9.5.6 Receiving an Individual Call	48
6.9 CHANGING THE TIME DISPLAY	17	9.6 DSC LOG OPERATION	49
6.10 CHANGING COG TO TRUE OR MAGNETIC	18	9.6.1 Reviewing and Resending a Logged Transmitted Call	49
6.11 OPTIONAL RAM3 (CMP30) INSTALLATION	18	9.6.2 Reviewing a Logged DSC Distress Call	49
6.11.1 Connecting an External Speaker to the RAM3 Mic Cable	20	9.6.3 Reviewing a Logged Other Calls	50
6.11.2 External Speaker AF Selection	20	9.6.4 Deleting a Call from the "DSC LOG" Directory	50
7 CONTROLS AND INDICATORS	22	9.7 GROUP CALL	52
7.1 FRONT PANEL	22	9.7.1 Group Call Setup	52
7.2 REAR PANEL	24	9.7.2 Transmitting a Group Call	53
7.3 MICROPHONE	25	9.7.2.1 Group Call using the Individual Directory	53
8 BASIC OPERATION	26	9.7.2.2 Group Call by Manually Entering a MMSI	54
8.1 RECEPTION	26	9.7.3 Receiving a Group Call	55
8.2 TRANSMISSION	26	9.8 POSITION REQUEST	56
8.3 TRANSMIT TIME-OUT TIMER (TOT)	26	9.8.1 Position Reply Setup	56
8.4 SIMPLEX/DUPLEX CHANNEL USE	27	9.8.2 Position Request Ringer Setup	57
8.5 DISPLAY TYPE	27	9.8.3 Transmitting a Position Request to Another Vessel	57
8.6 USA, CANADA, AND INTERNATIONAL MODE	28	9.8.3.1 Position Request using the Individual Directory	57
8.7 NOAA WEATHER CHANNELS	28	9.8.3.2 Position Request by Manually Entering a MMSI	58
8.7.1 NOAA Weather Alert	28	9.8.4 Receiving a Position Request	59
8.7.2 NOAA Weather Testing	29	9.9 POSITION REPORT	60
8.8 DUAL WATCH (TO CHANNEL16)	29	9.9.1 Position Report Ringer Setup	60
8.9 SCANNING	30	9.9.2 Transmitting a DSC Position Report Call	60
8.9.1 Scan Type Selection	30	9.9.2.1 DSC Position Report Call using the Individual Directory	60
8.9.2 Scan Memory Programming	30	9.9.2.2 DSC Position Report Call by Manually Entering a MMSI	61
8.9.3 Memory Scanning (M-SCAN)	31	9.9.3 Receiving a DSC Position Report Call	62
8.9.4 Priority Scanning (P-SCAN)	31	9.9.4 Navigating to a Position Report	62
8.10 PRESET CHANNELS (0-9): INSTANT ACCESS	32	9.9.5 Stop Navigating to Position Report	62
8.10.1 Preset Channel Programming	32	9.9.6 Saving a Position Report Call as a Waypoint	63
8.10.2 Operation	32	9.9.7 Navigating to a Saved Waypoint	63
8.10.3 Deleting a Preset Channel	32	9.10 MANUAL INPUTTING A GPS POSITION (LAT/LON)	64
8.11 INTERCOM OPERATION	33	9.11 AUTO POS POLLING	65
8.11.1 Communication	33	9.11.1 Polling Time Interval Setup	65
8.11.2 Calling	33	9.11.2 Selecting Stations to be Automatically Polled (tracked)	65
		9.11.3 Enable/Disable Auto POS Polling	66
		9.12 DSC TEST	67
		9.12.1 Programming MMSI into Individual Directory	67
		9.12.2 DSC Test Call by using Individual Directory	67
		9.12.3 DSC Test Call by Manually Entering MMSI	68

TABLE OF CONTENTS

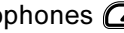
10 GENERAL SETUP	69	13 WAYPOINTS	85
10.1 DISPLAY	69	13.1 MARKING A POSITION	85
10.2 DIMMER ADJUSTING	70	13.2 ADDING A WAYPOINT	86
10.3 CONTRAST	70	13.3 EDITING A WAYPOINT	87
10.4 TIME OFFSET	71	13.4 DELETING A WAYPOINT	87
10.5 TIME AREA	72	13.5 SAVING A DSC POSITION CALL AS A WAYPOINT	88
10.6 TIME DISPLAY	72	13.6 NAVIGATING TO A SAVED WAYPOINT	88
10.7 UNIT OF MEASURE	73	13.7 STOP NAVIGATING TO A WAYPOINT	89
10.8 MAGNETIC	74	14 RAM3 (CMP30) REMOTE MIC OPERATION	90
10.9 KEY BEEP	74	14.1 REMOTE MIC CONTROLS	90
10.10 STATION NAME	75	14.2 ASSIGNING SOFT KEYS	92
10.11 SOFT KEYS	76	15 MAINTENANCE	94
10.11.1 Selecting the Number of Soft Keys	76	15.1 REPLACEMENT PARTS	94
10.11.2 Assigning Soft Keys	76	15.2 FACTORY SERVICE	94
10.11.3 Selecting How Long the Soft Keys are Shown	77	15.3 TROUBLESHOOTING CHART	95
11 CHANNEL FUNCTION SETUP	78	16 CHANNEL ASSIGNMENTS	96
11.1 CHANNEL GROUP	78	17 WARRANTY	102
(USA, CANADA or INTERNATIONAL BAND SELECTION)	78	18 RESET PROCEDURES	105
11.2 SCAN MEMORY	78	18.1 MEMORY CLEAR	105
11.3 SCAN TYPE	79	18.2 MICROPROCESSOR RESETTING	105
11.4 SCAN RESUME	79	19 SPECIFICATIONS	106
11.5 PRIORITY CHANNEL	80	19.1 GENERAL	106
11.6 WEATHER ALERT	80	19.2 TRANSMITTER	106
11.7 CHANNEL NAME	81	19.3 RECEIVER	107
12 DSC SETUP	82	19.4 NMEA INPUT/OUTPUT	107
12.1 INDIVIDUAL DIRECTORY	82	19.5 DIMENSIONS	108
12.2 INDIVIDUAL REPLY	82	20 FCC RADIO LICENSE INFORMATION	110
12.3 INDIVIDUAL ACKNOWLEDGMENT	82	20.1 STATION LICENSE	110
12.4 INDIVIDUAL RINGER	82	20.2 RADIO CALL SIGN	110
12.5 GROUP DIRECTORY	82	20.3 CANADIAN SHIP STATION LICENSING	110
12.6 POSITION REPLY	83	20.4 FCC/INDUSTRY CANADA INFORMATION	110
12.7 AUTO POSITION INTERVAL	83	21 FCC NOTICE	111
12.8 DSC BEEP	83		
12.9 AUTO CHANNEL SWITCH TIME	84		



QUICK REFERENCE GUIDE

This transceiver is equipped with the E2O (Easy-To-Operate) system. You can do the basic operation in numerical order of the illustration below.

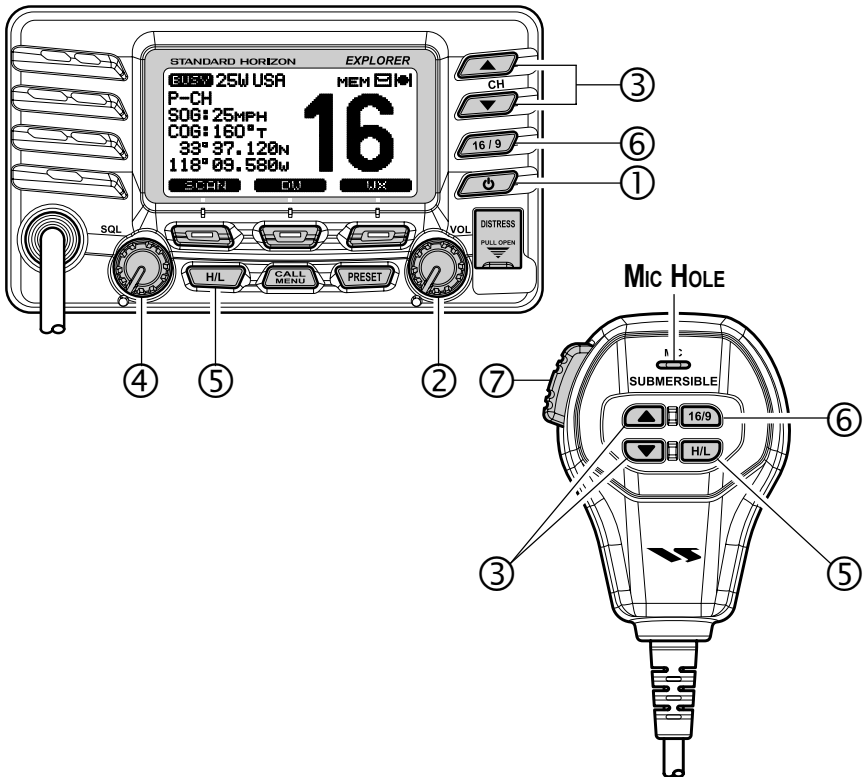
- ① Press and hold the  button to turn on or off the radio.
- ② Rotate the **VOL** knob to adjust the speaker audio volume.
- ③ Press the  (or microphones ) button to select the operating channel.
- ④ Move the **SQL** knob clockwise to squelch or counter clockwise un-squelch the radio.
- ⑤ Press the  (or microphones ) button to toggle the transmit power between High (25W) and Low (1W).
- ⑥ Press the  (or microphones ) button to recall channel 16. Press and hold the  (or microphones ) button to recall channel 9. Press again to revert to the last selected channel.
- ⑦ Place your mouth about 1/2 inch away from Mic hole and speak in a normal voice level while pressing the **PTT** switch.



1 GENERAL INFORMATION

The STANDARD HORIZON **EXPLOPER GX1600** Marine VHF/FM Marine transceiver is capable of ITU-R 493-13 DSC (Digital Selective Calling) Class D operation. Class D operation allows continuous receiving of Digital Selective Calling functions on channel 70 even if the radio is receiving a call. The **GX1600** VHF operate on all currently-allocated marine channels which are switchable for use with USA, International, or Canadian regulations. Emergency channel 16 can be immediately selected from any channel by pressing the red  key. NOAA Weather channels can also be accessed immediately by pressing the  soft key.

The **GX1600** can be operated from 11 to 16 VDC and has a switchable RF output power of 1 watt or 25 watts.

Other features of the **GX1600** VHF's include: Slim design only 3.5" deep, Noise canceling microphone with controls, optional **RAM3** second station remote-control microphone with display, intercom between radio and optional **RAM3**, scanning, priority scanning, Dual Watch, DSC Position Polling up to 4 vessels, high and low voltage warning, and GPS repeatability.

2 PACKING LIST

When the package containing the transceiver is first opened, please check it for the following contents:

- **GX1600** Transceiver
- Mounting Bracket and hardware
- Owner's Manual
- DSC Warning Sticker
- Flush Mount Template
- Power Cord

3 OPTIONS

HC1600	Dust Cover (White)
MMB-97	Flush-Mount Bracket
CMP30B/W	Remote-Access Microphone (RAM3 Mic, Black/White)
CT-100	23-foot Extension Cable for RAM3 Mic
MLS-310	10W amplified External Speaker with on/off Volume control
MLS-300	External Loud Speaker

4 ON-LINE WARRANTY REGISTRATION (in USA or Canada only)

Please visit www.standardhorizon.com to register the **GX1600** Marine VHF. It should be noted that visiting the Web site from time to time may be beneficial to you, as new products are released they will appear on the STANDARD HORIZON Web site.

PRODUCT SUPPORT INQUIRIES

If you have any questions or comments regarding the use of the **GX1600**, you can visit the Marine Division of Vertex Standard Web site to send an E-Mail or contact the Product Support team at (800) 767-2450 M-F 7:00AM to 5:00PM PST.

5 GETTING STARTED

5.1 PROHIBITED COMMUNICATIONS

The FCC prohibits the following communications:

- False distress or emergency messages;
- Messages to “any boat” except in emergencies and radio tests;
- Messages to or from a vessel on land;
- Transmission while on land;
- Obscene, indecent, or profane language (potential fine of \$10,000).

5.2 ABOUT VHF RADIO

The radio frequencies used in the VHF marine band lie between 156 and 158 MHz with some shore stations available between 161 and 163 MHz. The marine VHF band provides communications over distances that are essentially “line of sight” (VHF signals do not travel well through objects such as buildings, hills or trees). Actual transmission range depends much more on antenna type, gain and height than on the power output of the transmitter. On a fixed mount 25W radio transmission expected distances can be greater than 15 miles, for a portable 5W radio transmission the expected distance can be greater than 5 miles in “line of sight”.

5.3 SELECTING AN ANTENNA

Marine antennas are made to radiate signals equally in all horizontal directions, but not straight up. The objective of a marine antenna is to enhance the signal toward the horizon. The degree to which this is accomplished is called the antenna’s gain. It is measured in decibels (dB) and is one of the major factors in choosing an antenna. In terms of effective radiated power (ERP), antennas are rated on the basis of how much gain they have over a theoretical antenna with zero gain. A 3 foot, 3dB gain antenna represents twice as much gain over the imaginary antenna.

Typically a 3 foot 3dB gain stainless steel whip is used on a sailboat mast. The longer 8 foot 6dB fiberglass whip is primarily used on power boats that require the additional gain.

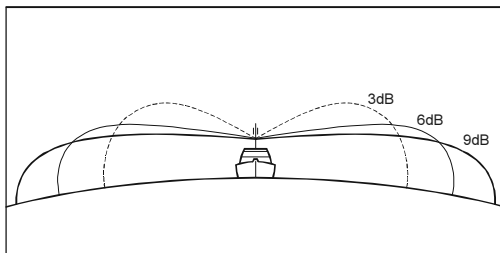

5.4 COAXIAL CABLE

VHF antennas are connected to the transceiver by means of a coaxial cable – a shielded transmission line. Coaxial cable is specified by its diameter and construction.

For runs less than 20 feet, RG-58/U, about 1/4 inch in diameter is a good choice. For runs over 20 feet but less than 50 feet, the larger RG-8X or RG-213/U should be used for cable runs over 50 feet RG-8X should be used. For installation of the connector onto the coaxial cable refer to the figure below.

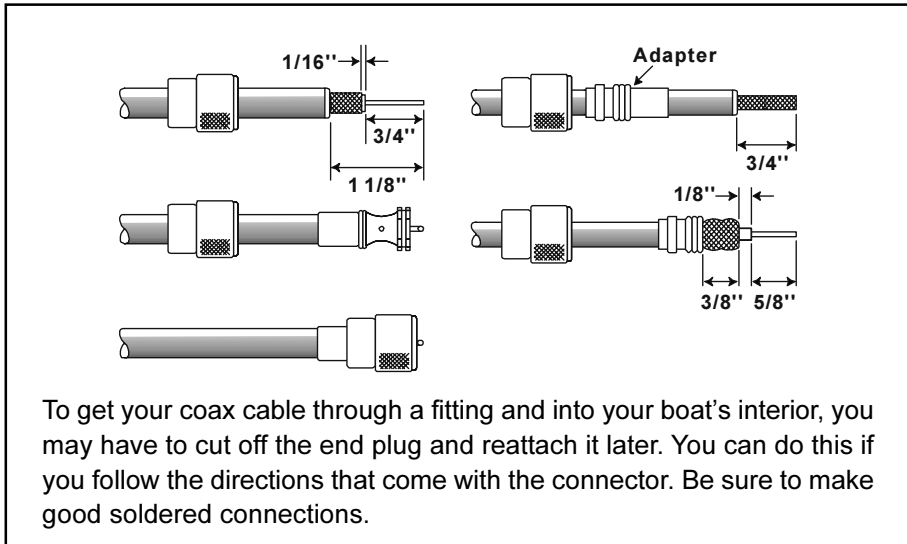

5.5 EMERGENCY (CHANNEL 16 USE)

Channel 16 is known as the Hail and Distress Channel. An emergency may be defined as a threat to life or property. In such instances, be sure the transceiver is on and set to CHANNEL 16. Then use the following procedure:

1. Press the microphone push-to-talk switch and say "**Mayday, Mayday, Mayday**. This is _____, _____, _____" (your vessel's name).
2. Then repeat once: "**Mayday**, _____" (your vessel's name).
3. Now report your position in latitude/longitude, or by giving a true or magnetic bearing (state which) to a well-known landmark such as a navigation aid or geographic feature such as an island or harbor entry.
4. Explain the nature of your distress (sinking, collision, aground, fire, heart attack, life-threatening injury, etc.).
5. State the kind of assistance your desire (pumps, medical aid, etc.).
6. Report the number of persons aboard and condition of any injured.

7. Estimate the present seaworthiness and condition of your vessel.
8. Give your vessel's description: length, design (power or sail), color and other distinguishing marks. The total transmission should not exceed 1 minute.
9. End the message by saying "**OVER**". Release the microphone button and listen.
10. If there is no answer, repeat the above procedure. If there is still no response, try another channel.

NOTE

The **GX1600** have DSC Distress calling, that can transmit a distress call digitally to all ships with compatible DSC radios. Refer to section "**9 DIGITAL SELECTIVE CALLING**".

5.6 CALLING ANOTHER VESSEL (CHANNEL 16 OR 9)

Channel 16 may be used for initial contact (hailing) with another vessel. However, its most important use is for emergency messages. This channel must be monitored at all times except when actually using another channel.

It is monitored by the U.S. and Canadian Coast Guards and by other vessels.

Use of channel 16 for hailing must be limited to initial contact only. Calling should not exceed 30 seconds, but may be repeated 3 times at 2-minute intervals. In areas of heavy radio traffic, congestion on channel 16 resulting from its use as a hailing channel can be reduced significantly in U.S. waters by using **channel 9** as the initial contact (hailing) channel for non-emergency communications. Also hailing on channel 9, the calling time should not exceed 30 seconds but may be repeated 3 times at 2-minute intervals.

Prior to making contact with another vessel, refer to the channel charts in this manual, and select an appropriate channel for communications after initial contact. For example, Channels 68 and 69 of the U.S. VHF Charts are some of the channels available to non-commercial (recreational) boaters. Monitor your desired channel in advance to make sure you will not be interrupting other traffic, and then go back to either channel 16 or 9 for your initial contact.

When the hailing channel (16 or 9) is clear, press the **PTT** button on the mic and state the name of the other vessel you wish to call and then "**this is**" followed by the name of your vessel and your Station License (Call Sign) then release the **PTT** button on the mic. When the other vessel returns your call, immediately request another channel by pressing the **PTT** button on the mic and saying "**go to**," the number of the other channel, say "over" and release the **PTT** button on the mic. Then switch to the new channel. When the new channel is not busy, call the other vessel.

After a transmission, say “**over**,” and release the microphone’s push-to-talk (PTT) switch. When all communication with the other vessel is completed, end the last transmission by stating your Call Sign and the word “**out**.” Note that it is not necessary to state your Call Sign with each transmission, only at the beginning and end of the contact.

Remember to return to Channel 16 when not using another channel. Some radios automatically monitor Channel 16 even when set to other channels or when scanning.

5.7 MAKING TELEPHONE CALLS

To make a radiotelephone call, use a channel designated for this purpose, The fastest way to learn which channels are used for radiotelephone traffic is to ask at a local marina. Channels available for such traffic are designated **Public Correspondence** channels on the channel charts in this manual. Some examples for USA use are Channels 24, 25, 26, 27, 28, 84, 85, 86, and 87. Call the marine operator and identify yourself by your vessel’s name, The marine operator will then ask you how you will pay for the call (telephone credit card, collect, etc.) and then link your radio transmission to the telephone lines.

The marine telephone company managing the VHF channel you are using may charge a link-up fee in addition to the cost of the call.

5.8 OPERATING ON CHANNELS 13 AND 67

Channel 13 is used at docks and bridges and by vessels maneuvering in port. Messages on this channel must concern navigation only, such as meeting and passing in restricted waters.

Channel 67 is used for navigational traffic between vessels.

By regulation, power is normally limited to 1 Watt on these channels. Your radio is programmed to automatically reduce power to this limit on these channels. However, in certain situations it may be necessary to temporarily use a higher power. See page 23 ( key) for means to temporarily override the low-power limit on these two channels.

5.9 AUTOMATED RADIO CHECK SERVICE

In areas across the country, Sea Tow offers boaters a way to conduct radio checks. To use Sea Tow’s free Automated Radio Check service, simply tune your VHF radio to the appropriate channel for your location and conduct a radio check as you typically would. Upon releasing your radio’s microphone, the system will play an automated message and relay your transmission back to you, thereby letting you know how your signal will sound to other boaters.

The Automated Radio Check Service is currently available in the areas listed below.

West Coast

Sea Tow Newport/LA - Ch. 27

Sea Tow San Diego - Ch. 27

Northeast

Sea Tow Portland-Midcoast (Maine) - Ch. 27

Sea Tow Boston - Ch. 27

Sea Tow South Shore (Mass.) - Ch. 28

Sea Tow Rhode Island - Ch. 24

Sea Tow Eastern Long Island - Ch. 27

Sea Tow Huntington (N.Y.) - Ch. 27

Sea Tow Manasquan (N.J.) - Ch. 28

Mid-Atlantic

Sea Tow Northern Chesapeake (Md.) - Ch. 28

Sea Tow Central Chesapeake (Md.) - Ch. 27

Sea Tow Hampton Roads (Va.) - Ch. 28

North Carolina

Sea Tow Wrightsville Beach - Ch. 28

Sea Tow Ocean Isle Beach - Ch. 28

Florida

Sea Tow Sebastian - Ch. 28

Sea Tow Fort Lauderdale - Ch. 27

Sea Tow Charlotte Harbor - Ch. 24

Sea Tow Tampa Bay - Ch. 27

Sea Tow Horseshoe Beach - Ch. 27

Sea Tow Carrabelle/St. Marks - Ch. 27

Sea Tow Pensacola/Orange Beach (Ala.) - Ch. 27

6 INSTALLATION

6.1 SAFETY / WARNING INFORMATION

This radio is restricted to occupational use, work related operations only where the radio operator must have the knowledge to control the exposure conditions of its passengers and bystanders by maintaining the minimum separation distance of 0.89 m (2.92 feet). Failure to observe these restrictions will result in exceeding the FCC RF exposure limits.

Antenna Installation:

The antenna must be located at least 0.89 m (about 3 feet) away from passengers in order to comply with the FCC RF exposure requirements.

6.2 LOCATION

The radio can be mounted at any angle. Choose a mounting location that:

- is far enough from any compass to avoid any deviation in compass reading due to the speaker magnet
- provides accessibility to the front panel controls
- allows connection to a power source and an antenna
- has nearby space for installation of a microphone hanger
- choose a mounting location that is at least 3 feet (1 m) away from the radio's antenna.

Note: To insure the radio does not affect the compass or radios performance is not affected by the antenna location, temporarily connect the radio in the desired location and:

- a. Examine the compass to see if the radio causes any deviation
- b. Connect the antenna and key the radio. Check to ensure the radio is operating correctly by requesting a radio check.

6.3 MOUNTING THE RADIO

6.3.1 Supplied Mounting Bracket

The supplied mounting bracket allows overhead or desktop mounting.

Use a 13/64" (5.2 mm) bit to drill the holes to a surface which is more 0.4 inch (10 mm) thick and can support more than 3.3 lbs (1.5 kg) and secure the bracket with the supplied screws, spring washers, flat washers, and nuts.

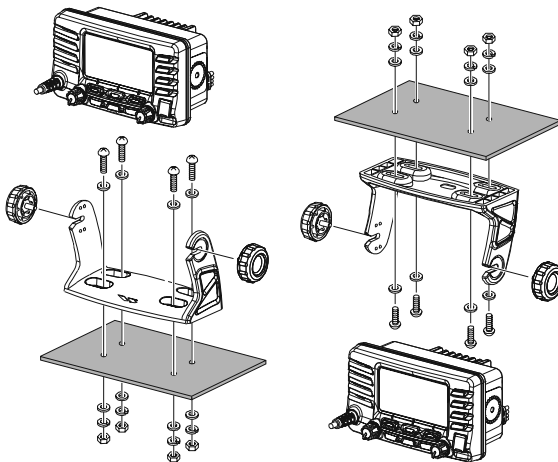

DESKTOP MOUNTING

OVERHEAD MOUNTING

6.3.2 Optional MMB-97 Flush Mount Bracket

1. Use the supplied template to mark the location where the rectangular hole is to be cut. Confirm the space behind the dash or panel is deep enough to accommodate the transceiver (at least 3.54 inches (90 mm) deep). There should be at least 1/2 inch (1.3 cm) between the transceiver's heatsink and any wiring, cables or structures.
2. Cut out the rectangular hole 2.82" H x 5.39" W (72 x 137 mm) and insert the transceiver.
3. Fasten the brackets to the rear panel of the transceiver (see illustration below).
4. Turn the adjusting screw to adjust the tension so that the transceiver is tight against the mounting surface.

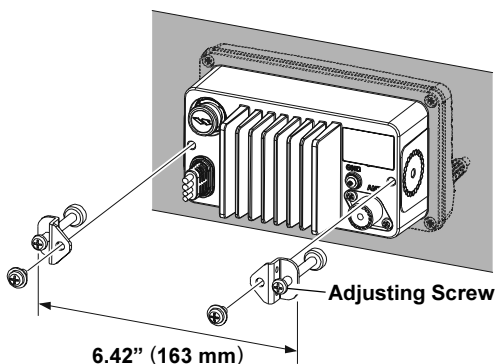

6.4 ELECTRICAL CONNECTIONS

CAUTION

Reverse polarity battery connections will damage the radio!

Connect the power cord and antenna to the radio. Antenna and Power Supply connections are as follows:

1. Mount the antenna at least 3 feet (1 m) away from the radio. At the rear of the radio, connect the antenna cable. The antenna cable must have a PL259 connector attached. RG-8/U coaxial cable must be used if the antenna is 25 feet (7.6 m) or more from the radio. RG58 cable can be used for distances less than 25 feet (7.6 m).
2. Connect the red power wire to a 11.0 V to 16.5 V DC power source (Normal: 13.8 VDC). Connect the black power wire to a negative ground.
3. If an optional remote extension speaker is to be used, refer to section “**6.5 ACCESSORY CABLE**” for connections.
4. It is advisable to have a Certified Marine Technician check the power output and the standing wave ratio of the antenna after installation.

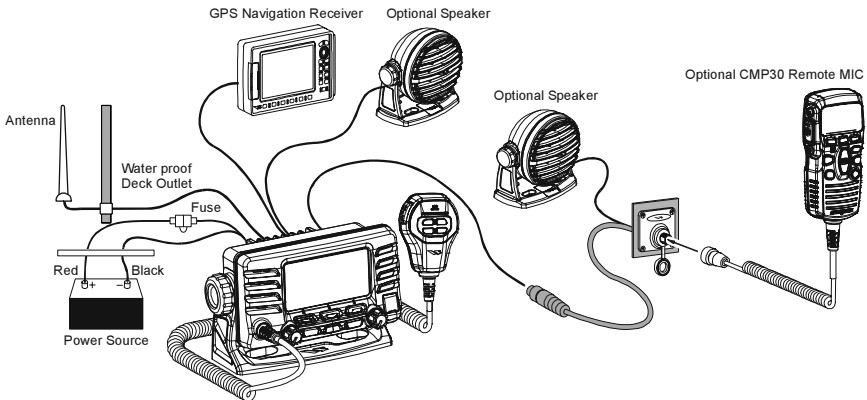

Fuse Replacement (125V 6A)

To take out the Fuse from the Fuse Holder, hold both ends of the Fuse Holder and pull the Fuse Holder apart without bending the Fuse Holder. When you replace the Fuse, please confirm that the Fuse is tightly fixed on the metal contact located inside the Fuse Holder. If the metal contact holding the fuse is loose, the Fuse holder may heat up.

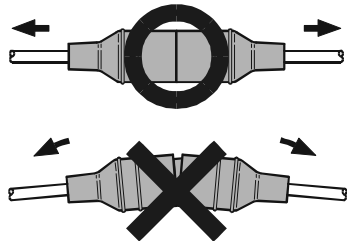

6.5 ACCESSORY CABLE

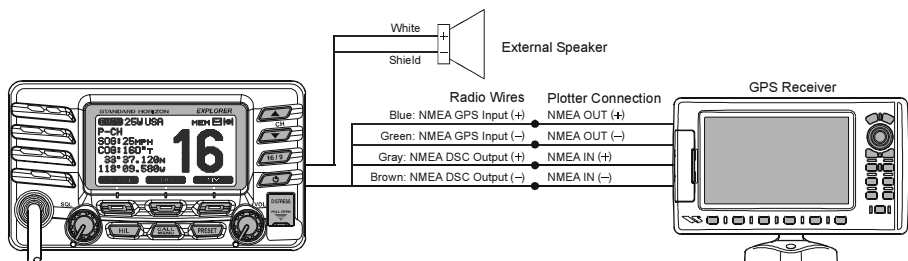

Wire Color/Description	Connection Examples
WHITE - External Speaker (+)	Connect to external 4 Ohm audio speaker
SHIELD - External Speaker (-)	Connect to external 4 Ohm audio speaker
BLUE - NMEA GPS Input (+)	Connect to NMEA (+) output of GPS
GREEN - NMEA GPS Input (-)*	Connect to NMEA (-) output or common ground of GPS
GRAY - NMEA DSC Output (+)	Connect to NMEA (+) input of GPS
BROWN - NMEA GPS Output (-)*	Connect to NMEA (-) input or common ground of GPS

※: Some GPS Chart plotters have a single wire for NMEA Signal Ground, if this is the case connect the NMEA Input (-) and NMEA output (-) to the GPS Chart Plotters single NMEA Signal Ground wire.

When connecting the external speaker or GPS navigation receiver, strip off about 1 inch (2.5 cm) of the specified wire's insulation, then splice the ends together.

GPS Connections (4800 baud)

NMEA INPUT (GPS Information)

- The GPS must have the NMEA Output turned on and set to 4800 Baud in the setup menu. If there is a selection for parity select none.
- For further information on interfacing /setting up your GPS. Please contact the manufacturer of the GPS receiver.
- **GX1600** can read NMEA-0183 version 2.0 or higher.
- The NMEA 0183 input sentences are GLL, GGA, RMC and GNS (RMC sentence is recommended).

NMEA Output (DSC)

The NMEA 0183 output sentences are DSC and DSE.

If you have further inquiries, please feel free to contact Product Support at:

Phone: (800) 767-2450

Email: marinetech@vxstdusa.com

6.6 CHECKING GPS CONNECTIONS

After connections have been made between the **GX1600** and the GPS, a small satellite icon will appear on the top right corner of the display and your current location (Latitude/Longitude) is shown on the display.

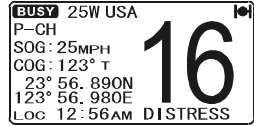

NOTE

If there is a problem with the NMEA connection between the radio and the GPS, the GPS icon will blink continuously until the connection is corrected.

6.7 CHANGING THE GPS TIME

From the Factory the **GX1600** shows GPS satellite time or UTC time when an optional GPS is connected. A time offset is needed to show the local time in your area. The Time Offset must be changed in order for the radio to display the current time in your area. Please see the Offset Time Table at the bottom of this page.



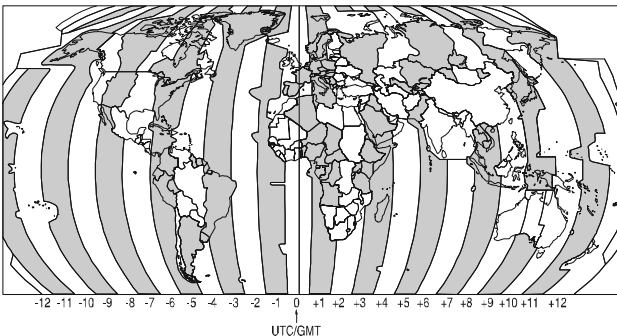
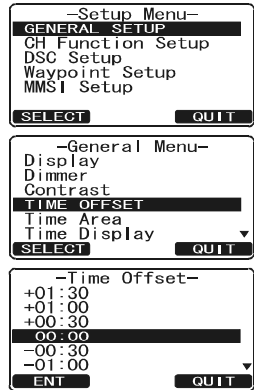

1. Press and hold down the **CALL CALL** key until "Setup Menu" appears, then select "GENERAL SETUP" with the **▲/▼** key.
2. Press the **SELECT** soft key, then select "TIME OFFSET" with the **▲/▼** key.
3. Press the **SELECT** soft key, then press the **▲/▼** key to select time offset of your location. See illustration below to find your offset time. If "00:00" is assigned, the time is the same as UTC (Universal Time Coordinated or GPS Satellite Time).
4. Press the **ENT** soft key to store the time offset.
5. Press the **QUIT** soft key several times to return to radio operation.



TIME OFFSET TABLE

6.8 CHANGING THE TIME AREA



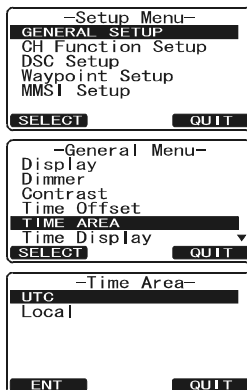

This menu selection allows the radio to show UTC time or local time with the offset.

1. Press and hold down the  key until "Setup Menu" appears, then select "GENERAL SETUP" with the  key.
2. Press the **SELECT** soft key, then press the  key to "TIME AREA".
3. Press the **SELECT** soft key.
4. Press the  key to select "UTC" or "LOCAL".
5. Press the **ENT** soft key to store the selected setting.
6. Press the **QUIT** soft key several times to return to radio operation.



6.9 CHANGING THE TIME DISPLAY



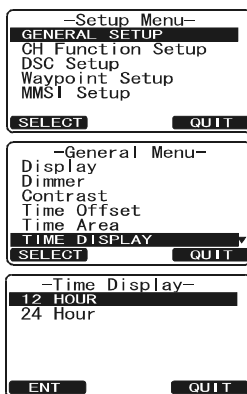

This menu selection allows the radio to setup to show time in 12-hour or 24-hour format.

1. Press and hold down the  key until "Setup Menu" appears, then select "GENERAL SETUP" with the  key.
2. Press the **SELECT** soft key, then press the  key to select "TIME DISPLAY".
3. Press the **SELECT** soft key.
4. Press the  key to select "12 HOUR" or "24 HOUR".
5. Press the **ENT** soft key to store the selected setting.
6. Press the **QUIT** soft key several times to return to radio operation.



6.10 CHANGING COG TO TRUE OR MAGNETIC

Allows the GPS Course Over Ground to be selected to show in True or Magnetic. Factory default is True however by following the steps below the COG can be changed to Magnetic.

1. Press and hold down the  key until "Setup Menu" appears, then select "GENERAL SETUP" with the  key.
2. Press the **SELECT** soft key, then press the  key to select "MAGNETIC".
3. Press the **SELECT** soft key.
4. Press the  key to select "MAGNETIC" or "TRUE".
5. Press the **ENT** soft key to store the selected setting.
6. Press the **QUIT** soft key several times to return to radio operation.

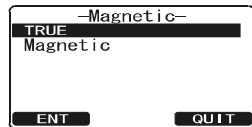
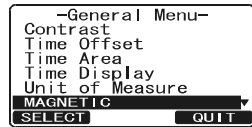
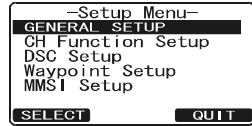

6.11 OPTIONAL RAM3 (CMP30) INSTALLATION

The **GX1600** is capable of using a **RAM3 (CMP30)** Remote Station Microphone to remotely control the Radio and DSC functions. In addition the **GX1600** can operate as a full function intercom system between the **RAM3** and the radio.

1. Connect the Extension Cable to the Remote Mic eight pin connector on the rear panel, then tighten the Cable Nut (see illustration at the right).
2. Install the ferrite core (supplied with the **RAM3 (CMP30)** Remote Station Microphone) to the Extension Cable, then snap its two halves together, per the illustration below.
3. Attach the ferrite core as close as possible to the MIC plug, as shown.
4. Finally, wind some plastic tape around each ferrite core, to prevent vibration from causing the two halves to split apart.

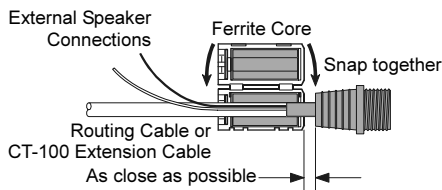
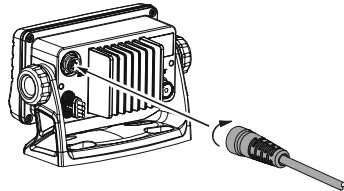

5. Referring to illustration below, make a 1.2" (30 mm) hole in the wall, then insert the Extension Cable into this hole. Connect the Gasket and Mount Base to the Extension Cable Connector using the Nut.
6. Drill the four Screw holes (approx. 2 mm) on the wall, then install the Mounting Base to the wall using four screws.
7. Put the Rubber Cap on to the Nut. The installation is now complete.

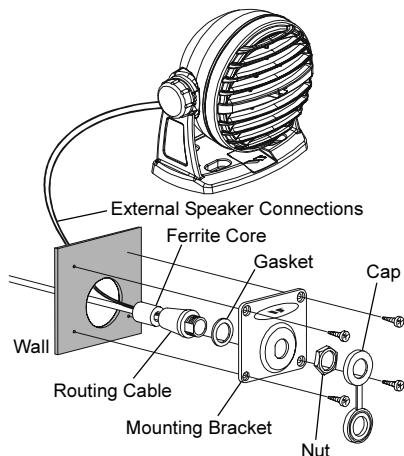











NOTE

The routing cable can be cut and spliced, however care needs to be taken when reconnecting the wires to ensure water integrity. Before cutting the cable make sure it is not plugged into the radio. After cutting you will notice there are the following wires:
Brown, Purple, Blue, Green, White*, Shield*
* The White and shield wires are wrapped in foil. Remove the foil, and separate the White and shield wires.

6.11.1 Connecting an External Speaker to the RAM3 Mic Cable





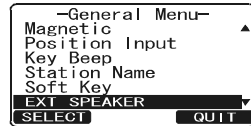
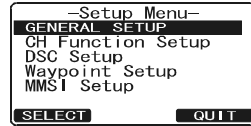





In noisy locations and optional external speaker may be connected to the white speaker wires on the **RAM3** routing cable. The **RAM3** can drive the internal speaker or the external speaker one at a time. When connecting an external speaker, follow the procedure below to turn off the **RAM3** audio and enable the external speaker wires on the **RAM3** routing cable.

1. On the RAM3 mic, press and hold the  key until “Setup Menu” appears, then select “GENERAL SETUP” with the  /  key.
2. Press the  soft key.
3. Press the  key to until “EXT SPEAKER” is shown and press the  soft key.
4. Press the  or  key to select “OFF” (External speaker off) or “ON” (External speaker on).
5. Press the  soft key to save the selection.
6. Press the  key to exit this mode.



6.11.2 External Speaker AF Selection

The “AF Select” menu allows you to set the audio output level of the **RAM3** external speaker wires (on routing cable) to a fixed level regardless of the volume level setting of the **RAM3**. This is useful when using the optional **MLS-310** amplified speaker with on/off volume control.

1. On the RAM3 mic, press and hold the  key until “Setup Menu” appears, then select “GENERAL SETUP” with the  /  key.
2. Press the  soft key.
3. Press the  key to until “AF SELECT” is shown and press the  soft key.
4. Press the  or  key to select “PRE-OUT” (External Speaker Level is “Fixed”) or “PA-OUT” (External Speaker Level is “Adjustable”).
“Fixed” use when **MLS-310** is connected.
“Adjustable” use when **MLS-300** or other speaker without volume control is connected.
5. Press the  key to save the selection.
6. Press the  key to exit this mode.

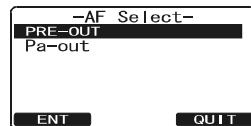
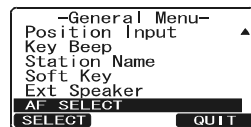
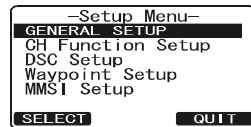

7 CONTROLS AND INDICATORS

NOTE

This section defines each control of the transceiver. For operating instructions refer to section “8 BASIC OPERATION”.

7.1 FRONT PANEL

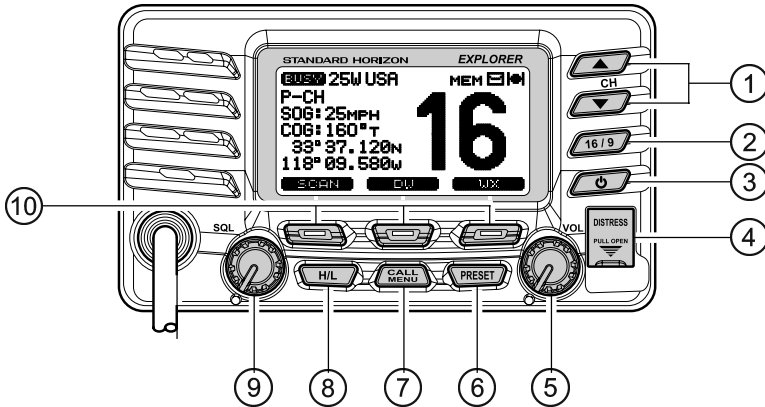

① Key

The keys are used to select channels and to choose menu items (such as the DSC menu, Radio Setup and DSC Setup menu). / keys on the microphone can also be used to select channels and menu items.

SECONDARY USE















While holding down the **SCAN** soft key and pressing key, you can confirm memory channels that have been programmed for scanning.

② Key

Press the key briefly to recall channel 16 from any channel location. Press and hold the key to recall channel 9. Pressing the key again reverts to the previous selected working channel.

③ Key

Turns the transceiver on and off. To turn the transceiver on, press and hold this key until the LCD turns on. To turn it off, press and hold this key until the LCD turns off. When the power is turned on, the transceiver is set to the last-selected channel.

- ④  Key
Used to send a DSC Distress Alert. To transmit a Distress Alert refer to section “**9.3.1 Transmitting a DSC Distress Alert**”.
- ⑤ **VOL** Knob (Volume Control Knob)
Adjusts the audio volume level. Turn this knob clockwise to increase the audio volume level.
SECONDARY USE
When a **RAM3** is connected and intercom mode is selected, controls the listen volume.
- ⑥  Key
Press this key to select the Preset Memory Bank, “**P SET**” will be shown on the display. To exit Preset Memory bank, press the  key again or press the  key. Press the  or  key to select the desired preset channel.
Refer to section “**8.10.1 Programming a Preset Channel**” to program the Preset channels.
- ⑦  Key
Press the  key to access the “DSC MENU”.
SECONDARY USE
Press and hold the  key to access the “SETUP MENU”.
- ⑧  Key
Press the  key to toggle between 25 W (High) and 1 W (Low) power. When the TX output power is set to “Low” while the transceiver is on channel 13 or 67, the output power will temporarily switch from “Low” to “High” power until the **PTT** is released. The  key does not function on transmit inhibited and low power only channels.
- ⑨ **SQL** Knob (Squelch Control)
Adjusting this control clockwise, sets the point at which random noise on the channel does not activate the audio circuits but a received signal does. This point is called the squelch threshold. Further adjustment of the squelch control will degrade reception of wanted transmissions.
- ⑩ Soft Keys
The 3 soft keys functions can be customized by the Setup Menu mode section “**10.11 SOFT KEYS**”. When one of the soft keys is pressed briefly, the functions will appear above each key on the display.
The factory defaults are Key 1: , Key 2: , and Key 3:  function.

7.2 REAR PANEL

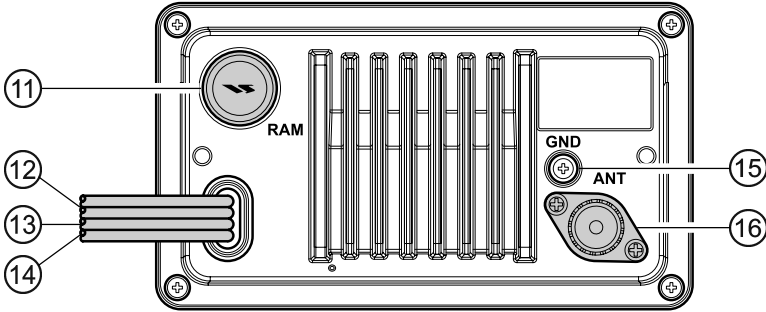

- ① **RAM3 Connector (Remote Station Microphone Connector)**
Connects the **GX1600** to the **RAM3 (CMP30)** Remote Station Microphone. Refer to section “**14 RAM3 (CMP30) REMOTE MIC OPERATION**” for details
- ② **DC Input Cable**
Connects the radio to a DC power supply capable of delivering 11 to 16V DC.
- ③ **Accessory Connection Cable (Green, Blue, Gray, & Brown)**
Connects the **GX1600** to a GPS receiver. Refer to section “**6.5 ACCESSORY CABLE**”.
- ④ **External Speaker Connection Cable (White & Shield)**
an external speaker. See section “**3 OPTIONS**” for a list of optional **STANDARD HORIZON** Speakers.
- ⑤ **GND Terminal (Ground Terminal)**
Connecting a Ground wire to this connection will help reduce engine noise when receiving and transmitting.
Use the screw supplied with the radio only.
- ⑥ **ANT Jack (Antenna Jack)**
Connects an antenna to the transceiver. Use a marine VHF antenna with an impedance of 50 ohms.

7.3 MICROPHONE

⑰ PTT (Push-To-Talk) Switch

When in radio mode and the **PTT** switch pressed, the transmitter is enabled for voice communications to another vessel.

When an optional **RAM3** second station microphone is connected and intercom mode is selected, pressing the **PTT** switch enables voice communications from the **GX1600** to the **RAM3** second station microphone.

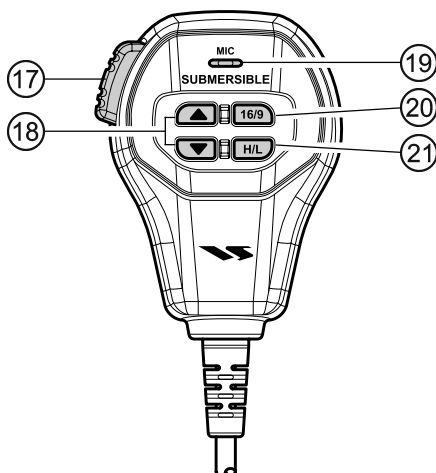

⑱ ▲ / ▼ Keys

The ▲ and ▼ keys on the microphone function the same as the ▲ and ▼ keys on the front panel of the transceiver.

⑲ Microphone

Transmits the voice message with reduction of background noise, using Clear Voice Noise Reduction Technology.

NOTE

Be sure your mouth is about 1/2 inch (1.3 cm) from the mic hole for best performance.

⑳ 16/9 Key

The 16/9 key on the microphone functions the same as the 16/9 key on the front panel of the transceiver.

Immediately recalls channel 16 from any channel location. Holding down this key recalls channel 9. Pressing the 16/9 key again reverts to the previously selected working channel.



㉑ H/L Key

The H/L key on the microphone functions the same as the H/L key on the front panel of the transceiver.

Press this key to toggle the transmit output power between 25 W (High) and 1 W (Low) power.

8 BASIC OPERATION

8.1 RECEPTION

1. After the transceiver has been installed, ensure that the power supply and antenna are properly connected.
2. Press and hold the  key until the radio turns on.
3. Rotate the **SQL** knob fully counterclockwise until “**BUSY**” is shown on the display. This state is known as “unsquelched”.
4. Rotate the **VOL** knob until noise or audio from the speaker is at a comfortable level.
5. Rotate the **SQL** knob clockwise until the random noise disappears and the “**BUSY**” icon is turned off. This state is known as the “squelch threshold.”
6. Press the / key to select the desired channel. Refer to section “**16 CHANNEL ASSIGNMENTS**” for available channels.
7. When a message is received, adjust the volume to the desired listening level. The “**BUSY**” indicator on the display indicates communications is being received or the radio is unsquelched.

8.2 TRANSMISSION

1. Perform steps 1 through 6 of RECEPTION.
2. Before transmitting, monitor the channel to ensure it is clear.
THIS IS AN FCC REQUIREMENT!
3. Press the **PTT** (push-to-talk) switch. The “**TX**” indicator on the LCD is displayed.
4. Speak slowly and clearly into the microphone.
5. When the transmission is finished, release the **PTT** switch.

NOTE

This is a noise-canceling microphone. Position the Oval Slot label “**MIC**” within 1/2 inch (1.3 cm) from the mouth for optimum performance.

8.3 TRANSMIT TIME - OUT TIMER (TOT)

When the **PTT** switch on the microphone is held down, transmit time is limited to 5 minutes. This limits unintentional transmissions due to a stuck microphone. About 10 seconds before automatic transmitter shutdown, a warning beep will be heard from the speaker(s). The transceiver will automatically go to receive mode, even if the **PTT** switch is continually held down. Before transmitting again, the **PTT** switch must first be released and then pressed again.

8.4 SIMPLEX/DUPLEX CHANNEL USE

Refer to section “**16 CHANNEL ASSIGNMENTS**” for instructions on use of simplex and duplex channels.

NOTE

All channels are factory-programmed in accordance with FCC (USA), Industry Canada (Canada), and International regulations. Mode of operation cannot be altered from simplex to duplex or vice-versa.

8.5 DISPLAY TYPE

The **GX1600** display can be setup to show displays other than the default “NORMAL” VHF display by using the procedure below:

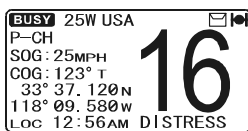

“NORMAL” DISPLAY

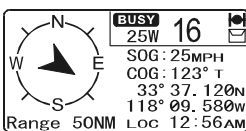

“COMPASS” DISPLAY

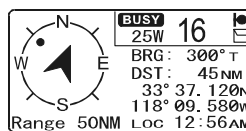



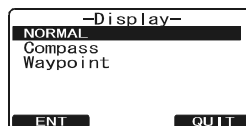
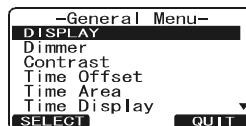
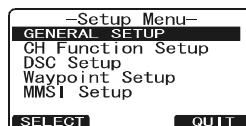

“WAYPOINT” DISPLAY

1. Press and hold down the **CALL MENU** key until “Setup Menu” appears, then select “GENERAL SETUP” with the **▲/▼** key.
2. Press the **SELECT** soft key, then press the **▲/▼** key to select “DISPLAY”.
3. Press the **SELECT** soft key.
4. Press the **▲/▼** key to select desired screen “NORMAL”, “COMPASS”, or “WAYPOINT”.
5. Press the **SELECT** soft key to store the selected setting.
6. Press the **QUIT** soft key several times to return to radio operation.

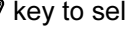

8.6 USA, CANADA, AND INTERNATIONAL MODE

To change the channel group from USA to Canada or International:

1. Press and hold down the  key until "Setup Menu" appears.
2. Press the  key to select "CH FUNCTION SETUP".
3. Press the **SELECT** soft key, then press the  key to select "CH GROUP".
4. Press the **SELECT** soft key.
5. Press the  key to select desired channel group "USA", "INTL", or "CANADA".
6. Press the **ENT** soft key to store the selected setting.
7. Press the **QUIT** soft key several times to return to radio operation.

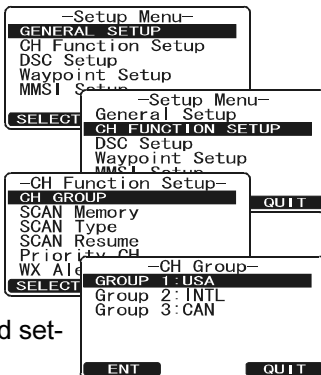

8.7 NOAA WEATHER CHANNELS

1. To receive a NOAA weather channel, press the one of the Soft keys momentarily, then press the **WX** soft key from any channel. The transceiver will go to the last selected weather channel.
2. Press the  key to select a different NOAA weather channel.
3. To exit from the NOAA weather channels, press the one of the Soft keys momentarily, then press the **WX** soft key. The transceiver returns to the channel it was on prior to a weather channel.

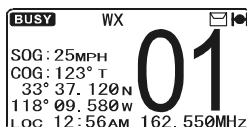

8.7.1 NOAA Weather Alert

In the event of extreme weather disturbances, such as storms and hurricanes, the NOAA (National Oceanic and Atmospheric Administration) sends a weather alert accompanied by a 1050 Hz tone and subsequent weather report on one of the NOAA weather channels.

The **GX1600** can receive weather alerts when on a weather channel and on the last selected weather channel during scanning modes or while on another channel.

When an alert is received on a NOAA weather channel, scanning will stop and the transceiver will emit a loud beep to alert the user of a NOAA broadcast. Press any key to stop the alert and receive the weather report. Press the **QUIT** key to return to the last selected channel.

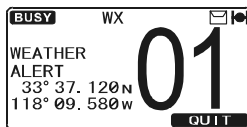

To disable the Weather Alert function, refer to section "11.6 WEATHER ALERT".

NOTE

If a key is not pressed the alert will sound for 5 minutes and then the weather report will be received.

NOTE

While listening to a weather channel, the radio can decode a weather alert and sound an alarm.

8.7.2 NOAA Weather Alert Testing

NOAA tests the alert system ever Wednesday between 11AM and 1PM. To test the **GX1600**'s NOAA Weather feature, on Wednesday between 11AM and 1PM, setup as in section "8.7.1 NOAA Weather Alert" and confirm the alert is heard.

8.8 DUAL WATCH (TO CHANNEL 16)

Dual watch is used to scan two channels for communications. One channel is a normal VHF channel and the other is the priority, channel 16. When a signal is received on the normal channel the radio briefly switches between the normal channel and Channel 16 to look for a transmission. If the radio receives communications on channel 16 the radio stops and listens to Channel 16 until communication ends and then starts Dual watch scan again.

1. Adjust the **SQL** knob until the background noise disappears.
2. Select the channel you wish to dual watch to the priority channel 16.
3. Press the one of the Soft keys, then press the **DW** soft key.

The display will scan between CH16 and the channel that was selected in step 2.

If a transmission is received on the channel selected in step 2, the **GX1600** will dual watch to CH16.

4. To stop Dual Watch, press the one of the soft keys, then press the **DW** soft key again.

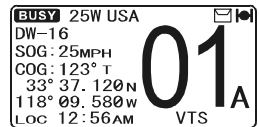









NOTE

The priority channel may be changed from Ch16 to another channel. Refer to section "11.5 PRIORITY CHANNEL".

8.9 SCANNING







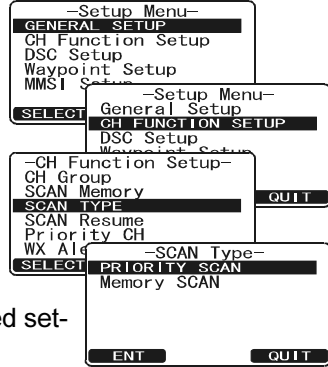

Allows the user to select the scan type from Memory scan or Priority scan. “Memory scan” scans the channels that were programmed into memory. “Priority scan” scans the channels programmed in memory with the priority channel.

8.9.1 Scan Type Selection

1. Press and hold down  key until “Setup Menu” appears.
2. Press the  key to select “CH FUNCTION SETUP”.
3. Press the  soft key, then press the  key to select “SCAN TYPE”.
4. Press the  soft key.
5. Press the  key to select “PRIORITY SCAN” or “MEMORY SCAN”.
6. Press the  soft key to store the selected setting.
7. Press the  soft key several times to return to radio operation.



8.9.2 Scan Memory Programming

1. Press and hold down the  key until “Setup Menu” appears.
2. Press the  key to select “CH FUNCTION SETUP”.
3. Press the  soft key, then press the  key to select “SCAN MEMORY”.
4. Press the  soft key.
5. Press the  key to select a desired channel to be scanned, then press the  soft key. “MEM” icon appears on the display, which indicates the channel has been selected to the scan channel.
6. Repeat step 5 for all the desired channels to be scanned.
7. To DELETE a channel from the list, select the channel then press the  soft key. “MEM” icon disappears from the display.
8. When you have completed your selection, press the  soft key several times to return to radio operation.

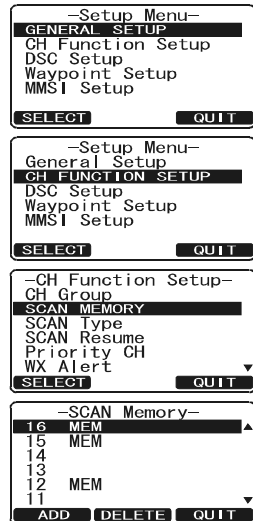

8.9.3 Memory Scanning (M-SCAN)

1. Adjust the **SQL** knob until background noise disappears.
2. Press the one of the Soft keys momentarily, then press the **SCAN** soft key. “**M-SCAN**” appears on the display. Scanning will proceed from the lowest to the highest programmed channel number and Preset channel (described in the next chapter) and will stop on a channel when a transmission is received.
3. The channel number will blink during reception.
4. To stop scanning, press the **16/9** key.

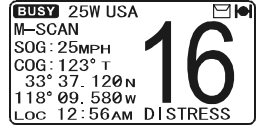

8.9.4 Priority Scanning (P-SCAN)

By default, Channel 16 is set as the priority channel. You may change the priority channel to the desired channel from Channel 16 by the Radio Setup Mode, refer to section “**11.5 PRIORITY CHANNEL**”.

1. Adjust the **SQL** knob until background noise disappears.
2. Press the one of the Soft keys momentarily, then press the **SCAN** key. “**P-SCAN**” appears on the display. Scanning will proceed between the memorized channels and Preset channel (described in next chapter) and the priority channel. The priority channel will be scanned after each programmed channel.
3. To stop scanning, press the **16/9** key.

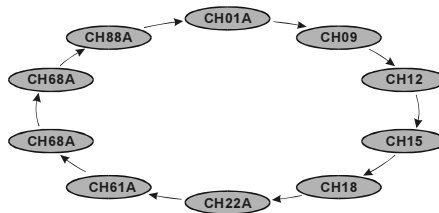
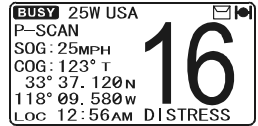

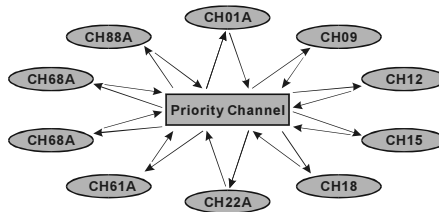

MEMORY SCAN (M-SCAN)







PRIORITY SCAN (P-SCAN)

8.10 PRESET CHANNELS (0 ~ 9): INSTANT ACCESS



10 Preset Channels can be programmed for instant access. Pressing the  key activates the preset channel bank. If the  key is pressed and no channels have been assigned, an alert beep will be emitted from the speaker.

8.10.1 Preset Channel Programming

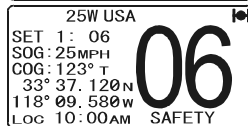
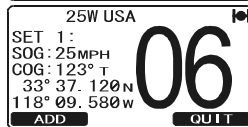
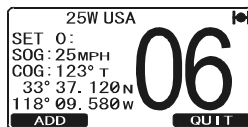
1. Press the  key to select the channel to be programmed.
2. Press and hold the  key until the channel number is blinking.
3. Press the  key to select the desired Preset channel position (“SET 0” - “SET 9”) you wish to program.
4. Press the  soft key momentarily to program the channel into the Preset channel.
5. Repeat steps 1 through 4 to program the desired channels into Preset Channels “0” ~ “9”.





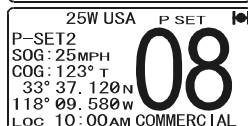
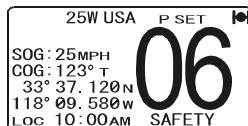

8.10.2 Operation

1. Press the  key to recall the Preset Channel. The “P SET” icon will appear on the display.
2. Press the  key to select the desired Preset Channel (“0” ~ “9”). The Preset Channel number appears (“P-SET0” - “P-SET9”) while selecting the Preset Channel.
3. Press the  key again to return to the last selected channel. The “P SET” icon will disappear from the display.



8.10.3 Deleting a Preset Channel

1. Press the  key.
2. Press the  key to select the Preset Channel to be deleted.
3. Press and hold the  key until the channel number is blinking.
4. Press the  soft key momentarily to delete the channel from the Preset Channel.
5. Repeat steps 2 through 4 to delete the desired channels from Preset Channels “0” ~ “9”.
6. To finish the deleting the Preset Channel, press the  soft key

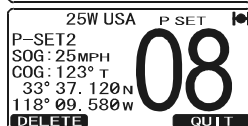
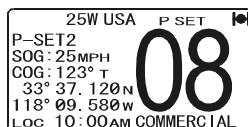

8.11 INTERCOM OPERATION

An optional **RAM3 (CMP30)** must be connected to perform intercom functions between the radio and the **RAM3 (CMP30)**.

In addition, To access the following Intercom functions one of the soft keys must be setup as **IC**. Refer to section “10.11 SOFT KEYS.

8.11.1 Communication

1. Press the one of the Soft keys momentarily, then press the **IC** soft key to enable the intercom mode.

Note: Depending on the programming of the **IC** soft key, the **NEXT** soft key may have to be pressed to see the **IC** soft key.



2. When the intercom mode is enabled, “Intercom” is displayed on the radio and **RAM3 (CMP30)** Remote Station Microphone.



(GX1600's PTT switch is pressed)

3. Press the **PTT** switch on the radio. “Talk” will be shown on the display.

Note: A warning beep will be heard if the **PTT** button on the **GX1600** and **RAM3 (CMP30)** microphone are pushed simultaneously.

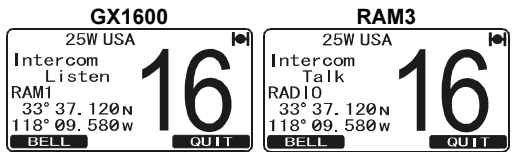

(RAM3's PTT switch is pressed)

4. Speak slowly and clearly into the microphone, hold the microphone about 1/2 inch away from your mouth.
5. When finished, release the **PTT** switch.
6. Press the **QUIT** soft key to exit intercom mode and revert to radio mode.

8.11.2 Calling

Press the **BELL** soft key when in intercom mode on either the radio or **RAM3 (CMP30)** mic will produce a calling beep to the other station.

9 DIGITAL SELECTIVE CALLING

9.1 GENERAL

WARNING

This radio is designed to generate a digital maritime distress and safety call to facilitate search and rescue. To be effective as a safety device, this equipment must be used only within communication range of a shore-based VHF marine channel 70 distress and safety watch system. The range of signal may vary but under normal conditions should be approximately 20 nautical miles.

NOTE

A DSC Warning sticker is included with the **GX1600**. To comply with FCC regulations this sticker must be mounted in a location that can be easily viewed from the location of the **GX1600**.

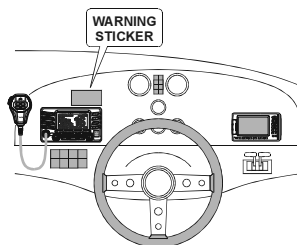

Digital Selective Calling is a semi-automated method of establishing a radio call, it has been designated by the International Maritime Organization (IMO) as an international standard for establishing VHF, MF and HF radio calls. It has also been designated as part of the Global Maritime Distress and Safety System (GMDSS).

Digital Selective Calling allows mariners to instantly send a distress call with GPS position (when connected to the transceiver) to the US Coast Guard and other vessels within range of the transmission. DSC will also allow mariners to initiate or receive Distress, Urgency, Safety, Routine, Position Request, Position Report, Automatic Position Polling and Group calls to or from another vessel equipped with a DSC transceiver.

9.2 MARITIME MOBILE SERVICE IDENTITY (MMSI)

9.2.1 What is an MMSI?

An MMSI is a nine digit number used on Marine Transceivers capable of using Digital Selective Calling (DSC). This number is used like a telephone number to selectively call other vessels.

THIS NUMBER MUST BE PROGRAMMED INTO THE RADIO TO OPERATE DSC FUNCTIONS.

How can I obtain an MMSI assignment?

In the USA, visit the following websites to register:

<http://www.boatus.com/mmsi/> or

http://seatow.com/boating_safety/mmsi.asp

In the Canada, visit





<http://www.ic.gc.ca/epic/site/smt-gst.nsf/en/sf01032e.html> or

<http://www.usps.org/php/mmsi/rules.php>

9.2.2 Programming the MMSI

WARNING

A user MMSI can be inputted only once. Therefore **please be careful not to input the incorrect MMSI number.** If you need to change the MMSI number after it has been entered, the radio will have to be returned to Factory Service. Refer to the section “**15.2 FACTORY SERVICE.**”

1. Press and hold down the  key until the “Setup Menu” appears.
2. Press the  key to select “MMSI SETUP”.
3. Press the **SELECT** soft key. (To cancel, press the **QUIT** soft key.)
4. Press the  key to select the first number of your MMSI, then press the **ENT** soft key to step to the next number.
5. Repeat step 4 to set your MMSI number (nine digits).
6. If a mistake was made entering in the MMSI number, press the **BACK** soft key until the wrong number is selected, then press the  key to correct the entry and press the **ENT** soft key.
7. When finished programming the MMSI number, press and hold the **ENT** soft key. The radio will ask you to input the MMSI number again. Use steps 4 - 6 above.
8. After the second number has been input, press and hold the **ENT** soft key to store the MMSI.
9. Press the **OK** soft key to return to radio operation.

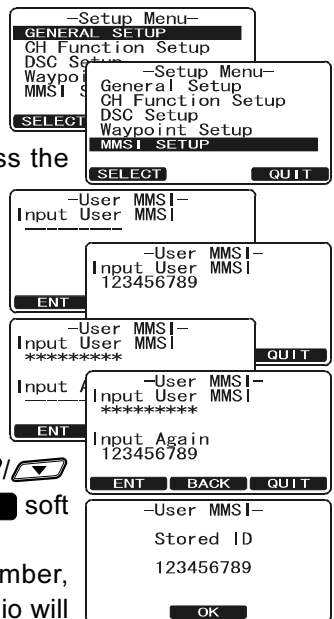

NOTE

To view your MMSI after programming to ensure it is correct, perform steps 1~3. Look that the MMSI number shown on the display is correct.



9.3 DSC DISTRESS ALERT

The **GX1600** is capable of transmitting and receiving DSC Distress messages with your vessels position when connected to a GPS with NMEA 0183 output. Refer to section “**6.5 ACCESSORY CABLE**”.

9.3.1 Transmitting a DSC Distress Alert

NOTE

To be able to transmit a DSC Distress Alert an MMSI number must be programmed, refer to section “**9.2.2 Programming the MMSI.**” In order for your ships location to be transmitted a GPS must be connected to the **GX1600**, refer to section “**6.5 ACCESSORY CABLE.**”

1. Lift the red spring loaded DISTRESS cover and press the  key. The “DISTRESS ALERT” menu will appear on the display.
2. Press and hold the  key. The radios display will count down (3-2-1) and then transmit the Distress Alert. The backlight of the display and keypad flashes while the radios display is counting down.
3. When the distress signal is sent, the transceiver watches for a transmission between CH16 and CH70 until an acknowledgment signal is received.
4. If no acknowledgment is received, the distress call is repeated in 4 minute intervals until a DSC acknowledgment is received.
5. When a DSC Distress acknowledgment is received, a distress alarm sounds and channel 16 is automatically selected. The display shows the MMSI of the ship responding to your distress.
RECEIVED ACK: acknowledgment signal is received.
RECEIVED RLY: relay signal is received from another vessel or coast station.
6. Press the **PTT** button and state your name, vessel name, number of persons on board and the distress situation, then say over and wait for a reply from the acknowledging ship.
7. To momentarily turn off the Distress alarm until the radio retransmits the distress call, press the  key.

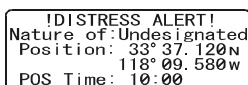

!DISTRESS ALERT!
Nature of:Undesignated
Position: 33° 37. 120N
118° 09. 580W
POS Time: 10:00



Time for 3 sec
NATURE POS/TM QUIT

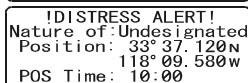

!DISTRESS ALERT!
Nature of:Undesignated
Position: 33° 37. 120N
118° 09. 580W
POS Time: 10:00



Time for 3 sec

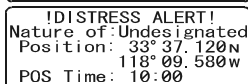

!DISTRESS ALERT!
Nature of:Undesignated
Position: 33° 37. 120N
118° 09. 580W
POS Time: 10:00



Transmitting

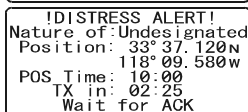

!DISTRESS ALERT!
Nature of:Undesignated
Position: 33° 37. 120N
118° 09. 580W
POS Time: 10:00
TX in: 02:25
Wait for ACK



PAUSE CANCEL



!DISTRESS ALERT!
Received Acknowledged
Name:USCG
ID:101234567

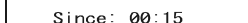

Since: 00:15





OK

9.3.1.1 Transmitting a DSC Distress Alert with Nature of Distress

The **GX1600** is capable of transmitting a DSC Distress Alert with the following “Nature of Distress” categories you may have:

Undesignated, Fire, Flooding, Collision, Grounding, Capsizing, Sinking, Adrift, Abandoning, Piracy, MOB

1. Lift the red spring loaded DISTRESS cover and press the **DISTRESS** key. The “DISTRESS ALERT” menu will appear on the display.
2. Press the **NATURE** soft key, then press the   key to select the desired nature of distress category.
3. Press and hold the **DISTRESS** key. The radios display will count down (3-2-1) and then transmit the Distress Alert. The backlight of the display and keypad flashes while the radios display is counting down.
4. When the distress signal is sent, the transceiver watches for a transmission between CH16 and CH70 until an acknowledgment signal is received.
5. If no acknowledgment is received, the DSC distress call is repeated in 4 minute intervals until an acknowledgment is received.
6. When a DSC Distress acknowledgment is received, a distress alarm sounds and channel 16 is automatically selected. The display shows the MMSI of the ship responding to your distress.
 RECEIVED ACK: acknowledgment signal is received.
 RECEIVED RLY ACK: relay acknowledgment signal is received from another vessel or coast station.
7. Press the **PTT** button and state your name, vessel name, number of persons on board and the distress situation, then say over. wait for a reply from the acknowledging ship.
8. To momentarily turn off the Distress alarm until the radio retransmits the distress call, press the  key.

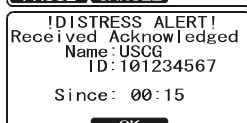
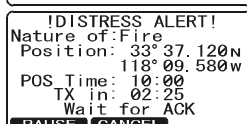
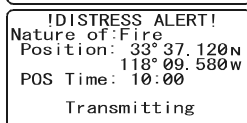
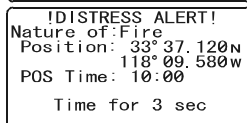
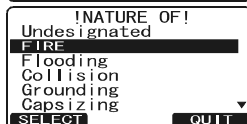
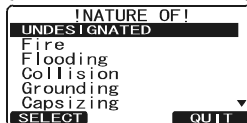
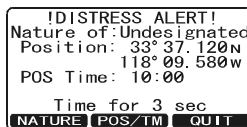

9.3.1.2 Transmitting a DSC Distress Alert by Manually Entering a Position

When the **GX1600** is not connected to a GPS receiver or the GPS has a problem, you may input the latitude/longitude of your vessel manually and may send DSC Distress Alert.

1. Lift the red spring loaded **DISTRESS** cover and press the **DISTRESS** key. The "DISTRESS ALERT" menu will appear on the display.

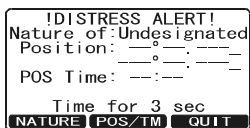

2. Press the **POS/TM** soft key.

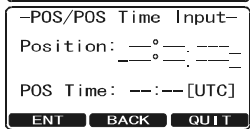

3. Enter the latitude/longitude of your vessel and your local UTC time in the 24-hour notation. Press the **▲/▼** key to select the number and press the **ENT** soft key to move the cursor to the next character. You may backspace the cursor by pressing the **BACK** soft key, if you make a mistake.

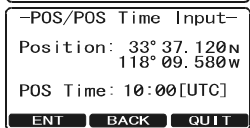

4. When you have completed your selection, press and hold in the **ENT** soft key for two seconds to save the setting.

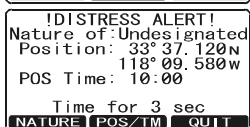

5. Press and hold the **DISTRESS** key. The radios display will count down (3-2-1) and then transmit the Distress Alert. The backlight of the display and keypad flashes while the radios display is countdown.

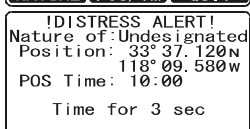

6. When the distress signal is sent, the transceiver "shadow-watches" for a transmission between CH16 and CH70 until an acknowledgment signal is received.

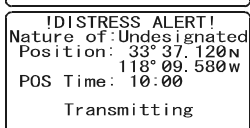

7. If no acknowledgment is received, the distress call is repeated in 4 minute intervals until an acknowledgment is received.

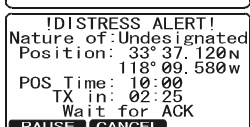

8. When a DSC Distress acknowledgment is received, a distress alarm sounds and channel 16 is automatically selected. The display shows the MMSI of the ship responding to your distress.

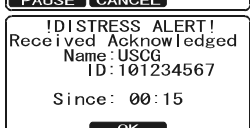

RECEIVED ACK: acknowledgment signal is received.

RECEIVED RLY ACK: relay acknowledgment signal is received from another vessel or coast station.

9. Press the **PTT** button and state your name, vessel name, number of persons on board and the distress situation, then say over. wait for a reply from the acknowledging ship.

10. To turn off the Distress alarm until the radio retransmits the distress call, press the **16/9** key.

9.3.1.3 Pausing a DSC Distress Call

After a DSC Distress call is transmitted, the DSC distress call is repeated every 4 minutes until the call is canceled by the user or until the radio is turned on and off again. The **GX1600** has provision to suspend (Pause) the retransmitting of the distress call by the procedure below.

1. After the distress call is transmitted, the radio will show the top display to the right.

Looking at this display you will notice TX in: 02:25, this is the time when the radio will re-transmit the DSC distress call.

2. To suspend re-transmitting the DSC call, press the **PAUSE** soft key.
3. To resume counting down to transmit the DSC Distress call, press the **RESUME** soft key.

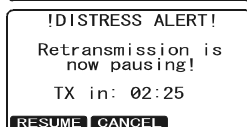
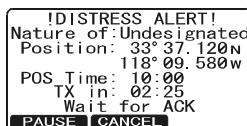

9.3.1.4 Cancel a DSC Distress Call

If a DSC Distress call was sent by error the **GX1600** allows you to send a message to other vessels to cancel the Distress Call that was made.

Press the **CANCEL** soft key, then press **YES** soft key.

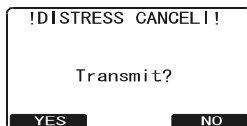
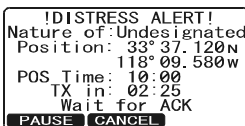

9.3.2 Receiving a DSC Distress Call

1. When a DSC Distress call is received, an emergency alarm sounds.
2. Press any key to stop the alarm.

3. The display shows the position of the vessel in distress. To show additional information of the vessel in distress, press the  key (refer to the second display).



On the display you will notice 3 soft key selections. These selections are described below:

- a. **ACCEPT**: Accept to auto switching to Channel 16.

Note: If a key is not pressed for 30 seconds or longer the radio will automatically select Channel 16.

- b. **PAUSE**: Temporarily suspend switching to channel 16.

- c. **QUIT**: Exit to the working channel.

4. Press the **WPT** soft key to enter the “Waypoint Input” menu, then enter the desired waypoint name (up to 11 characters), described previously (select the letter/number by pressing the / key and move the

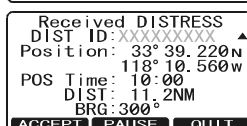
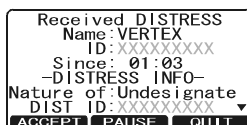

- cursor by pressing the **ENT** / **BACK** soft key).
- The ID is the MMSI from the vessel in distress.
 - When you are finished entering the waypoint name, press and hold the **ENT** soft key to replace the display to the "WAYPOINT" Screen. The display indicates the distance and direction of the vessel in distress by a dot (●).
 - To stop navigating to a waypoint, press the one of the Soft keys, then press the **STOP** soft key. The radio is switched to Normal Mode.

NOTE

You must continue monitoring channel 16 as a coast station may require assistance in the rescue attempt.

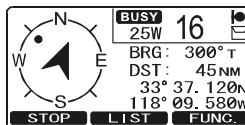
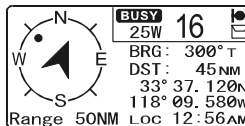
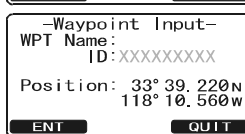
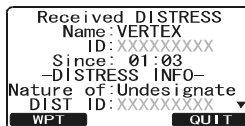

9.4 ALL SHIPS CALL

The All Ships Call function allows contact to be established with DSC equipped vessels without having their MMSI in the individual calling directory. Also, priority for the call can be designated as Urgency or Safety.

URGENCY Call: This type of call is used when a vessel may not truly be in distress, but have a potential problem that may lead to a distress situation. This call is the same as saying PAN PAN PAN on channel 16.

SAFETY Call: Used to transmit boating safety information to other vessels. This message usually contains information about an overdue boat, debris in the water, loss of a navigation aid or an important meteorological message. This call is the same as saying Securite, Securite, Securite.”

9.4.1 Transmitting an All Ships Call

1. Press the **CALL MENU** key. The “DSC Menu” will appear.
2. Press the **▲/▼** key to select “All SHIPS”.
3. Press the **SELECT** soft key. (To cancel, press the **QUIT** soft key.)
4. Press the **▲/▼** key to select the nature of call (“SAFETY” or “URGENCY”), then press the **SELECT** soft key.
5. Press the **▲/▼** key to select the operating channel you want to communicate on, then press the **SELECT** soft key. If the channel you want to use is not listed, press the **MANUAL** soft key, then press the **▲/▼** key to select the operating channel you want to communicate on (default is channel 16), then press the **SELECT** soft key.
6. Press the **YES** soft key to transmit the selected type of all ships DSC call.
7. After the All Ships Call is transmitted, the transceiver will switch to the selected channel.
8. Listen to the channel to make sure it is not busy, then key the microphone and say PAN PAN PAN or “Securite, Securite, Securite” depending on the priority of the call and state your message.
9. Press the **QUIT** soft key to exit the ALL ship call menu.

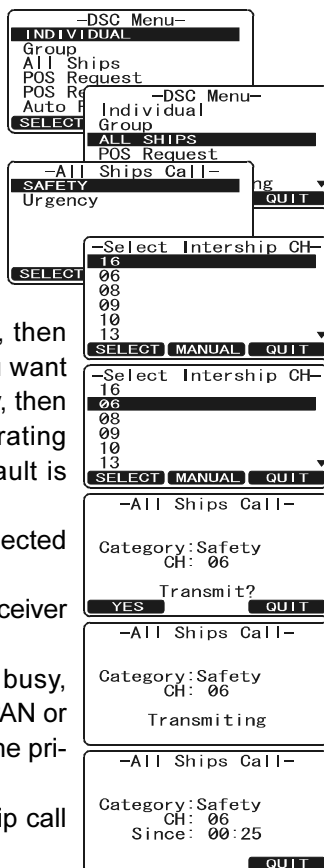

9.4.2 Receiving an All Ships Call

1. When an all ships call is received, an emergency alarm will sound.

The display shows the MMSI of the vessel transmitting the All Ships Call and the radio will change to the requested channel after 10 seconds.

2. Press any key to stop the alarm.
3. Monitor the requested channel until the ALL SHIPS voice communication is completed.

On the display you will notice 3 soft key selections. These selections are described below:

- a. **ACCEPT**: Accept to auto switching to Channel 16.

Note: If a key is not pressed for 30 seconds or longer the radio will automatically select Channel 16.

- b. **PAUSE**: Temporarily suspend switching to channel 16.
- c. **QUIT**: Exit to the working channel.

4. Press the **QUIT** soft key to return to the channel display.

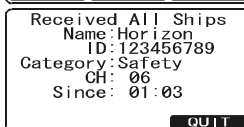
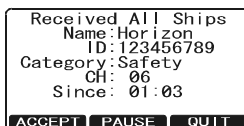







9.5 INDIVIDUAL CALL

This feature allows the **GX1600** to contact another vessel with a DSC VHF radio and automatically switch the receiving radio to a desired communications channel. This feature is similar to calling a vessel on CH16 and requesting to go to another channel (switching to the channel is private between the two stations). Up to 80 Individual contacts may be programmed.



9.5.1 Individual / Position Call Directory Setup

The **GX1600** has a DSC directory that allows you to store a vessel or person's name and the MMSI number associated with vessels you wish to transmit Individual calls, Auto Polling, Position Request, and Position Report transmissions.

To transmit an Individual call you must program this directory with information of the persons you wish to call, similar to a cellular phones telephone directory.

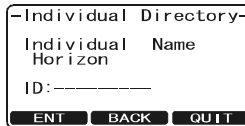
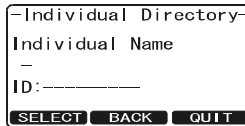
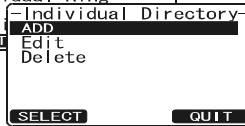
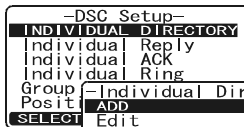
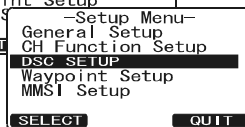
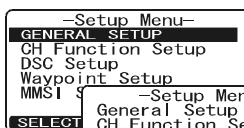
1. Press and hold down the  key until "Setup Menu" appears.
2. Press the  key to select "DSC SETUP" menu.
3. Press the **SELECT** soft key, then select "INDIVIDUAL DIRECTORY" with the  key.
4. Press the **SELECT** soft key.
5. Select "ADD" with the  key, then press the **SELECT** soft key.
6. Press the  key to scroll through the first letter of the name of the vessel or person you want to reference in the directory.
7. Press the **ENT** soft key to store the first letter in the name and step to the next letter to the right.
8. Repeat step 6 and 7 until the name is complete. The name can consist of up to eleven characters, if you do not use all eleven characters press the **ENT** soft key to move to the next space. This method can also be used to enter a blank space in the name. If a mistake was made entering in the name repeat pressing the **BACK** soft key until the wrong character is selected, then press the  key to correct the entry.
9. After the eleventh letter or space has been entered, press and hold the **ENT** soft key to advance to the MMSI (Maritime Mobile Service Identity Number) number entry.





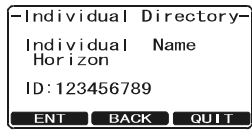

10. Press the  key to scroll through numbers, 0-9. To enter the desired number and move one space to the right by pressing the **ENT** soft key. Repeat this procedure until all nine space of the MMSI number are entered.
11. If a mistake was made entering in the MMSI number repeat pressing the **BACK** soft key until the wrong number is selected, then press the  key to correct the entry.
12. To store the data entered, press and hold the **ENT** soft key.
13. To enter another individual address, repeat steps 5 through 12.
14. Press the **QUIT** soft key several times to return to radio operation.



9.5.2 Individual Reply Setup

This menu item sets up the radio to automatically (default setting) or manually respond to a DSC Individual call requesting you to switch to a working channel for voice communications. When Manual is selected the MMSI of the calling vessel is shown allowing you to see who is calling. This function is similar to caller id on a cellular phone.



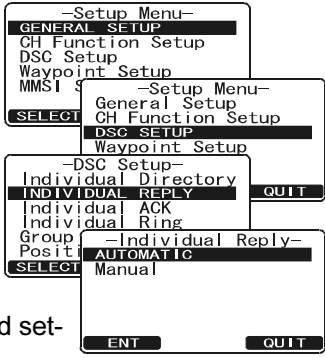

1. Press and hold down the  key until "Setup Menu" appears.
2. Press the  key to select "DSC SETUP" menu.
3. Press the **SELECT** soft key, then select "INDIVIDUAL REPLY" with the  key.
4. Press the **SELECT** soft key.
5. Press the  key to select "AUTOMATIC" or "MANUAL".
6. Press the **ENT** soft key to store the selected setting.
7. Press the **QUIT** soft key several times to return to radio operation.



9.5.3 Individual Acknowledgment Setup

The **GX1600** can select either reply message "Able" (default) or "Unable" when the Individual Reply setting (described previous section) is set to "AUTOMATIC".



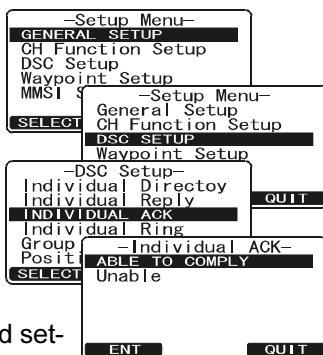

When the Individual Reply setting (described previous section) is set to "AUTOMATIC", the **GX1600** can be setup to reply "Able" (default) or not reply "Unable" to an received Individual Call. When "Unable" is selected the **GX1600** will transmit a "Unable" reply to the calling station to inform them you are away from your radio.

1. Press and hold down the  key until "Setup Menu" appears.
2. Press the  key to select "DSC SETUP" menu.
3. Press the **SELECT** soft key, then select "INDIVIDUAL ACK" with the  key.
4. Press the **SELECT** soft key.
5. Press the  key to select "ABLE TO COMPLY" or "UNABLE".
6. Press the **ENT** soft key to store the selected setting, then press the **QUIT** soft key several times to return to radio operation.





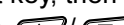

9.5.4 Individual/Group Call Ringer Setup

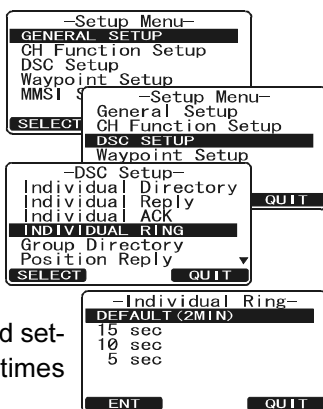
When a Individual Call or Group Call is received the radio will produce a ringing sound for 2 minutes. This selection allows the Individual Call ringer time to be changed.

1. Press and hold down the  key until "Setup Menu" appears.
2. Press the  key to select "DSC SETUP" menu.
3. Press the **SELECT** soft key, then select "INDIVIDUAL RING" with the  key.
4. Press the **SELECT** soft key.
5. Press the  key to select ringing time of a Individual Call.
6. Press the **ENT** soft key to store the selected setting, then press the **QUIT** soft key several times to return to radio operation.



The **GX1600** has the capability to turn off the Individual and Group call ringer.

1. Press and hold down the  key until "Setup Menu" appears.
2. Press the  key to select "DSC SETUP" menu.
3. Press the **SELECT** soft key, then select "DSC BEEP" with the  key.
4. Press the **SELECT** soft key.
5. Press the  key to select "Individual" if you wish to disable the Individual call ringer,

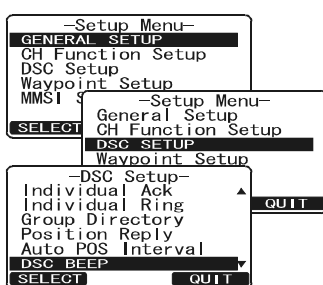

or “Group” if you wish to disable the Group call ringer, then press the **ENT** soft key.

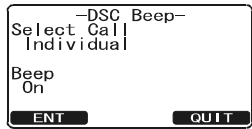

6. Press the key to select “Off”.
7. Press the **ENT** soft key to store the selected setting, then press the **QUIT** soft key several times to return to radio operation.

To re-enable the ringer, repeat the above procedure, pressing the key to select “On” in step “6” above.

NOTE

The **GX1600** may turn on and off the call ringer of the All Ships, POS Request, POS Report, and Geographical as well as the Individual and Group call.

9.5.5 Transmitting an Individual Call

This feature allows the user to contact another vessel with a DSC radio. This feature is similar to calling a vessel on CH16 and requesting to go to another channel.

9.5.5.1 Individual Call using the Individual Directory

1. Press the key. The “DSC Menu” will appear.
2. Press the key to select “INDIVIDUAL”. (To cancel, press the **QUIT** soft key.)
3. Press the **SELECT** soft key.
4. Press the key to select the “Individual” you want to contact.

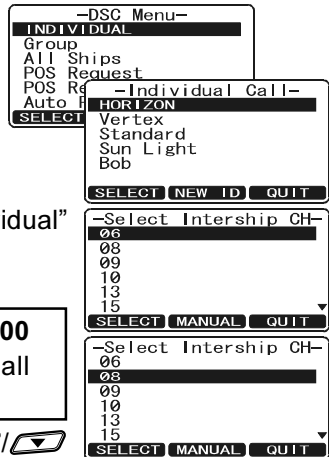

NOTE

To ease making Individual calls, the **GX1600** will show the NAME of last Individual call transmitted.

5. Press the **SELECT** soft key, then press the key to select the operating channel you want to communicate on, then press the **SELECT** soft key. If the channel is not shown in the list, press the **MANUAL** soft key, then press the key to select the operating channel you want to communicate on, then press the **SELECT** soft key.
6. Press the **YES** soft key to transmit the individual DSC signal.

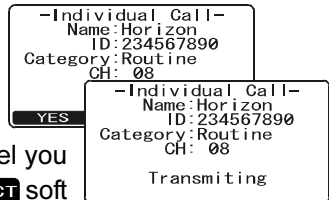

- When an individual call acknowledgment is received, the established channel is automatically changed to the channel selected in step 5 above and a ringing tone sounds.
- Press the **QUIT** soft key to listen to the channel to make sure it is not busy, then press the microphone's **PTT** switch and talk into the microphone to the other vessel.

```

-Individual Call-
Name:Horizon
ID:234567890
Category:Routine
CH: 08
Since: 00:25
Waiting for ACK
QUIT

```

9.5.5.2 Individual Call by Manually Entering a MMSI

You may enter an MMSI number manually to contact another vessel.

- Press the **CALL MENU** key. The "DSC Menu" menu will appear.
- Press the **▲/▼** key to select "INDIVIDUAL". (To cancel, press the **QUIT** soft key.)
- Press the **SELECT** soft key.

NOTE

If you have transmitted a Individual call before, the radio will show the name of the last person you called as shown in the display at the right. If this is the case press the **NEW ID** soft key and the following steps.

- Press the **▲/▼** key to select "MANUAL", then press the **SELECT** soft key.
- Press the **▲/▼** key to select the first number of the MMSI which you want to contact, then press the **SELECT** soft key to step to the next number.
- Repeat step 5 to set the MMSI number (nine digits).
- If a mistake was made entering in the MMSI number, repeat pressing the **BACK** soft key until the wrong number is selected, then press the **▲/▼** key to correct the entry.
- When finished entering the MMSI number, press and hold the **SELECT** soft key.
- Press the **▲/▼** key to select the operating channel you want to communicate on, then press the **SELECT** soft key. If the channel is not shown in the list, press the **MANUAL** soft key, then press the **▲/▼** key to select the operating channel you want to communicate on, then press the **SELECT** soft key.

```

-DSC Menu-
INDIVIDUAL
Group
All Ships
POS Request
POS Report
Auto POS Polling
SELECT QUIT

```

```

-Individual Call-
HORIZON
Vertex
Standard
Sun Light
Bob
SELECT NEW ID QUIT

```

```

-Individual Call-
MANUAL
Horizon
Vertex
Standard
Sun Light
Bob
SELECT QUIT

```

```

-Individual Call-
Input MMSI
ID:-----
SELECT NEXT QUIT

```

```

-Individual Call-
Input MMSI
ID:345678901
SELECT BACK QUIT

```

```

-Select Intership CH-
06
08
09
10
13
15
SELECT MANUAL QUIT

```

```

-Select Intership CH-
06
08
09
10
13
15
SELECT MANUAL QUIT

```

```

-Individual Call-
Name:
ID:345678901
Category:Routine
CH: 08
Transmit?
YES QUIT

```

10. Press the **YES** soft key to transmit the individual DSC signal.
11. When an individual call acknowledgment is received, the established channel is automatically changed to the channel which is selected on step 5 above and a ringing tone sounds.
12. Press the **QUIT** soft key to listen to the channel to make sure it is not busy, then press the microphone's **PTT** switch and talk into the microphone to the other vessel.

```

-Individual Call-
  Name:
  ID: 345678901
  Category: Routine
  CH: 08

  Transmitting
  
```

```

-Individual Call-
  Name:
  ID: 345678901
  Category: Routine
  CH: 08
  Since: 00:25
  Waiting for ACK
  QUIT
  
```

9.5.6 Receiving an Individual Call

When a Individual DSC call is received, the radio will automatically respond (Default setting) to the calling ship, and switch to the requested channel for voice communications. Refer to section “9.5.2 Setting up Individual Reply” to change the reply to manual if you want to see who is calling before replying to the call.

1. When an individual call is received, an individual call ringing alarm sounds.
The radio automatically switches to the requested channel. The display shows the MMSI of the vessel calling.
2. Press any key to stop the alarm.
3. Press the **QUIT** soft key to return to radio operation
4. Press the microphone's **PTT** switch and talk into the microphone to the other vessel.

```

Received Individual
  Name: Horizon
  ID: 123456789
  Category: Routine
  CH: 06
  Since: 01:03
  Connected
  QUIT
  
```

```

BUSY 25W USA
SOG: 25MPH
COG: 123° T
33° 37. 120N
118° 09. 580W
Loc 12:56AM SAFETY
06
  
```

9.6 DSC LOG OPERATION

The **GX1600** logs transmitted calls, received distress calls, and other calls (Individual, Group, All Ship etc.). The DSC Log feature is similar to an answer machine where calls are recorded for review and a “☒” icon will appear on the radios display. The **GX1600** can store up to the latest 24 Transmitted calls, up to the latest 24 Transmitted calls, up to the latest 27 Distress, and up to the latest 64 other calls.

NOTE

The **GX1600** is smart. When select the “DSC LOG” menu, the **GX1600** may display high-priority logged call automatically.

9.6.1 Reviewing and Resending a Logged Transmitted Call

The **GX1600** radios allows logged Transmitted Calls to be reviewed and resend the call.

1. Press the **CALL MENU** key. The “DSC menu” will appear.
2. Press the **▲/▼** key to select “DSC LOG” menu.
3. Press the **SELECT** soft key, then press the **▲/▼** key to select “TRANSMITTED LOG”.
4. Press the **SELECT** soft key, then press the **▲/▼** key to select the station (name or MMSI number) you want to review and/or resend the call.
5. Press the **SELECT** soft key, to review details for the selected station.
6. Press the **CALL** soft key to resend the call, if desired.

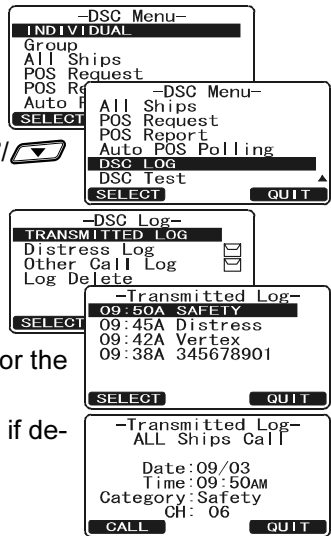



9.6.2 Reviewing a Logged DSC Distress Call

The **GX1600** radios allows logged DSC distress calls to be reviewed.

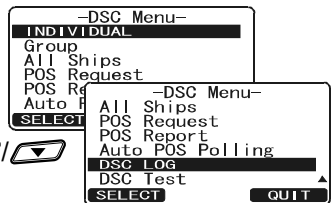
1. Press the **CALL MENU** key. The “DSC menu” will appear.
2. Press the **▲/▼** key to select “DSC LOG” menu.
3. Press the **SELECT** soft key, then press the **▲/▼** key to select “DISTRESS LOG”.



- Press the **SELECT** soft key, then press the  key to select the station (name or MMSI number) you want to review.

Note: When there is an unread received call, “” icon will appear behind the station name (or MMSI number).

- Press the **SELECT** soft key, to review details for the selected station.

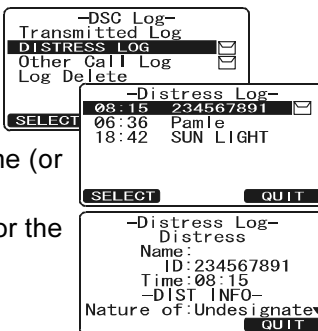



9.6.3 Reviewing a Logged Other Calls

Reviewing a logged other calls (Individual, Group, All Ship etc.).

- Press the  key. The “DSC Menu” will appear.

- Press the  key to select “DSC LOG” menu.

- Press the **SELECT** soft key, then press the  key to select “OTHER CALL LOG”.

- Press the **SELECT** soft key, then press the  key to select the station (name or MMSI number) you want to review.

Note: When there is an unread received call, “” icon will appear behind the station name (or MMSI number).

- Press the **SELECT** soft key, to review details for the selected station.



9.6.4 Deleting a Call from the “DSC LOG” Directory

- Press the  key. The “DSC Menu” will appear.



- Press the  key to select “DSC LOG” menu.

- Press the **SELECT** soft key, then press the  key to select “LOG DELETE” menu.

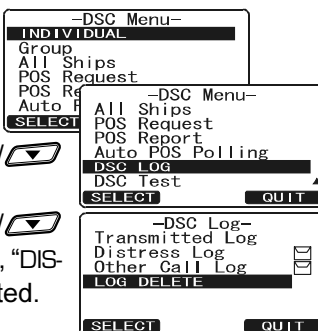



- Press the **SELECT** soft key, then press the  key to select the category (“TRANSMITTED LOG”, “DISTRESS LOG”, or “OTHER CALL LOG”) to be deleted.

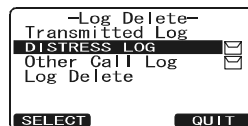

5. Press the **SELECT** soft key.

1) If you want to delete all stations at a time, select the "ALL LOG DELETE" with the / key, then press the **SELECT** soft key, then press the **OK** soft key. Press the **QUIT** soft key several times to return to radio operation.



2) If you want to delete one of the logged stations, select the "VIEW LOG LIST" with the / key, then press the **SELECT** soft key. Press the / key to select the station (name or MMSI number) to be deleted, then press the **DELETE** soft key. The display will show "Are you sure?" press the **OK** soft key.

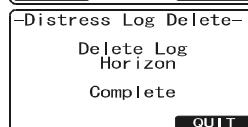
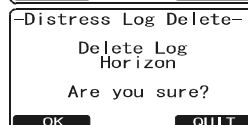
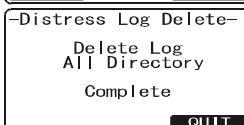
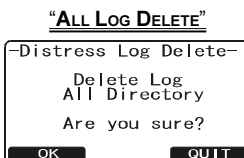

6. Press the **QUIT** soft key several times to return to radio operation.

9.7 GROUP CALL

This feature allows the user to contact a group of specific vessels (example members of a yacht club) using DSC radios with Group call function to automatically switch to a desired channel for voice communications. This function is very useful for yacht clubs and vessels traveling together that want to collectively make announcements on a predetermined channel. Up to 32 Group MMSI may be programmed.

9.7.1 Group Call Setup







For this function to operate, the same Group MMSI must be programmed into all the DSC VHF radios within the group of vessels that will be using this feature. To understand Group MMSI programming, first a Ship MMSI has to be understood.

Ship MMSI: The first three digits called a MID (Mobile Identity Group) of a Ship MMSI denote the country the ship registered for a MMSI. The last 6 digits are specific to the Ships ID.





Ship MMSI Example: If your MMSI is “366123456”, “366” is MID which denote the country and “123456” is your ships MMSI.

Group MMSI:

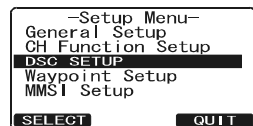
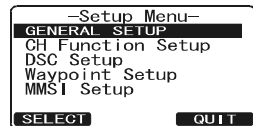
- Group MMSI numbers are not assigned by the FCC or other organizations licensed to assign ship MMSI numbers.
- The first digit of a Group MMSI is always set to “0” by International rules. All Standard Horizon radios are preset so when programming a Group MMSI the first digit is set to “0”.
- The USCG recommends programming the MID of a ships MMSI into the Second, Third and Fourth digits of the Group MMSI as it denotes the area the ship is located in.
- The last 5 digits are decided upon by persons in the Group. This is an important step as all radios in the Group must contain the same Group MMSI so they can be contacted by each other. There is a chance that another group of vessels may program in the same Group MMSI. If this happens, simply change one or more of the last 5 digits of the Group MMSI.

1. Press and hold down the  key until “Setup Menu” appears.
2. Press the  /  key to select “DSC SETUP” menu.
3. Press the **SELECT** soft key, then select “GROUP DIRECTORY” with the  /  key.
4. Press the **SELECT** soft key, then select “ADD” with the  /  key.



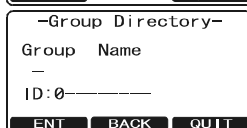
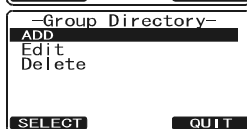

5. Press the **SELECT** soft key.
6. Press the  key to scroll through the first letter of the name of the group you want to reference in the directory.
7. Press the **SELECT** soft key to store the first letter in the name and step to the next letter to the right.
8. Repeat step 6 and 7 until the name is complete. The name can consist of up to eleven characters, if you do not use all eleven characters press the **ENT** soft key to move to the next space. This method can also be used to enter a blank space in the name. If a mistake was made entering in the name repeat pressing the **BACK** soft key until the wrong character is selected, then press the  key to correct the entry.
9. After the eleventh letter or space has been entered, press and hold the **ENT** soft key to advance to the GROUP MMSI (Maritime Mobile Service Identity Number) number entry.
10. Press the  key to select the second number of the MMSI (nine digits: first digit permanently set to "0") which you want to contact, then press the **ENT** soft key to step to the next number. Repeat this procedure until all eight space of the MMSI number are entered.
11. If a mistake was made entering in the MMSI number repeat pressing the **BACK** soft key until the wrong number is selected, then press the  key to correct the entry.
12. To store the data entered, press and hold the **ENT** soft key.
13. To enter another group address, repeat steps 5 through 12.
14. Press the **QUIT** soft key several times to return to radio operation.



9.7.2 Transmitting a Group Call

9.7.2.1 Group Call using the Individual Directory

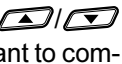
1. Press the  key. The "DSC Menu" will appear.
2. Press the  key to select "GROUP". (To cancel, press the **QUIT** key.)
3. Press the **SELECT** soft key. The transceiver will beep, and the "Last Group Call" will appear.
4. Press the  key to select the "Group" you want to contact.
5. Press the **SELECT** soft key, then press the  key to select the operating channel you want to com-

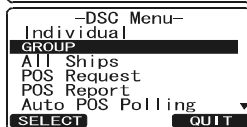
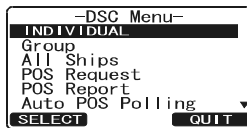

municate on, then press the **SELECT** soft key. If the channel you want is not shown, press the **MANUAL** soft key, then press the / key to select the operating channel you want to communicate on, then press the **SELECT** soft key.

- Press the **YES** soft key to transmit the Group Call signal.
- When the Group Call signal is sent, the display will be as shown in the illustration at the right.
- After the Group Call is transmitted, all the radios in the group will switch to the designated channel.
- Listen to the channel to make sure it is not busy, then press the microphone's **PTT** switch and call the other vessel you desire to communicate with.

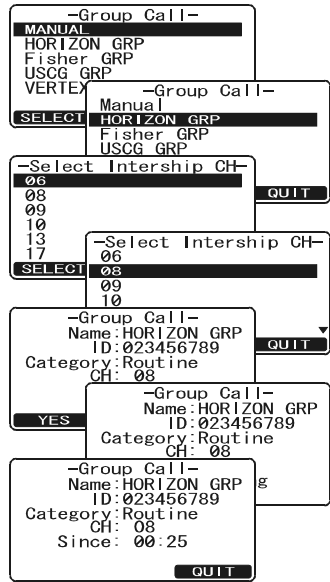



9.7.2.2 Group Call by Manually Entering a MMSI

This feature allows you to contact a group of vessels by entering in their Group MMSI manually.

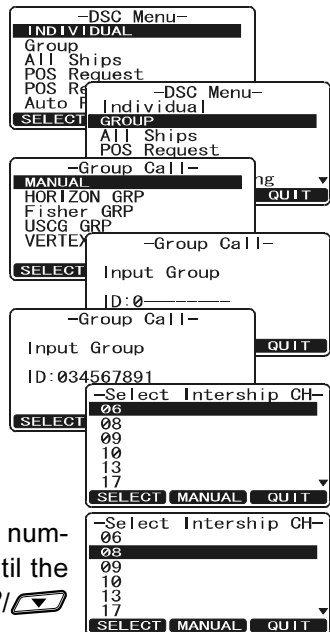
- Press the key. The “DSC Menu” will appear.
- Press the / key to select “GROUP”. (To cancel, press the **QUIT** soft key.)
- Press the **SELECT** soft key. The transceiver will beep, and the “Last Group Call” will appear.
- Select “MANUAL” with the / key.
- Press the **SELECT** soft key.
- Press the / key to select the first number of the MMSI (nine digits: first digit permanently set to “0”) which you want to contact, then press the **SELECT** soft key to step to the next number.
- Repeat step 6 to set the MMSI number.
- If a mistake was made entering in the MMSI number, repeat pressing the **BACK** soft key until the wrong number is selected, then press the / key to correct the entry.



9. When finished entering the MMSI number, press and hold the **SELECT** soft key.
10. Press the  key to select the operating channel you want to communicate on, then press the **SELECT** soft key. If the channel you want is not shown, press the **MANUAL** soft key, then press the  key to select the operating channel you want to communicate on, then press the **SELECT** soft key.
11. Press the **YES** soft key to transmit the Group Call signal.
12. After the Group Call is transmitted, all the radios in the group will switch to the designated channel.
13. Listen to the channel to make sure it is not busy, then press the **PTT** button and talk into the microphone to the group of vessels.

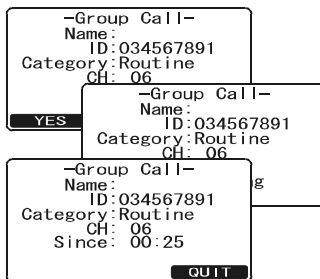

9.7.3 Receiving a Group Call

1. When a group call is received, the **GX1600** will produce a ringing alarm sound.
2. The display shows the GROUP MMSI number.
3. Press the any key to stop the alarm.
4. Monitor the channel for the person calling the Group for a message.

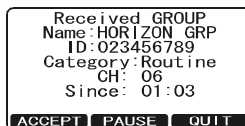

On the display you will notice 3 soft key selections. These selections are described below:

- a. **ACCEPT**: Accept to auto switching to Channel 16.
- Note:** If a key is not pressed for 30 seconds or longer the radio will automatically select Channel 16.
- b. **PAUSE**: Temporarily suspend switching to channel 16.
 - c. **QUIT**: Exit to the working channel.
5. If you want to respond, monitor the channel to make sure it is clear, then press the microphone's **PTT** switch and talk into the microphone to the group of vessels.
 6. Press the **QUIT** soft key to return to radio operation.

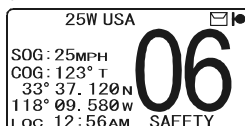
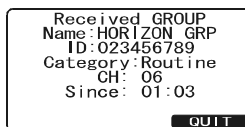

9.8 POSITION REQUEST



Advancements in DSC have made it possible to poll the location of another vessel and show the position of that vessel on the display of the **GX1600**. Standard Horizon has taken this feature one step further, if any compatible GPS chart plotter is connected to the **GX1600**, the polled position of the vessel is shown on the display of the GPS chart plotter making it easy to navigate to the location of the polled vessel. This is a great feature for anyone wanting to know the position of another vessel. For example your buddy that is catching fish, or finding the location of a person you are cruising with.

NOTE

The other vessel must have an operating GPS receiver connected to its DSC radio and must not have its radio set not to deny position requests. (Refer the section “**10.5 INDIVIDUAL CALL**” to enter information into the individual directory).

9.8.1 Position Reply Setup



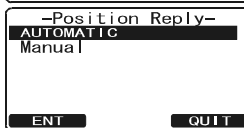
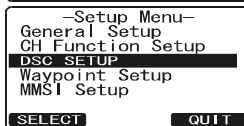
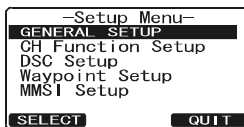

The **GX1600** can be set up to automatically (default setting) or manually send your position when requested by another vessel. This selection is important if you are concerned about someone polling the position of your vessel that you may not want to. In the manual mode you will see the MMSI or persons name shown on the display allowing you to choose to send your position to the requesting vessel.

1. Press and hold down the  key until “Setup Menu” appears.
2. Press the  key to select “DSC SETUP” menu.
3. Press the **SELECT** soft key, then select “POSITION REPLY” with the  key.
4. Press the **SELECT** soft key, then select “AUTOMATIC” or “MANUAL”. In “AUTOMATIC” mode, after a DSC POS Request is received, the radio will automatically transmit your vessels position. In “MANUAL” mode, the display of the **GX1600** will show who is requesting the position and the YES soft key on radio has to be pressed to send your position to the requesting.
5. Press the **ENT** soft key to store the selected setting.
6. Press the **QUIT** soft key several times to return to radio operation.



9.8.2 Position Request Ringer Setup

The **GX1600** has the capability to turn off the Position Request ringer.



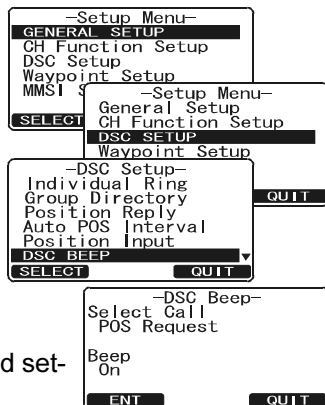

1. Press and hold down the  key until "Setup Menu" appears.
2. Press the  key to select "DSC SETUP" menu.
3. Press the **SELECT** soft key, then select "DSC BEEP" with the  key.
4. Press the **SELECT** soft key, then select "Off" with the  key.
5. Press the **ENT** soft key, then select "Off" with the  key.
6. Press the **ENT** soft key to store the selected setting.
7. Press the **QUIT** soft key several times to return to radio operation.



To re-enable the ringer tone, repeat the above procedure, pressing the  key to select "On" in step "5" above.

9.8.3 Transmitting a Position Request to Another Vessel

9.8.3.1 Position Request using the Individual Directory

1. Press the  key. The "DSC Menu" will appear.
2. Press the  key to select "POS REQUEST", then press the **SELECT** soft key.
3. Press the  key to select a name that was stored in the Individual DSC directory, then press the **SELECT** soft key.
4. Press the  key to select the nature of call ("ROUTINE" or "SAFETY"), then press the **SELECT** soft key.
5. Press the **YES** soft key to transmit the Position Request DSC call.
6. When the **GX1600** receives the position from the polled vessel it is shown on the radio display and also transferred to a GPS Chart plotter with NMEA DSC and DSE sentences.
7. Press the **QUIT** soft key to return to radio operation.

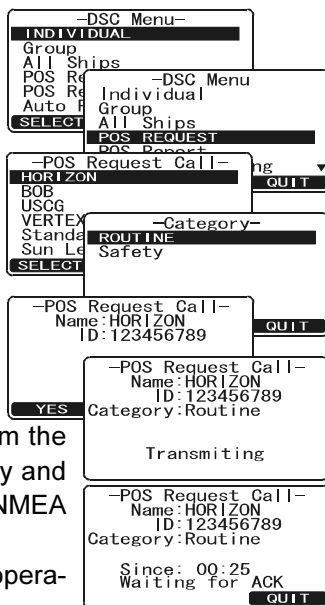

NOTE

If the **GX1600** does not receive a position data from the polled vessel, the display will show “NO POSITION DATA.”

9.8.3.2 Position Request by Manually Entering a MMSI

This feature allows you to request the position of vessel by manually entering the MMSI of the ship you want to send your position to.

1. Press the **CALL MENU** key. The “DSC Menu” will appear.
2. Press the **▲/▼** key to select “POS REQUEST”.
3. Press the **SELECT** soft key to show the “Last Individual Call”.
4. Press the **▲/▼** key to select the “MANUAL,” then press the **SELECT** soft key.
5. Press the **▲/▼** key to select the first number of the MMSI (nine digits) which you want to contact, then press the **SELECT** soft key to step to the next number.
6. Repeat step 5 to set the MMSI number.
7. If a mistake was made entering in the MMSI number, repeat pressing the **BACK** soft key until the wrong number is selected, then press the **▲/▼** key to correct the entry.
8. When finished entering the MMSI number, press and hold the **SELECT** soft key.
4. Press the **▲/▼** key to select the nature of call (“ROUTINE” or “SAFETY”), then press the **SELECT** soft key.
9. Press the **YES** soft key to transmit the position request DSC call.
10. When the **GX1600** receives the position from the polled vessel it is shown on the radio display and also transferred to the GPS Chart plotter with NMEA DSC and DSE sentences.
11. Press the **QUIT** soft key to return to radio operation.

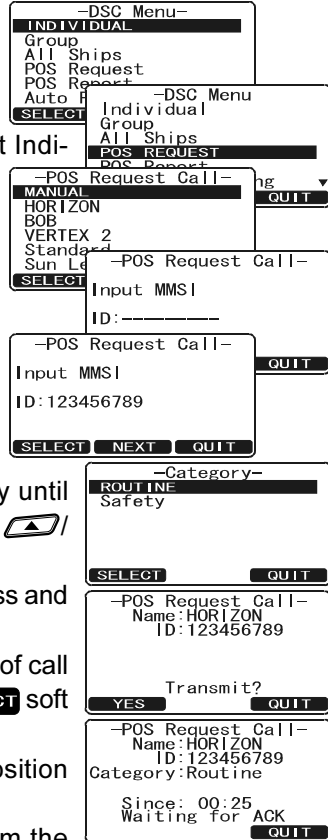

9.8.4 Receiving a Position Request

When a position request call is received from another vessel, a ringing alarm sounds and POS REQUEST will be shown in the display. Operation and transceiver function differs depending on “Position Reply” in the “DSC Setup” menu.

Automatically reply:

1. When a position request call is received, a calling alarm sounds 4 times. Then requested position coordinates are transmitted automatically to the vessel requesting your vessels position.
2. To exit from position request display, press the **QUIT** soft key.

```
Received POS Request
Name: Horizon
ID: 123456789
Category: Routine
Since: 01:03
QUIT
```

Manually reply:

1. When a position request call is received from another vessel, the display will be as shown in the illustration at the right.
2. A ringing alarm sounds 2 minutes. To send your vessels position to the requesting vessel, press the **REPLY** soft key. Or to exit from position request display, press the **QUIT** soft key.

```
Received POS Request
Name: Horizon
ID: 123456789
Category: Routine
Since: 01:03
REPLY QUIT
```

```
Received POS Request
Name: Horizon
ID: 123456789
Category: Routine
Since: 01:03
Transmitted
QUIT
```

9.9 POSITION REPORT











The feature is similar to Position Request, however instead of requesting a position of another vessel this function allows you to send your position to another vessel. Your vessel must have an operating GPS receiver connected for the **GX1600** to send the position.

NOTE

To transmit a Position Report Call, a GPS must be connected to the radio and the **GX1600** Individual directory must be programmed with stations you wish to send your position to. To setup this directory refer to section “9.5.1 Setting up the Individual / Position Call Directory.”

9.9.1 Position Report Ringer Setup

The **GX1600** has the capability to turn off the Position Report ringer.



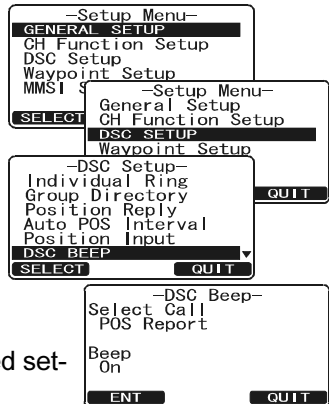





1. Press and hold down the  key until “Setup Menu” appears.
2. Press the  key to select “DSC SETUP” menu.
3. Press the  soft key, then select “DSC BEEP” with the  key.
4. Press the  soft key, then select “POS Report” with the  key.
5. Press the  soft key, then select “Off” with the  key.
6. Press the  soft key to store the selected setting.
7. Press the  soft key several times to return to radio operation.



To re-enable the ringer tone, repeat the above procedure, pressing the  key to select “On” in step “5” above.

9.9.2 Transmitting a DSC Position Report Call

9.9.2.1 DSC Position Report Call using the Individual Directory

1. Press the  key. The “DSC Menu” will appear.
2. Press the  key to select “POS REPORT”.
(To cancel, press the  soft key.)
3. Press the  soft key.
4. Press the  key to select the name in the directory, then press the  soft key.
5. Press the  key to select the nature of call (“ROUTINE” or “SAFETY”), then press the  soft

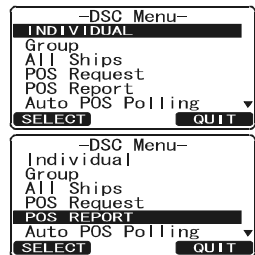

- key.
- Press the **YES** soft key to send your position to the selected vessel.
- Press the **QUIT** key to return to radio operation.

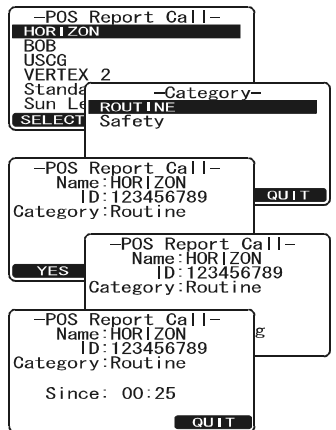

9.9.2.2 DSC Position Report Call by Manually Entering a MMSI

This feature allows you to send your position to another vessel by manually entering the MMSI of the ship you want to send your position to.

- Press the **CALL MENU** key. The “DSC Menu” will appear.
- Press the **▲/▼** key to select “POS REPORT”. (To cancel, press the **QUIT** soft key.)
- Press the **SELECT** soft key. The transceiver will beep, and the “Position Report Call” menu will appear.
- Press the **▲/▼** key to select “MANUAL”, then press the **SELECT** soft key.
- Press the **▲/▼** key to select the first number of the MMSI which you want to contact, then press the **SELECT** soft key to step to the next number.
- Repeat step 5 to set the MMSI number.
- If a mistake was made entering in the MMSI number, repeat pressing the **BACK** soft key until the wrong number is selected, then press the **▲/▼** key to correct the entry.
- When finished entering the MMSI number, press and hold the **SELECT** soft key.
- Press the **▲/▼** key to select the nature of call (“ROUTINE” or “SAFETY”), then press the **SELECT** soft key.
- Press the **YES** soft key to send your position to the selected vessel.

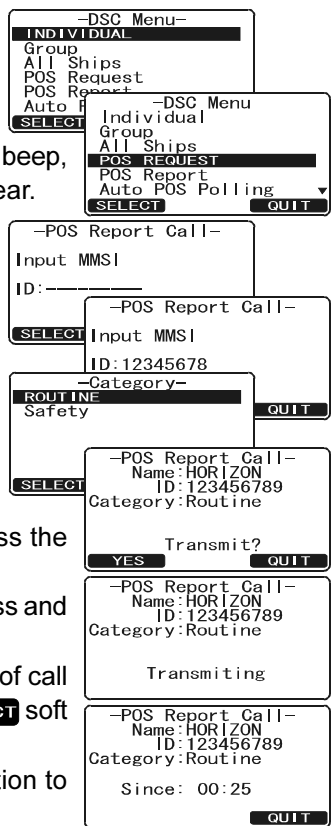

11. Press the **QUIT** soft key to return to radio operation.

9.9.3 Receiving a DSC Position Report Call

When another vessel transmits their vessels location to the **GX1600** the following will happen:

1. A ringing sound will be produced when the call is received and NMEA sentences DSC, DSE are outputted so the position can be shown on a chart plotter or a computer.
2. Press the any key to stop ringing.
3. Press the  key to see position information of the station.
4. To exit to radio mode, press the **QUIT** soft key.

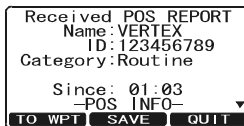

9.9.4 Navigating to a Position Report

The **GX1600** has a feature that allows navigation to a received Position Report call by using the Compass display. Navigating to the location of a Position Report call may be enabled by the procedure below.

1. After the Position Report call has been received: press the **TO WPT** soft key.
2. To start navigating using the compass display, press and hold the **ENT** soft key until the Compass Page is shown. The display indicates the distance and direction of the received vessel, and the compass indicates the received vessel by a dot (●) icon.

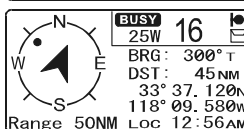
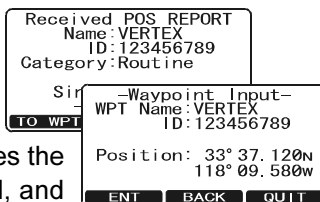

9.9.5 Stop Navigating to Position Report

To stop navigating to a waypoint, press the one of the Soft keys, then press the **STOP** soft key. The radio is switched to Normal Mode.

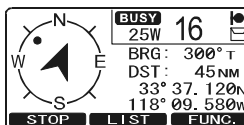

9.9.6 Saving a Position Report Call as a Waypoint

The **GX1600** can save a Position Report call in the radios memory as a waypoint.

1. After the Position Report call has been received:
Press the **SAVE** soft key.
2. Press the **▲/▼** key to change the first letter in the name of the waypoint and press the **ENT** soft key.
3. Repeat step 2 until the WPT Name is entered.
4. Press and hold the **ENT** soft key to save the waypoint into memory.

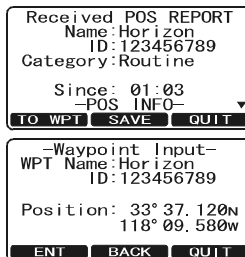

9.9.7 Navigating to a Saved Waypoint

1. Press and hold down the **CALL MENU** key until "Setup Menu" appears.
2. Select "GENERAL SETUP" with the **▲/▼** key.
3. Press the **SELECT** soft key, then select "DISPLAY" with the **▲/▼** key.
4. Press the **▲/▼** key to select "WAYPOINT" and press the **ENT** soft key.
5. Press the **▲/▼** key to select the waypoint name and press the **ENT** soft key.
6. Press the **ENT** key so show the compass display and to navigate to the waypoint. The display indicates the distance and direction of the saved waypoint, and the compass indicates the saved waypoint by a dot (●) icon.

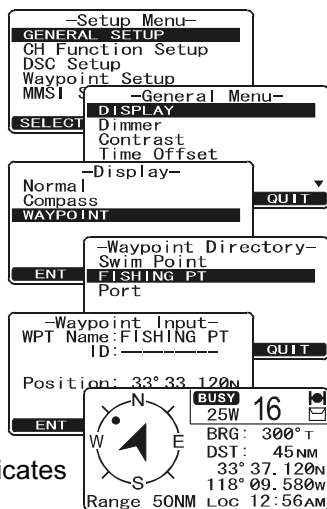

9.10 MANUAL INPUTTING A GPS POSITION (LAT/LON)

This selection allows the Latitude/Longitude of your vessel to be manually entered so DSC Distress or a Position Report call will contain position information. This feature maybe useful when a connected GPS fails to supply position to the radio.

1. Press and hold down the **CALL MENU** key until "Setup Menu" appears, then select "GENERAL SETUP" with the **▲/▼** key.
2. Press the **SELECT** soft key, then select "POSITION INPUT" with the **▲/▼** key.
3. Press the **SELECT** soft key. The transceiver will beep, and the display will be as shown in the illustration on the right.
4. Enter the latitude/longitude of your vessel and your local UTC time in the 24-hour notation by the **▲/▼** key. Press the **▲/▼** key to select the number and press the **ENT** soft key to move the cursor to the next character. You may backspace the cursor by pressing the **BACK** soft key, if you make a mistake.
5. To store the data entered, press and hold the **ENT** soft key.
6. Press the **QUIT** soft key several times to return to radio operation.

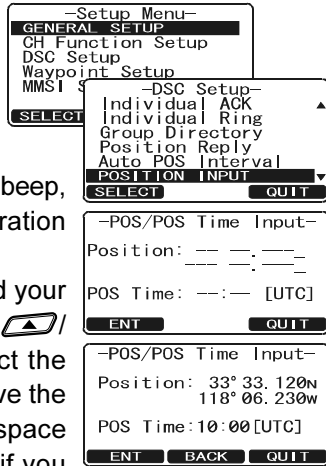

9.11 AUTO POS POLLING

The **GX1600** has the capability to automatically track four stations programmed into the Individual directory.

9.11.1 Polling Time Interval Setup

The following steps allows the radio to setup the interval time between DSC Position Request Transmissions.

1. Press and hold down the **CALL MENU** key until "Setup Menu" appears.
2. Press the **▲/▼** key to select "DSC SETUP" menu.
3. Press the **SELECT** soft key, then select "AUTO POS INTERVAL" with the **▲/▼** key.
4. Press the **▲/▼** key to select the desired interval time (1, 2, 3, 4, 5, 10, 20, 30, and 40 minutes) and press the **ENT** soft key.
5. Press the **QUIT** soft key numerous times to exit to the radio mode.

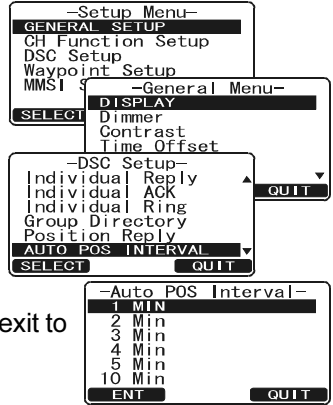

9.11.2 Selecting Stations to be Automatically Polled (tracked)

NOTE

The radio uses the Individual directory to select stations. Refer to section "9.5.1 Setting up the Individual / Position Call Directory" and to enter MMSI of stations you want to poll before proceeding.

1. Press the **CALL MENU** key. The "DSC Menu" will appear.
2. Press the **▲/▼** key to select "AUTO POS POLLING", then press the **SELECT** soft key.
3. Press the **▲/▼** key to select the "SELECT ADDRESS", then press the **SELECT** soft key.
4. The radio will show 4 calling stations to be selected, select "CALL 1" and press the **SELECT** soft key.
5. The radio will show the stations programmed in the Individual directory. Press the **▲/▼** key to select the desired station and press the **SELECT** soft key.

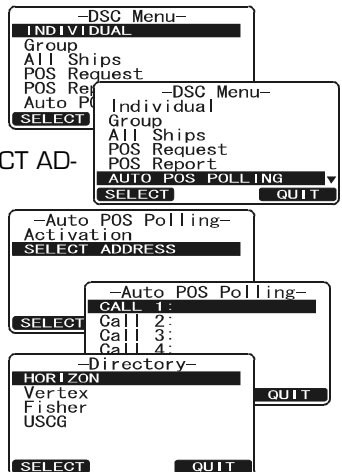

- Repeat steps 4 and 5 for CALL 2, CALL 3 and CALL 4 entries.
- When finished, press the **QUIT** soft key numerous times to exit to the radio mode.

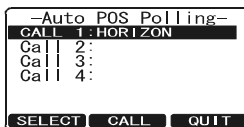

9.11.3 Enable/Disable Auto POS Polling

- Press the **CALL MENU** key. The “DSC Menu” will appear.
- Press the **▲/▼** key to select “AUTO POS POLLING”, then press the **SELECT** soft key.
- Press the **▲/▼** key to select the “ACTIVATION”, then press the **SELECT** soft key.
- Select “START” to enable transmissions to the stations or “STOP” to disable transmissions to stations.
- Press the **ENT** soft key.
- Press the **QUIT** soft key numerous times to exit to the radio mode.

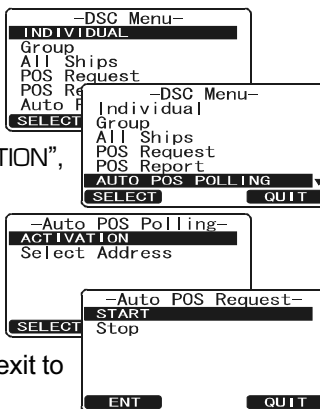

NOTE

When the radio receives position reports from a called vessel the display will show the image to the right also NMEA 0183 DSC and DSE sentences are outputted to a connected GPS Chart Plotter or PC.

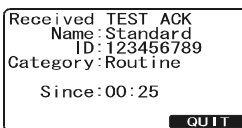

9.12 DSC TEST

This function is used to contact another DSC equipped vessel to ensure the DSC functions of the radio are operating.

NOTE

To use this feature, the radio you will be transmitting the test call to needs to have the DSC Test feature.

To perform the DSC test you will need to enter a MMSI of another vessel into the Individual directory or manually enter in the MMSI using the procedure below.

9.12.1 Programming MMSI into Individual Directory

Refer to section “9.5.1 Setting up the Individual / Position Call Directory”.

9.12.2 DSC Test Call by using Individual Directory

1. Press the **CALL MENU** key. The “DSC Menu” will appear.
2. Press the **▲/▼** key to select “DSC TEST”, then press the **SELECT** soft key.
3. Press the **▲/▼** key to select the Ship name and press the **SELECT** soft key.
4. Press the **YES** soft key to transmit the DSC test call to the other vessel.

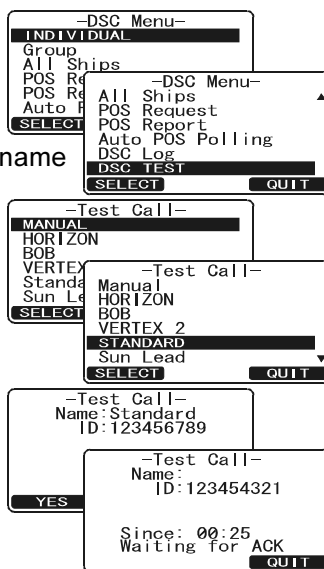

NOTE

After the radio receive a Test Call reply from vessel that was called, the radio will ring and show TEST ACK display, which confirms the radio you called received the test call.

Received AN ACKNOWLEDG
Name:
ID: 123456789
Category: Routine
Since: 00:25
QUIT

9.12.3 DSC Test Call by Manually Entering a MMSI

1. Press the **CALL MENU** key. The "DSC Menu" will appear.
2. Press the **▲/▼** key to select "DSC TEST", then press the **SELECT** soft key.
3. Press the **▲/▼** key to select "MANUAL" and press the **SELECT** soft key.
4. Press the **▲/▼** key to select the first digit in the MMSI and press the **SELECT** soft key.
5. Repeat step 4 until all the numbers of the MMSI are shown on the display.
6. Press and hold the **SELECT** soft key to show the Test Call page.
7. Press the **YES** soft key to transmit the DSC Test Call to the other vessel.

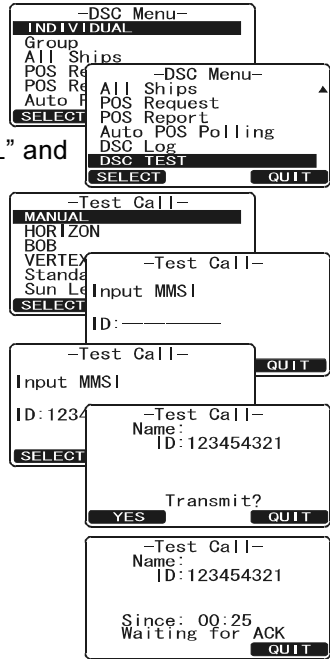

NOTE

After the radio receive a Test Call reply from vessel that was called, the radio will ring and show TEST ACK display, which confirms the radio you called received the test call.

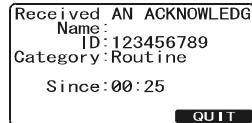

10 GENERAL SETUP

The optional **RAM3 (CMP30)** Remote Station Microphone can also adjust items in the setup menu using the following procedures.

10.1 DISPLAY

The **GX1600** can select additional screens other than the default “NORMAL” (Radio) Display by using the procedure below.

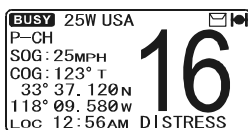

“NORMAL” DISPLAY

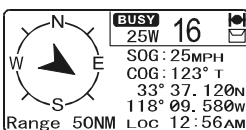

“COMPASS” DISPLAY

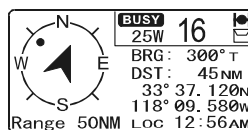



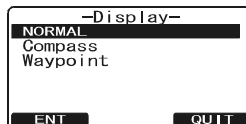
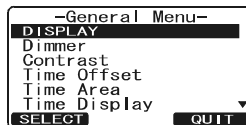
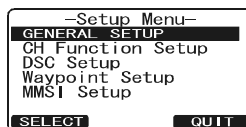

“WAYPOINT” DISPLAY

1. Press and hold down the **CALL MENU** key until “Setup Menu” appears, then select “GENERAL SETUP” with the **▲/▼** key.
2. Press the **SELECT** soft key, then press the **▲/▼** key to select “DISPLAY”.
3. Press the **SELECT** soft key.
4. Press the **▲/▼** key to select desired screen type “NORMAL”, “COMPASS”, or “WAYPOINT”.
5. Press the **ENT** soft key to store the selected setting.
6. Press the **QUIT** soft key several times to return to radio operation.



10.2 DIMMER ADJUSTING



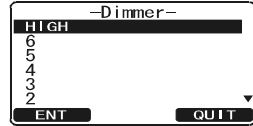
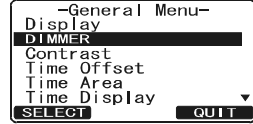

This menu selection adjusts the backlight intensity of the display and keypad.

1. Press and hold down the  key until "Setup Menu" appears, then select "GENERAL SETUP" with the  key.
2. Press the **SELECT** soft key, then press the  key to select "DIMMER".
3. Press the **SELECT** soft key, then press the  key to select the desired level ("HIGH" is default). When "OFF" is selected, the lamp is turned off.
4. Press the **ENT** soft key to store the selected level.
5. Press the **QUIT** soft key several times to return to radio operation.



10.3 CONTRAST

This selection sets up the display contrast for overhead or dash installations.

1. Press and hold down the  key until "Setup Menu" appears, then select "GENERAL SETUP" with the  key.
2. Press the **SELECT** soft key, then press the  key to select "CONTRAST".
3. Press the **SELECT** soft key.
4. Press the  key to select the desired level. The contrast level can be set from "0" to "31".
5. Press the **ENT** soft key to store the selected level.
6. Press the **QUIT** soft key several times to return to radio operation.

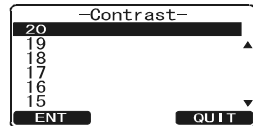
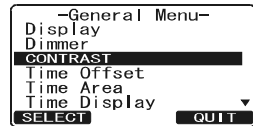
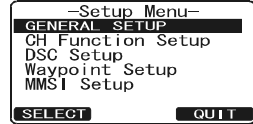

10.4 TIME OFFSET

Sets the time offset between local time (with inputted offset) and UTC (without time offset) shown on the display. Time is displayed only when an optional GPS Chart Plotter is connected.



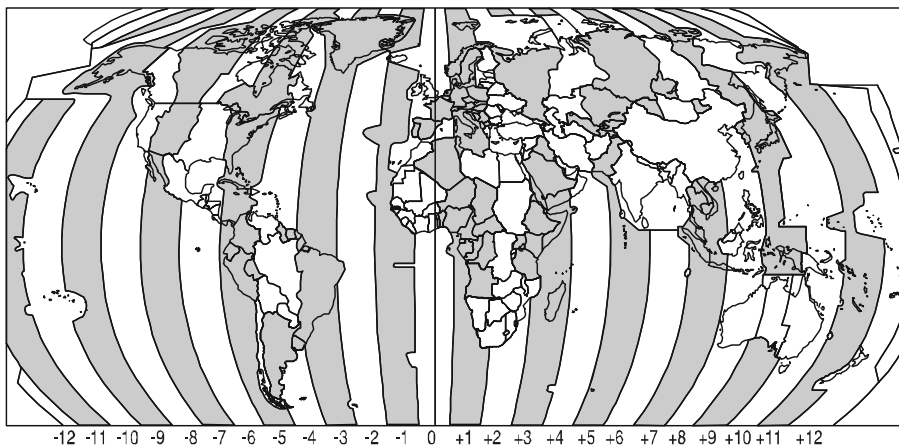
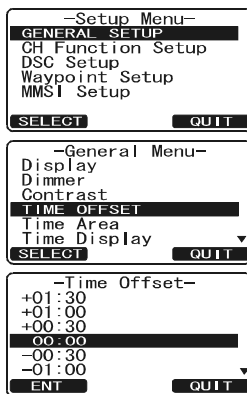





1. Press and hold down the **CALL MENU** key until "Setup Menu" appears, then select "GENERAL SETUP" with the **▲/▼** key.
2. Press the **SELECT** soft key, then press the **▲/▼** key to select "TIME OFFSET".
3. Press the **SELECT** soft key, then press the **▲/▼** key to select time offset of your location. See illustration below to find your offset time. If "00:00" is assigned, the time is the same as UTC (Universal Time Coordinated or GPS Satellite Time).
4. Press the **ENT** soft key to store the time offset.
5. Press the **QUIT** soft key several times to return to radio operation.



UTC/GMT
OFFSET TIME TABLE

10.5 TIME AREA









This menu selection allows the radio to show UTC time or local time with the offset.

1. Press and hold down the  key until "Setup Menu" appears, then select "GENERAL SETUP" with the  key.
2. Press the  soft key, then press the  key to "TIME AREA".
3. Press the  soft key.
4. Press the  key to select "UTC" or "LOCAL".
5. Press the  soft key to store the selected setting.
6. Press the  soft key several times to return to radio operation.



10.6 TIME DISPLAY

This menu selection allows the radio to show time in 12-hour or 24-hour format.

1. Press and hold down the  key until "Setup Menu" appears, then select "GENERAL SETUP" with the  key.
2. Press the  soft key, then press the  key to select "TIME DISPLAY".
3. Press the  soft key.
4. Press the  key to select "12 HOUR" or "24 HOUR".
5. Press the  soft key to store the selected setting.
6. Press the  soft key several times to return to radio operation.

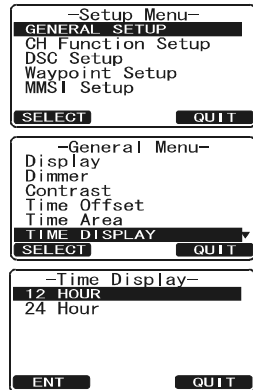





10.7 UNIT OF MEASURE

Allows Navigation and AIS displays to be shown in “Knot”, “Mile/Hour” or “Kilo-Meter/Hour” (for speed) and “Nautical Mile” or “Kilo-Meter” (for distance).

NOTE

A GPS must be connected to the radio to be able to show SPEED and DISTANCE.

1. Press and hold down the  key until “Setup Menu” appears, then select “GENERAL SETUP” with the  key.
2. Press the **SELECT** soft key, then press the  key to select “UNIT OF MEASURE”.
3. Press the **SELECT** soft key.
4. Press the  key to select “SPEED” or “DISTANCE” which you wish to change.
5. Press the **SELECT** soft key, then press the  key to select desired unit. Available selections are KTS (knot), MPH (Mile/Hour), or KMH (Kilo-Meter/Hour) for speed, and NM (Nautical Mile), SM (Statute Mile), or KM (Kilo-Meter) for distance.
6. Press the **ENT** soft key to store the selected setting.
7. Press the **QUIT** soft key several times to return to radio operation.

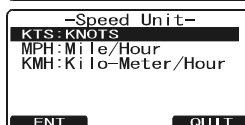
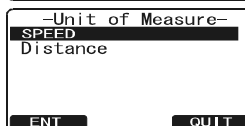
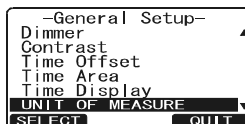
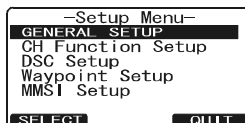





10.8 MAGNETIC

This selection allows customizing the GPS COG (Course Over Ground) displayed in True or Magnetic.

NOTE



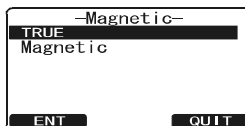
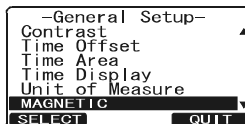
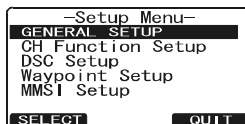

A GPS must be connected to the radio to be able to show COG.

1. Press and hold down the  key until "Setup Menu" appears, then select "GENERAL SETUP" with the  key.
2. Press the **SELECT** soft key, then press the  key to select "MAGNETIC".
3. Press the **SELECT** soft key.
4. Press the  key to select "TRUE" or "MAGNETIC".
5. Press the **ENT** soft key to store the selected setting.
6. Press the **QUIT** soft key several times to return to radio operation.



10.9 KEY BEEP





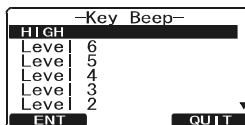
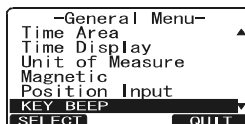
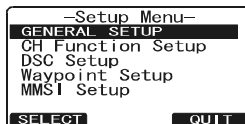

This selection is used to select the beep tone volume level when a key is pressed.

1. Press and hold down the  key until "Setup Menu" appears, then select "GENERAL SETUP" with the  key.
2. Press the **SELECT** soft key, then press the  key to select "KEY BEEP".
3. Press the **SELECT** soft key.
4. Press the  key to select the desired level. The beep level can be set from "LEVEL 1" to "LEVEL 6", "HIGH", or "OFF".
5. Press the **ENT** soft key to store the selected level.
6. Press the **QUIT** soft key several times to return to radio operation.



10.10 STATION NAME

This function allows you to change the name of the radio or **RAM3** second station microphone. Example: "Radio - Cabin", "RAM1 - Flybridge".

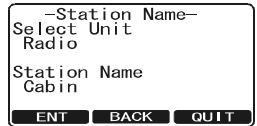
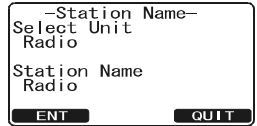
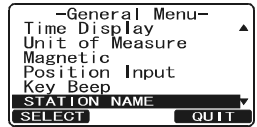
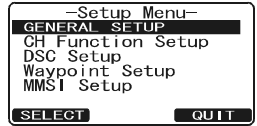

1. Connect the **RAM3** second station microphone to the **GX1600**.
2. Press and hold down the  key until "Setup Menu" appears, then select "GENERAL SETUP" with the  key.
3. Press the **SELECT** soft key, then press the  key to select "STATION NAME".
4. Press the **SELECT** soft key.
5. Press the  key to select the Unit ("Radio" or "RAM1") to be named, then press the **ENT** soft key.
6. Press the  key to scroll through the first letter of the new channel name.
7. Press the **ENT** soft key to store the first letter in the name and step to the next letter to the right.
8. Repeat step 6 and 7 until the name is complete. The name can consist of up to 8 characters, if you do not use all 8 characters press the **ENT** soft key to move to the next space. This method can also be used to enter a blank space in the name. If a mistake was made entering in the name repeat pressing the **BACK** key until the wrong character is selected, then press the  key to correct the entry.
9. Press and hold the **ENT** soft key to enter the name.
10. If you want to enter the name of the connected **RAM3** or Radio, repeat steps 5 through 9.
11. Press the **QUIT** soft key several times to return to radio operation.



10.11 SOFT KEYS





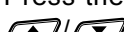
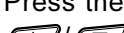

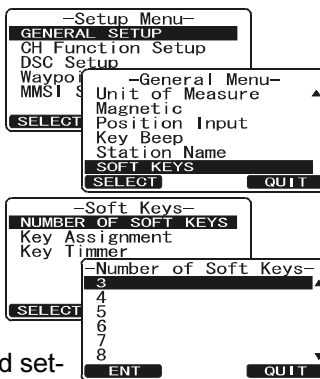
This menu item assigns the number of soft keys, soft key selection and how long the display will show the soft key icon after a soft key is pressed.

10.11.1 Selecting the Number of Soft Keys

1. Press and hold down the  key until "Setup Menu" appears, then select "GENERAL SETUP" with the  key.
2. Press the **SELECT** soft key, then press the  key to "SOFT KEYS".
3. Press the **SELECT** soft key, then press the  key to "NUMBER OF SOFT KEYS".
4. Press the **SELECT** soft key, then press the  key to select the number of soft keys (3 through 10).
5. Press the **ENT** soft key to store the selected setting.
6. Press the **QUIT** soft key several times to return to radio operation.

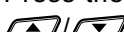

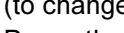
10.11.2 Assigning Soft Keys

1. Press and hold down the  key until "Setup Menu" appears, then select "GENERAL SETUP" with the  key.
2. Press the **SELECT** soft key, then press the  key to "SOFT KEYS".
3. Press the **SELECT** soft key, then press the  key to select "KEY ASSIGNMENT" (to change the use of selected soft keys).
4. Press the **SELECT** soft key, then press the  key to select the key ("KEY1", "KEY2", or "KEY3").
5. Press the **SELECT** soft key, then press the  key to select the new function to be assigned, and press the **SELECT** soft key. Available functions are listed below.

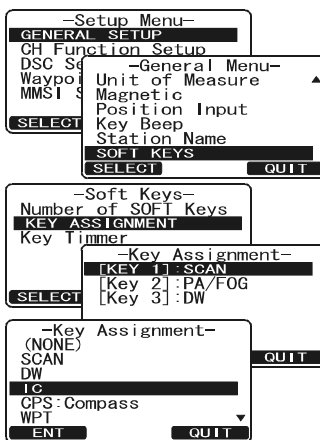

DISPLAY	FUNCTION
SCAN	Starts and stops Scanning.
DW	Starts and stops Dual Watch Scan.
IC	Activates Intercom between radio and RAM3 mic (optional RAM3 required).
CMP: COMPASS	Shows to the "Compass" display.
WPT	Shows to the "Waypoint" Navigation display.
PRESET	Saves or deletes the preset memory channel.
WX	Immediately recalls the last select the weather channel.
MARK	Marks the current position for a "Waypoint".
PRESET 0 - 9	Immediately recalls the Preset Memory Channel.

- Repeat steps 4 and 5 to program the other soft keys. The factory defaults are Key 1: **SCAN**, Key 2: **DW**, and Key 3: **WX** function.
- Press the **ENT** soft key to store the selected setting.
- Press the **QUIT** soft key several times to return to radio operation.

10.11.3 Selecting How Long the Soft Keys are Shown

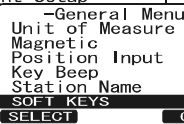
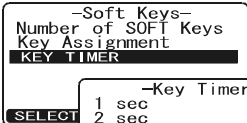
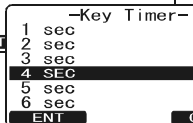



- Press and hold down the **CALL MENU** key until "Setup Menu" appears, then select "GENERAL SETUP" with the **▲/▼** key.
 
- Press the **SELECT** soft key, then press the **▲/▼** key to "SOFT KEYS".
 
- Press the **SELECT** key, then press the **▲/▼** key to select "KEY TIMER" (selects how long the soft key icon will be shown on the display after a soft key is pressed, default is 4 seconds). Then, press the **SELECT** soft key.
 
- Press the **▲/▼** key to select the time.
 
- Press the **ENT** soft key to store the selected setting.
- Press the **QUIT** soft key several times to return to radio operation.

11 CHANNEL FUNCTION SETUP

11.1 CHANNEL GROUP

(USA, CANADA or INTERNATIONAL BAND SELECTION)



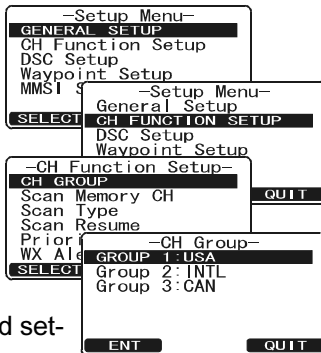

This section selects a channel group from USA, Canada, and International.

1. Press and hold down the  key until "Setup Menu" appears.
2. Press the  key to select "CH FUNCTION SETUP".
3. Press the **SELECT** soft key, then press the  key to select "CH GROUP".
4. Press the **SELECT** soft key.
5. Press the  key to select desired channel group "USA", "INTL", or "CANADA".
6. Press the **ENT** soft key to store the selected setting.
7. Press the **QUIT** soft key several times to return to radio operation.



11.2 SCAN MEMORY





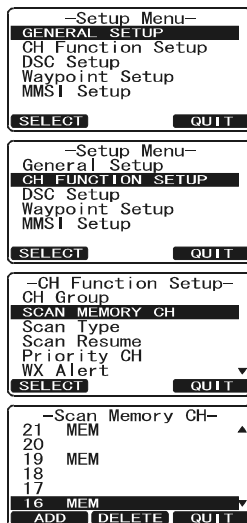



To be able to scan channels the radio must be programmed. This section allows channels to be stored in scan memory.

1. Press and hold down the  key until "Setup Menu" appears.
2. Press the  key to select "CH FUNCTION SETUP".
3. Press the **SELECT** soft key, then press the  key to select "SCAN MEMORY CH".
4. Press the **SELECT** soft key.
5. Press the  key to select a desired channel to be scanned, then press the **ADD** key. "MEM" icon appears on the display, which indicates the channel has been selected to the scan channel.
6. Repeat step 5 for all the desired channels to be scanned.
7. To DELETE a channel from the list, select the channel then press the **DELETE** key. "MEM" icon disappears from the display.
8. When you have completed your selection, press the **QUIT** soft key several times to return to radio operation.



11.3 SCAN TYPE





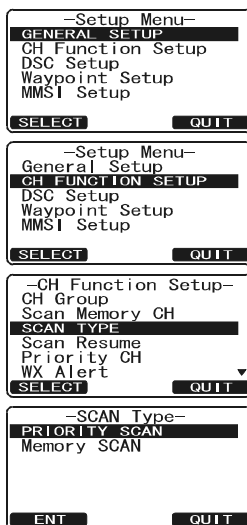



This selection is used to select the scan mode between “Memory Scan” and “Priority Scan”. The default setting is Priority Scan.

1. Press and hold down the  key until “Setup Menu” appears.
2. Press the  key to select “CH FUNCTION SETUP”.
3. Press the  soft key, then select “SCAN TYPE” with the  key.
4. Press the  soft key.
5. Press the  key to select “PRIORITY SCAN” or “MEMORY SCAN”.
6. Press the  soft key to store the selected setting.
7. Press the  soft key several times to return to radio operation.



11.4 SCAN RESUME





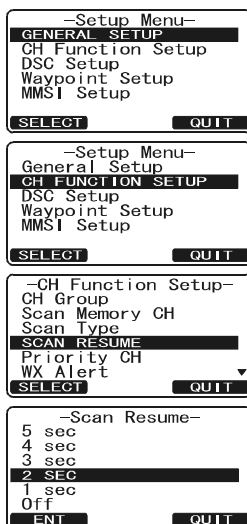



This selection is used to select the time the **GX1600** waits after a transmission ends before the radio start to scan channels again. The default setting is 2 seconds.

1. Press and hold down the  key until “Setup Menu” appears.
2. Press the  key to select “CH FUNCTION SETUP”.
3. Press the  soft key, then select “SCAN RESUME” with the  key.
4. Press the  soft key.
5. Press the  key to select the desired resume time, default is 2 seconds. The resume time can be set to “1SEC” through “5SEC”, or “OFF”. In the “OFF” selection, the scanner will resume after the other station stops transmitting (carrier drops).
6. Press the  soft key to store the selected setting.
7. Press the  soft key several times to return to radio operation.



11.5 PRIORITY CHANNEL





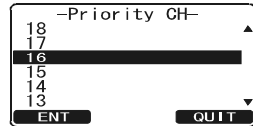
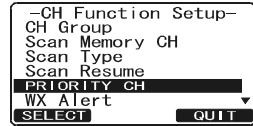
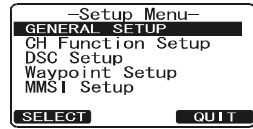



By default the radio priority channel is set to channel 16. This procedure allows the radio to use a different priority channel used when priority scanning.

1. Press and hold down the  key until "Setup Menu" appears.
2. Press the  key to select "CH FUNCTION SETUP".
3. Press the  soft key, then select "PRIORITY CH" with the  key.
4. Press the  soft key.
5. Press the  key to select the desired channel to be a priority.
6. Press the  soft key to store the selected setting.
7. Press the  soft key several times to return to radio operation.



11.6 WEATHER ALERT

This menu selection allows you to toggle the WX Alert "ON" or "OFF". The default setting is "ON".



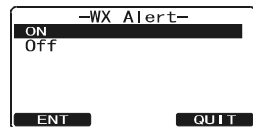
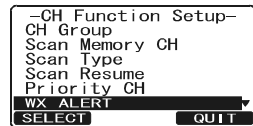
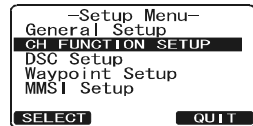
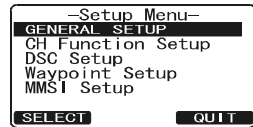











1. Press and hold down the  key until "Setup Menu" appears.
2. Press the  key to select "CH FUNCTION SETUP".
3. Press the  soft key, then select "WX ALERT" with the  key.
4. Press the  soft key.
5. Press the  key to select the desired WX alert mode. The WX alert mode can be set to "ON" or "OFF".
6. Press the  soft key to store the selected setting.
7. Press the  soft key several times to return to radio operation.



11.7 CHANNEL NAME

When radio mode (NORMAL) is selected, the display will show a name under the channel number. This name describes the use of the channel. The radio has the capability to customize the name by the procedure below.

Example: CH69 PLEASURE to HOOKUP

1. Press and hold down the  key until "Setup Menu" appears.
2. Press the  key to select "CH FUNCTION SETUP".
3. Press the  soft key, then select "CH NAME" with the  key.
4. Press the  soft key.
5. Press the  key to select the channel to be named, then press the  soft key.
6. Press the  key to scroll through the first letter of the new channel name.
7. Press the  soft key to store the first letter in the name and step to the next letter to the right.
8. Repeat step 6 and 7 until the name is complete. The name can consist of up to 16 characters, if you do not use all 16 characters press the  soft key to move to the next space. This method can also be used to enter a blank space in the name. If a mistake was made entering in the name repeat pressing the  key until the wrong character is selected, then press the  key to correct the entry.
9. Press and hold the  soft key to save the name.
10. If you want to enter the name of another channel, repeat steps 5 through 9.
11. Press the  soft key several times to return to radio operation.

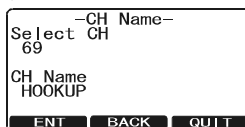
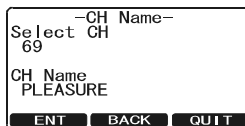
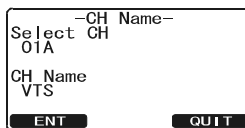
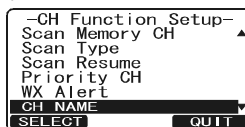
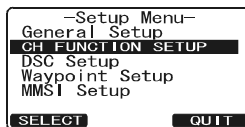
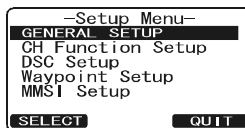

12 DSC SETUP

12.1 INDIVIDUAL DIRECTORY

The **GX1600** has a DSC directory that allows you to store a vessel or person's name and the MMSI number associated with vessels you wish to transmit Individual calls, Position Requests and Position Send transmissions.

To transmit an Individual call you must program this directory with information of the persons you wish to call, similar to a cellular phones telephone directory.

Refer to section "**9.5.1 Setting up the Individual / Position Call Directory**" for programming.

12.2 INDIVIDUAL REPLY

This menu item sets up the radio to automatically (default setting) or manually respond to a DSC Individual call requesting you to switch to a working channel for voice communications. When Manual is selected the MMSI of the calling vessel is shown allowing you to see who is calling. This function is similar to caller id on a cellular phone.

Refer to section "**9.5.2 Setting up Individual Reply**" for setting.

12.3 INDIVIDUAL ACKNOWLEDGMENT

The radio can be setup to transmit a reply automatically (default) or set so the radio will not reply to an individual call.

Refer to section "**9.5.3 Enabling the Individual Acknowledgment**" for setting.

12.4 INDIVIDUAL RINGER

The radio can be setup to ring like a telephone to alert you the radio received a DSC Individual call. The default setting is 2 minutes, however this can be changed to 15, 10 or 5 seconds.

Refer to section "**9.5.4 Setting up Individual/Group Call Ringer**" for setting.

12.5 GROUP DIRECTORY

For this function to operate, the same Group MMSI must be programmed into all the DSC VHF radios within the group of vessels that will be using this feature. To understand Group MMSI programming, first a Ship MMSI has to be understood.

Refer to section "**9.7.1 Setup a Group Call**" for programming.

12.6 POSITION REPLY

The **GX1600** can be set up to automatically (default setting) or manually send your position when requested by another vessel. This selection is important if you are concerned about someone polling the position of your vessel that you may not want to. In the manual mode you will see the MMSI or persons name shown on the display allowing you to choose to send your position to the requesting vessel.

Refer to section “**9.8.1 Setting up a Position Reply**” for setting.

12.7 AUTO POSITION INTERVAL





The **GX1600** has the capability to automatically track four stations programmed into the Individual directory.

Selecting Auto POS Polling time interval between position request transmissions to be setup.

Refer to section “**9.11 AUTO POS POLLING**” for setting.

12.8 DSC BEEP

This feature allows the alarm beeps to be turned on (default setting) or off when a DSC call is received. The DSC calls that can be customized are: Individual, Group, All Ships, Position Request, Position Report, Geographical Call using the procedure below:



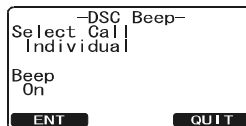
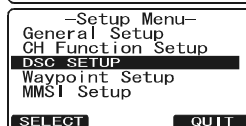
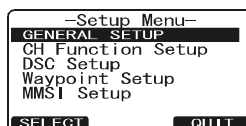

1. Press and hold down the  key until “Setup Menu” appears.
2. Press the  key to select “DSC SETUP” menu.
3. Press the **SELECT** soft key, then select “DSC BEEP” with the  key.
4. Press the **SELECT** soft key, then press the  key to the desired DSC call type and press the **ENT** soft key.
5. Press the  key to turn “On” or “Off” the DSC beep and press the **ENT** soft key.
6. Press the **QUIT** soft key several times to return to radio operation.



12.9 AUTO CHANNEL SWITCH TIME

When a DSC Distress or ALL Ships (Urgency or Safety) call is received, the **GX1600** will automatically switch to channel 16.

This menu selection allows the automatic switch time to be changed. The default selection is 30 seconds.

1. Press and hold down the  key until "Setup Menu" appears.
2. Press the  key to select "DSC SETUP" menu.
3. Press the **SELECT** soft key, then select "AUTO CH SWITCH TIME" with the  key.
4. Press the **SELECT** soft key, then press the  key to the desired time and press the **ENT** soft key.
5. Press the **QUIT** soft key several times to return to radio operation.

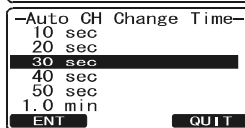
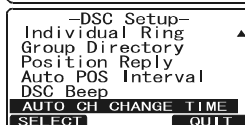
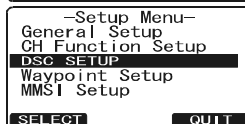
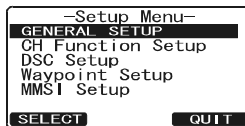





13 WAYPOINTS

The **GX1600** is capable of storing up to 100 waypoints and navigating to them using the compass page.

In addition DSC distress calls with position or a position received from another DSC radio using DSC polling can be navigated to.

13.1 MARKING A POSITION

This feature allows the radio to mark the current position of the vessel.



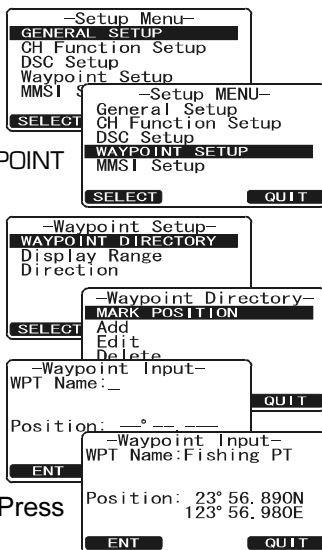



1. Press and hold down the  key until "Setup Menu" appears.
2. Press the  key to select "WAYPOINT SETUP".
3. Press the **SELECT** soft key, then select "WAYPOINT DIRECTORY" with the  key.
4. Press the **SELECT** soft key, then select "MARK POSITION" with the  key.
5. Press the **SELECT** soft key, then enter the Waypoint Name, by pressing the  key to select the first letter.
6. Press the **ENT** soft key to store the first letter and to move to the second letter in the name.
7. Repeat step 5 and 6 until the name is shown. Press the **ENT** soft key to skip a letter if needed.
8. Press and hold the **ENT** soft key two times to save the waypoint into memory.
9. Press the **QUIT** soft key several times to return to radio operation.



NOTE

One of the soft keys (refer to section "10.11 SOFT KEYS") may be assigned to Mark and when pressed will bring up the menu above.

13.2 ADDING A WAYPOINT

1. Press and hold down the  key until "Setup Menu" appears.
2. Press the  key to select "WAYPOINT SETUP".
3. Press the **SELECT** soft key, then select "WAYPOINT DIRECTORY" with the  key.
4. Press the **SELECT** soft key, then select "ADD" with the  key.
5. Press the **SELECT** soft key.
6. Enter the Waypoint Name, by pressing the  key to select the first letter.
7. Press the **ENT** soft key to store the first letter and to move to the second letter in the name.
8. Repeat step 6 and 7 until the name is shown. Press the **ENT** soft key to skip a letter if needed.
9. Press and hold the **ENT** soft key, then enter the coordinates of the waypoint POSITION, by pressing the  key to select the first digit in the Latitude.
10. Press the **ENT** soft key to store the first number and to move to the second number in the position.
11. Repeat step 9 and 10 until the latitude is shown include N or S in the last digit.
12. Press the **ENT** soft key to select the first digit of the Longitude is blinking.
13. Press the  key to select the first digit in the Longitude.
14. Press the **ENT** soft key to store the first number and to move to the second number in the position.
15. Repeat step 13 and 14 until the Latitude is shown include E or W in the last digit.
16. After all information is entered, press and hold the **ENT** soft key to store the waypoint into memory.
17. Press the **QUIT** soft key several times to return to radio operation.

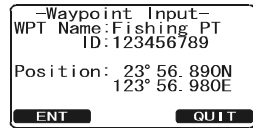
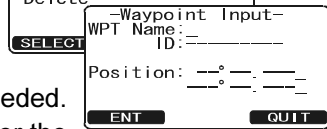
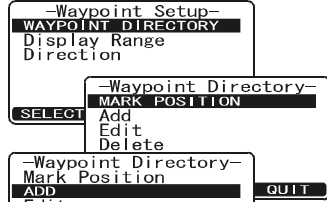
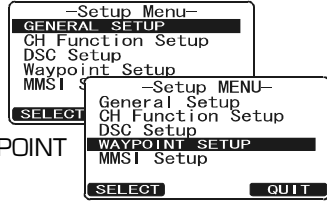

13.3 EDITING A WAYPOINT

This function allows a previously entered waypoint to be edited.

1. Press and hold down the **CALL MENU** key until "Setup Menu" appears.
2. Press the **▲/▼** key to select "WAYPOINT SETUP".
3. Press the **SELECT** soft key, then select "WAYPOINT DIRECTORY" with the **▲/▼** key.
4. Press the **SELECT** soft key, then select "EDIT" with the **▲/▼** key.
5. Press the **SELECT** soft key, then press the **▲/▼** key to select the waypoint to be edited.
6. Press the **ENT** soft key to show the waypoint Input display.
7. Press the **ENT** soft key repeatedly until the number or letter is selected that is to be changed.
8. Press the **▲/▼** key to change the letter or number.
9. Repeat step 7 and 8 until the waypoint is updated.
10. Press and hold the **ENT** soft key to store the edited waypoint into memory.
11. Press the **QUIT** soft key several times to return to radio operation.

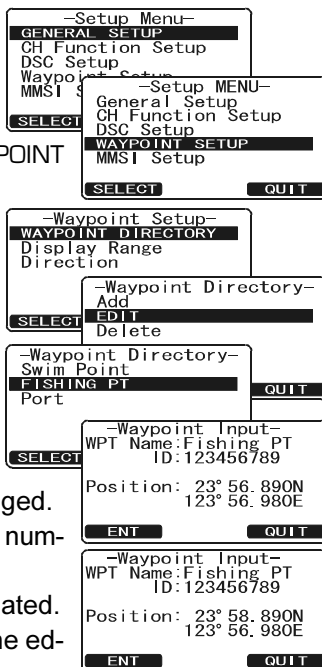

13.4 DELETING A WAYPOINT

1. Press and hold down the **CALL MENU** key until "Setup Menu" appears.
2. Press the **▲/▼** key to select "WAYPOINT SETUP".
3. Press the **SELECT** soft key, then select "WAYPOINT DIRECTORY" with the **▲/▼** key.
4. Press the **SELECT** soft key, then select "DELETE" with the **▲/▼** key.
5. Press the **SELECT** soft key, then press the **▲/▼** key to highlight the waypoint to be deleted.
6. Press and hold the **ENT** soft key until the radio beeps and the waypoint directory is removed from the display.
7. Press the **QUIT** soft key several times to return to radio operation.

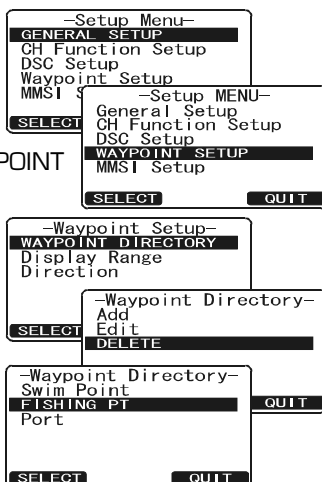

13.5 SAVING A DSC POSITION CALL AS A WAYPOINT

When a DSC POSITION REPORT call is received from a another DSC radio the **GX1600** allows the position to be saved as a waypoint.

1. After a position has been received, press the **SAVE** soft key.
2. The first digit in the WPT Name will be flashing, press the / key to the first letter of the name you want to input.
3. Press the **ENT** soft key, then press the / key to select the second letter in the name.
4. Repeat step 3 until the name is shown.
5. Press and hold the **ENT** soft key to save the waypoint to memory and return to radio operation.

```

Received POS REPORT
Name: Horizon
ID: 123456789
Category: Routine

Since: 01:03
-POS INFO-
TO WPT SAVE QUIT
    
```

```

-Waypoint Input-
WPT Name: Horizon
ID: 123456789

Position: 33° 37. 120N
118° 09. 580W

ENT BACK QUIT
    
```

```

-Waypoint Input-
WPT Name: Swim Point
ID: 123456789

Position: 33° 37. 120N
118° 09. 580W

ENT BACK QUIT
    
```

13.6 NAVIGATING TO A SAVED WAYPOINT

1. Press and hold down the key until "Setup Menu" appears.
2. Press the / key to select "GENERAL SETUP".
3. Press the **SELECT** soft key, then select "DISPLAY" with the / key.
4. Press the **ENT** soft key, and select "WAYPOINT", and press the **SELECT** soft key.
5. Select the waypoint name and press the **SELECT** soft key to show the waypoint data display.
6. Press the **ENT** soft key to start navigating the waypoint and show the Waypoint Nav display.

```

-Setup Menu-
GENERAL SETUP
CH Function Setup
DSC Setup
AIS/Compass Setup
Waypoint
MMSI S
SELECT
    
```

```

-Display-
Normal
Compass
WAYPOINT
ENT QUIT
    
```

```

-Waypoint Directory-
Swim Point
FISHING PT
Port
SELECT
    
```

```

-Waypoint Input-
WPT Name: FISHING PT
ID:
Position: 33° 33. 120N
118° 06. 230W
ENT QUIT
    
```

```

BUSY 16
25W
BRG: 130° T
DST: 40NM
33° 37. 120N
118° 09. 580W
Range 50NM Loc 12:56AM
    
```

NOTE

The radio must be connected to a GPS to be able to navigate to a waypoint.

13.7 STOP NAVIGATING TO A WAYPOINT

To stop navigating to a waypoint, press the one of the Soft keys, then press the **STOP** soft key. The radio is switched to Normal Mode.

Press the **LIST** soft key to open the “Waypoint Directory” to select and navigate to a new waypoint.

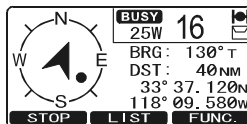

14 RAM3 (CMP30) REMOTE MIC OPERATION

When an optional **RAM3** Remote mic is connected to the **GX1600**, all VHF, DSC, setup menus, AIS, Waypoint, Compass functions and PA/Fog modes can be remotely operated. The **RAM3**'s operation is same as **GX1600** except the receiver audio volume setting and squelch level setting. The reason for the same operation is to make the operation of the radio and **RAM3** mic easy. For specific operation of the **RAM3** mic review sections in the radio manual. The **RAM3** is supplied with 23 feet (7 m) of routing cable and can be extended up to 70 feet (21 m) using three 23-foot extension cables model **CT-100**. The Intercom feature can be used between the **RAM3** and the **GX1600**. In addition, speaker wires are supplied at the panel mount of the routing cable for external speakers to be connected in noisy environments.

14.1 REMOTE MIC CONTROLS

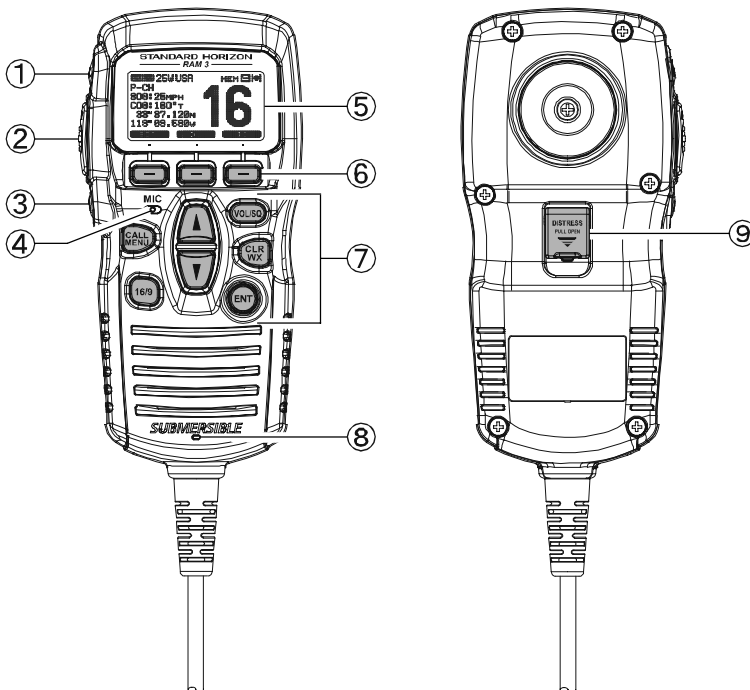

1 (H/L) KEY

Toggles between high and low power. When the (H/L) key is pressed while the transceiver is on CH13 or CH67, the power is temporarily switched from LO to HI until the **PTT** switch is released. The (H/L) key does not function on transmit inhibited and low-power only channels.

② **PTT (Push-To-Talk) Key**

Push this key to enable the transmitter.

③  **(POWER) Key**

Press and hold down this key to turn the transceiver and Remote MIC on or off.

④ **MICROPHONE**

The internal ClearVoice Noise Canceling mic is located here.

When transmitting, position your mouth about 1/2 to 1 inch (1.2 ~ 2.5 cm) away from the small mic hole. Speak slowly and clearly into the microphone.

⑤ **DISPLAY**

Full dot matrix display.

⑥ **SOFT KEY**

These three key's functions can be customized by the Setup Menu mode. When press one of these key briefly, the key functions will appear at the bottom of the display. Refer to section "15.2 ASSIGNING SOFT KEYS" for details.

⑦ **KEY PAD**



Key

Press this key to access the DSC menu.

Press and hold this key to access the SETUP menu.



Key

First press: channel 16 is immediately selected.

Second press: recalls the last selected channel.

Press and hold: selects channel 9.



(UP) /  **(DOWN) Key**

These keys are used to select channels, adjust the volume and squelch level, and to choose DSC calls, DSC setup and Radio setup function.





Key (Volume Control / Squelch Control)

First press: Volume adjustment mode

Second press: Squelch adjustment mode



Third press: exits adjustment mode

When in volume or squelch mode, press the  or  keys to adjust the level.

Key

Press to CLEAR a function or menu selection. Press and hold to select NOAA Weather channels. Press and hold again to exit Weather mode and revert to radio mode.

Secondary use

Hold down the  key while pressing the  key to change the mode from USA to International or Canadian.

Key

This key functions as the enter key.

8 SPEAKER



















The internal speaker is located here.

9 [DISTRESS] KEY

Used to send a DSC Distress call. Refer to section “9 DIGITAL SELECTIVE CALLING”.

14.2 ASSIGNING SOFT KEYS

This menu item allows selection of the number of soft keys, soft key selection and how long the display will show the soft key icon after a soft key is pressed. The keys maybe setup to control the following functions:

1. Press and hold down the  key until “Setup Menu” appears, then select “GENERAL SETUP” with the  or  key.
2. Press the  soft key, then press the  key to select “SOFT KEY”.
3. Press the  soft key, then press the  key to select “NUMBER OF SOFT KEYS”.
4. Press the  soft key, then press the  or  key to select the number of soft keys (3 through 10).
5. Press the  soft key, then press the  key to select “KEY ASSIGNMENT” (to change the use of selected soft keys). Then press the  soft key.
6. Press the  or  key to select the key (“KEY1”, “KEY2”, “KEY3” etc), and press the  soft key. Then press the  or  key to select the new function to be assigned, and press the  soft key. Available functions are listed next page. Repeat step 6 to pro-

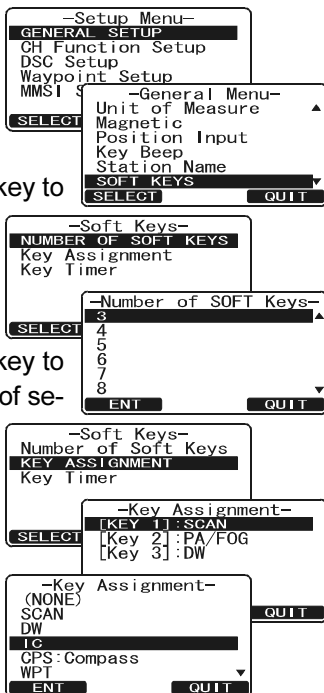

gram the other soft keys.

7. Press the **QUIT** soft key, then press the **▲** or **▼** key to select "KEY TIMER" (selects how long the soft key icon will be shown on the display after a soft key is pressed, default is 5 seconds). Then, press the **SELECT** soft key.
8. Press the **▲** or **▼** key to select the time.
9. Press the **ENT** soft key to store the selected setting.
10. Press the **QUIT** soft key several times to return to radio operation.

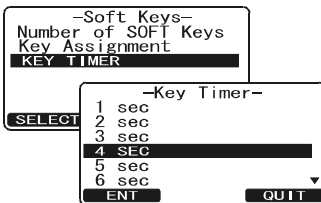

DISPLAY	FUNCTION
SCAN	Starts and stops Scanning.
DW	Starts and stops Dual Watch Scan.
IC	Activates Intercom between radio and RAM3 mic (optional RAM3 required).
CMP: COMPASS	Shows to the "Compass" display.
WPT	Shows to the "Waypoint" Navigation display.
PRESET	Saves or deletes the preset memory channel.
WX	Immediately recalls the last select the weather channel.
MARK	Marks the current position for a "Waypoint".
PRESET 0 - 9	Immediately recalls the Preset Memory Channel.

15 MAINTENANCE

The inherent quality of the solid-state components used in this transceiver will provide many years of continuous use. Taking the following precautions will prevent damage to the transceiver.

- Keep the microphone connected or the jack covered at all times to prevent corrosion of electrical contacts;
- Never key the microphone unless an antenna or suitable dummy load is connected to the transceiver.
- Ensure that the supply voltage to the transceiver does not exceed 16 VDC or fall below 11 VDC.
- Use only STANDARD HORIZON-approved accessories and replacement parts.

In the unlikely event of serious problems, please contact your Dealer or our repair facility. Address and phone numbers for this facility, as well as warranty information, are contained in section “**17 WARRANTY.**”

15.1 REPLACEMENT PARTS

Occasionally an owner needs a replacement mounting bracket or knob. These can be ordered from our Parts Department by writing or calling:

Marine Division of Vertex Standard

US Headquarters

10900 Walker Street, Cypress, CA 90630, U.S.A.

Telephone (714) 827-7600

Commonly requested parts, and their part numbers are listed below.

- **Dust Cover (HC1600):** AAH79X101
- **Power Cord:** T9025406
- **VOL and SQL Knob:** RA1282500 (White), RA1282600 (Black)
- **Mounting Bracket:** RA1283100 (White), RA1283200 (Black)
- **Mounting Bracket Knob:** RA0978500 (White), RA0978600 (Black)
- **Microphone Hanger:** RA0436000 (White), RA0458800 (Black)
- **RAM3 Mic Routing Cable Assembly:** S8101512

15.2 FACTORY SERVICE

In the unlikely event that the radio fails to perform or needs servicing, please contact the following:

Standard Horizon

Attention Marine Repair Department

10900 Walker Street, Cypress, CA 90630

Telephone (800) 366-4566

An "RA" Return Authorization number is not necessary to send a product in for service. Include a brief note describing the problem along with your name, return address, phone number, and proof of purchase.

15.3 TROUBLESHOOTING CHART

SYMPTOM	PROBABLE CAUSE	REMEDY
Transceiver fails to power up.	No DC voltage to the transceiver, or blown fuse.	a. Check the 12VDC battery connections and the fuse. b. The  key needs to be pressed and held to turn the radio on.
Transceiver blows fuse when connected to power supply.	Reversed power wires.	Check the power cable for DC voltage, or replace the fuse (6A 250V). Make sure the red wire is connected to the positive (+) battery post, and the black wire is connected to the negative (-) battery post. If the fuse still blows, contact your Dealer.
Popping or whining noise from the speaker while engine runs.	Engine noise.	Re-route the DC power cables away from the engine. Add noise suppressor on power cable. Change to resistive spark plug wires and/or add an alternator whine filter.
Sound is not emitted from the internal or external speaker.	Accessory cable.	Check the connections of the accessory cable. External speaker cable (WHITE/SHIELD) shorted together.
Receiving station reports low transmit power, even with transceiver set to HI power.	Antenna.	Have the antenna checked or test the transceiver with another antenna. If the problem persists, contact your Dealer for servicing.
"HI BATTERY" or "LO BATTERY" message appears when the power is turned on.	The power supply voltage is too high or too low.	Confirm that the connected power supply voltage is not 17 volts or lower than 10 volts.
Your position is not displayed.	Accessory cable.	Check the accessory cable connection. Some GPS Chart Plotters use the battery ground for NMEA connection.
	Setting of the GPS Chart Plotter.	Check the output signal format of the GPS Chart Plotter. This radio requires NMEA0183 format with GLL, RMB, or RMC sentence as an input signal. If the GPS has a baud rate setting make sure to select 4800 and parity to NONE.

16 CHANNEL ASSIGNMENTS

Tables on the following columns list the VHF Marine Channel assignments for U.S.A. and International use. Below are listed some data about the charts.

1. VTS. Where indicated, these channels are part of the U.S. Coast Guard's Vessel Traffic System.
2. Alpha channel numbers, that is, channel numbers followed by the letter A (such as Channel 07A) are **simplex** channels on the U.S.A. or Canadian channel assignments whose counterparts in the International assignments are **duplex** channels. International channels do not use "alpha" numbers. If you call the Coast Guard on Channel 16, they will sometimes ask you to "**go to channel 22 Alpha**." This is a channel assigned to U.S.A., and Canadian Coast Guards for handling distress and other calls. If your radio is set for **International** operation you will go to Channel 22 instead of 22A, and will not be able to communicate with the Coast Guard. To use Channel 22A, your radio must be set for **USA** or **Canada** operation, usually by a U/I/C (USA/International/Canada) control or combination of controls. Channel 22 (without an "A") is an **International** duplex channel for port operations. Some radios indicate an "A" adjacent to the alpha channels on the display; on others "alpha" is not indicated but the proper channel is selected based on the U/I/C setting.
3. Bridge-to-Bridge channels (for example, Channel 13) are for use by bridge operators on inter-coastal waterways and rivers. It is also used by marine vessels in the vicinity of these bridges for navigation and for communicating with the bridge operators. Note that a limit of 1 Watt is specified for these channels.
4. The **S/D** column on the chart indicates either S (simplex) or D (duplex). **Simplex** means transmitting and receiving on the same frequency. Only one party at a time can talk, unlike a telephone. Be sure to say "**over**" and release your microphone push-to-talk switch at the end of each transmission. **Duplex** operation involves the use of one frequency for transmitting and a separate frequency for receiving. On channels specified as duplex on the charts, correct mode of operation is established automatically by your radio when you select a channel; you cannot change the mode. And you still must release the push-to-talk switch after each transmission in order to listen to the radio.
5. Channels normally used by recreational boaters are those that include the term "non-commercial" in the **Channel Use** column of the chart. Some of these are shared with other users and some are used only in certain geographic regions.

6. Marine vessels equipped with VHF radios are required to monitor Channel 16.
7. 156.050 MHz and 156.175 MHz are available for port operations and commercial communications purposes when used only within the U.S. Coast Guard designated Vessel Traffic Services (VTS) area of New Orleans, on the lower Mississippi River from the various pass entrances in the Gulf of Mexico to Devil's Swamp Light at River Mile 242.4 above head of passes near Baton Rouge.
8. 156.250 MHz is available for port operations communications use only within the U.S. Coast Guard designated VTS radio protection areas of New Orleans and Houston described in Sec. 80.383. 156.250 MHz is available for intership port operations communications used only within the area of Los Angeles and Long Beach harbors, within a 25- nautical mile radius of Point Fermin, California.
9. 156.550 MHz, 156.600 MHz and 156.700 MHz are available in the U.S. Coast Guard designated port areas only for VTS communications and in the Great Lakes available primarily for communications relating to the movement of ships in sectors designated by the St. Lawrence Seaway Development Corporation or the U.S. Coast Guard. The use of these frequencies outside VTS and ship movement sector protected areas is permitted provided they cause no interference to VTS and ship movement communications in their respective designated sectors.
10. Use of 156.875 MHz is limited to communications with pilots regarding the movement and docking of ships. Normal output power must not exceed 1 watt. 5: 156.375 MHz and 156.650 MHz are available primarily for intership navigational communications. These frequencies are available between coast and ship on a secondary basis when used on or in the vicinity of locks or drawbridges. Normal output power must not exceed 1 watt. Maximum output power must not exceed 10 watts for coast stations or 25 watts for ship stations.
11. On the Great Lakes, in addition to bridge-to-bridge communications, 156.650 MHz is available for vessel control purposes in established vessel traffic systems. 156.650 MHz is not available for use in the Mississippi River from South Pass Lighted Whistle Buoy "2" and Southwest Pass entrance Mid-channel Lighted Whistle Buoy to mile 242.4 above Head of Passes near Baton Rouge. Additionally it is not available for use in the Mississippi River-Gulf Outlet, the Mississippi River-Gulf Outlet Canal, and the Inner Harbor Navigational Canal, except to aid the transition from these areas.

12. Use of 156.375 MHz is available for navigational communications only in the Mississippi River from South Pass Lighted Whistle Buoy "2" and Southwest Pass entrance Mid channel Lighted Whistle Buoy to mile 242.4 above head of Passes near Baton Rouge, and in addition over the full length of the Mississippi River-Gulf Outlet Canal from entrance to its junction with the Inner Harbor Navigation Canal, and over the full length of the Inner Harbor Navigation Canal from its junction with the Mississippi River to its entry to Lake Pontchartrain at the New Seabrook vehicular bridge.
13. Within 120 km (75 miles) of the United States/Canada border, in the area of the Puget Sound and the Strait of Juan de Fuca and its approaches, 157.425 MHz is half of the duplex pair designated as Channel 88. In this area, Channel 88 is available to ship stations for communications with public coast stations only. More than 120 km (75 miles) from the United States/Canada border in the area of the Puget Sound and the Strait of Juan de Fuca, its approaches, the Great Lakes, and the St. Lawrence Seaway, 157.425 MHz is available for intership and commercial communications. Outside Puget Sound area and its approaches and the Great Lakes, 157.425 MHz is also available for communications between commercial fishing vessels and associated aircraft while engaged in commercial fishing activities.
14. When the frequency 156.850 MHz is authorized, it may be used additionally for search and rescue training exercises conducted by state or local governments.
15. The frequency 156.850 MHz is additionally available to coast stations on the Great Lakes for transmission of scheduled Coded Marine Weather Forecasts (MAFOR), Great Lakes Weather Broadcast (LAWEB) and scheduled Notices to Mariners or Bulletins. F3C and J3C emissions are permitted. Coast Stations on the Great Lakes must cease weather broadcasts which cause interference to stations operating on 156.800 MHz until the interference problem is resolved.
16. The frequency 157.100 MHz is authorized for search and rescue training exercises by state or local government in conjunction with U.S. Coast Guard stations. Prior U.S. Coast Guard approval is required. Use must cease immediately on U.S. Coast Guard request.
17. The duplex pair for channel 20 (157.000/161.600 MHz) may be used for ship to coast station communications.
18. Available for assignment to coast stations, the use of which is in accord with an agreed program, for the broadcast of information to ship stations concerning the environment.

VHF MARINE CHANNEL CHART							
CH	U	C	I	S/D	TX	RX	CHANNEL USE
01		X	X	D	156.050	160.650	Public Correspondence (Marine Operator)
01A	X			S	156.050		Port Operation and Commercial. VTS in selected areas
02		X	X	D	156.100	160.700	Public Correspondence (Marine Operator)
03		X	X	D	156.150	160.750	Public Correspondence (Marine Operator)
03A	X			S	156.150		U.S. Government Only, Coast Guard
04			X	D	156.200	160.800	Public Correspondence (Marine Operator), Port operation, ship movement
04A		X		S	156.200		Pacific coast: Coast Guard, East Coast: Commercial fishing
05			X	D	156.250	160.850	Public Correspondence (Marine Operator), Port operation, ship movement
05A	X	X		S	156.250		Port operation. VTS in Seattle
06	X	X	X	S	156.300		Inter-ship Safety
07			X	D	156.350	160.950	Public Correspondence (Marine Operator), Port operation, ship movement
07A	X	X		S	156.350		Commercial
08	X	X	X	S	156.400		Commercial (Inter-ship only)
09	X	X	X	S	156.450		Boater Calling channel, Commercial & Non-commercial (Recreational)
10	X	X	X	S	156.500		Commercial
11	X	X	X	S	156.550		Commercial. VTS in selected areas.
12	X	X	X	S	156.600		Port operation. VTS in selected areas.
13	X	X	X	S	156.650		Inter-ship Navigation Safety (Bridge-to-bridge)
14	X	X	X	S	156.700		Port operation. VTS in selected areas.
15	X			S	---	156.750	Environmental (Receive only)
15		X	X	S	156.750		Commercial, non-commercial, ship movement (1 W)
16	X	X	X	S	156.800		International Distress, Safety and Calling
17	X	X	X	S	156.850		State Controlled (1 W)
18			X	D	156.900	161.500	Port operation, ship movement
18A	X	X		S	156.900		Commercial
19			X	D	156.950	161.550	Port operation, ship movement
19A	X			S	156.950		US: Commercial
19A		X		S	156.950		Coast Guard
20	X	X	X	D	157.000	161.600	Canadian Coast Guard Only, International: port operations and shipment
20A	X			S	157.000		Port operation
21			X	D	157.050	161.650	Port operation, ship movement
21A	X	X		S	157.050		U.S. Government Only, Canadian Coast Guard
22			X	D	157.100	161.700	Port operation, ship movement
22A	X	X		S	157.100		US and Canadian Coast Guard Liaison and Maritime Safety Information Broadcasts announced on channel 16
23		X	X	D	157.150	161.750	Public Correspondence (Marine Operator)
23A	X			S	157.150		U.S. Government Only
24	X	X	X	D	157.200	161.800	Public Correspondence (Marine Operator)
25	X	X	X	D	157.250	161.850	Public Correspondence (Marine Operator)
26	X	X	X	D	157.300	161.900	Public Correspondence (Marine Operator)
27	X	X	X	D	157.350	161.950	Public Correspondence (Marine Operator)
28	X	X	X	D	157.400	162.000	Public Correspondence (Marine Operator)

VHF MARINE CHANNEL CHART							
CH	U	C	I	S/D	TX	RX	CHANNEL USE
60		X	X	D	156.025	160.625	Public Correspondence (Marine Operator)
61			X	D	156.075	160.675	Public Correspondence (Marine Operator), Port operation, ship movement
61A	X	X		S	156.075		Public Coast: Coast Guard; East Coast: commercial fishing only
62			X	D	156.125	160.725	Public Correspondence (Marine Operator), Port operation, ship movement
62A		X		S	156.125		Public Coast: Coast Guard; East Coast: commercial fishing only
63			X	D	156.175	160.775	Public Correspondence (Marine Operator), Port operation, ship movement
63A	X	X		S	156.175		Port Operation and Commercial. VTS in selected areas.
64		X	X	D	156.225	160.825	Public Correspondence (Marine Operator), Port operation, ship movement
64A	X	X		S	156.225		Public Correspondence (Marine Operator), Port operation, ship movement
65			X	D	156.275	160.875	Public Correspondence (Marine Operator), Port operation, ship movement
65A	X	X		S	156.275		Port Operations
66			X	D	156.325	160.925	Public Correspondence (Marine Operator), Port operation, ship movement
66A	X	X		S	156.325		Port Operations
67	X	X	X	S	156.375		US: Commercial. Used for Bridge-to-bridge com- muni-cations in lower Mississippi River. Inter-ship only, Canada: Commercial fishing, S&R
68	X	X	X	S	156.425		Non-commercial (Recreational)
69	X	X	X	S	156.475		US: Non-commercial (Recreational), Canada: Commercial fishing only, International: Inter-ship, Port operations and Ship movement
70	X	X	X	S	156.525		Digital selective calling (voice communications not allowed)
71	X	X	X	S	156.575		US, Canada: Non-commercial (Recreational), International: Port operations and Ship movement
72	X	X	X	S	156.625		Non-commercial (Inter-ship only)
73	X	X	X	S	156.675		US: Port Operations, Canada: Commercial fishing only, International: Inter-ship, Port operations and Ship movement
74	X	X	X	S	156.725		US: Port Operations, Canada: Commercial fishing only, International: Inter-ship, Port operations and Ship movement
75	X	X	X	S	156.775		Port Operations (Inter-ship only) (1W)
76	X	X	X	S	156.825		Port Operations (Inter-ship only) (1W)
77	X	X		S	156.875		Port Operations (Inter-ship only) (1W)
77			X	S	156.875		Port Operations (Inter-ship only)
78			X	D	156.925	161.525	Public Correspondence (Marine Operator), Port operation, ship-movement
78A	X	X		S	156.925		Non-commercial (Recreational)
79			X	D	156.975	161.575	Port operation and Ship movement
79A	X	X		S	156.975		Commercial

VHF MARINE CHANNEL CHART							
CH	U	C	I	S/D	TX	RX	CHANNEL USE
80			X	D	157.025	161.625	Port operation, ship movement
80A	X	X		S	157.025		Commercial
81			X	D	157.075	161.675	Port operation, ship movement
81A	X			S	157.075		U.S. Government Only - Environmental protection operations.
81A		X		S	157.075		Canadian Coast Guard Only
82			X	D	157.125	161.725	Public Correspondence (Marine Operator), Port operation, ship movement
82A	X	X		S	157.125		U.S. Government Only, Canadian Coast Guard Only
83		X		D	157.175	161.775	Canadian Coast Guard Only
83			X	D	157.175	161.775	Public Correspondence (Marine Operator)
83A	X	X		S	157.175		U.S. Government Only, Canadian Coast Guard Only
84	X	X	X	D	157.225	161.825	Public Correspondence (Marine Operator)
85	X	X	X	D	157.275	161.875	Public Correspondence (Marine Operator)
86	X	X	X	D	157.325	161.925	Public Correspondence (Marine Operator)
87		X	X	S	157.375		Port operation, ship movement
87A	X			S	157.375		Public Correspondence (Marine Operator)
88		X	X	S	157.425		Port operation, ship movement
88A	X			S	157.425		Commercial, Inter-ship Only
WX01	X	X	X	D	---	162.550	Weather (receive only)
WX02	X	X	X	D	---	162.400	Weather (receive only)
WX03	X	X	X	D	---	162.475	Weather (receive only)
WX04	X	X	X	D	---	162.425	Weather (receive only)
WX05	X	X	X	D	---	162.450	Weather (receive only)
WX06	X	X	X	D	---	162.500	Weather (receive only)
WX07	X	X	X	D	---	162.525	Weather (receive only)
WX08	X	X	X	D	---	161.650	Weather (receive only)
WX09	X	X	X	D	---	161.775	Weather (receive only)
WX10	X	X	X	D	---	163.275	Weather (receive only)

NOTE: Simplex channels, 3A, 21A, 23A, 61A, 64A, 81A, 82A and 83A CANNOT be lawfully used by the general public in U.S.A. waters.

17 WARRANTY

Marine Products Limited Warranty

PLEASE NOTE

The following “Limited Warranty” is for valid for products that have been purchased in the United States and Canada. For limited Warranty details outside the United States, contact the dealer in your country.

STANDARD HORIZON (a division of VERTEX STANDARD) warrants, to the original purchaser only, each new Marine Communications Product (“Product”) manufactured and/or supplied by STANDARD HORIZON against defects in materials and workmanship under normal use and service for a period of time from the date of purchase as follows:

Fixed Mount and Portable Transceivers

1 year - if purchased before 01/01/91

3 years - if purchased between 01/01/91 and 01/01/94

3 years Waterproof - if purchased after 01/01/94

Loud hailers

1 year - if purchased before 01/01/91

3 years - if purchased after 01/01/91

Associated Chargers

1 year - if purchased before 01/01/91

3 years - if purchased after 01/01/91

Associated Batteries - 18 months. Note: Batteries will be deemed defective only if storage capacity drops below 80% of rated capacity or if leakage develops.

Associated Accessories - 1 year. Includes: Microphones/Handsets, External Speakers, Antennas, Carrying Accessories, Power Supplies, and Signaling Boards.

To receive warranty service, the purchaser must deliver the Product, transportation and insurance prepaid, to STANDARD HORIZON (a division of VERTEX STANDARD), Attention Marine repairs 10900 Walker Street, Cypress, CA 90630. Include proof of purchase indicating model, serial number, and date of purchase. STANDARD HORIZON will return the Product to the purchaser freight prepaid. Products purchased prior to January 1, 1991 will bear the STANDARD HORIZON warranty terms in effect prior to that date.

In the event of a defect, malfunction or failure of the Product during the warranty period, STANDARD HORIZON's liability for any breach of contract or any breach of express or implied warranties in connection with the sale of Products shall be limited solely to repair or replacement, at its option, of the Product or part(s) therein which, upon examination by STANDARD HORIZON,

appear to be defective or not up to factory specifications. STANDARD HORIZON may, at its option, repair or replace parts or subassemblies with new or reconditioned parts and subassemblies. Parts thus repaired or replaced are warranted for the balance of the original applicable warranty.

STANDARD HORIZON will not warrant installation, maintenance or service of the Products. In all instances, STANDARD HORIZON's liability for damages shall not exceed the purchase price of the defective Product.

This warranty only extends to Products sold within the 50 States of the United States of America and the District of Columbia.

STANDARD HORIZON will pay all labor to repair the product and replacement parts charges incurred in providing the warranty service except where purchaser abuse or other qualifying exceptions exist. The purchaser must pay any transportation expenses incurred in returning the Product to STANDARD HORIZON for service.

This limited warranty does not extend to any Product which has been subjected to misuse, neglect, accident, incorrect wiring by anyone other than STANDARD HORIZON, improper installation, or subjected to use in violation of instructions furnished by STANDARD HORIZON, nor does this warranty extend to Products on which the serial number has been removed, defaced, or changed. STANDARD HORIZON cannot be responsible in any way for ancillary equipment not furnished by STANDARD HORIZON which is attached to or used in connection with STANDARD HORIZON's Products, or for the operation of the Product with any ancillary equipment, and all such equipment is expressly excluded from this warranty. STANDARD HORIZON disclaims liability for range, coverage, or operation of the Product and ancillary equipment as a whole under this warranty. STANDARD HORIZON reserves the right to make changes or improvements in Products, during subsequent production, without incurring the obligation to install such changes or improvements on previously manufactured Products.

The implied warranties which the law imposes on the sale of this Product are expressly LIMITED, in duration, to the time period specified above. STANDARD HORIZON shall not be liable under any circumstances for consequential damages resulting from the use and operation of this Product, or from the breach of this LIMITED WARRANTY, any implied warranties, or any contract with STANDARD HORIZON. IN CONNECTION WITH THE SALE OF ITS PRODUCTS, STANDARD HORIZON MAKES NO WARRANTIES, EXPRESS OR IMPLIED AS TO THE MERCHANTABILITY OR FITNESS FOR A PARTICULAR PURPOSE OR OTHERWISE, EXCEPT AS EXPRESSLY SET FORTH HEREIN.

Some states do not allow the exclusion or limitation of incidental or consequential damages, or limitation on how long an implied warranty lasts, so the above limitations or exclusions may not apply. This warranty gives specific legal rights, and there may be other rights which may vary from state to state.

ONLY PRODUCTS SOLD ON OR AFTER JANUARY 1, 1991 ARE COVERED UNDER THE TERMS OF THIS LIMITED WARRANTY.

ON-LINE WARRANTY REGISTRATION

THANK YOU for buying STANDARD HORIZON (a division of Vertex Standard) products! We are confident your new radio will serve your needs for many years!

Please visit **www.standardhorizon.com** to register your Marine VHF. It should be noted that visiting the Web site from time to time may be beneficial to you, as new products are released they will appear on the STANDARD HORIZON Web site. Also a statement regarding product support should be added to the manual.

Product Support Inquiries

If you have any questions or comments regarding the use of the radio, you can visit the STANDARD HORIZON Web site to send an E-Mail or contact the Product Support team at (714) 827-7600 ext 6300 M-F 7:00-5:00PST.

In addition to the warranty, STANDARD HORIZON includes a lifetime "flat rate" and "customer loyalty" programs to provide service after the warranty period has expired. If you wish to obtain the flat rate price for out-of-warranty repair, you must include the information on the Owner's Record with the unit when you return it to your Dealer or to STANDARD HORIZON.

Lifetime Flat Rate Service Program: For the original Owner only, for the lifetime of the unit, STANDARD HORIZON will repair the unit to original specifications.

Note: The flat rate amount is payable by the Owner only if STANDARD HORIZON or the STANDARD HORIZON Dealer determines that a repair is needed. After the repair, a 90-day warranty will be in effect from the date of return of the unit to the Owner.

This service program is not available for equipment which has failed as a result of neglect, accident, breakage, misuse, improper installation or modification, or water damage (depending on the product).

18 RESET PROCEDURES



18.1 MEMORY CLEAR

To clear the Scan memory and Preset memory:

1. Turn the radio off.
2. Press and hold in the three [Programmable] keys while turning the radio on.

18.2 MICROPROCESSOR RESETTING

To clear all memories and other settings to factory defaults (except the Channel Group, MMSI number, and DSC directory information):

1. Turn the radio off.
2. Press and hold in the ,  and  keys while turning the radio on. While resetting the radio, the display will show the display to the right for about 10 seconds, then turn on.



EE-PROM
Resetting

19 SPECIFICATIONS

Performance specifications are nominal, unless otherwise indicated, and are subject to change without notice.

19.1 GENERAL

Channels	All USA, International and Canadian
Normal Input Voltage	13.8 V DC
Operating Voltage Range	11 V to 16.5 V
Current Drain	
Standby	0.45 A
Receiver (at Maximum AF Output)	0.8 A
Transmit	5.0 A (Hi), 1.0 A (Lo)
Operating Temperature Range	-4 °F to +140 °F (-20 °C to +60 °C)
Distress Call Log	27
Individual Call Log	64
Individual Call Directory	80
Group Call Directory	32
Waypoint Directory	100
Display Type	2.75" x 1.33" (70 x 34 mm) Full Dot Matrix (132 x 64 pixels)
Dimensions (WxHxD)	5.90" x 3.35" x 3.54" (150 x 85 x 90 mm)
Flush-Mount Dimensions (WxHxD)	5.39" x 2.84" x 3.54" (137 x 72 x 90 mm)
Weight	1.98 lbs (0.9 kg)

19.2 TRANSMITTER

Frequency Range	156.025 MHz to 157.425 MHz
RF Output Power	25 W (Hi), 1 W (Lo)
Conducted Spurious Emissions	Less than -80 dBc (Hi), -66 dBc (Lo)
Audio Response	within +1/-3dB of a 6 dB/Octave pre-emphasis characteristic at 300 to 3000 Hz
Audio Distortion	Less than 5 %
Modulation	16K0G3E (for Voice), 16K0G2B (for DSC)
Frequency Stability	±0.0003 % (-4 °F to +140 °F [-20 °C to +60 °C])
FM Hum and Noise	50 dB

19.3 RECEIVER

Frequency Range	156.050 MHz to 163.275 MHz
Sensitivity	
20 dB Quieting	0.35 μ V
12 dB SINAD	0.25 μ V
Squelch Sensitivity (Threshold)	0.13 μ V
Modulation Acceptance Bandwidth	\pm 7.5 kHz
Selectivity (Typical)	
Spurious and Image Rejection	80 dB for Voice (75 dB for DSC)
Intermodulation and Rejection	70 dB for Voice (70 dB for DSC)
Audio Output	4.5 W (at 4 ohms external speaker output)
Audio Response	within +1/-3dB of a 6 dB/Octave de-emphasis characteristic at 300 to 3000 Hz
Frequency Stability	\pm 0.0003 % (-4 °F to +140 °F [-20 °C to +60 °C])
Channel Spacing	25 kHz
DSC Format	ITU-R M.493-12

19.4 NMEA INPUT/OUTPUT

NMEA 0183 GPS Input (4800 baud)	GGA, GLL, GNS, RMC
NMEA 0183 DSC Output (4800 baud)	DSC and DSE

19.5 DIMENSIONS

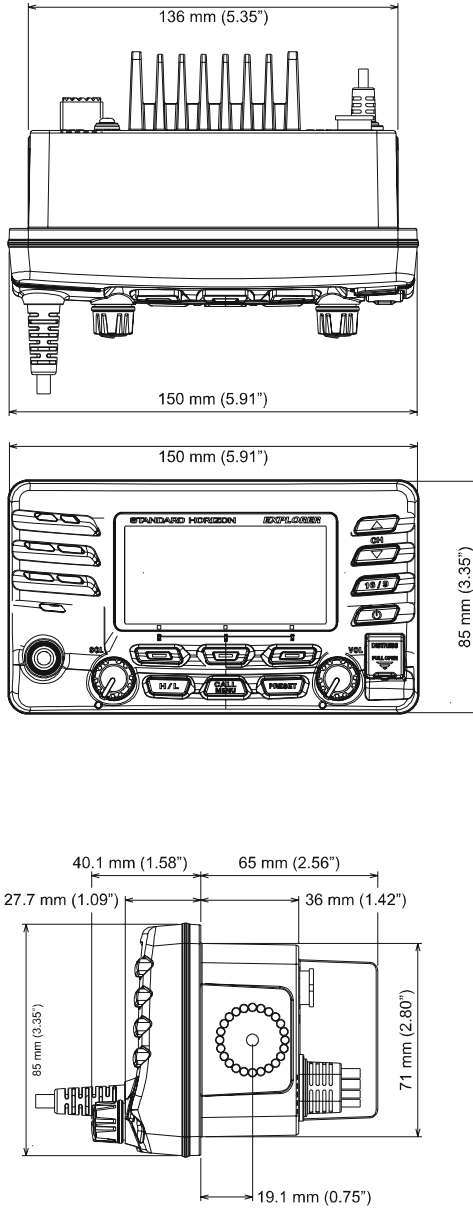

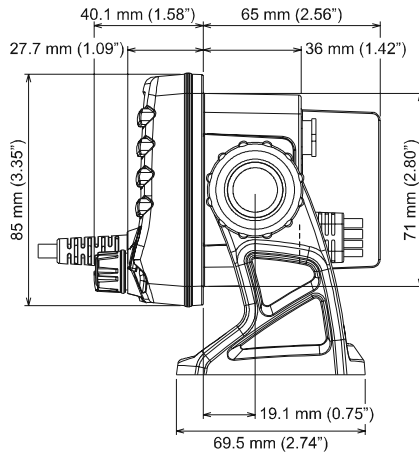
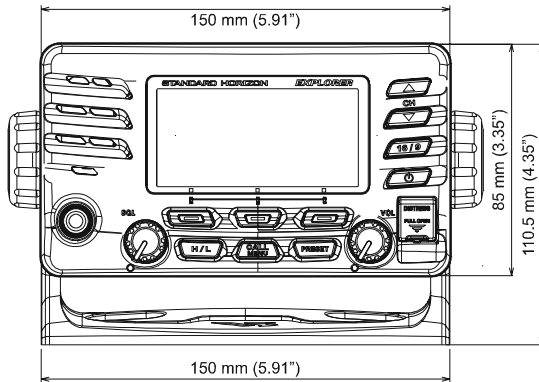
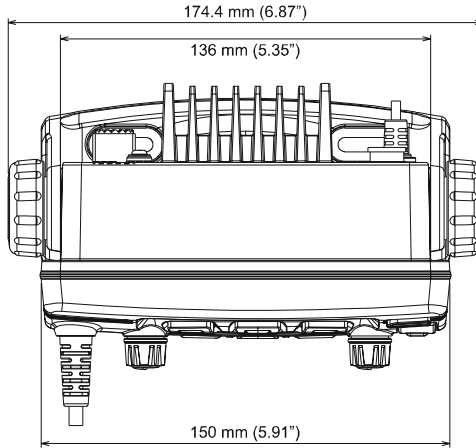

20 FCC RADIO LICENSE INFORMATION

Standard Horizon radios comply with the Federal Communication Commission (FCC) requirements that regulate the Maritime Radio Service.

20.1 STATION LICENSE

An FCC ship station license is no longer required for any vessel traveling in U.S. waters (except Hawaii) which is under 20 meters in length. However, any vessel required to carry a marine radio on an international voyage, carrying a HF single side band radiotelephone or marine satellite terminal is required to have a ship station license. FCC license forms, including applications for ship (605) and land station licenses can be downloaded via the Internet at <http://www.fcc.gov/Forms/Form605/605.html>. To obtain a form from the FCC, call (888) 225-5322.

20.2 RADIO CALL SIGN

Currently the FCC does not require recreational boaters to have a Ship Radio Station License. The USCG recommends the boats registration number and the state to be used when calling another vessel.

20.3 CANADIAN SHIP STATION LICENSING

You may need a license when traveling in Canada. If you do need a license contact their nearest field office or regional office or write:

**Industry Canada
Radio Regulatory Branch
Attn: DOSP
300 Slater Street
Ottawa, Ontario
Canada, KIA 0C8**

20.4 FCC / INDUSTRY CANADA INFORMATION

The following data pertaining to the transceiver is necessary to fill out the license application.

Type Acceptance FCC Part 80
Output Power 1 Watt (low) and 25 Watts (high)
Emission 16K0G3E, 16K0G2B
Frequency Range 156.025 to 163.275 MHz
FCC Type Number K6630483X3D
Industry Canada Type Approval 511B-30483X3S

21 FCC NOTICE

NOTICE

Unauthorized changes or modifications to this equipment may void compliance with FCC Rules. Any change or modification must be approved in writing by STANDARD HORIZON.

NOTICE

This equipment has been tested and found to comply with the limits for a Class B digital device, pursuant to Part 15 of the FCC Rules. These limits are designed to provide reasonable protection against harmful interference in a residential installation. This equipment generates, uses and can radiate radio frequency energy and, if not installed and used in accordance with the instructions, may cause harmful interference to radio communications. However, there is no guarantee that interference will not occur in a particular installation. If this equipment does cause harmful interference to radio or television reception, which can be determined by turning the equipment off and on, the user is encouraged to try to correct the interference by one or more of the following measures:

- Reorient or relocate the receiving antenna.
- Increase the separation between the equipment and receiver.
- Connect the equipment into an outlet on a circuit different from that to which the receiver is connected.
- Consult the dealer or an experienced radio/TV technician for help.

This device complies with part 15 of the FCC rules. Operation is subject to the condition that this device does not cause harmful interference.

Part 15.21: Changes or modifications to this device not expressly approved by Vertex Standard could void the User's authorization to operate this device.



**Marine Division of VERTEX STANDARD
US Headquarters**

10900 Walker Street, Cypress, CA 90630, U.S.A.

www.standardhorizon.com



E M O 4 8 N 1 0 1

Copyright 2011
VERTEX STANDARD CO., LTD.
All rights reserved.

No portion of this manual
may be reproduced
without the permission of
VERTEX STANDARD CO., LTD.

Printed in China