

**FURUNO**

# **NAV***pilot*

AUTO PILOT

**NAVpilot-700**

**NAVpilot-711**

**NAVpilot-720**



**NAVpilot-700**



**NAVpilot-711**



**NAVpilot-720**



**FURUNO ELECTRIC CO., LTD.**

[www.furuno.com](http://www.furuno.com)

**OPERATOR'S MANUAL**

**ECF**

(Elemental Chlorine Free)

The paper used in this manual  
is elemental chlorine free.

**FURUNO ELECTRIC CO., LTD.**

9-52 Ashihara-cho,  
Nishinomiya, 662-8580, JAPAN

• FURUNO Authorized Distributor/Dealer

All rights reserved. Printed in Japan

Pub. No. OME-72720-F1

(REFU) NAVpilot-700/711/720

A : DEC. 2009

F1 : JUN. 12, 2012

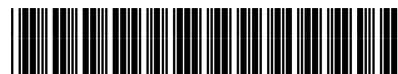

\* 0 0 0 1 7 1 8 1 2 1 5 \*

# IMPORTANT NOTICES

---

## General

- This manual has been authored with simplified grammar, to meet the needs of international users.
- The operator of this equipment must read and follow the descriptions in this manual. Wrong operation or maintenance can cancel the warranty or cause injury.
- Do not copy any part of this manual without written permission from FURUNO.
- If this manual is lost or worn, contact your dealer about replacement.
- The contents of this manual and equipment specifications can change without notice.
- The example screens (or illustrations) shown in this manual can be different from the screens you see on your display. The screens you see depend on your system configuration and equipment settings.
- Save this manual for future reference.
- Any modification of the equipment (including software) by persons not authorized by FURUNO will cancel the warranty.
- All brand and product names are trademarks, registered trademarks or service marks of their respective holders.

## How to discard this product

Discard this product according to local regulations for the disposal of industrial waste. For disposal in the USA, see the homepage of the Electronics Industries Alliance (<http://www.eiae.org/>) for the correct method of disposal.

## How to discard a used battery

Some FURUNO products have a battery(ies). To see if your product has a battery, see the chapter on Maintenance. Follow the instructions below if a battery is used. Tape the + and - terminals of battery before disposal to prevent fire, heat generation caused by short circuit.

### In the European Union

The crossed-out trash can symbol indicates that all types of batteries must not be discarded in standard trash, or at a trash site. Take the used batteries to a battery collection site according to your national legislation and the Batteries Directive 2006/66/EU.

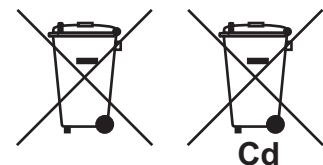

### In the USA

The Mobius loop symbol (three chasing arrows) indicates that Ni-Cd and lead-acid rechargeable batteries must be recycled. Take the used batteries to a battery collection site according to local laws.

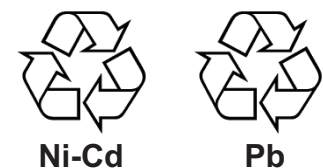



### In the other countries

There are no international standards for the battery recycle symbol. The number of symbols can increase when the other countries make their own recycle symbols in the future.













# SAFETY INSTRUCTIONS



Please read these safety instructions before you operate the equipment.

 <b>WARNING</b>	Indicates a condition that can cause death or serious injury if not avoided.
 <b>CAUTION</b>	Indicates a condition that can cause minor or moderate injury if not avoided.

 Warning, Caution	 Prohibitive Action	 Mandatory Action
--	--	--

 <b>WARNING</b>	
	<b>Do not open the equipment unless you are well familiar with electrical circuits.</b> Only qualified personnel should work inside the equipment.
	<b>Do not set the course changing speed too high.</b> The boat will be turned too sharply at the course change, which could create a very dangerous situation.
	<b>Do not use the autopilot in the following situations:</b> - Harbor entrance or narrow channel - Where vessels change course often, such as a cape or small island
	<b>Observe the following cautions when using the autopilot:</b> - Maintain a vigilant watch - Watch for drifting of vessel
	<b>In an emergency, manually steer the vessel.</b> The autopilot cannot avoid vessels, etc. automatically.
	<b>Do not use the SIMULATION mode on the boat.</b> The rudder may move suddenly. This is a special-purpose mode for technicians.

 <b>WARNING</b>	
	<b>Do not use the ORBIT mode in rough seas.</b> Because the boat turns a 360° circle around the waypoint, a large wave or strong wind can cause the boat to capsize.
	<b>For the figure-eight mode, confirm that no object is in the general vicinity of the waypoint.</b> The distance from the waypoint to the turning point depends on boat's speed.
	<b>Use the correct fuse.</b> Use of a wrong fuse can cause fire or damage the equipment.

 <b>CAUTION</b>	
	<b>In case of power failure, turn off the autopilot or manually steer the vessel.</b> Leaving the equipment in the AUTO or NAV mode during power failure will cause wear on the rudder mechanism.

### WARNING LABEL

A warning label is attached to the processor unit. Do not remove the label. If the label is missing or damaged, contact your dealer about replacement.

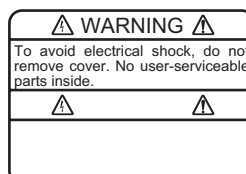

Name: Warning Label (1)  
Type: 86-003-1011  
Code No.: 100-236-231

# TABLE OF CONTENTS

---

<b>FOREWORD</b> .....	<b>vi</b>
<b>SYSTEM CONFIGURATION</b> .....	<b>vii</b>
<b>1. INTRODUCTION</b> .....	<b>1-1</b>
1.1 Controls.....	1-1
1.1.1 Control Unit FAP-7001 .....	1-1
1.1.2 Control Unit FAP-7011 .....	1-2
1.1.3 Control Unit FAP-7021 .....	1-2
1.2 How to Turn Power On, Off.....	1-3
1.3 How to Adjust Brilliance, Contrast .....	1-4
1.3.1 NAVpilot-700 .....	1-4
1.3.2 NAVpilot-711, NAVpilot-720 .....	1-4
1.4 Displays in the STBY, AUTO, NAV, WIND and FishHunter™ Modes .....	1-5
1.4.1 Content of displays in the STBY, AUTO, NAV, WIND and FishHunter™ modes.....	1-5
1.4.2 Graphic displays.....	1-9
1.4.3 How to select the data to show in the STBY mode .....	1-12
1.4.4 How to select displays from the menu.....	1-13
<b>2. STEERING MODES</b> .....	<b>2-1</b>
2.1 STBY Mode .....	2-1
2.2 AUTO Modes.....	2-2
2.2.1 AUTO mode .....	2-2
2.2.2 ADVANCED AUTO mode .....	2-4
2.3 NAV Mode .....	2-5
2.3.1 How to get the NAV mode.....	2-5
2.3.2 Sailing method for the NAV mode .....	2-8
2.3.3 Waypoint switching method.....	2-9
2.3.4 How to set the steering behavior of your boat after you arrive to a waypoint.....	2-9
2.4 Response Feature .....	2-10
2.4.1 How to activate and set the response feature .....	2-10
2.4.2 How to deactivate the response feature.....	2-10
2.5 TURN Mode.....	2-11
2.5.1 How to select a turn and start the turn .....	2-11
2.5.2 180° turn.....	2-12
2.5.3 360° turn.....	2-12
2.5.4 User turn.....	2-12
2.6 FishHunter™ Mode .....	2-13
2.6.1 How to preset FishHunter™ turn parameters .....	2-13
2.6.2 How to select a FishHunter™ turn and start the turn .....	2-14
2.6.3 Circle turn .....	2-15
2.6.4 Orbit turn .....	2-16
2.6.5 Spiral turn .....	2-16
2.6.6 Figure-eight turn .....	2-17
2.6.7 Square turn.....	2-17
2.6.8 Zigzag turn .....	2-18
2.7 How to Navigate to a TLL Position .....	2-18
2.8 REMOTE Mode .....	2-19
2.8.1 Dial-type remote controller (FAP-5551, FAP-5552) .....	2-19
2.8.2 Button-type remote controller (FAP-6211, FAP-6212), Dodge-type remote controller (FAP-6231, FAP-6232), Lever-type remote controller (FAP-6221, FAP-6222).....	2-20

## TABLE OF CONTENTS

2.9	DODGE Mode .....	2-22
2.9.1	How to dodge in the AUTO and NAV modes .....	2-22
2.9.2	How to FU dodge in the STBY mode .....	2-23
2.9.3	How to NFU dodge in the STBY mode .....	2-23
2.10	WIND Mode (for sailboats) .....	2-23
2.10.1	How to get the WIND mode .....	2-23
2.10.2	Wind angle mode .....	2-24
2.10.3	TACK mode .....	2-25
2.10.4	Tacking in WIND mode (WIND TACK) .....	2-27
2.11	Safe Helm Mode .....	2-31
2.12	Power Assist Mode .....	2-33
<b>3.</b>	<b>ALARMS .....</b>	<b>3-1</b>
3.1	ALARM Menu .....	3-1
3.2	Alarm Buzzer .....	3-2
3.3	Buzzer Interval .....	3-2
3.4	Watch Alarm .....	3-3
3.5	Deviation Alarm .....	3-3
3.6	XTE Alarm .....	3-4
3.7	Arrival Alarm .....	3-5
3.8	Speed Alarm .....	3-5
3.9	Depth Alarm .....	3-6
3.10	Water Temperature Alarm .....	3-6
3.11	Trip Distance Alarm, Trip Distance Reset .....	3-7
3.11.1	How to set the log trip alarm .....	3-7
3.11.2	How to reset the trip distance .....	3-7
3.12	Wind Alarms (for sailboats) .....	3-8
3.12.1	Heading change alarm .....	3-8
3.12.2	Wind deviation alarm .....	3-9
3.12.3	True wind speed alarm .....	3-9
3.12.4	Apparent wind speed alarm .....	3-9
3.13	Alarm Log .....	3-10
<b>4.</b>	<b>HOW TO CUSTOMIZE YOUR NAVPILOT .....</b>	<b>4-1</b>
4.1	Parameter Setup (PARAMETER SETUP Menu) .....	4-1
4.1.1	Sea state .....	4-2
4.1.2	Trim gain .....	4-5
4.1.3	Speed calculation .....	4-6
4.2	Rudder Drive Level (For Fantum Feedback™) .....	4-6
4.3	Net Towing .....	4-7
4.4	Course After Operation of a Remote Controller .....	4-7
4.5	Nav Data Source .....	4-8
4.6	NavNet vx2 Synchronization .....	4-8
4.7	SYSTEM SETUP Menu .....	4-9
4.8	Menu Shortcuts .....	4-11
4.8.1	How to create a menu shortcut .....	4-11
4.8.2	How to delete a menu shortcut .....	4-11
<b>5.</b>	<b>MAINTENANCE, TROUBLESHOOTING .....</b>	<b>5-1</b>
5.1	Preventive Maintenance .....	5-1
5.2	Replacement of Fuse .....	5-2
5.3	Diagnostics .....	5-2
5.3.1	Diagnostic menu .....	5-2
5.3.2	Processor unit test .....	5-3
5.3.3	Control unit test .....	5-3
5.3.4	NMEA0183 test .....	5-4

- 5.3.5 CAN bus test .....5-4
- 5.3.6 Keyboard test .....5-5
- 5.3.7 Screen test .....5-5
- 5.3.8 Rudder test .....5-6
- 5.3.9 Helm sensor test .....5-8
- 5.4 System Data .....5-8
- 5.5 Messages .....5-9
  - 5.5.1 Message pop-up display .....5-9
  - 5.5.2 Message board .....5-9
  - 5.5.3 Message description .....5-9
- 5.6 Sensor in Use Display .....5-12

- APPENDIX 1 MENU TREE .....AP-1**
- SPECIFICATIONS .....SP-1**
- INDEX .....IN-1**

# FOREWORD

---

## A Word to the Owner of the NAVpilot-700/711/720

Congratulations on your choice of the NAVpilot-700/711/720. We are confident you will see why the FURUNO name has become synonymous with quality and reliability.

Since 1948, FURUNO Electric Company has enjoyed an enviable reputation for innovative and dependable marine electronics equipment. This dedication to excellence is furthered by our extensive global network of agents and dealers.

Your equipment is designed and constructed to meet the rigorous demands of the marine environment. However, no machine can perform its intended function unless properly operated and maintained. Please carefully read and follow the operation and maintenance procedures set forth in this manual.

Thank you for considering and purchasing FURUNO.

We would appreciate feedback from you, the end-user, about whether we are achieving our purposes.

## Features

- “Adaptive” technology allows NAVpilot to continue improving your vessel’s steering on every voyage
- Versatile, high-resolution monochrome LCDs provide a variety of user-defined display configurations
- Auto set-up and self-learning for vessel speed and course
- One-touch operation for STBY, NAV and AUTO modes
- “FishHunter™” guides your vessel in circle, orbit, spiral, figure-eight, square or zigzag maneuver around fish or other target
- The NAVpilot-720 (handheld type) can work as a full-functioned remote control unit within a NAVpilot system
- Network up to six full-size NAVpilot-700, compact NAVpilot-711 and/or handheld NAVpilot-720 control units



# SYSTEM CONFIGURATION

NAVpilot-700/711/720 can be controlled with the rudder reference unit or without it (Fantum Feedback™). For details of Fantum Feedback™, see the installation manual (IME-72720-x).

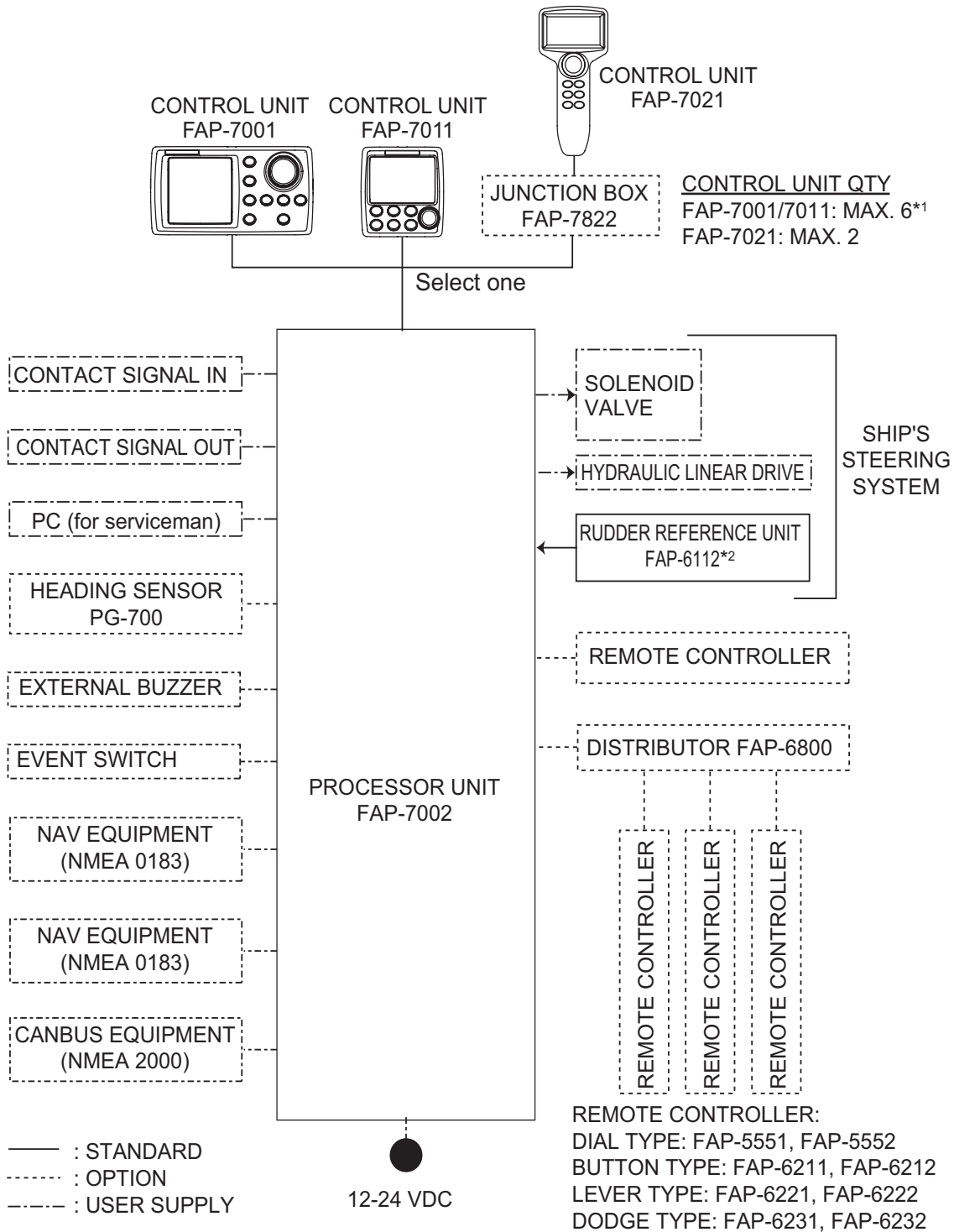

\*1: Any combination of FAP-7001 and FAP-7011 is available. Also, FAP-7021 can be connected at the end of series.

\*2: RRU is not required for Fantum Feedback™.

This page is intentionally left blank.

# 1. INTRODUCTION

---

## 1.1 Controls

The Control Unit for your NAVpilot is either the FAP-7001, FAP-7011, or FAP-7021.

The descriptions in this manual mainly follow the key names of the NAVpilot-700 (Control Unit FAP-7001). Refer to the table below for equivalent controls on the NAVpilot-711 and NAVpilot-720.

### 1.1.1 Control Unit FAP-7001

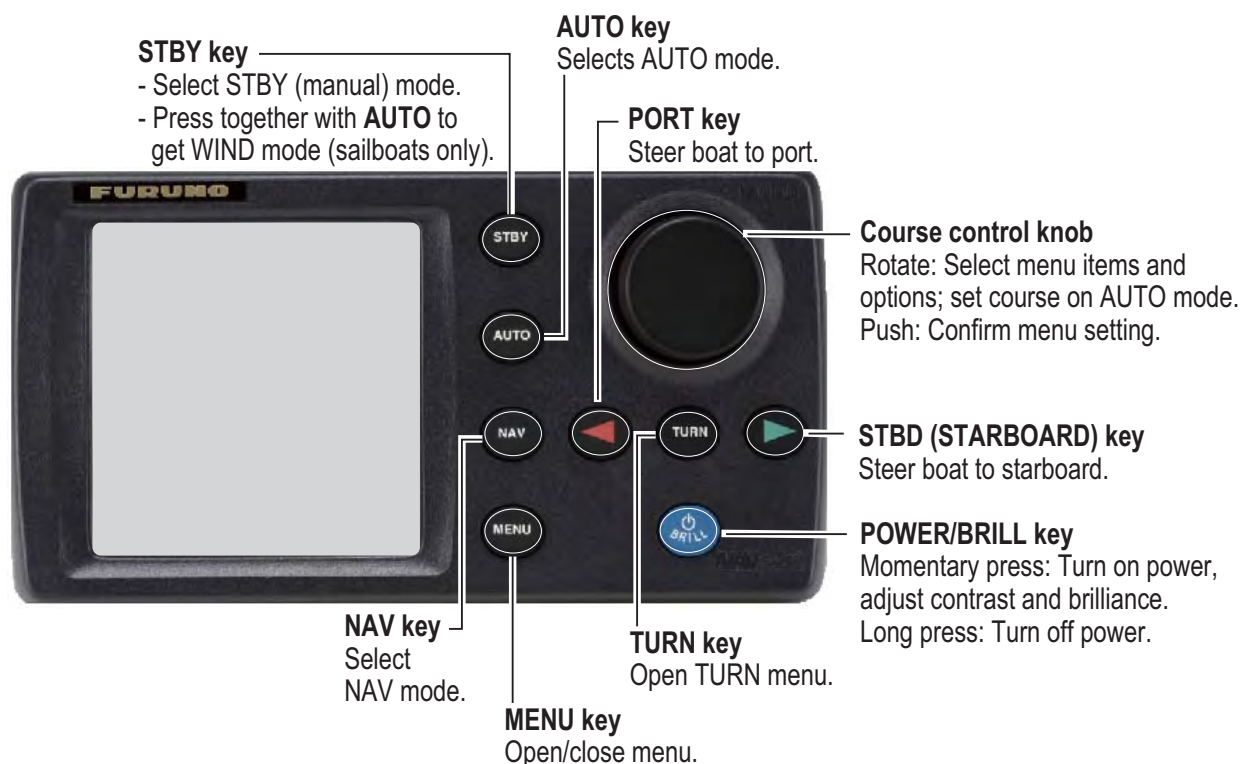

1. INTRODUCTION

1.1.2 Control Unit FAP-7011

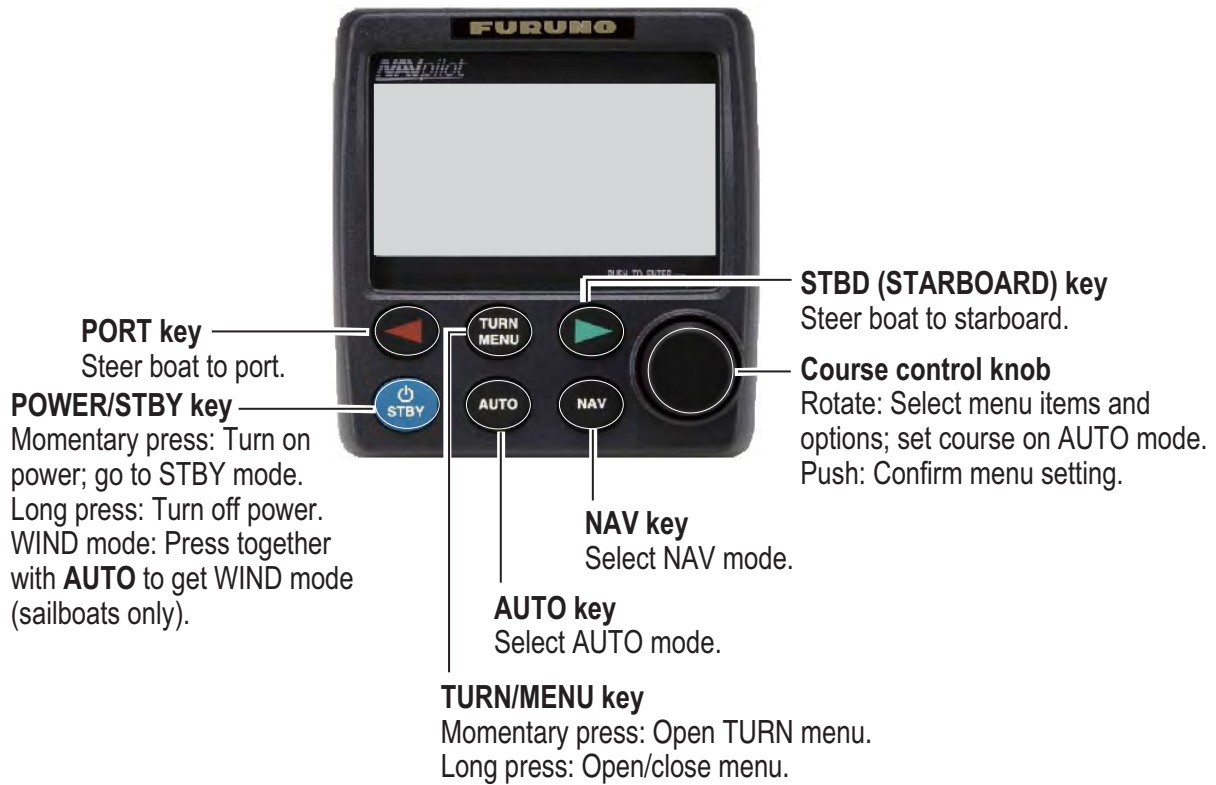

1.1.3 Control Unit FAP-7021

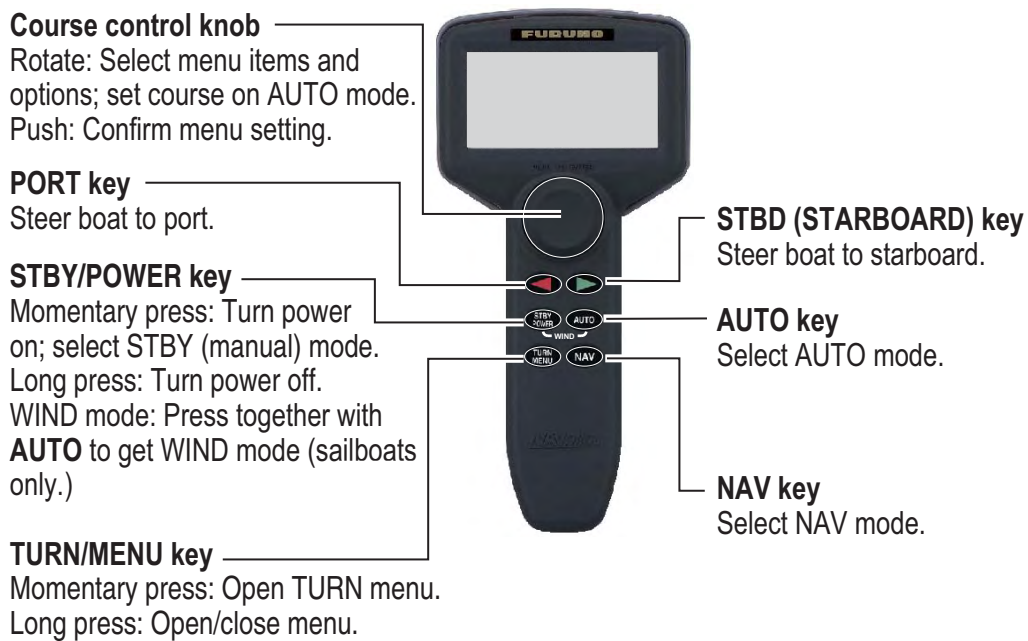

## 1.2 How to Turn Power On, Off

Control unit	Key	ON	OFF
FAP-7001	POWER/BRILL	Short-press	Long-press*
FAP-7011	POWER/STBY	Short-press	Long-press*
FAP-7021	STBY/POWER	Short-press	Long-press*

\*:A timer counts down the time that remains until the power goes off

When the heading sensor PG-500 (or PG-700) is connected, see the note at the bottom of this page. A beep sounds and the equipment shows product information followed by the results of the startup test. The start up test checks the ROM, RAM and backup of the processor unit and control unit. The test also checks for the presence of heading from the heading sensor and rudder angle information from the rudder reference unit.

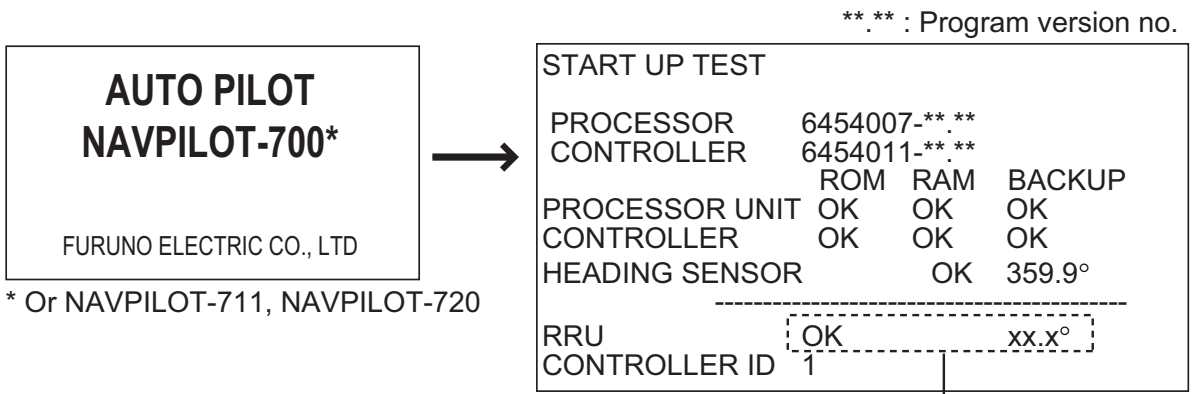

\* Or NAVPILOT-711, NAVPILOT-720

For Fantum Feedback™, "FANTUM FEEDBACK" is displayed.

If NG appears for any item, an error message, shown in the table below, appears. Follow the information provided in the message to restore normal operation. If you cannot restore normal operation, contact your dealer for information.

Error message	Meaning
BACK UP DATA IS BROKEN. USE FACTORY DEFAULT. PUSH ANY KEY TO CONTINUE.	Backup data is corrupted.
CAN NOT RECEIVE HEADING DATA. PLEASE CHECK THE HEADING SENSOR. PUSH ANY KEY TO CONTINUE.	Problem with heading sensor.
SYSTEM HAS FAILED STARTUP TEST. PLEASE CONTACT LOCAL FURUNO REPRESENTATIVE FOR REPAIR. PUSH ENTER KNOB TO CONTINUE.	The system has failed the startup test.

**Note:** When the Heading Sensor PG-500/PG-700 is connected, turn on the NAVpilot and wait four minutes before you leave port. This allows time for the PG-500/PG-700 heading data to stabilize.

## 1.3 How to Adjust Brilliance, Contrast

### 1.3.1 NAVpilot-700

1. Short-push the **POWER/BRILL** key to show the screen for the adjustment of contrast and brilliance.



2. Operate the **Course control** knob to adjust the contrast. (Contrast can also be adjusted (cyclically) with the **POWER/BRILL** key.)
3. Operate the ◀ or ▶ key to adjust the brilliance.
4. Push the **Course control** knob to close the screen, or wait several seconds for the screen to close automatically.

### 1.3.2 NAVpilot-711, NAVpilot-720

1. Long-push the **TURN/MENU** key to open the menu.

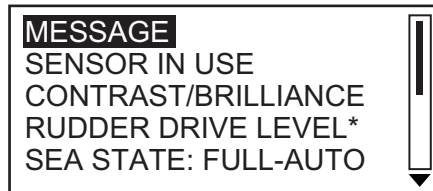

\*: Shown with Fantum Feedback™.

2. Rotate the **Course control** knob to select [CONTRAST/BRILLIANCE] then push the knob. The screen for the adjustment of contrast and brilliance appears.

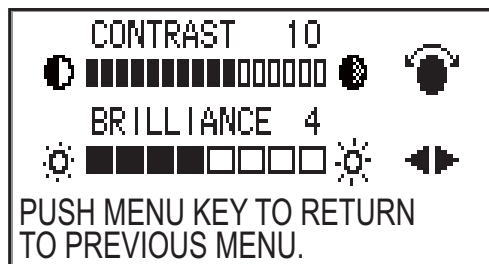

3. Operate the **Course control** knob to adjust the contrast.
4. Operate the ◀ or ▶ key to adjust the brilliance.
5. Push the **Course control** knob to close the screen, or wait several seconds for the screen to close automatically.

## 1.4 Displays in the STBY, AUTO, NAV, WIND and FishHunter™ Modes

There are four (NAVpilot-700) or five (NAVpilot-711, NAVpilot-720) displays to select from in the STBY mode. For Fantum Feedback™, there are three display (NAVpilot-711, NAVpilot-720) to select. To select a display, press the **STBY** key, **AUTO** key or **NAV** key continuously to step through the displays.

### 1.4.1 Content of displays in the STBY, AUTO, NAV, WIND and Fish-Hunter™ modes

#### NAVpilot-700

- Autopilot Display 1 (Digital course and heading, and rudder angle or heading deviation)
- Autopilot Display 2 (Digital course and heading, rudder angle or heading deviation, and one or two nav data displays)
- Nav Data Display (Digital course and heading, and two or three digital nav displays)
- Graphic Display (Digital course and heading, and graphic display)
- Press the **STBY** key to show the displays in the STBY mode.

**Note 1:** For the WIND mode, the wind deviation replaces the heading deviation.

**Note 2:** The rudder angle can not be selected in case of Fantum Feedback™.

**Note 3:** The number of boxes depends on setting of DATA BOX FORMAT in the DISPLAY SETUP menu in the INSTALLATION menu.

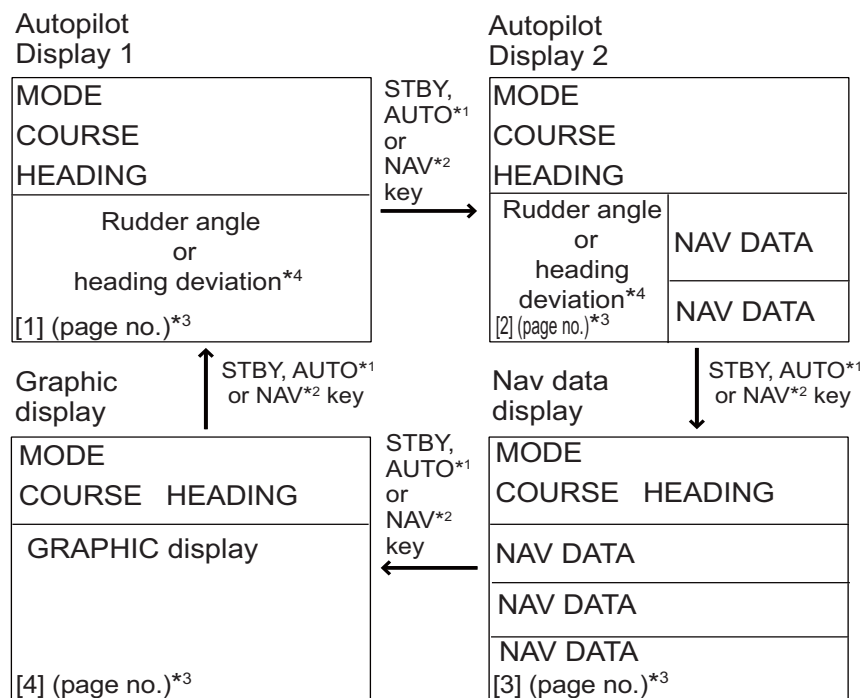

\*1 AUTO or WIND mode

\*2 NAV or FishHunter™ mode

\*3 Page no. appears when selecting display.

\*4 See Note1 and Note2 as above.

*Displays (NAVpilot-700)*

1. INTRODUCTION

**NAVpilot-711, NAVpilot-720**

**When the rudder reference unit is installed**

- Autopilot Display 1 (Digital course and heading)
- Autopilot Display 2 (Digital course and heading, and rudder angle or heading deviation)
- Nav Data Display 1 (Digital course and heading, rudder angle or heading deviation, and one nav data display)
- Nav Data Display 2 (Digital course and heading, and one or two digital nav data display)
- Graphic Display (Digital course and heading, and graphic display)
- Press the **STBY** key to show the displays in the STBY mode.

**Note 1:** For the WIND mode, the wind deviation replaces the heading deviation.

**Note 2:** The rudder angle can not be selected in case of Fantum Feedback™.

**Note 3:** The number of boxes depends on setting of DATA BOX FORMAT in the DISPLAY SETUP menu in the INSTALLATION menu.

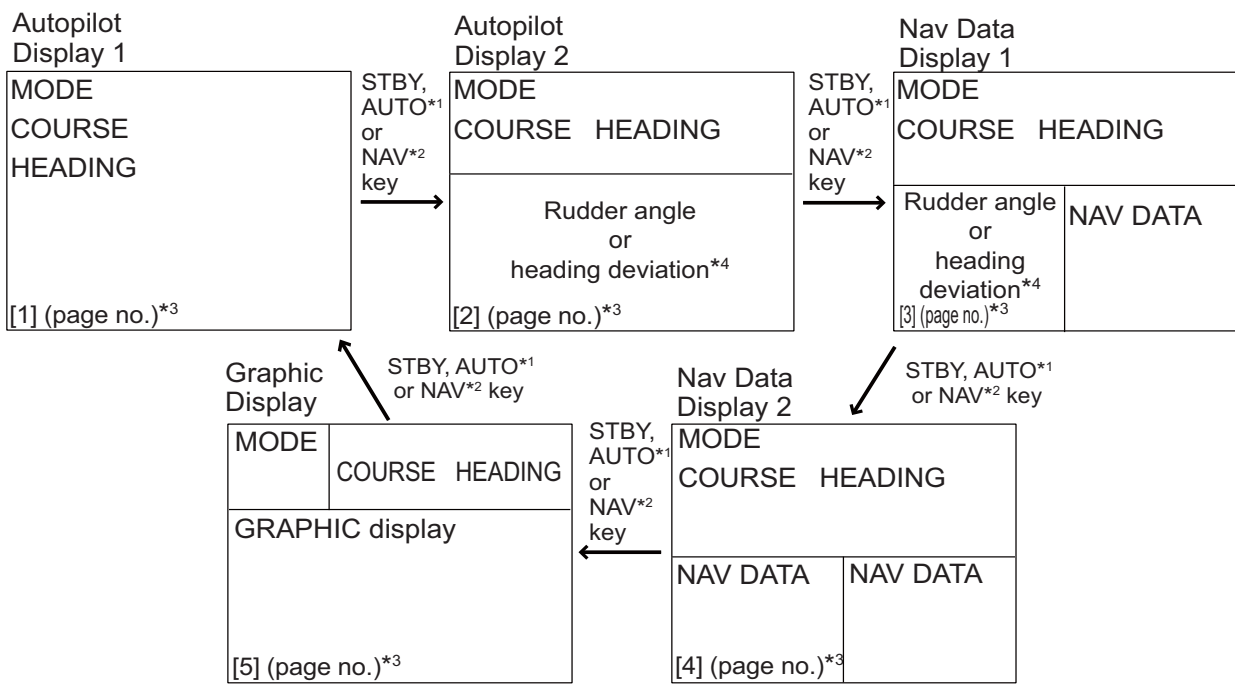

\*1 AUTO or WIND mode  
 \*2 NAV or FishHunter™ mode  
 \*3 Page no. appears when selecting display.  
 \*4 See Note 1 and Note 2 as above.

*Displays when the RRU is installed (NAVpilot-711, 720)*



**For Fantum Feedback™**

- Autopilot Display 1 (Digital course and heading)
- Nav Data Display 2 (Digital course and heading, and one or two digital nav data display)
- Graphic Display (Digital course and heading, and graphic display)
- Press the **STBY** key to show the displays in the STBY mode.

**Note:** The number of boxes depends on setting of DATA BOX FORMAT in the DISPLAY SETUP menu in the INSTALLATION menu.

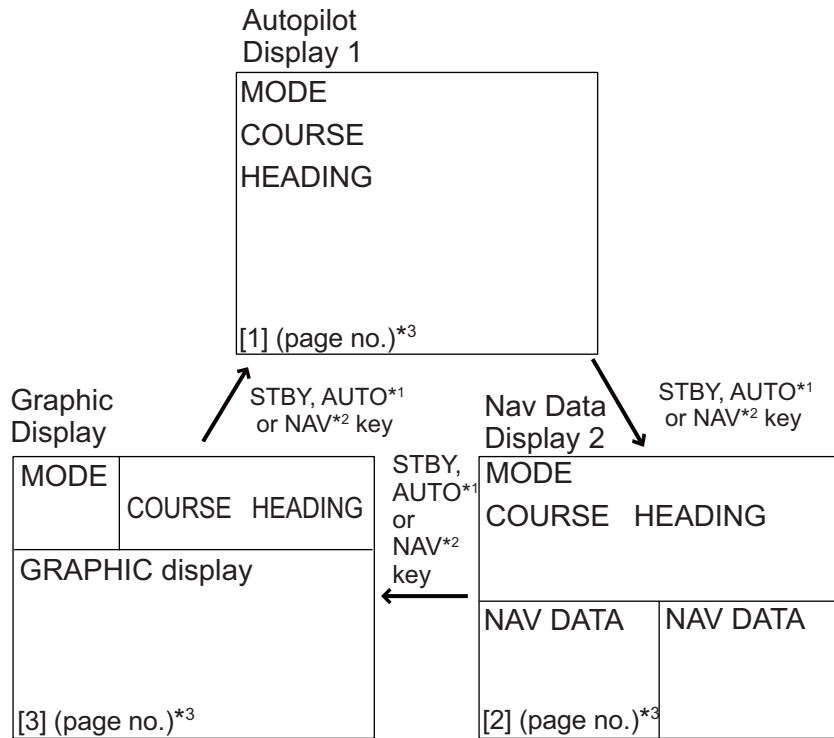

\*1 AUTO or WIND mode

\*2 NAV or FishHunter mode

\*3 Page no. appears when selecting display.

## 1. INTRODUCTION

### **Available displays**

The table below shows all the nav data and graphic displays available. Appropriate sensors are required.

<b>Data displayed</b>	<b>Data meaning</b>
<b>Nav data displays</b>	
AIR TEMP	Air temperature
ATMOS PRESS	Atmospheric pressure
BRG	Bearing to waypoint
COG	Course over ground
DATE	Current date
DEWPOINT	Dewpoint
DPT	Depth
ETA	Estimated time of arrival to waypoint
HUMIDITY	Humidity
POS	Position
RNG	Range to waypoint
SOG	Speed over ground
STW	Speed through water
TEMP	Water temperature
TIME	Current time
TRIP	Trip distance
TTG	Time-to-go to waypoint
VOLT	Input/output voltage to processor unit
WIND APPARENT	Apparent wind direction/speed
WIND TRUE	True wind direction/speed
WPT	Waypoint position (Latitude/Longitude)
XTE	Cross-track error
<b>Graphic displays</b>	
COMPASS, RUDDER* <sup>1</sup>	Compass rose, and analog and digital rudder angle
DEPTH	Analog and digital depth
ENGINE SPEED	Analog engine speed (revolution meter)
HIGHWAY	Graphic presentation of progress towards waypoint
RUDDER* <sup>1</sup>	Analog and digital rudder angle
TEMP	Analog (graph) and digital water temperature
WIND APPARENT	Analog and digital apparent wind direction speed
WIND TRUE	Analog and digital true wind direction speed
<b>Rudder angle, deviation, wind deviation (analog)</b>	
RUDDER* <sup>1</sup>	Rudder angle
DEVIATION* <sup>2</sup>	Heading deviation:
WIND DEV.* <sup>3</sup>	Wind deviation

\*<sup>1</sup> Can not be selected in case of Fantum Feedback™.

\*<sup>2</sup> Any mode other than WIND.

For Fantum Feedback™, NAVpilot-711 and NAVpilot-720 can not display [DEVIATION].

\*<sup>3</sup> WIND mode only

## 1.4.2 Graphic displays

### Compass rose, rudder display

The compass rose and rudder display show ship's heading in graphic form and rudder angle in both analog and digital formats. Requires heading data.

**Note:** Not available with Fantum Feedback™.

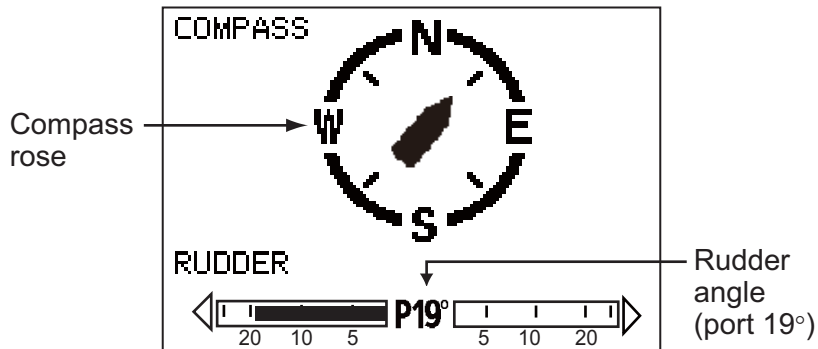

### Depth display

The depth display provides depth data in a graph. Data scrolls across the screen from right to left. Requires depth data.

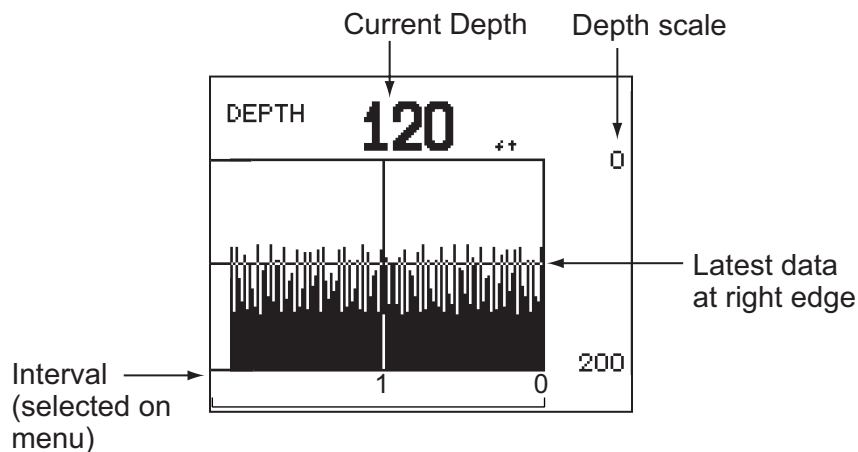

## 1. INTRODUCTION

### Engine speed display

The engine speed display shows the engine revolution. Requires engine speed data.

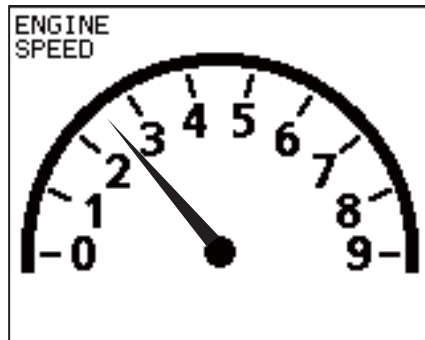

9: 9000 rpm

### Highway display

The highway display provides a graphic presentation of your boat's progress along its intended course. The own ship marker moves according to your boat's track to the waypoint.

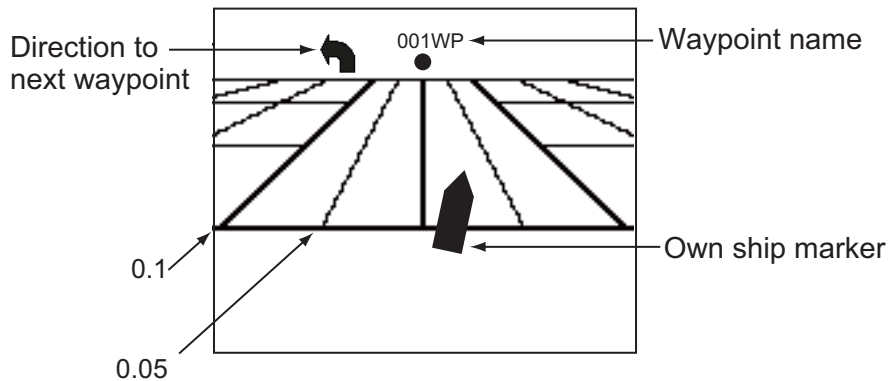

### Rudder display

**Note:** Not available with Fantum Feedback™.

The rudder display shows analog and digital rudder angle.

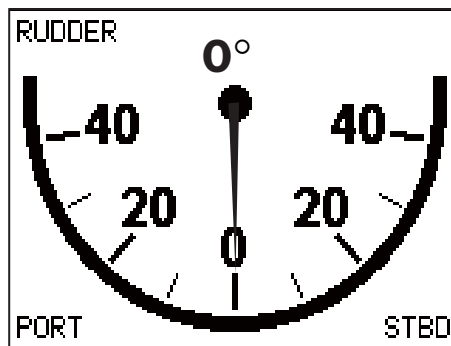

### Water temperature display

The water temperature display shows water temperature over the selected time interval, and the current water temperature. Data scrolls across the screen from right to left. The interval of time can be selected from the menu. Requires water temperature data.

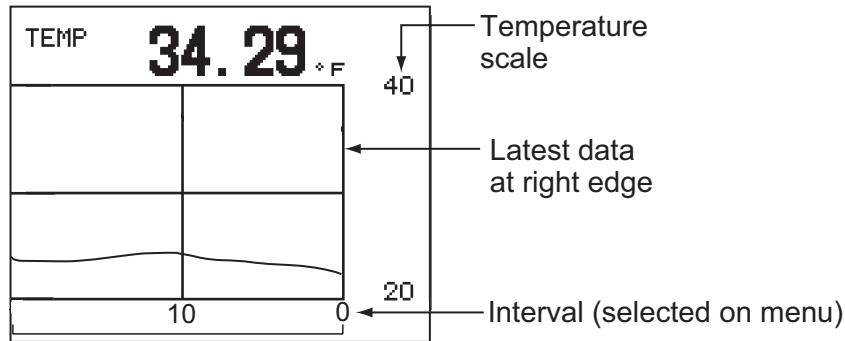

### Wind display

The wind display shows wind angle and wind speed. The data can be shown in true wind or apparent wind. The **apparent wind** is the actual flow of air acting upon a sail, or the wind as it appears to the sailor. The **true wind** is the wind seen by a stationary observer in velocity and direction. Requires a wind sensor.

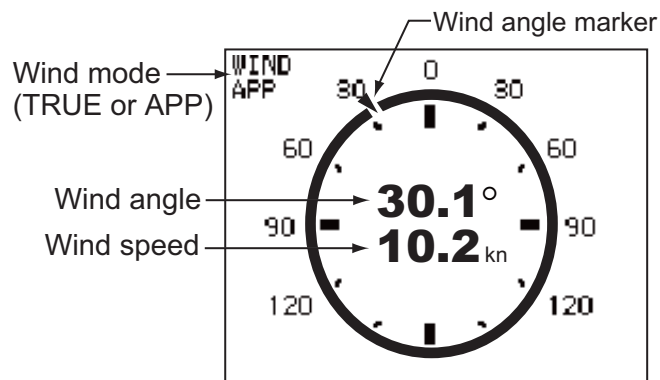

### 1.4.3 How to select the data to show in the STBY mode

You can select the data to show in the STBY mode as follows:

1. Short press the **STBY** key to go to the STBY mode.
2. Press the **STBY** key again to select a display. For example, select the nav data display.

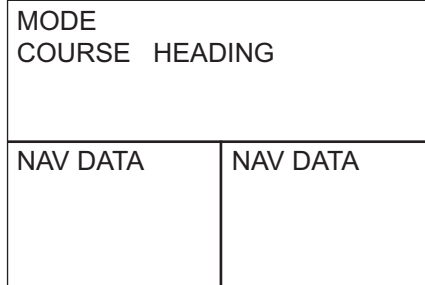

3. Push the **Course control** knob. The item selected by the cursor is circumscribed with a thick rectangle, as in the illustration below.

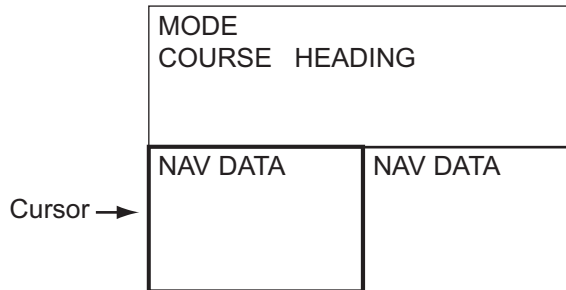

4. For multi-data display, press ◀ or ▶ to put the cursor on the data to change.
5. Rotate the Course control knob to select the data (or graphic) (Graphic displays: Depth graph, Temperature graph, Engine speed, Compass rose, Rudder, Highway, Wind)
6. Push the **Course control** knob.

### 1.4.4 How to select displays from the menu

You can select the nav data or graphic display to show in the STBY, AUTO(WIND) and NAV(FishHunter™) modes.

1. Open the [SYSTEM SETUP] menu, select [DISPLAY DATA SELECT MENU] then push the **Course control** knob.

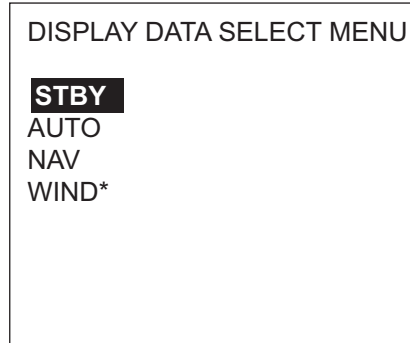

\* Visible when [SHIP'S CHARACTERISTICS]=sailboat

2. Rotate the **Course control** knob to select the mode desired then push the knob. Rotate the knob to select the display division desired then push the knob. The example below shows the display divisions in the STBY, AUTO and NAV modes.

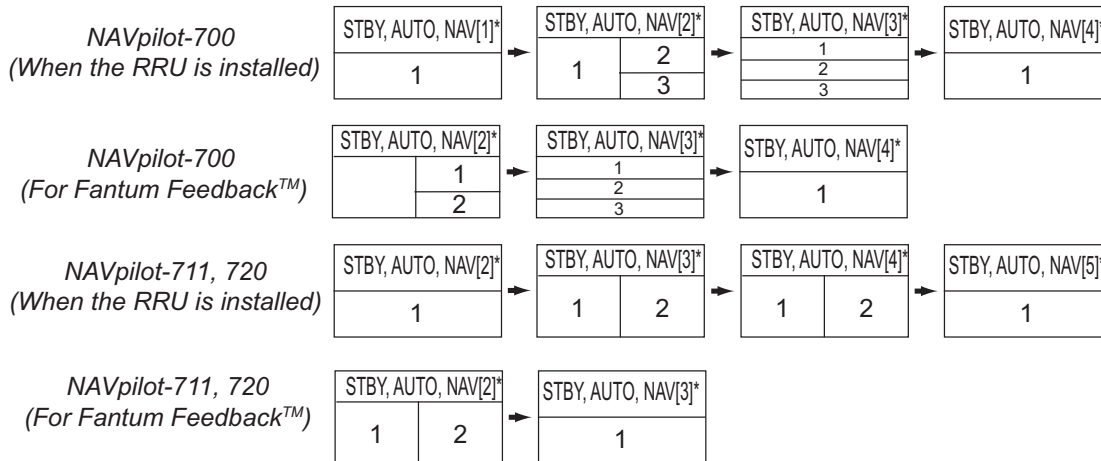

\* "WIND" available when [SHIP'S CHARACTERISTICS]=sailboat

**Note:** The number of boxes depends on setting of DATA BOX FORMAT in the DISPLAY SETUP menu in the INSTALLATION menu.

1. INTRODUCTION

3. Rotate the **Course control** knob to select “1:” or “2:”, “3:” then push the knob. The choices available for each division are as follows:

NAVpilot-700 (When the RRU is installed): 1 of [1], [2]  
 NAVpilot-711, 720 (When the RRU is installed): 1 of [2], [3]

RUDDER DEVIATION
---------------------

Note: For Fantum Feedback™, the display as above is not shown.

NAVpilot-700 (When the RRU is installed): 2 and 3 of [2], 1, 2 and 3 of [3]  
 NAVpilot-700 (For Fantum Feedback™): 1 and 2 of [2], 1, 2 and 3 of [3]  
 NAVpilot-711, 720 (When the RRU is installed): 2 of [3], 1 and 2 of [4]  
 NAVpilot-711, 720 (For Fantum Feedback™): 1 and 2 of [2]

POS COG SOG STW TEMP DPT BRG RNG WPT	▼
--	---

Page 1

XTE TTG ETA DATE TIME WIND TRUE*1 WIND APPARENT*1 VOLT TRIP	▲	▼
---	---	---

Page 2

AIR TEMP ▲ ATMOS PRESS HUMIDITY DEW POINT
--

Page 3

NAVpilot-700: 1 of [4]  
 NAVpilot-711, 720 (When the RRU is installed): 1 of [5]  
 NAVpilot-711, 720 (For Fantum Feedback™): 1 of [3]

COMPASS*2 RUDDER*2 HIGHWAY WIND TRUE*1 WIND APPARENT*1 DEPTH TEMP ENGINE SPEED
---

\*1 Shown when [SHIP'S CHARACTERISTICS]=sailboat  
 \*2 Not shown in case of Fantum Feedback™.

Graphic display

4. Rotate the **Course control** knob to select nav data desired then push the knob.
5. Set other patterns similarly.
6. Press the **MENU** key four times to close the menu.



## 2. STEERING MODES

Your NAVpilot has eight primary steering modes: STBY (manual), AUTO, NAV, TURN, FishHunter™, DODGE, REMOTE (FU and NFU), and WIND (for sailboats).

### 2.1 STBY Mode

After turning on the power, the equipment goes to the STBY mode. This is a manual steering mode. When sailing into or out of a harbor, steer the vessel in the STBY mode by using the steering wheel (helm) of your boat.

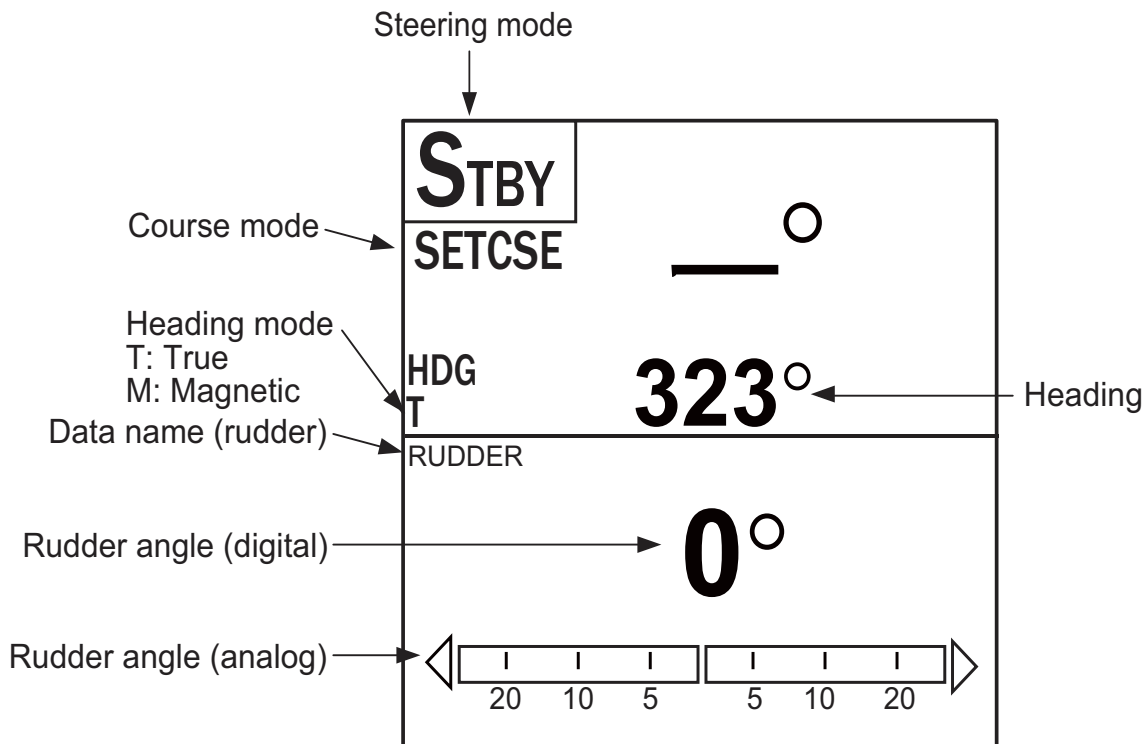

Autopilot display 1 (NAVpilot-700)

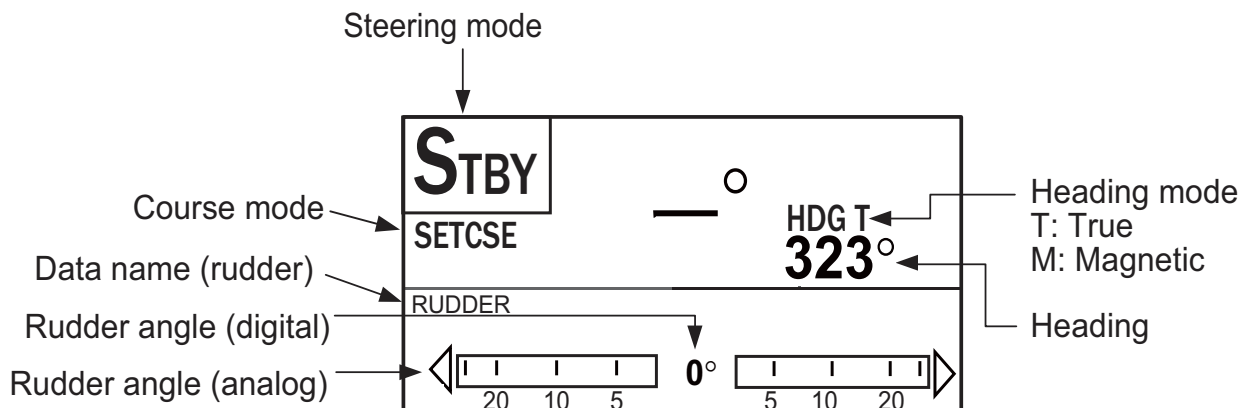

Autopilot display 2 (NAVpilot-711, NAVpilot-720)

## 2.2 AUTO Modes

### 2.2.1 AUTO mode

The AUTO mode steers the boat automatically on a course set by the operator.

The AUTO mode will not compensate for the effects of wind or tide, which can push you off course athwart in the ship direction. Use the AUTO mode for short, straight voyages. Otherwise switch to the NAV mode.

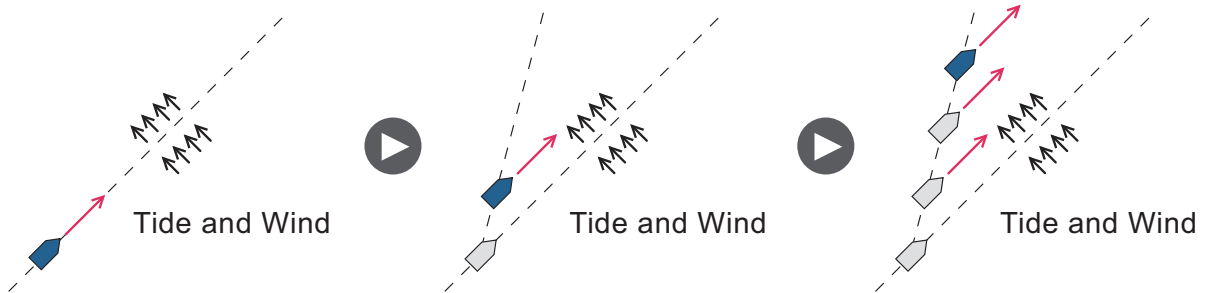

To get the AUTO mode, do as follows:

1. Direct the boat toward required course.
2. Press the **AUTO** key to activate the AUTO mode.  
Your boat automatically maintains the current course when the **AUTO** key is pressed.  
When the heading changes from the set course, the NAVpilot automatically adjusts the rudder to return the boat to the set course.
3. To change the course setting in the AUTO mode, rotate the **Course control** knob to the required course.

4. To exit the AUTO mode to steer manually, press the **STBY** key. Steer your boat by the helm.

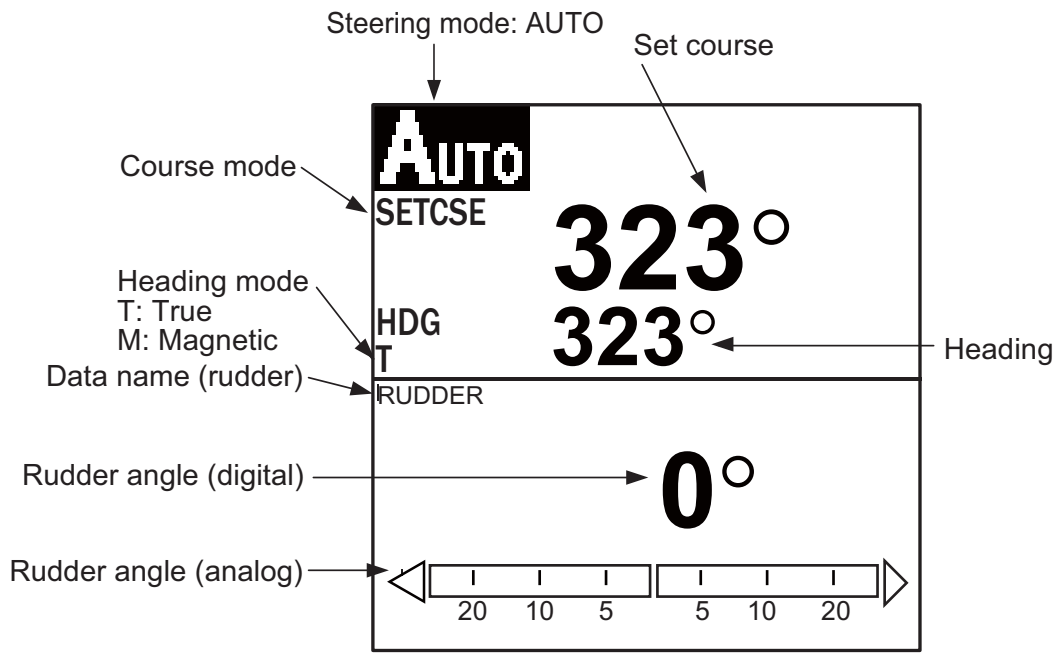

Autopilot display 1 (NAVpilot-700)

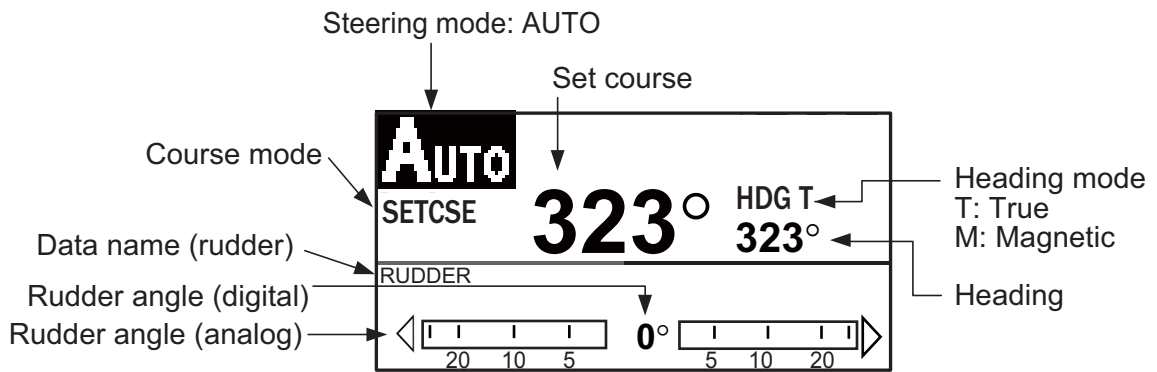

Autopilot display 2 (NAVpilot-711, NAVpilot-720)

### 2.2.2 ADVANCED AUTO mode

The AUTO mode keeps a set course, but your boat's course can change by the effects of tide and wind. To adjust for the effects of tide and wind, use the ADVANCED AUTO mode. The NAVpilot calculates your course according to your current position and heading, then sets a virtual "waypoint" in its memory to navigate towards. If either tide or wind begins to push you off course, the NAVpilot corrects your heading accordingly.

Your NAVpilot must be connected to a GPS navigator which outputs position data (Latitude and Longitude).

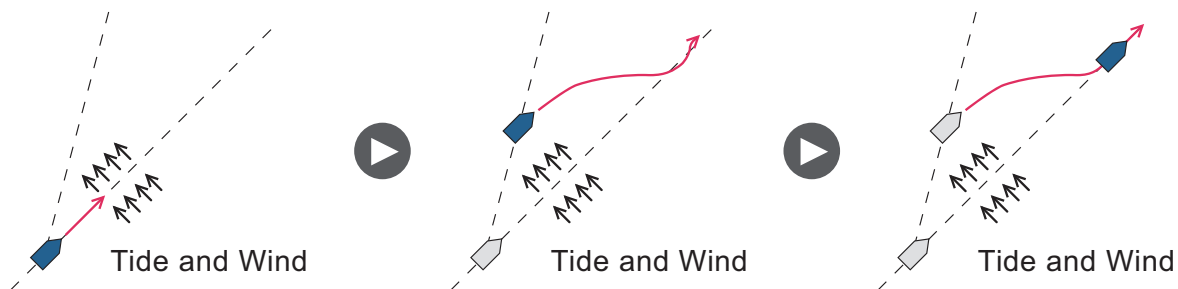

To get the ADVANCED AUTO mode, do as follows:

1. In the AUTO mode, press the **MENU** key to show the menu.
2. Rotate the **Course control** knob to select [ADVANCED AUTO] then push the **Course control** knob to show the advanced auto options window.



3. Rotate the **Course control** knob to select [ON]. The steering mode display changes as below.



Select [OFF] to quit the ADVANCED AUTO mode.

4. Push the **Course control** knob to confirm the setting.
5. Press the **MENU** key to close the menu.

You can switch between AUTO and ADVANCED AUTO modes by holding down the **AUTO** key three seconds to show the message "ADVANCED AUTO ON (OFF)" appears.

**Note:** How strictly the ADVANCED AUTO mode keeps the course depends on the NAV MODE setting in the NAV OPTION menu. COURSE/XTE(ECONOMY) keeps the course within 0.03 NM and XTE(PRECISION) keeps the course within 0.01 NM.

## 2.3 NAV Mode

NAVpilot steers the vessel towards the current waypoint while compensating for the effects of tide and wind.

When connected to a GPS Navigator, NAVpilot steers the vessel to follow a series of waypoints in sequence. When you arrive at each waypoint or destination, audible and visual alerts are activated.

The NAVpilot takes 15 seconds to activate the NAV mode after the NAVpilot receives the destination information.

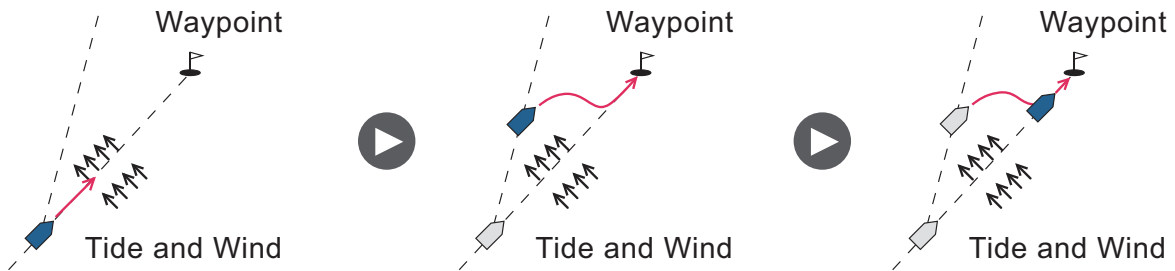

*Steering to a single waypoint*

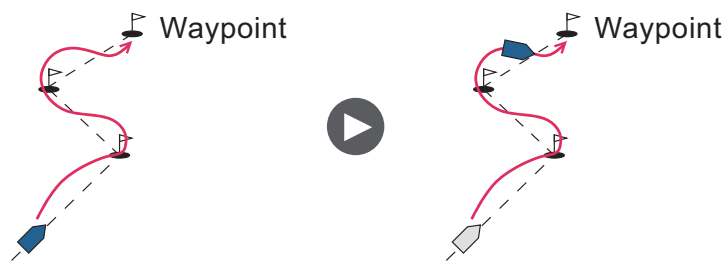

*Steering a route (a series of waypoints)*

### 2.3.1 How to get the NAV mode

To get the NAV mode, do as follows:

1. Set the destination waypoint (or route) on the GPS navigator or chartplotter. (To navigate a route, make sure that your plotter is navigating towards the nearest or required waypoint before you put the NAVpilot into the NAV mode.)
2. Manually steer the boat toward the waypoint.
3. Press the **NAV** key.
4. You are asked if you are sure to navigate to the waypoint selected. Push the **Control course** knob to start to navigate to the waypoint.

**Note 1:** The course reading on the NAVpilot is not always the same as the waypoint direction shown on the chartplotter.

**Note 2:** You can switch between nav data sources (for example, one source fails) by pressing the **NAV** key three seconds. (This feature is not available when [BOTH] is selected as nav data source on the [NAV DATA SOURCE] menu, set during the installation.)

## 2. STEERING MODES

### NAV mode, "COURSE" setting

**Note:** "COURSE" is not available with Fantum Feedback™.

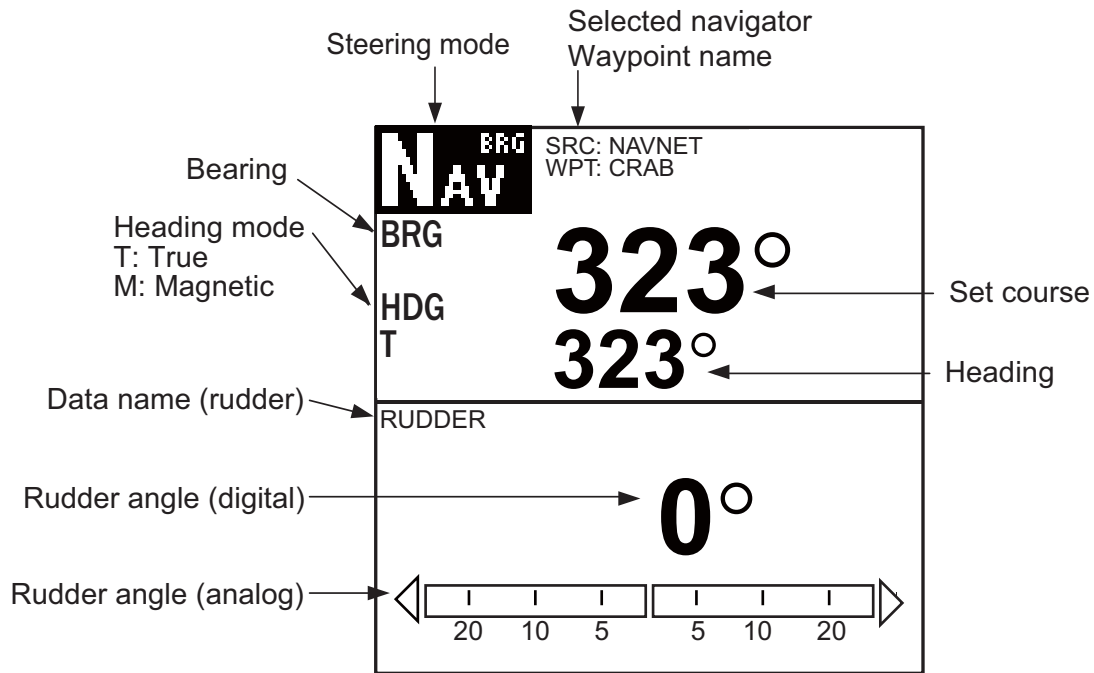

Autopilot display 1 (NAVpilot-700)

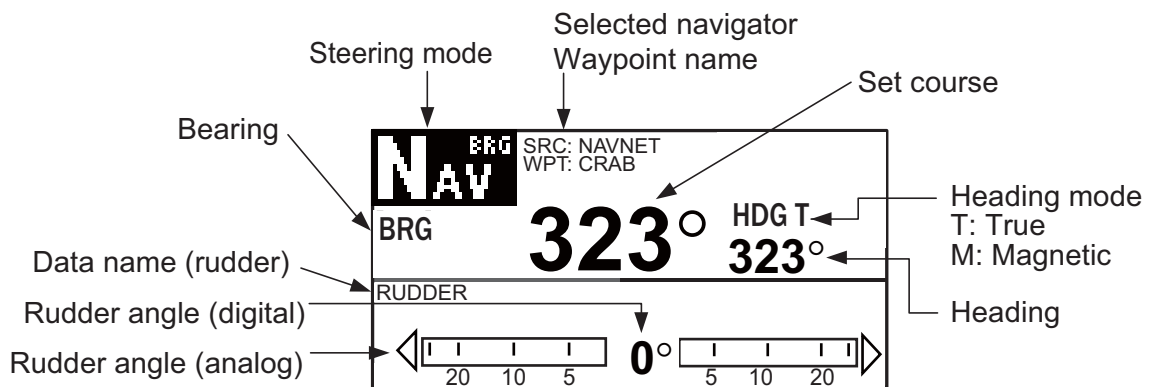

Autopilot display 2 (NAVpilot-711, NAVpilot-720)

**NAV mode. "ECONOMY", "PRECISION" setting**

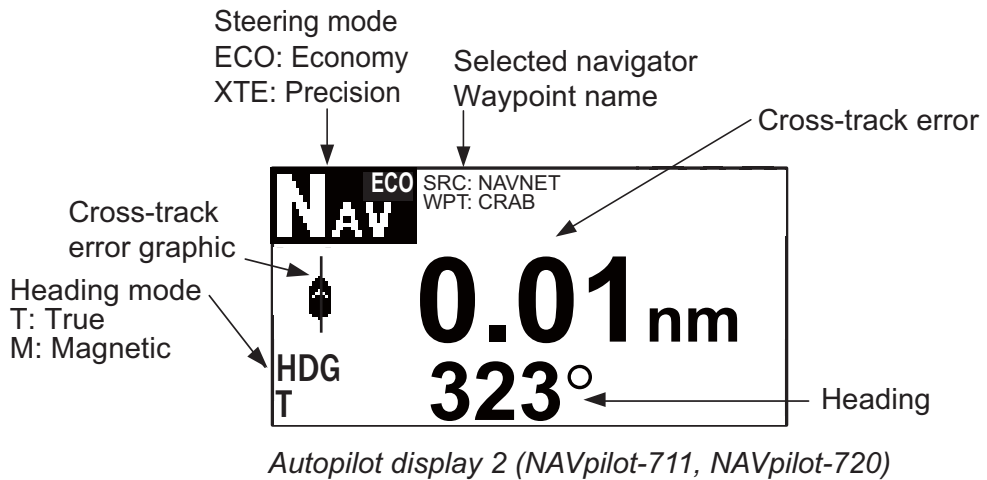
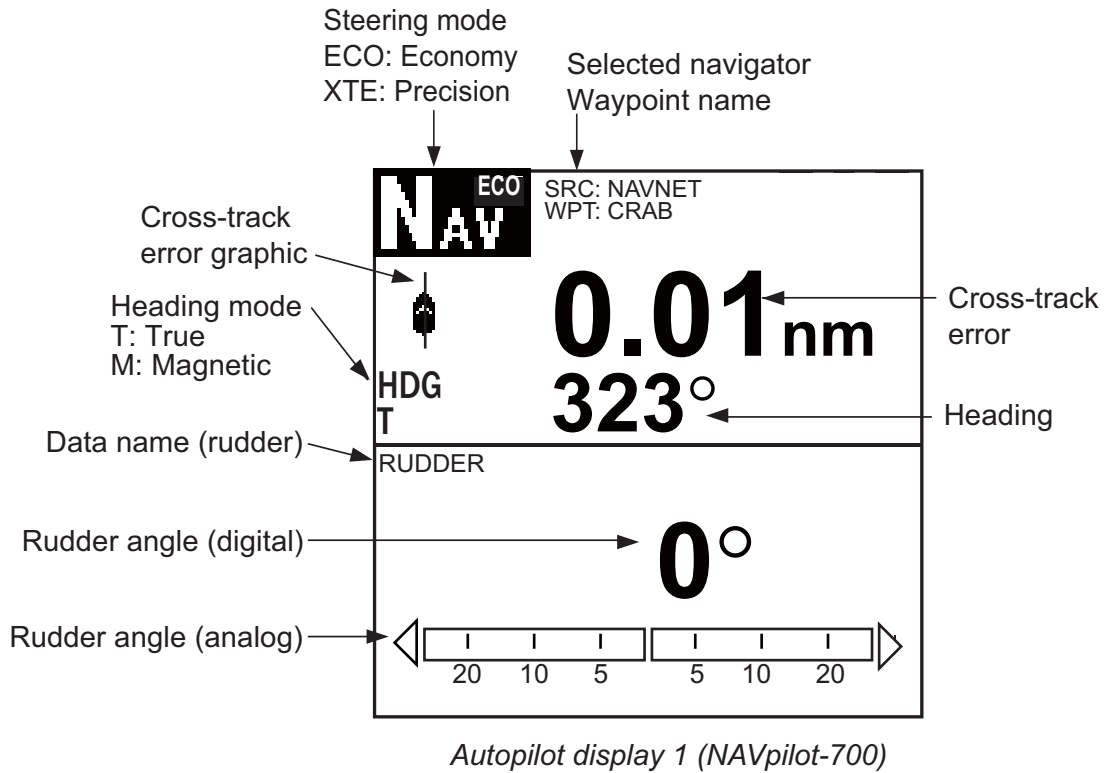

### 2.3.2 Sailing method for the NAV mode

Your vessel can go off course between waypoints in the NAV mode. This can occur when, for example, a command is received from a remote controller. To return to the course set, three methods are available: [COURSE], [XTE (PRECISION)], and [XTE (ECONOMY)]. For [COURSE], the NAVpilot calculates a new course according to your new position, after dodging, etc. that takes you directly to your destination waypoint. [XTE (PRECISION)] and [XTE (ECONOMY)] both use the XTE (cross-track error) value to steer the boat towards your ORIGINAL course before dodging. PRECISION provides for tighter course keeping, within 0.01 nm of the set course. ECONOMY gives less tighter course keeping, within 0.03 nm of the set course.

**Note:** [COURSE] is not available with Fantum Feedback™.

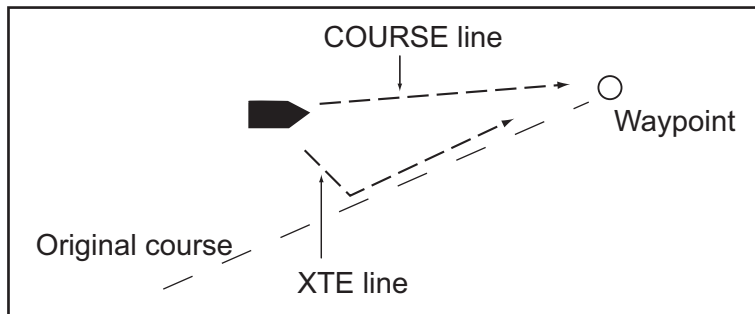

Select COURSE or one of the XTE selections as shown below.

1. In the NAV mode, press the **MENU** key to show the menu.
2. Rotate the **Course control** knob to select [OTHER MENU] then push the knob.
3. Rotate the **Course control** knob to select [NAV OPTION] then push the knob.
4. Rotate the **Course control** knob to select [NAV MODE] then push the knob to show the NAV mode options window.



\*: Not shown with Fantum Feedback™.

5. Rotate the **Course control** knob to select an option then push the knob.
6. Press the **MENU** key three times to close the menu.



### 2.3.3 Waypoint switching method

When you arrive at a waypoint on a route in the NAV mode, you can switch to the next waypoint automatically or manually.

The AUTO setting switches to the next destination waypoint when your boat is within the arrival alarm area (set on the chartplotter). When your boat is within the arrival alarm area, the buzzer sounds for five seconds and the message "WPT WAS CHANGED" appears.

The MANUAL setting requires operator confirmation (pushing the **Course control** knob) before switching to the next waypoint. For manual switching, the NAVpilot sounds a five-second alarm when the vessel arrives at the destination waypoint. The message "PUSH ANY KEY TO TURN." appears. Push any key. Then, the message "WPT WAS CHANGED." appears.

Select waypoint switching method as follows:

1. In the NAV mode, press the **MENU** key to show the menu.
2. Rotate the **Course control** knob to select [OTHER MENU] then push the knob.
3. Rotate the **Course control** knob to select [NAV OPTION] then push the knob to show the related options window.
4. Rotate the **Course control** knob to select [WAYPOINT SWITCHING] then push the knob to show the waypoint switching options window.
5. Rotate the **Course control** knob to select an option then push the knob.
6. Press the **MENU** key three times to close the menu.



### 2.3.4 How to set the steering behavior of your boat after you arrive to a waypoint

The FishHunter™ mode can be enabled and set up control of the steering behavior of your boat after it reaches the last waypoint in a route. You can choose from orbit, figure eight or square. For details of each movement, see section 2.6. This function is not available when [BOAT CHARACTERISTICS] (on the Installation menu) is set for [SAILBOAT].

To enable the FishHunter™ mode and set the steering behavior, do as follows:

1. In the NAV mode, press the **MENU** key to show the menu.
2. Rotate the **Course control** knob to select [OTHER MENU] then push the knob.
3. Rotate the **Course control** knob to select [NAV OPTION] then push the knob.
4. Rotate the **Course control** knob to select [AFTER ARRIVAL] then push the knob to show the after arrival options window.
5. Rotate the **Course control** knob to select an option then push the knob.
6. Press the **MENU** key three times to close the menu.

**Note:** For Fantum Feedback™, only [GO STRAIGHT] and [ORBIT TO STBD] appear.

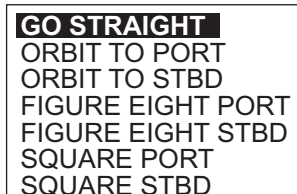

## 2.4 Response Feature

The Response feature provides for simple setting of the NAVpilot's parameters. This is useful when you need a quick adjustment to counter the effects of wind, etc. This feature is available in the following conditions:

- AUTO, NAV, WIND and FishHunter™ modes
- Sea State is set for FULL-AUTO or SEMI-AUTO

### 2.4.1 How to activate and set the response feature

1. Push the **Course control** knob to show the RESPONSE window.

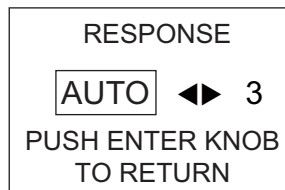

2. Push the ► key to show the following window.

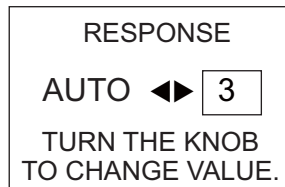

3. Rotate the **Course control** knob to set response level, 1-9. Clockwise rotation: Raise the response level to get back on course when external interference (wind, etc.) is pushing the boat off course. Counterclockwise rotation: Lower the response level when the NAVpilot is oversteering the rudder.
4. Push the **Course control** knob to confirm your setting and close the window.

### 2.4.2 How to deactivate the response feature

1. Push the **Course control** knob to show the RESPONSE window.
2. Push the ◀ key to select [AUTO].
3. Push the **Course control** knob to close the window.

## 2.5 TURN Mode

The TURN mode provides three preset turning motions: 180°, 360°, and User. These turns are available in the AUTO mode and in clockwise and counterclockwise directions.

For the User turn, you can confirm and change the parameters of the turn before you do the turn. If confirmation or change is not necessary in these turns, simply push the **Course control** knob after selecting the turn with the **TURN** key.

This function is not available when [SHIP'S CHARACTERISTICS] (on the Installation menu) is set for [SAILBOAT].

### 2.5.1 How to select a turn and start the turn

Select the 180°, 360°, or User turn as follows:

1. Press the **TURN** key to show the Turn menu.

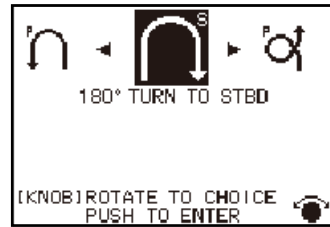

NAVpilot-700



NAVpilot-711/NAVpilot-720

2. Rotate the **Course control** knob to select a turn. The cursor highlights current selection. See the next section for description of turns.

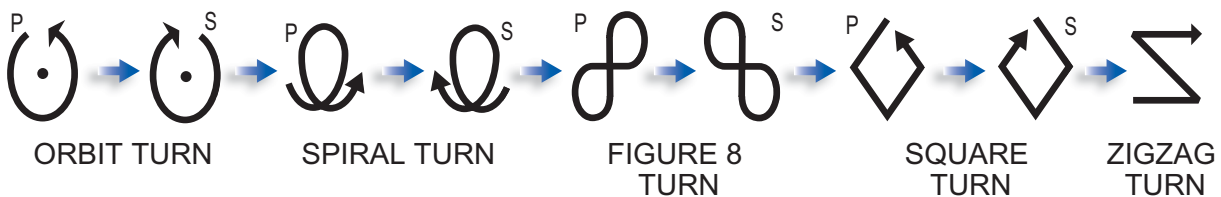
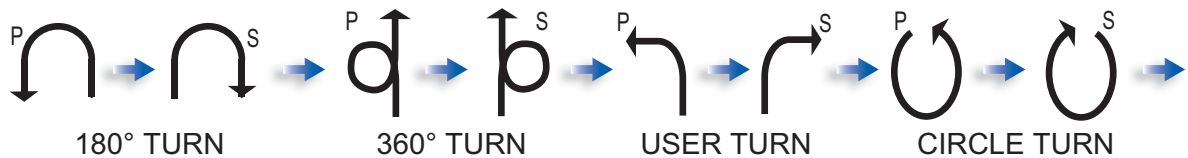

**Note 1:** You can set the parameters for the User turn (before starting the turn) by pressing the ► key. For details, see section 2.5.4.

**Note 2:** Only [180° TURN], [360° TURN], and [USER TURN] are available with Fantum Feedback™.

3. Push the **Course control** knob to start the turn.

After you start the turn, the steering mode indications shows "XXXT" (XXX=turn angle), the message "BEGINNING TURN" appears, and the buzzer sounds. After the turn is completed, the message "THE TURN ENDED" appears.

To escape from a turn, press the **STBY** key.

## 2. STEERING MODES

### 2.5.2 180° turn

This function changes the current set course by 180° in the opposite direction. This feature is very useful in a man overboard situation and whenever you want to steer back on a reciprocal heading.



### 2.5.3 360° turn

This function also provides a continuous turn feature with a constant rate of turn in a circle. This feature is useful in purse seining.



### 2.5.4 User turn

You can set desired turn angle with this turn, from 15° to 360° in 15° degree increments.

#### **How to set the turn angle for the user turn and start the turn**

1. Select [USER TURN TO PORT] or [USER TURN TO STBD] from the Turn menu.
2. Press the ► key.



3. The cursor is selecting the value for [TURN ANGLE]; push the **Course control** knob.
4. Rotate the **Course control** knob to set the turn angle then push the knob.
5. To start the turn, rotate the **Course control** knob to select [RUN] then push the knob.

## 2.6 FishHunter™ Mode

The FishHunter mode is a unique feature of FURUNO's NAVpilot series. Find a fish target with your FURUNO sonar/sounder or bird target with your FURUNO radar and feed it to the NAVpilot. The NAVpilot will activate the FishHunter™ mode to perform circle, orbit, spiral, figure eight, square or zigzag maneuvers around the specified target.

Like with the user turn, you can confirm and change the parameters of a FishHunter turn before you make the turn. If confirmation or change is not necessary, simply push the **Course control** knob after selecting the turn with the **TURN** key.

After you start the turn, the steering mode indication changes as shown in the table below, and the buzzer sounds.

**Note:** This function is not available when [SHIP'S CHARACTERISTICS] (on the Installation menu) is set for [SAILBOAT], or the RRU is not installed (Fantum Feedback™).

Turn name	Turn mode indication
Circle	CRCL
Orbit	ORBT
Spiral	SPRL AUTO, SPRL NAV, SPRL TLL
Figure-eight	FIG8
Square	SQRE
Zigzag	ZGZG

### 2.6.1 How to preset FishHunter™ turn parameters

You can preset the parameters for the FishHunter™ turns as follows:

1. Press the **MENU** key to open the menu.
2. Rotate the **Course control** knob to select [OTHER MENU] then push the knob.
3. Rotate the **Course control** knob to select [FISH HUNTER OPTION] then push the knob.

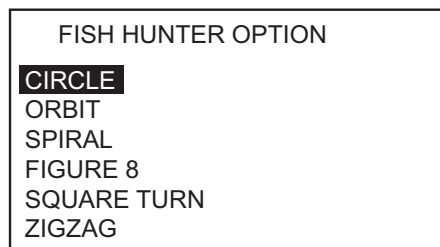

4. Set the parameters for each turn referring to the figure on the next page.

## 2. STEERING MODES

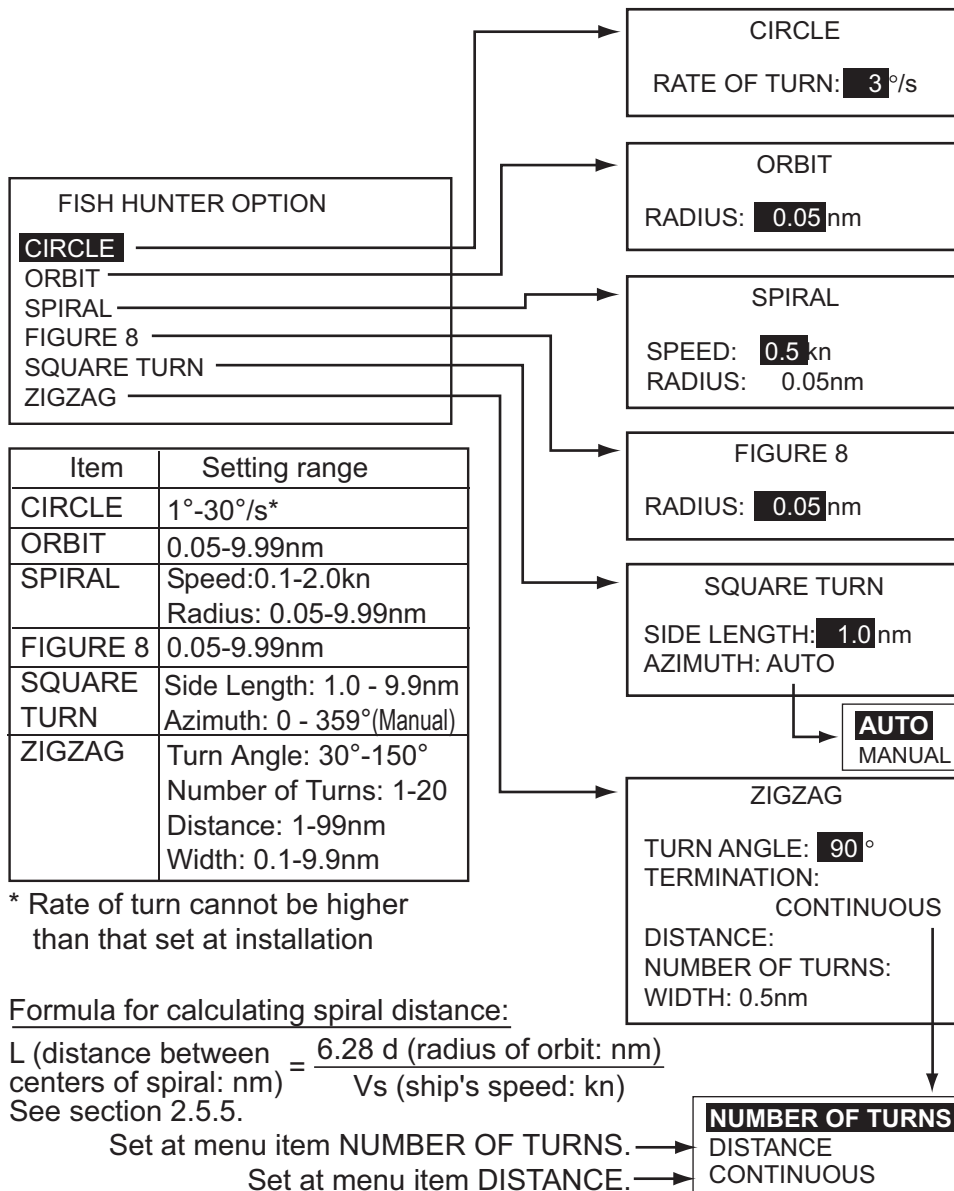

### 2.6.2 How to select a FishHunter™ turn and start the turn

1. Press the **TURN** key to show the Turn menu.

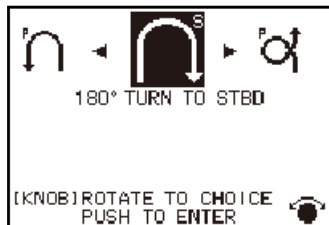

2. Rotate the **Course control** knob to select a FishHunter™ turn. The cursor highlights current selection.

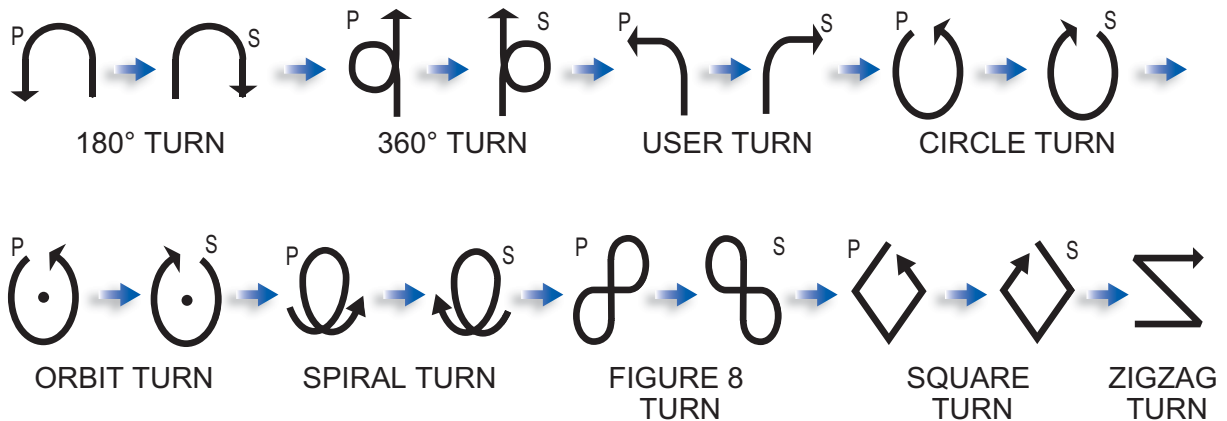

3. If you want to change the parameters for the turn, do 1) - 3) below. If you do not need to change the parameters, push the **Course control** knob to start the turn.
  - 1) Press the ► key to show the setting menu for the turn. See section 2.5.5 for details.
  - 2) Use the **Course control** knob to set the parameters.
  - 3) Select [RUN] then push the knob to start the turn.

The message "START TO TURN BY FISHING MODE" appears, then your boat starts the turn selected.

The orbit and spiral turns require that the speed of the boat be less than 10 knots. If the speed is higher, the message "TOO FAST TO GO TO FISHING MODE." appears. Reduce boat's speed to less than 10 knots.

After the turn is completed, the message "THE TURN ENDED" appears.

To escape from the turn, press the **STBY** key.

### 2.6.3 Circle turn

The circle turn can be used for circling fish or a particular object on the seabed. The rate of turn for the circle can be selected on the menu, but it cannot be higher than that set at installation.

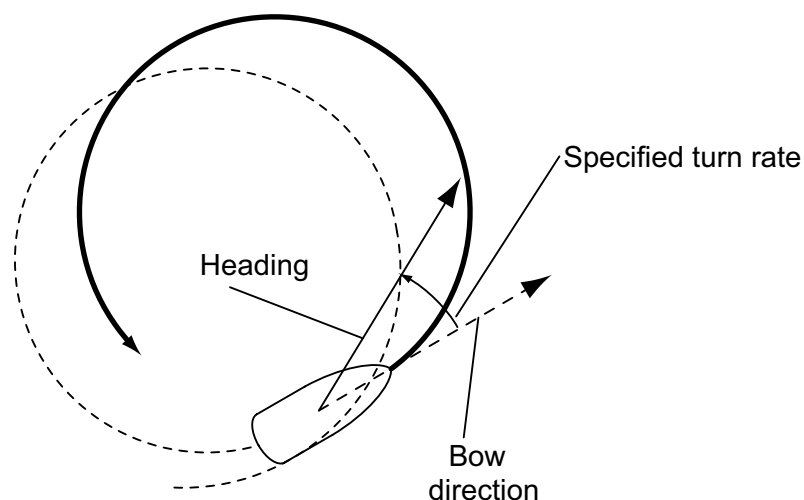

### 2.6.4 Orbit turn

In the AUTO mode, your boat orbits around its current position. For the NAV mode, the boat orbits around the (last) waypoint. This function requires a chartplotter or GPS navigator.

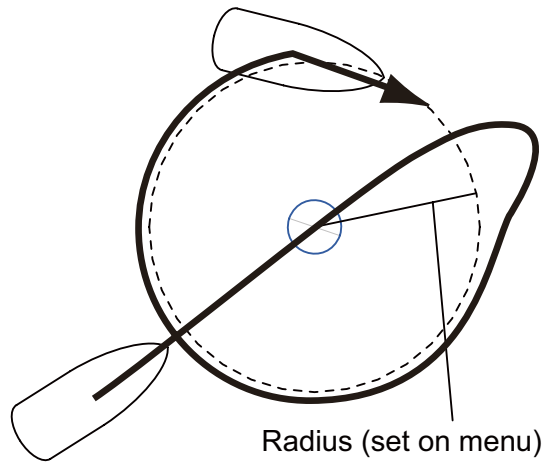

### 2.6.5 Spiral turn

The boat spirals in the direction of current heading (STBY), set course (AUTO) or the course to the next waypoint (NAV) that was active at the moment that the spiral turn is started. The spiral speed can be set in the menu. In the NAV mode, the boat steers toward the waypoint(s) spirally. The arrival alarm must also be active on the chartplotter.

The boat will continue to spiral until the **AUTO** or **STBY** key is pressed.

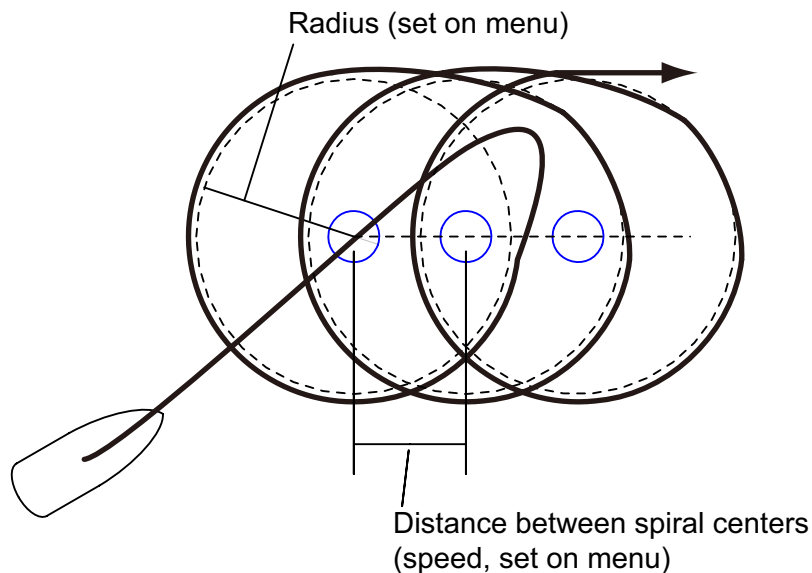

**Note:** If the boat does not enter the arrival alarm area, the NAVpilot does not switch to the next waypoint. To prevent this, set the arrival alarm range as large as possible and activate the perpendicular function on the chartplotter.



### 2.6.6 Figure-eight turn

After the boat has traveled the distance "d" set on the menu, it starts turning in a figure-eight pattern, automatically returning to the position where the figure-eight was initiated. "d", the radius, is set on the menu.

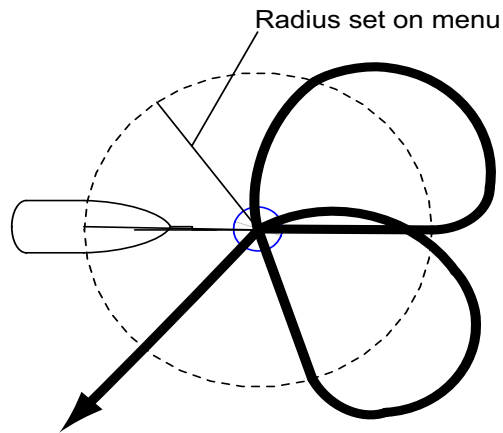

### 2.6.7 Square turn

The square turn is started from a waypoint. You can set length of the sides and the azimuth on the menu.

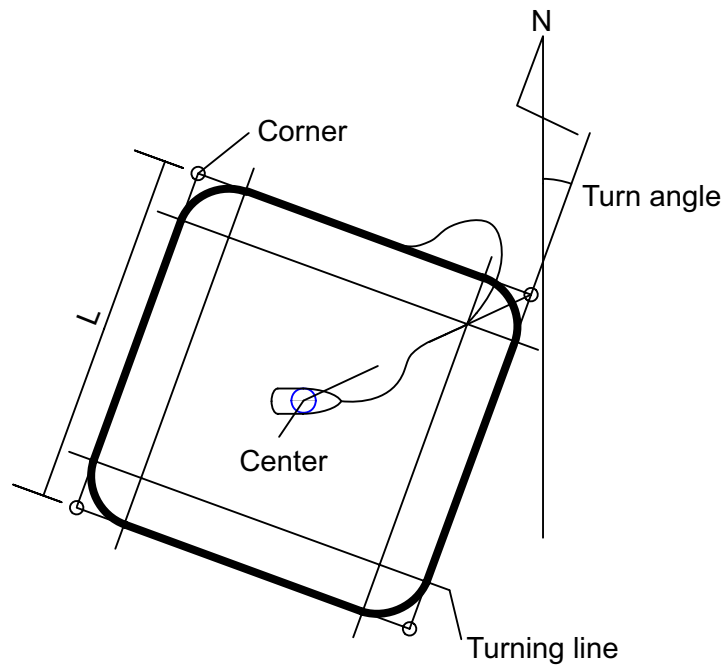

### 2.6.8 Zigzag turn

The zigzag turn starts from current position. The distance between legs, turn angle, number of turns and how to stop the zigzag turn can be set on the menu. This turn is available in the AUTO and NAV modes.

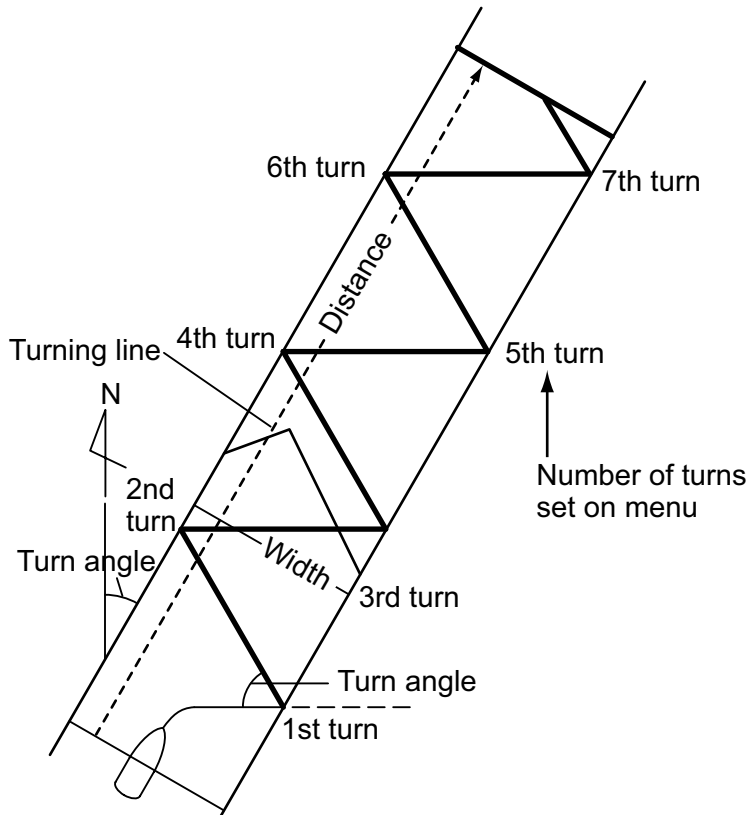

## 2.7 How to Navigate to a TLL Position

The moment TLL (Target Latitude and Longitude) data is input from a radar or echo sounder in the STBY, AUTO or NAV mode, a dialog box appears (other than sailboat). You may choose how to progress towards that position, from nav mode, spiral and zigzag. (You may also continue current steering mode, by choosing [CANCEL].) This mode requires position data and waypoint position data.

**NAV mode:** The boat goes to the TLL by the NAV mode.

**Spiral:** The boat goes to the TLL point in a spiral pattern.

**Zigzag:** The boat follows a zigzag pattern to the TLL.

**Note:** [Spiral] and [Zigzag] are not available with Fantum Feedback™.

## 2.8 REMOTE Mode

Four types of optional remote controllers can be connected to your NAVpilot to control the NAVpilot from a remote location.

**Note:** Remote controllers are not available with Fantum Feedback™.

### 2.8.1 Dial-type remote controller (FAP-5551, FAP-5552)

These are FU-type remote controllers, and they can be used in the AUTO and NAV modes. The rudder moves until operation of the remote controller is stopped.

1. Turn the switch on the remote controller to show "FU RC" (Remote Controller) on the control unit. If the remote controller switch is turned on when in the STBY mode, a beep sounds to alert you that the remote mode is not available.

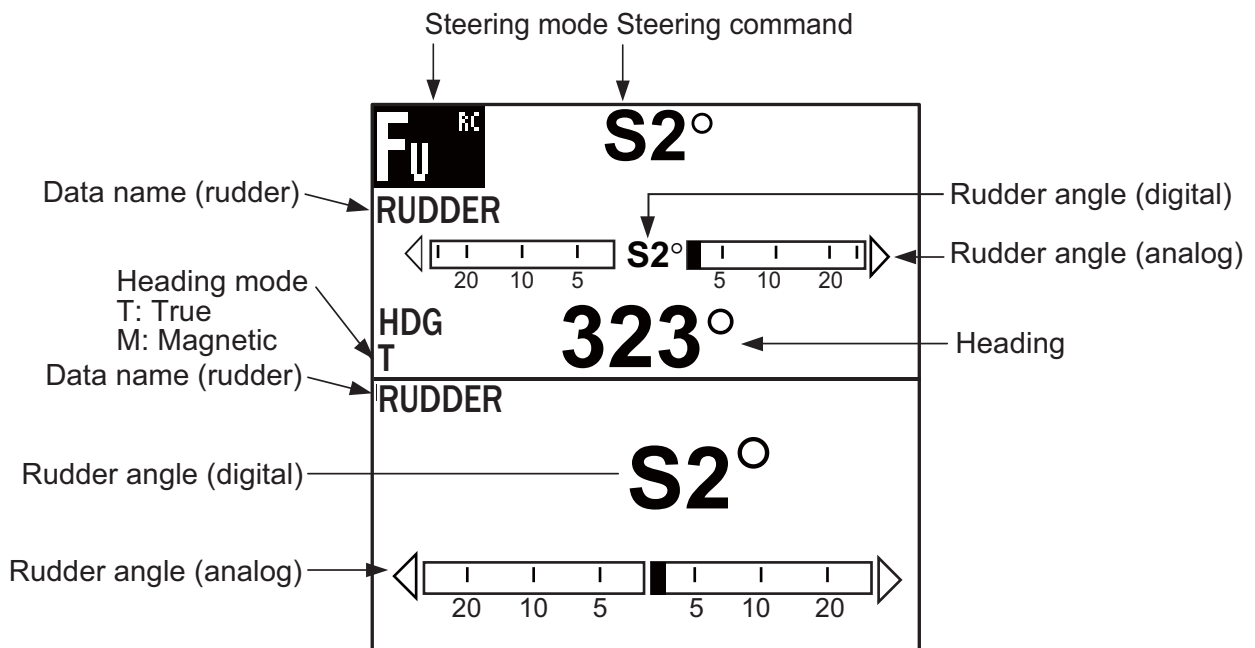
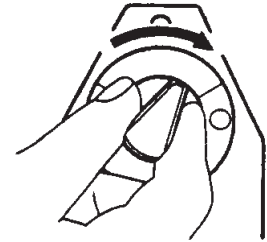

2. Rotate the dial on the remote controller to set the rudder angle.

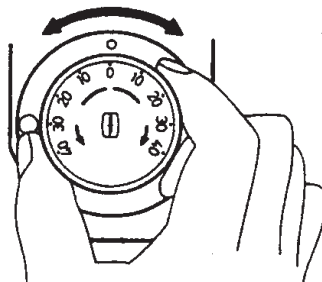

## 2. STEERING MODES

3. To turn off the REMOTE mode, turn off the remote controller

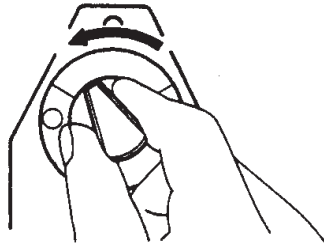

Control is returned to the main control unit and the mode that was originally active (AUTO or NAV) is restored. For the NAV mode, the boat will go to the destination way-point based on the (COURSE or XTE) nav steering method menu setting.

### 2.8.2 Button-type remote controller (FAP-6211, FAP-6212), Dodge-type remote controller (FAP-6231, FAP-6232), Lever-type remote controller (FAP-6221, FAP-6222)

These controllers can be used in the STBY, AUTO and NAV modes. (The dodge-type controller is not shown.)

The button-type controller has an ON/OFF switch and works like an NFU remote controller and a dodge remote controller. In the NFU mode the user operates the remote controller to move the rudder and the rudder stops once operation of the remote controller is stopped. The dodge-type remote controller sets your course and the rudder is moved to steer the set course.

1. For button-and lever-type remote controllers, turn on the remote controller. The dodge-type remote controller doesn't have a power switch, it can be operated by simply pressing the direction buttons.

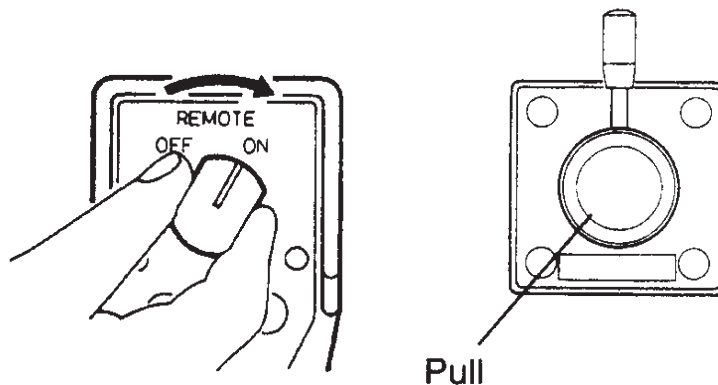

*How to power button-and lever-type remote controllers*

The indication "NFU RC" (Remote Controller) appears on the control unit.

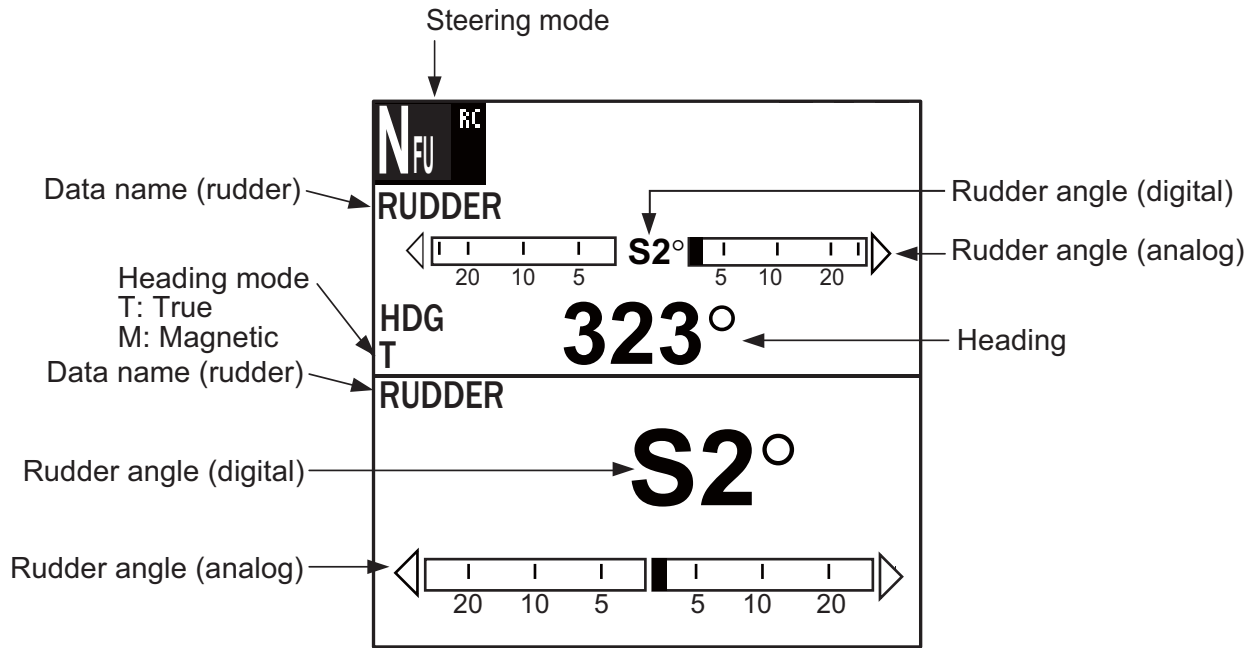

*Autopilot display in NFU mode (example: NAVpilot-700)*

- For button-and-dodge-type remote controllers, press the ◀ or ▶ key on the remote controller. For the lever-type, position the lever for the direction.

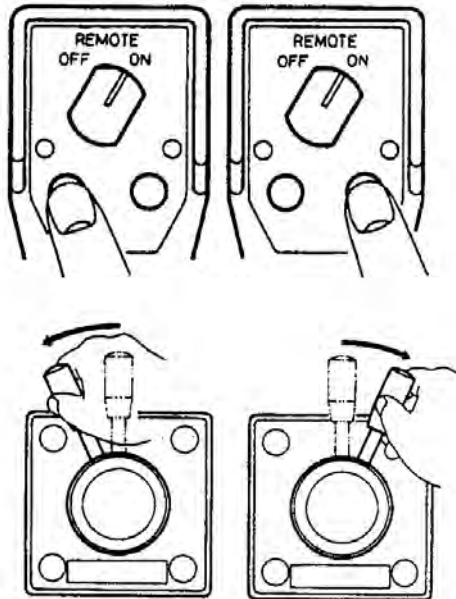

## 2. STEERING MODES

- For the button-and lever-type remote controllers, turn off the remote controller to terminate the REMOTE mode. For the dodge-type remote controller, simply release a key. Control is returned to the control unit and the previously used mode (STBY, AUTO or NAV).

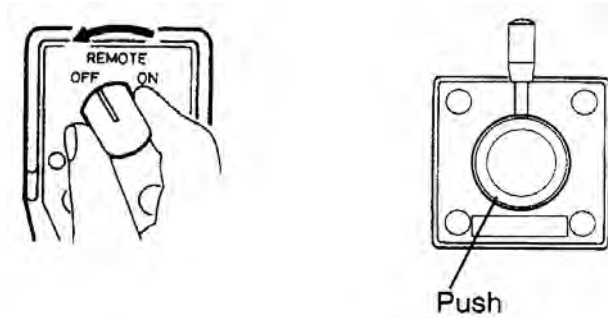

*How to power off button-and lever-type remote controllers*

## 2.9 DODGE Mode

The DODGE mode is useful in situations where you need to quickly take control of the helm to avoid an obstruction.

To quit the DODGE mode, release the ◀ or ▶ key.

### 2.9.1 How to dodge in the AUTO and NAV modes

Press the ◀ or ▶ key down to steer appropriately until the boat has cleared the obstruction. The equipment goes into the DODGE mode and the audible alarm sounds when one of the above keys is operated, to alert you to dodge operation. Note also that "DODG" appears on the display.

**Note:** In the AUTO mode, the ◀ and ▶ keys can be used to change the course degree by 5° or 10° or user setting (1°-90°, one-degree steps) steps depending on the installation setting. It is useful when you need to affect a large course change rapidly. However, the DODGE mode becomes inoperative when this function is activated. For details, ask your serviceman.

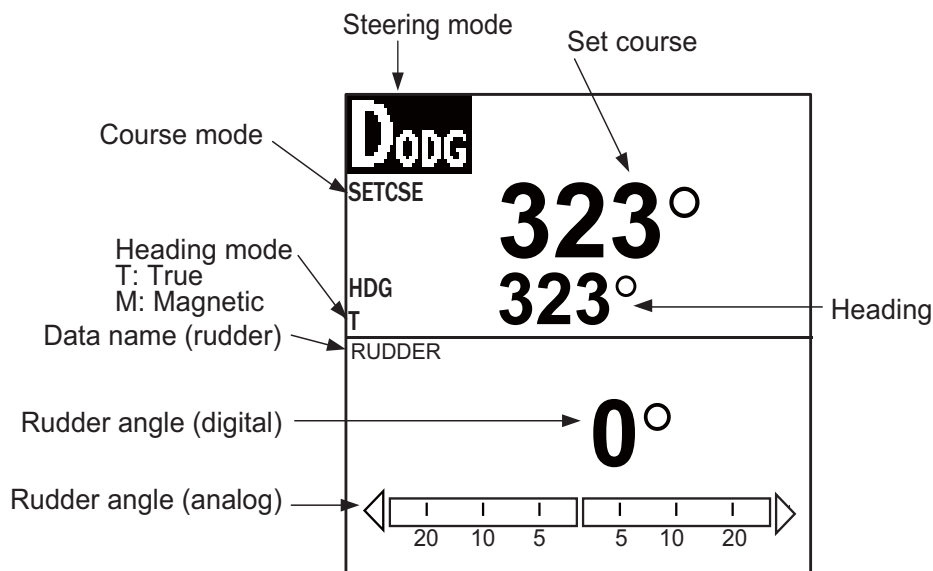

*Autopilot display (NAVpilot-700)*

## 2.9.2 How to FU dodge in the STBY mode

**Note:** FU dodge mode is not available with Fantum Feedback™.

Press the ◀ or ▶ key down to steer appropriately until the boat has cleared the obstruction. The equipment goes into the DODGE mode (from STBY to DODGE mode the mode indication shows "NFU"\* (Non-Follow Up) while pressing the ◀ or ▶ key. Steering can not be done from other control units or remote controllers. Further the audible alarm sounds when one of the above keys is operated, to alert you to dodge operation. The steering mode indication shows [DODG]. If the Course control knob is operated, the display shows "FU" and the rudder is moved until you stop operating the knob. To escape from the FU or NFU mode, press the **STBY** key.

## 2.9.3 How to NFU dodge in the STBY mode

Non-Follow up (NFU) is a manual steering mode that moves the rudder as long as the or ◀ or ▶ key is operated.

## 2.10 WIND Mode (for sailboats)

In the WIND mode, the NAVpilot steers the boat based on the wind angle. The NAVpilot consistently maintains the preset angle between ship's heading and wind direction (true or apparent), while eliminating the effects of turbulence and short term wind variations.

The WIND mode requires wind sensor data and the ship's characteristic (set on the menu at installation) must be set for "sailboat."

**Note:** The WIND mode is not available with Fantum Feedback™.

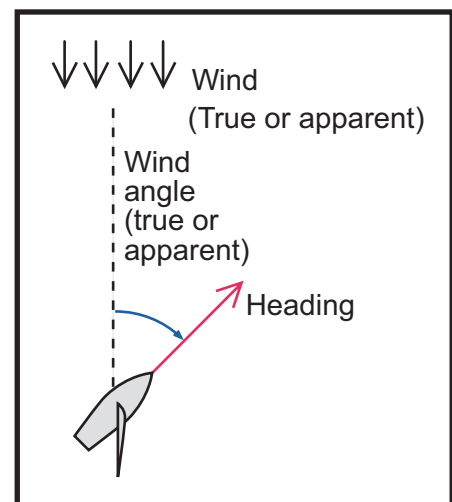

### 2.10.1 How to get the WIND mode

1. Direct the heading to the desired direction and trim the sail to keep the wind direction, in the STBY mode.
2. Press the **AUTO** key while holding the **STBY** key down to activate the WIND mode.
3. Set the wind angle by rotating the **Course control** knob.

## 2. STEERING MODES

- To escape from the WIND mode, press the **STBY** key.

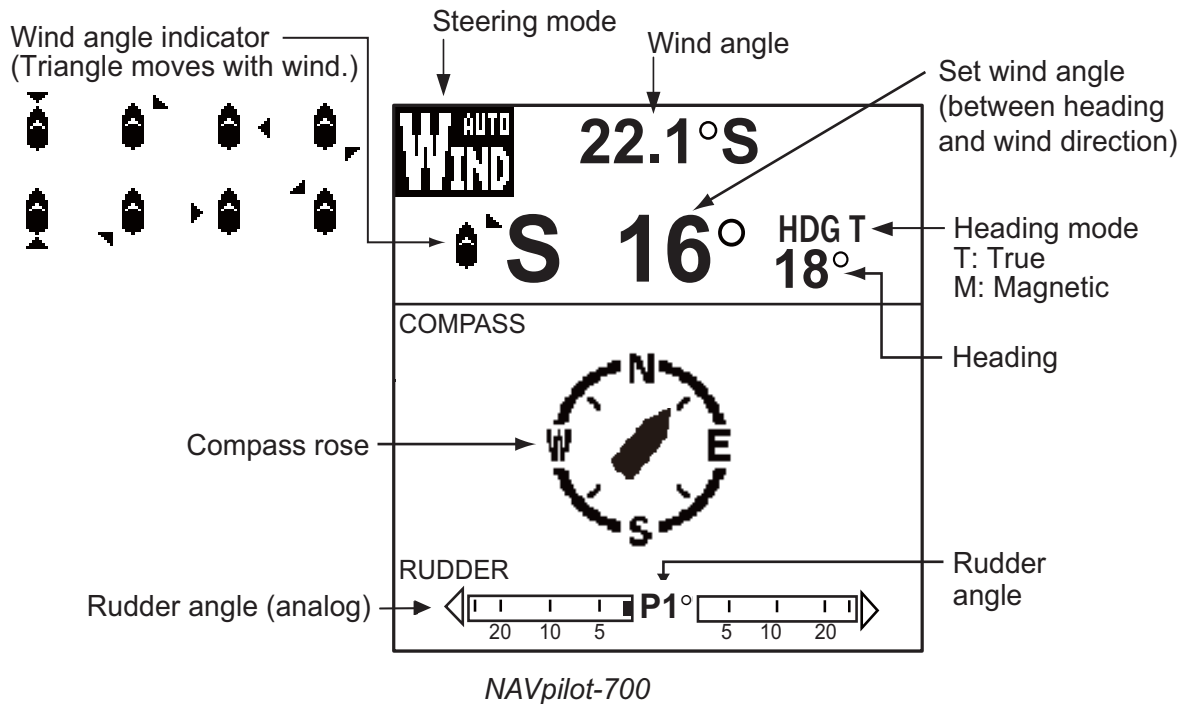

### 2.10.2 Wind angle mode

There are two wind angle modes: AWA (Apparent Wind Angle) and TWA (True Wind Angle).

**AWA:** The boat is steered so that the apparent wind angle is constant. AWA mode requires wind angle and speed data from a wind sensor. Use this mode when wind is stable.

**TWA:** The boat is steered so that the true wind angle (in relation to ship's bow) is constant. This mode requires apparent wind angle, apparent wind speed, your boat's speed and heading. Use this mode when there is an unstable downwind.

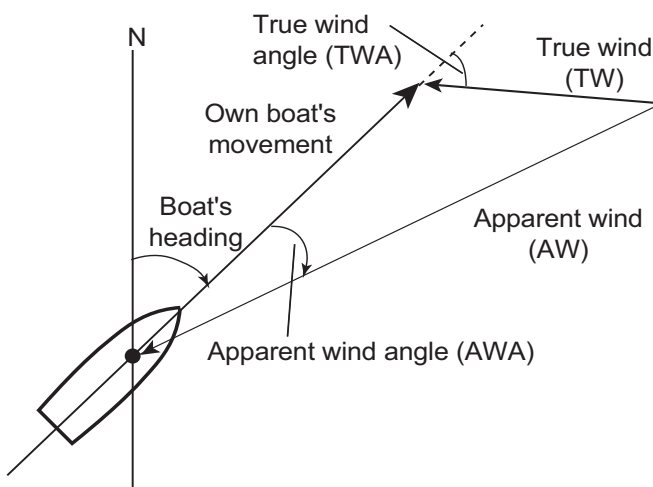

### NOTICE

**When running on engine, use the TWA mode.**

The autopilot cannot control your boat when its speed exceeds the true wind speed in AWA mode, which can lead to a potentially dangerous situation.

To select the wind angle mode, do the following:



1. Press the **MENU** key to open the menu.
2. Rotate the **Course control** knob to select [OTHER MENU] then push the **Course control** knob.
3. Rotate the **Course control** knob to select [WIND OPTION] then push the knob.
4. Rotate the **Course control** knob to select [MODE TYPE] then push the knob.
5. Rotate the **Course control** knob to select an option then push the knob.

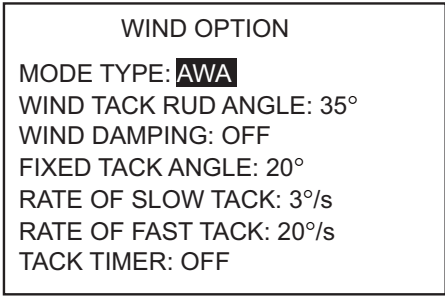

### 2.10.3 TACK mode

The TACK mode provides various tacking and gybing motions with the **TURN** key. Fixed and auto tacking are available.

#### Tacking/gybing (fixed tack)

This function changes the current course by the degrees (set on menu) to port or starboard direction. There are two types of speed, SLOW (for gybing) and FAST (for tacking) in this mode. Use the tack mode when the true wind angle is less than 90°.

To start tacking/gybing, do the following:

1. Press the **AUTO** key to get the AUTO mode.
2. Press the **TURN** key to show the Turn menu.

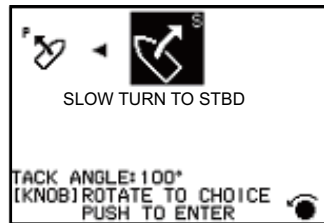

NAVpilot-700

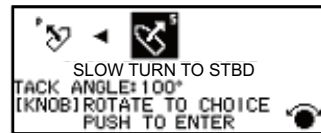

NAVpilot-711 NAVpilot-720

3. Rotate the **Course control** knob to select a turn.  
**SLOW TURN TO PORT** or **SLOW TURN TO STBD**: For gybing, when the wind angle is larger than 120°. The boat slowly changes the heading angle.

## 2. STEERING MODES

**FAST TURN TO PORT or FAST TURN TO STBD:** For tacking, when the true wind angle is less than 90°. The boat rapidly changes the heading angle.

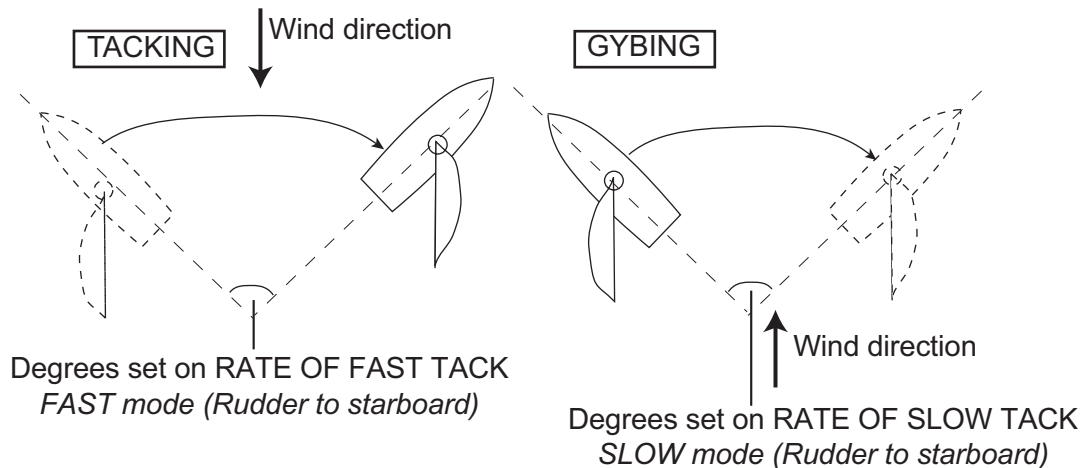

4. Push the **Course control** knob to start the turn.  
The steering mode indication shows [BEGINNING TURN]. When the turn starts, three beeps sound. You can set the timing between pressing the **Course control** knob and starting tacking. See "How to set the tack timer" on page 2-31.
5. While confirming your heading, do jib sheet creasing and trimming operations.  
Your boat starts turning in the direction selected at step 3
  - The tacking angle can be set on the menu. See "How to set the fixed tack angle" on the next page.
  - When the turning is completed, a beep sounds three times and the message "THE TURN ENDED" appears.

### **How to set the rate of turn for FAST and SLOW tacking**

The rate of turn is preset as 3° for SLOW and 20° for FAST. If you need to change the value, do the following:

1. Press the **MENU** key to open the menu.
2. Rotate the **Course control** knob to select [OTHER MENU] then push the **Course control** knob.
3. Rotate the **Course control** knob to select [WIND OPTION] then push the knob.
4. Rotate the **Course control** knob to select the value shown for [RATE OF SLOW TACK] then push the knob.
5. Rotate the **Course control** knob to set the rate then push the knob.
6. Rotate the **Course control** knob to select the value shown for [RATE OF FAST TACK] then push the knob.
7. Rotate the **Course control** knob to set the rate then push the knob.
8. Press the **MENU** key three times to close the menu.

**How to set the fixed tack angle**

The fixed tacking mode requires the setting of tacking angle. Set the angle as follows:

1. Press the **MENU** key to open the menu.
2. Rotate the **Course control** knob to select [OTHER MENU] then push the **Course control** knob.
3. Rotate the **Course control** knob to select [WIND OPTION] then push the knob.
4. Rotate the **Course control** knob to select the value shown for [FIXED TACK ANGLE] then push the knob.
5. Rotate the **Course control** knob to set the angle then push the knob.
6. Press the **MENU** key three times to close the menu.

**2.10.4 Tacking in WIND mode (WIND TACK)**

In the WIND mode, the degree and direction of tacking are automatically set so that the boat receives the apparent wind on its opposite side with the same angle.

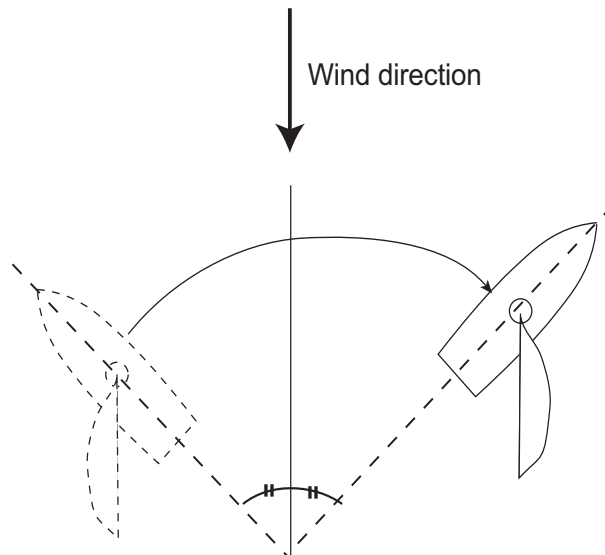

To start turning, do the following:

## 2. STEERING MODES

1. In the WIND mode, press the **TURN** key to show the Turn menu.  
The turning direction is determined according to the heading at the time the key is pressed, as shown below.

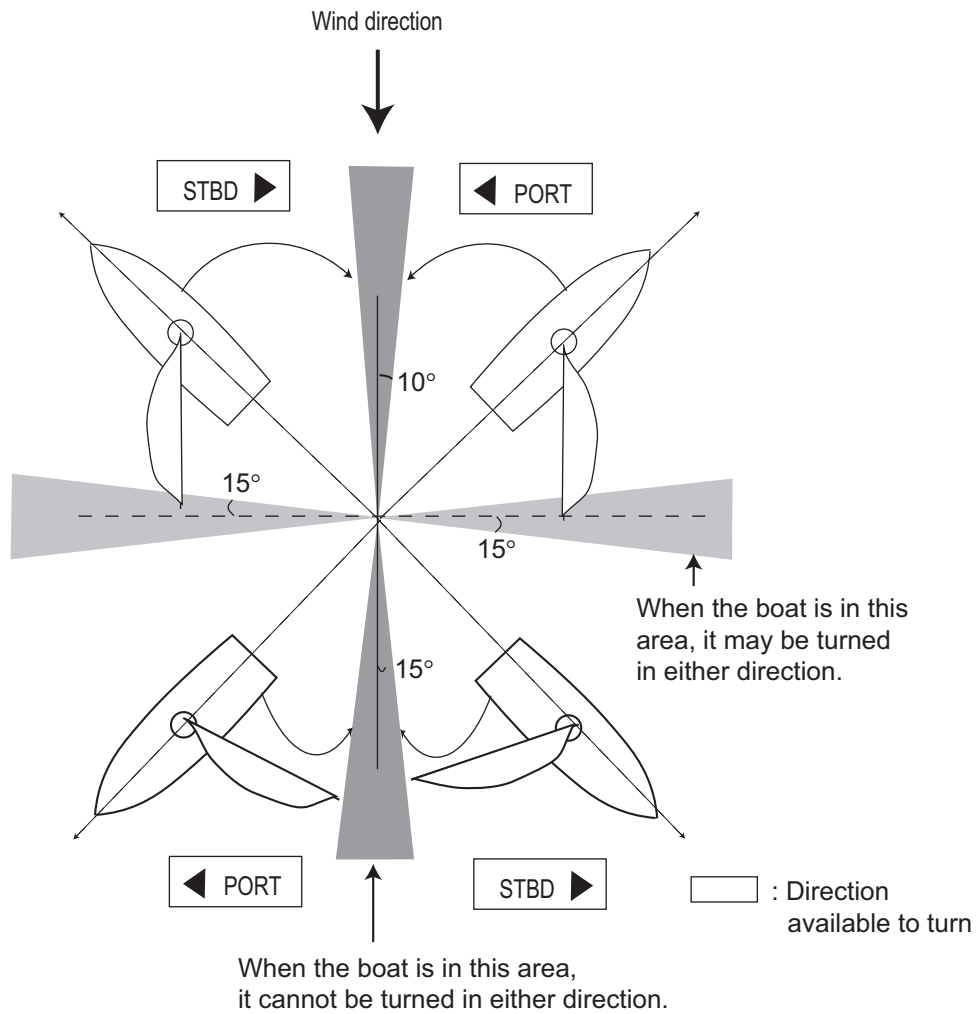

2. Rotate the **Course control** knob to select the direction to turn.  
The choices are "TURN TO PORT" and "TURN TO STBD" (starboard). If you select an unavailable direction, the message "WIND DIRECTION OUT OF RANGE FOR YOUR CHOICE." appears and the selection is refused.

3. Push the **Course control** knob to start the turn.  
The boat starts turning toward the selected direction until the heading changes twice that set when the **Course control** knob was pressed. When the **Course control** knob is pressed, for example, at the P (port) 50°, the boat turns until the heading decreases 100°.

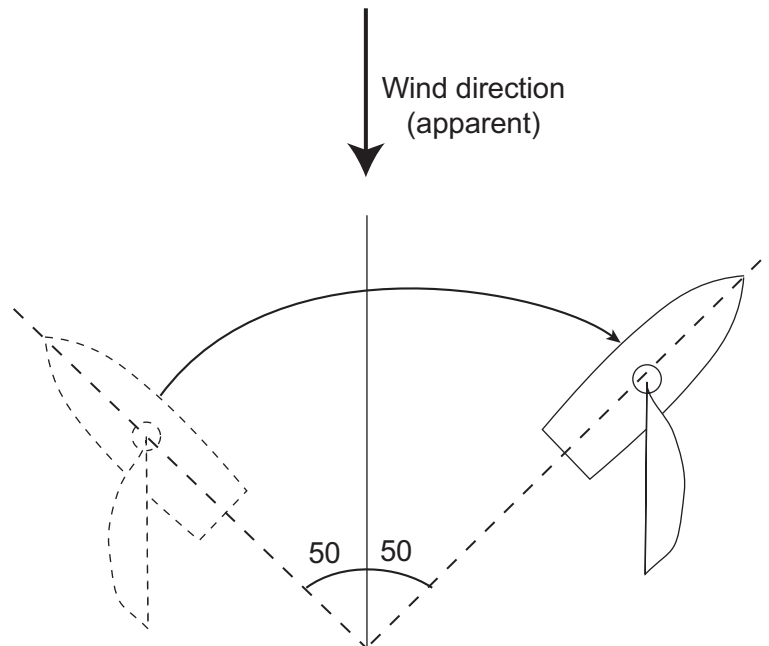

*Tacking maneuver when wind angle is 50°*

You can set the tacking start timing between pressing the **Course control** knob and the start of turning. For details, see “How to set the tack timer” on page 2-31.

4. When the turning is completed, a beep sounds three times.

#### **How to set maximum rudder angle for wind tacking**

The tacking in the WIND mode requires the setting of maximum rudder angle. This angle is calculated automatically when the NAVpilot is installed. If you need to change the value, do the following:

1. Press the **MENU** key to open the menu.
2. Rotate the **Course control** knob to select [OTHER MENU] then push the knob.
3. Rotate the **Course control** knob to select [WIND OPTION] then push the knob.
4. Rotate the **Course control** knob to select the value shown for [WIND TACK RUD ANGLE] then push the knob.
5. Rotate the **Course control** knob to set the angle then push the knob.
6. Press the **MENU** key to three times close the menu.

## 2. STEERING MODES

### How to set the damping interval for wind data

You can set the damping interval for wind data to compensate for random fluctuation in wind data. The higher the setting the more “smooth” the data. However, a high damping interval causes delay in receiving wind data; the amount of delay equivalent to the damping interval. Turn off wind damping if the wind data is received stably.

The port and starboard wind angles must be  $55^\circ$  or higher and the [MODE TYPE] must be selected to [AWA] to use this function.

1. Press the **MENU** key to open the menu.
2. Rotate the **Course control** knob to select the current setting for [WIND DAMPING] then push the knob.



3. Rotate the **Course control** knob to select [ON] then push the knob.
4. Rotate the **Course control** knob to select the current wind damping interval then push the knob.
5. Rotate the **Course control** knob to set the interval then push the knob. The setting range is 0.7 to 99 (sec.). See the table below for wind angle and wind damping interval.

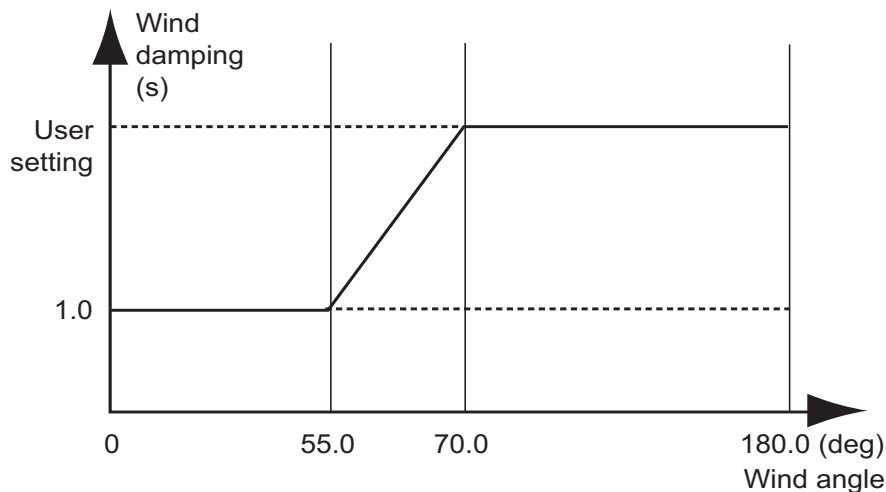

6. Press the **MENU** key to close the menu.

### How to set the tack timer

You can set the amount of time to wait before starting a turn, after pushing the **Course control** knob.

1. Press the **MENU** key to open the menu.
2. Rotate the **Course control** knob to select [OTHER MENU] then push the knob.
3. Rotate the **Course control** knob to select [WIND OPTION] then push the knob.
4. Rotate the **Course control** knob to select the value shown for [TACK TIMER] then push the knob to show the tack timer options.



5. Rotate the **Course control** knob to select [ON] then push the knob.
6. Rotate the **Course control** knob to select the current timer value then push the knob.
7. Rotate the **Course control** knob to set the timer value then push the knob. The setting range is 1-99 (sec.).
8. Press the **MENU** key three times to close the menu.

## 2.11 Safe Helm Mode

The safe helm mode, available with the Accu-Steer FPS 12V/24V drive unit, temporarily switches the NAVpilot to manual steering for the specified time interval when the helm is steered in an automatic steering mode (AUTO, NAV, etc.). After cruising at angular velocity  $3^\circ$  or less per second for the set time, the safe helm mode is deactivated and the previous automatic steering mode is restored. This prevents continued turning of the helm. The mode and course indications flash when the safe helm mode activates.

**Note:** The safe helm mode is not available with Fantum Feedback™.

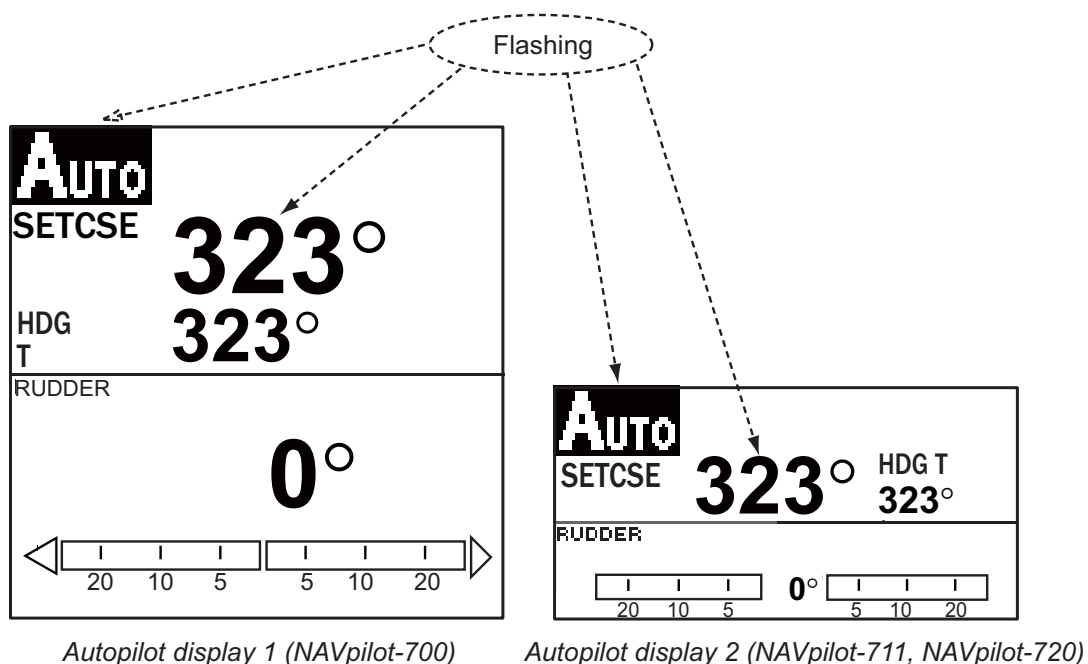

## 2. STEERING MODES

### How to set the safe helm mode

1. Open the menu in the STBY mode.
2. Use the **Course control** knob to select the [OTHER] menu then select [SAFE HELM/P.ASSIST SETUP].

SAFE HELM/P.ASSIST SETUP
SAFE HELM: <b>ON</b>
RETURN DELAY 5 SEC
SAFE HELM RESPONSE
POWER ASSIST: OFF

3. Use the **Course control** knob to select [SAFE HELM] then push the knob.
4. Use the **Course control** knob to select [ON] then push the knob.
5. Use the **Course control** knob to select [RETURN DELAY] then push the knob.
6. Rotate the **Course control** knob to set the return delay.  
After cruising at angular velocity 3° or less per second for the set time, the safe helm mode is deactivated and the AUTO or NAV mode is restored. The setting range is 1-20 seconds.
7. Use the **Course control** knob to select [SAFE HELM RESPONSE] then push the knob.

SAFE HELM RESPONSE
RESPONSE: <b>6</b> PORT STBD
TURN HELM PORT/STBD TO SET SAFE HELM RESPONSE TIME. HIGHER VALUE = FASTER RESPONSE
PUSH MENU KEY TO CONTINUE

8. Turn the **Course control** knob to set the response then push the knob. Turn the helm to port or starboard. A beep sounds and the indication PORT or STBD on the menu appear in reverse video.
9. Press the **MENU** key to finish.



## 2.12 Power Assist Mode

The power assist mode, available with the Accu-Steer FPS 12V/24V type drive, customizes manual steering to your own preferences. The mode is available during the safe helm mode and the STBY mode. The indication “PA” appears at top of the screen when the mode is active.

**Note:** The power assist mode is not available with Fantum Feedback™.

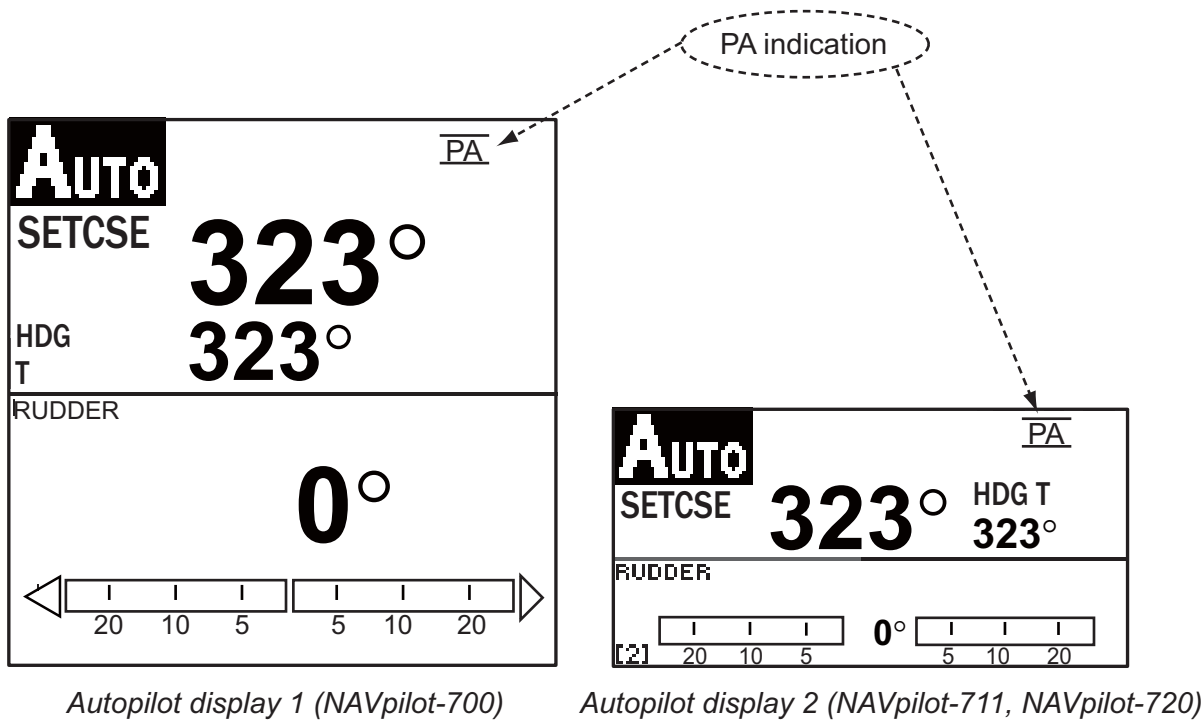

### How to set the power assist mode

1. Open the menu in the STBY mode.
2. Use the **Course control** knob to select the [OTHER] menu then select [SAFE HELM/P.ASSIST SETUP].

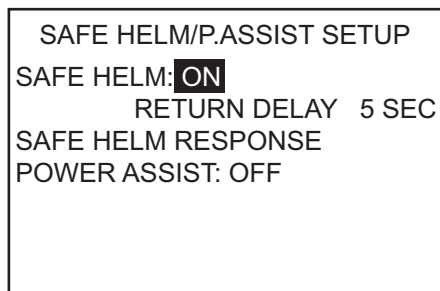

3. Use the **Course control** knob to select [POWER ASSIST] then push the knob.

## 2. STEERING MODES

4. Use the **Course control** knob to select [ON] then push the knob.  
When this is done the menu items for power assist appear.

SAFE HELM/P.ASSIST SETUP
SAFE HELM: <b>ON</b>
RETURN DELAY 5 SEC
SAFE HELM RESPONSE
POWER ASSIST: OFF
FOR SPEEDS UNDER 3.0kn
POWER ASSIST STBY: ON
POWER ASSIST RUDDER SPEED

5. Use the **Course control** knob to select [FOR SPEEDS UNDER] then push the knob.
6. Rotate the **Course control** knob to set the highest speed at which power assist activates. The setting range is 1.0 to 9.9 knots.
7. **If you want power assist in the STBY mode**, use the **Course control** knob to set [POWER ASSIST STBY] to [ON].
8. Use the **Course control** knob to select [POWER ASSIST RUDDER SPEED] then push the knob.

POWER ASSIST RUDDER SPEED
RUDDER SPEED: <b>10</b>
TURN HELM PORT/STBD TO SET RUDDER SPEED. HIGHER VALUE = FASTER SPEED PUSH MENU KEY TO CONTINUE

9. Turn the helm to port and starboard to set safe helm response time then push the **Course Control** knob.
10. Press the **MENU** key to finish.

# 3. ALARMS

---

Your NAVpilot has nine conditions which generate both audio and visual alarms: watch alarm, deviation alarm, XTE (cross-track error) alarm, wind alarm (four types, sailboats only), arrival alarm, speed alarm, depth alarm, water temperature alarm, and log trip alarm.

When an alarm is violated, the buzzer sounds, and the alarm icon (🚨) and a pop-up message display appear (see section 5.5.3). You can see which alarm(s) has been violated by opening the Alarm Log, from the [SYSTEM SETUP] menu.

## 3.1 ALARM Menu

All alarm operations are done from the [ALARM] menu. To show the [ALARM] menu, do as follows:

1. Press the **MENU** key to open the menu.
2. Rotate the **Course control** knob to select [OTHER MENU] then push the knob.
3. Rotate the **Course control** knob to select [ALARM] then push the knob.

Page 1

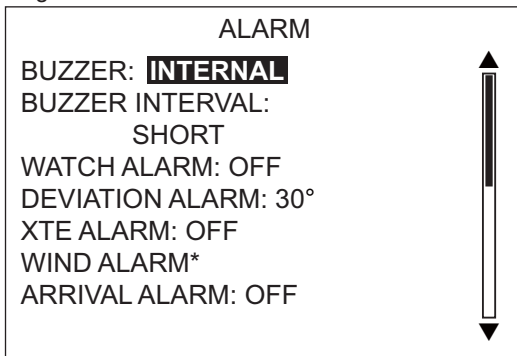

Page 2

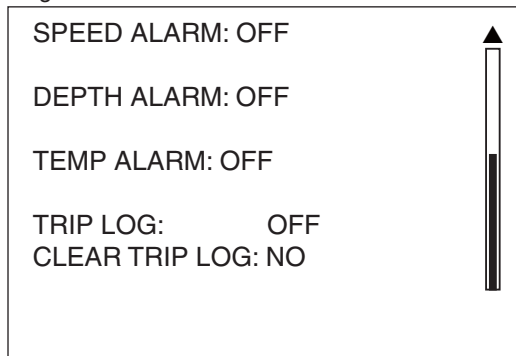

\* Appears when Ship's Characteristics is set for "Sailboat".

## 3.2 Alarm Buzzer

You can select the buzzer from which to output the audio alarm as follows. Use the external buzzer if the volume of the internal buzzer is not loud enough.

1. Rotate the **Course control** knob to select [BUZZER] from the ALARM menu then push the knob.
2. Rotate the **Course control** knob to select [INTERNAL] or [INTERNAL+EXTERNAL] then push the knob.  
 [INTERNAL]: Buzzer in Control Unit sounds.  
 [INTERNAL+EXTERNAL]: Buzzer in control unit and external buzzer sound.
3. Push the **Course control** knob to confirm setting.



## 3.3 Buzzer Interval

The sound pattern for the alarms can be selected as follows.

1. Rotate the **Course control** knob to select [BUZZER INTERVAL] from the [ALARM] menu then push the knob.



2. Rotate the **Course control** knob to select [SHORT], [LONG] or [CONTINUOUS] then push the knob. [CONTINUOUS] releases the buzzer continuously.



3. Push the **Course control** knob to confirm setting.

## 3.4 Watch Alarm

The watch alarm periodically warns the helmsman to check the NAVpilot when in the AUTO or NAV mode.

1. Rotate the **Course control** knob to select [WATCH ALARM] from the [ALARM] menu then push the knob.



2. Rotate the **Course control** knob to select [OFF] or [ON] then push the knob. For [OFF] got to step 5.
3. Rotate the **Course control** knob to select the current watch alarm value then push the knob.
4. Rotate the **Course control** knob to set the time interval (1 to 99 min).
5. Push the **Course control** knob to confirm setting.

If the set time passes without operation, the buzzer sounds and the message "THE SET TIME HAS PASSED" appears. Further, if three minutes elapses after the watch alarm has sounded, the alarm becomes louder. Press any key to clear the alarm.

## 3.5 Deviation Alarm

The deviation alarm sounds in the AUTO and NAV modes when the heading deviates more than the deviation alarm value.

1. Rotate the **Course control** knob to select the current setting for [DEVIATION ALARM] from the [ALARM] menu then push the knob.
2. Rotate the **Course control** knob to set the degree of deviation then push the knob.

## 3.6 XTE Alarm

The XTE alarm, which is available in the NAV mode, alerts you when the course error has exceeded the XTE alarm setting.

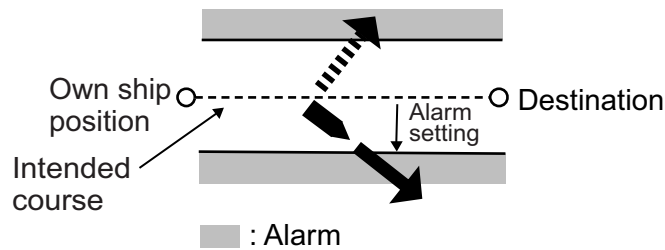

1. Rotate the **Course control** knob to select [XTE ALARM] from the [ALARM] menu then push the knob.



2. Rotate the **Course control** knob to select [OFF] or [ON] then push the knob. For [OFF], press the **MENU** key consecutively to close the menu.
3. Rotate the **Course control** knob to select the current XTE alarm value then push the knob.
4. Rotate the **Course control** knob to set the XTE alarm value.
5. Push the **Course control** knob to confirm setting.

## 3.7 Arrival Alarm

The arrival alarm alerts you when you are within a specific distance from a waypoint.

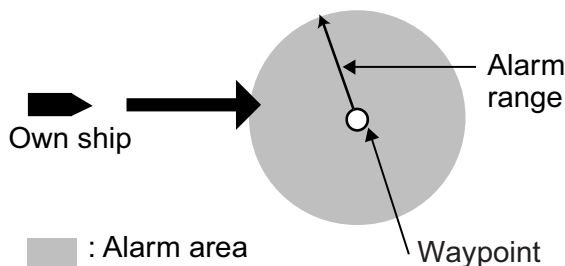

1. Rotate the **Course control** knob to select [ARRIVAL ALARM] from the [ALARM] menu then push the knob.



2. Rotate the **Course control** knob to select [OFF] or [ON] then push the knob. For [OFF], press the **MENU** key consecutively to close the menu.
3. Rotate the **Course control** knob to select the current arrival alarm value then push the knob.
4. Rotate the **Course control** knob to set the arrival alarm value.
5. Push the **Course control** knob to confirm setting.

## 3.8 Speed Alarm

The speed alarm warns you when the speed of your boat is within, outside, over or under the speed range setting. Requires speed data.

1. Rotate the **Course control** knob to select [SPEED ALARM] from the [ALARM] menu then push the knob.

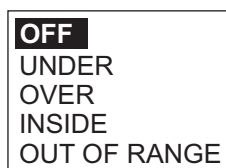

2. Rotate the **Course control** knob to select an option then push the knob. For [OFF], press the **MENU** key consecutively to close the menu.  
 [OFF]: Turn the alarm off.  
 [UNDER]: Alarm sounds when ship's speed is under the set value.  
 [OVER]: Alarm sounds when ship's speed is over the set value.  
 [INSIDE]: Alarm sounds when ship's speed is within the speed range set.  
 [OUT OF RANGE]: Alarm sounds when ship's speed is outside the range set.
3. Rotate the **Course control** knob to set value.  
 For [INSIDE] and [OUT OF RANGE], set the upper and lower limits for the alarm.  
 For [OVER] and [UNDER], set a value.
4. Push the **Course control** knob to confirm setting.

## 3.9 Depth Alarm

The depth alarm warns you when the bottom is shallower, deeper within or outside the depth alarm setting. Requires a depth sensor.

1. Rotate the **Course control** knob to select [DEPTH ALARM] from the [ALARM] menu then push the knob.

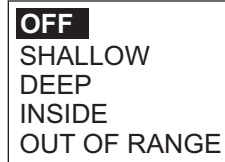

2. Rotate the **Course control** knob to select an option then push the knob. For [OFF], press the **MENU** key consecutively to close the menu.  
 [OFF]: Turn the alarm off.  
 [SHALLOW]: Alarm sounds when depth is less than the set value.  
 [DEEP]: Alarm sounds when depth is greater than the set value.  
 [INSIDE]: Alarm sounds when depth is within the depth range set.  
 [OUT OF RANGE]: Alarm sounds when depth is outside the range set.
3. Rotate the **Course control** knob to set value.  
 For [INSIDE] and [OUT OF RANGE], set the upper and lower limits for the alarm.  
 For [SHALLOW] and [DEEP], set a value.
4. Push the **Course control** knob to confirm setting.

## 3.10 Water Temperature Alarm

There are five types of water temperature alarms: [UNDER], [OVER], [INSIDE], [OUT OF RANGE] and [SHEAR]. Requires a water temperature sensor.

1. Rotate the **Course control** knob to select [TEMP ALARM] from the [ALARM] menu then push the knob.
2. Rotate the **Course control** knob to select an option then push the knob. For [OFF], press the **MENU** key consecutively to close the menu.  
 [OFF]: Turn the alarm off.  
 [UNDER]: Alarm sounds when water temperature is less than the set value.  
 [OVER]: Alarm sounds when water temperature is higher than the set value.  
 [INSIDE]: Alarm sounds when water temperature is within the depth range set.  
 [OUT OF RANGE]: Alarm sounds when water temperature is outside the range set.  
 [SHEAR]: Alarm sounds when the temperature changes over the value set within a minute.
3. Rotate the **Course control** knob to set value.  
 [INSIDE], [OUT OF RANGE]: Set the upper and lower limits for the alarm.  
 [OVER], [UNDER], [SHEAR]: Set a value.
4. Push the **Course control** knob to confirm setting.

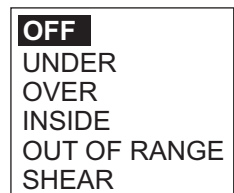



## 3.11 Trip Distance Alarm, Trip Distance Reset

### 3.11.1 How to set the log trip alarm

The log trip alarm alerts when you have traveled a specific distance.

1. Rotate the **Course control** knob to select [TRIP LOG] from the [ALARM] menu then push the knob.



2. Rotate the **Course control** knob to select [OFF] or [ON] then push the knob. For [OFF], press the **MENU** key consecutively to close the menu.
3. Rotate the **Course control** knob to set a value.
4. Push the **Course control** knob to confirm setting.

### 3.11.2 How to reset the trip distance

Follow the procedure below to reset the trip distance to zero.

1. Rotate the **Course control** knob to select [CLEAR TRIP LOG] from the [ALARM] menu then push the knob.



2. Rotate the **Course control** knob to select [YES] then push the knob.
3. Push the **Course control** knob reset the trip distance to zero.

## 3.12 Wind Alarms (for sailboats)

The WIND alarm, which is an alarm exclusively for sailboats, has four conditions which generate both audio and visual alarms: heading change, wind deviation, true wind speed and apparent wind speed.

To access the [WIND ALARM] menu, do the following:

1. Press the **MENU** key to open the menu.
2. Rotate the **Course control** knob to select [OTHER MENU] then push the knob.
3. Rotate the **Course control** knob to select [ALARM] then push the knob.
4. Rotate the **Course control** knob to select [WIND ALARM] then push the knob.

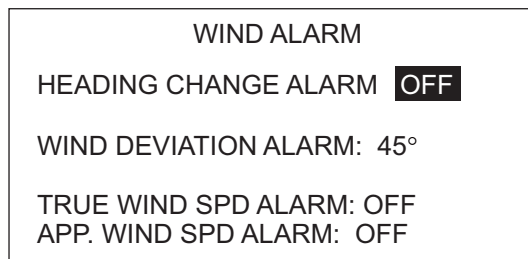

### 3.12.1 Heading change alarm

The heading change alarm sounds when own boat's heading changes remarkably by the effects of true wind angle. Set the heading value and alarm range as shown in the procedure which follows.

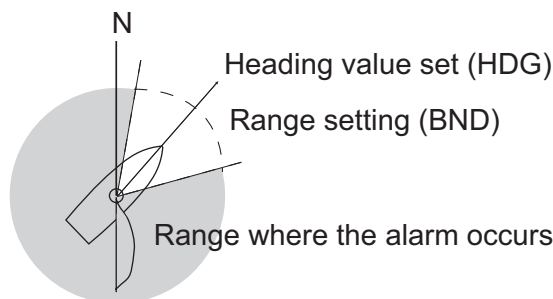

1. Rotate the **Course control** knob to select [HEADING CHANGE ALARM] from the [WIND ALARM] menu then push the knob.



2. Rotate the **Course control** knob to select [ON] then push the knob. The line below [HEADING CHANGE ALARM] shows two values.
3. Rotate the **Course control** knob to select the value (heading) at the far left then push the knob.
4. Rotate the **Course control** knob to set value then push the knob to confirm setting.
5. Rotate the **Course control** knob to select [BND] and then push the knob.
6. Rotate the **Course control** knob to set value then push the knob to confirm setting.

### 3.12.2 Wind deviation alarm

The wind deviation alarm sounds when the current wind angle is greater than the wind angle limit set.

1. Rotate the **Course control** knob to select the value for [WIND DEVIATION ALARM] from the [WIND ALARM] menu then push the knob.
2. Rotate the **Course control** knob to set value then push the knob to confirm setting.

### 3.12.3 True wind speed alarm

The true wind speed alarm warns you when the true wind speed is over or under the true wind speed alarm setting.

1. Rotate the **Course control** knob to select [TRUE WIND SPD ALARM] from the [WIND ALARM] menu then push the knob.



2. Rotate the **Course control** knob to select [ON] then push the knob.
3. Rotate the **Course control** knob to select the current true wind speed alarm value then push the knob.
4. Rotate the **Course control** knob to set the upper and lower limits for the alarm then push the knob to confirm setting.

### 3.12.4 Apparent wind speed alarm

The apparent wind speed alarm warns you when the apparent wind speed is over or under the apparent wind speed alarm setting.

1. Rotate the **Course control** knob to select [APP. WIND SPD ALARM] from the [WIND ALARM] menu then push the knob.



2. Rotate the **Course control** knob to select [ON] then push the knob.
3. Rotate the **Course control** knob to select the current apparent wind speed alarm value then push the knob.
4. Rotate the **Course control** knob to set the upper and lower limits for the alarm then push the knob to confirm setting.

### 3.13 Alarm Log

The Alarm Log shows the date, time and alarm no. of violated alarms. To show this log, select [ALARM LOG] from the [SYSTEM SETUP] menu. For a list of alarm numbers, see section 5.5.3.

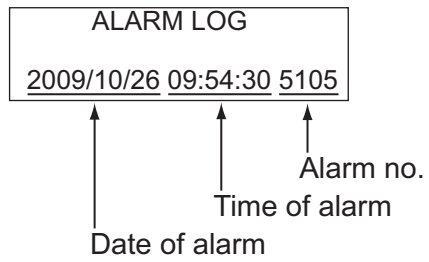

# 4. HOW TO CUSTOMIZE YOUR NAVPILOT

---

This chapter shows you how to customize your NAVpilot to suit the characteristics of your boat and your operational needs.

The items shown in each menu depend on the mode in use. For the STBY mode the complete menu is shown. In the AUTO, NAV or WIND mode, only the menu items related to those modes are shown.

In the STBY mode, press the **MENU** key to show the STBY mode menu.

*NAVpilot-700*

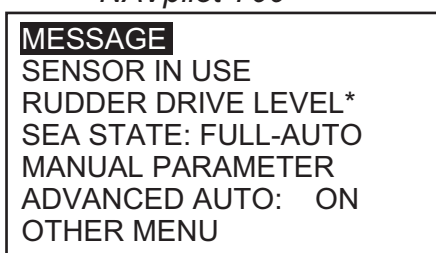

*NAVpilot-711/720*

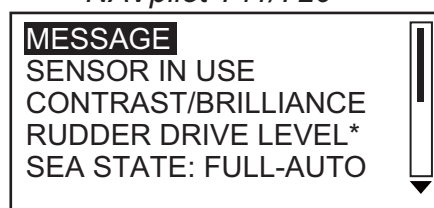

\* Shown with Fantum Feedback™.

## 4.1 Parameter Setup (PARAMETER SETUP Menu)

The various parameters for your NAVpilot are set up from the [PARAMETER SETUP] menu, which is in the [OTHER MENU].

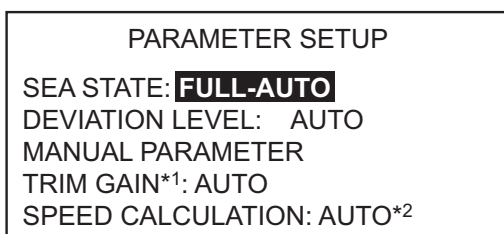

*NAVpilot-700*

\*1 Not shown with Fantum Feedback™.

\*2 Appears on page 2 of menu for NAVpilot-711/720.

### 4.1.1 Sea state

Your NAVpilot has an automatic adjustment feature which sets up the equipment according to ship's characteristics and sea state, for optimum performance in the AUTO, NAV and WIND modes. In addition, a self-learning algorithm is incorporated: Parameters for rudder ratio, counter rudder and auto trim gains are constantly optimized based on the steering history of your boat, and are stored in memory for future navigation.

#### How to select NAVpilot steering parameters

Set how the NAVpilot steers your boat as follows:

1. Rotate the **Course control** knob to select [SEA STATE] then push the knob.



2. Rotate the **Course control** knob to select the option which best matches current sea state then push the knob. For items other than [FULL-AUTO], go to step 4.  
[FULL-AUTO]: Auto adjustment and self-learning are on.  
[SEMI-AUTO]: Auto adjustment is on, self-learning is off.  
[MANUAL-CALM]: Self-learning is off, using the parameter selected for calm sea.  
[MANUAL-MODERATE]: Self-learning is off, using the parameters for a typical normal sea state.  
[MANUAL-ROUGH]: Self-learning is off, using preset parameters for a typical rough sea state.

For normal, everyday operation, the [FULL-AUTO] mode is recommended. However, if you want the NAVpilot to steer the boat based on experience-related parameters, but you don't want the pilot to be in "self-learning" mode, choose the [SEMI-AUTO] option. Note that the course keeping quality may be decreased if the sea state is different from the experience-related parameters. This option is provided if you happen to be using the pilot in a situation that you do not anticipate encountering again.

3. For [FULL-AUTO], set the deviation level as follows:
  - 1) Rotate the **Course control** knob to select [DEVIATION LEVEL] then push the knob.



- 2) Rotate the **Course control** knob to select [AUTO] or [LEVEL]. For [LEVEL], you may set a value between 1 and 9. A lower number keeps the course more precisely but the rudder may be turned more often. With a higher number, the rudder is fixed, but the course may not be kept as precisely.
4. Push the **Course control** knob to confirm setting.

### How to manually set NAVpilot steering parameters

When [MANUAL-CALM], [MANUAL-MODERATE] or [MANUAL-ROUGH] is selected as the sea state, set [MANUAL PARAMETER] as below.

You can set three parameters for the MANUAL function: Weather, Rudder gain and Counter rudder.

1. Rotate the **Course control** knob to select [MANUAL PARAMETER] from the [PARAMETER SETUP] menu then push the knob. The display now looks like the one shown below.

	[CALM]	[MODERATE]	[ROUGH]
[WEATHER]	1°	2°	3°
[RUDDER GAIN]	3	5	10
[COUNTER RUDDER]	1	2	4

2. Rotate the **Course control** knob to select the setting of [WEATHER-CALM] then press the knob.
3. Rotate the **Course control** knob to set value (0° to 10° for weather).
4. Push the **Course control** knob.
5. Set [WEATHER-MODERATE], [WEATHER-ROUGH] and [RUDDER GAIN] and [COUNTER RUDDER] similarly (setting range: 0-10 for weather, 1-20 for rudder gain, and 0-20 for counter rudder).
6. Press the **MENU** key to finish.

#### Guidelines for how to set SEA STATE

**[WEATHER]:** When the sea is rough, the boat's heading fluctuates to port and starboard. If the rudder is driven very often to maintain the set course, the helm mechanism may wear out. To prevent this, the weather adjustment makes the NAVpilot insensitive to minute course deviations. You may choose a degree between 1° to 10°. Until the course deviation exceeds the selected setting, steering to correct the heading will not be initiated.

The illustration at the top of the next page shows boat's track lines with weather setting 3° and 7°. When 7° is set, for example, the rudder is not driven until the course deviation exceeds 7°. Increasing the setting reduces activation of the steering gear, however the boat tends to zigzag. When the sea is calm, set a smaller value.

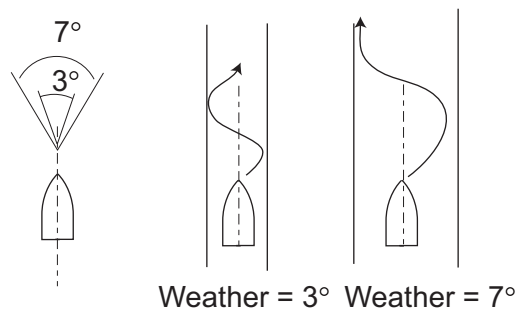

**[RUDDER GAIN]:** When the boat's heading deviates from the set course, the NAVpilot adjusts the rudder to correct it. The rudder angle (number of degrees) which is steered against every degree of course deviation is known as the rudder gain.

#### 4. HOW TO CUSTOMIZE YOUR NAVPILOT

The following illustrations show how many degrees the NAVpilot steers the rudder in order to nullify 4 degrees of course deviation with various settings of the rudder gain.

Rudder gain = 1°



Rudder angle = 4° x 1=4°

Rudder gain = 2°



Rudder angle = 4° x 2=8°

Rudder gain = 3°



Rudder angle = 4° x 3=12°

Set rudder gain so that the boat does not make frequent yaw. The figure shown below provides general guidelines for setting rudder gain.

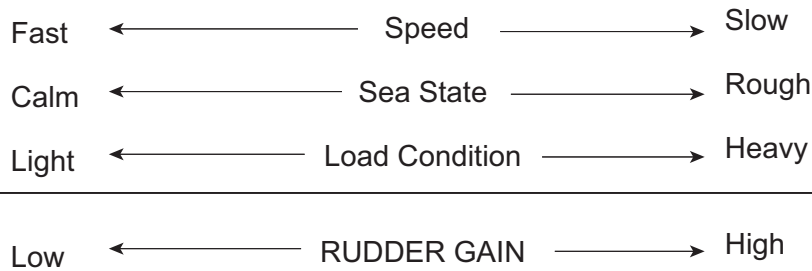

**[COUNTER RUDDER]:** If the boat is heavily loaded, the heading could change excessively because of inertia. This phenomenon causes the vessel to "overshoot" the intended course. If this happens, the NAVpilot will steer the rudder to the opposite side and the heading will turn in opposite direction excessively again. In an extreme case the heading oscillates several times until it finally settles in the new course. An adjustment known as "counter rudder" prevents this kind of oscillation.

Counter rudder is usually not required for small boats. When your boat zigzags a lot before settling in the new course, increase the counter rudder setting.



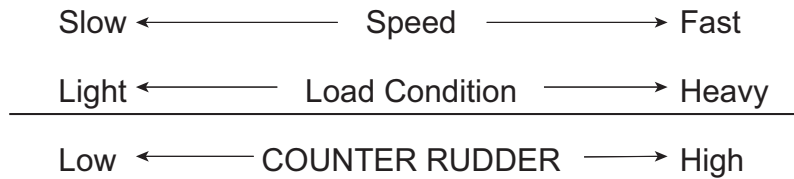
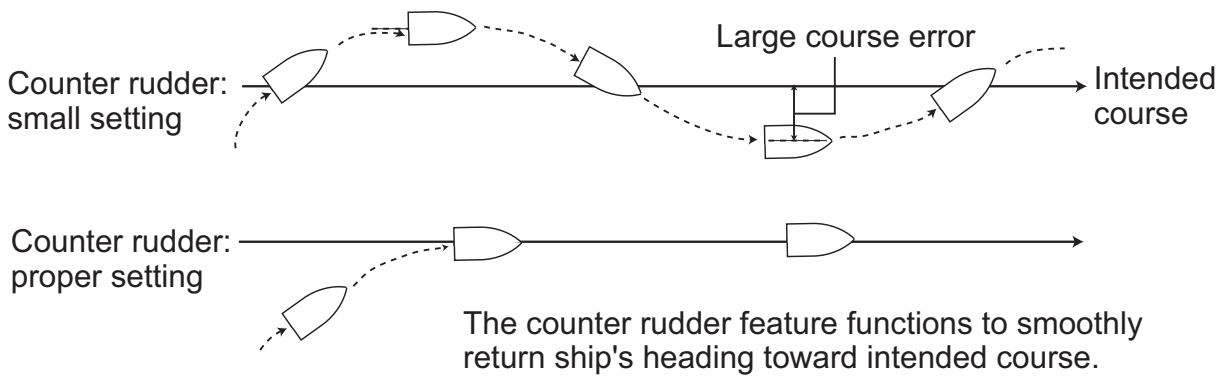

### 4.1.2 Trim gain

The NAVpilot continually monitors the boat's trim in order to keep the trim sensitivity optimum. A lower setting is common because boat's trim usually does not change quickly. A large number changes the trim compensation value more frequently. Too high of a setting may result in the following problems.

**Note:** Trim gain is not available with Fantum Feedback™.

- Trim sensitivity is over-affected, resulting that a trim appears in both port and starboard directions alternately.
- Trim compensation mechanism responds to the yawing, resulting in more serious oscillation of ship's heading.

To automatically set the trim, do as follows:

1. Rotate the **Course control** knob to select [TRIM GAIN] from the [PARAMETER SETUP] menu.
2. Push the **Course control** knob to show the options for [TRIM GAIN].
3. Rotate the **Course control** knob to select [AUTO] or [MANUAL] then push the knob. For [AUTO] go to step 6.
4. Rotate the **Course control** knob to select the current value and push the knob.
5. Rotate the **Course control** knob to set a value (1 to 20. The default value is automatically calculated according to length of your boat, entered on the [SHIP'S CHARACTERISTICS] menu at installation.
6. Push the **Course control** knob to finish.



### 4.1.3 Speed calculation

Speed is normally entered automatically, from your navigator. If the navigator fails, manually enter speed.

1. Rotate the **Course control** knob to select [SPEED CALCULATION] from the [PARAMETER SETUP] menu.
2. Push the **Course control** knob to show the options for [SPEED CALCULATION].



3. Rotate the **Course control** knob to select [AUTO] or [MANUAL] then push the knob. For [AUTO] go to step 4. For [MANUAL], do as follows:
  - 1) Rotate the **Course control** knob to select the current value then push the knob.
  - 2) Rotate the **Course control** knob to set a value (0.1 - 99.0).
4. Push the **Course control** knob to finish.

## 4.2 Rudder Drive Level (For Fantum Feedback™)

For Fantum Feedback™, the driving power of steering can be adjusted by the rudder drive level. The higher the setting is, the greater the rudder is turned.

1. Press the **MENU** key.
2. Rotate the **Course control** knob to select [RUDDER DRIVE LEVEL] then push the knob.
3. Rotate the **Course control** knob to set a value (1 - 20) then push the knob.
4. Press the **MENU** key to finish.

## 4.3 Net Towing

When a boat is towing fishing gear its stern is "dragged" by the net. This causes the boat to stray from its intended course. To keep the boat on course, you need to adjust the trim manually, which can be bothersome. If you do not want to be bothered with trim adjustments, you can enable the automatic towing function to have the trim automatically adjusted. This feature is useful for trawlers and purse seiners.

[SHIP'S CHARACTERISTICS] must be set for "other than sailboat" to get this feature.

**Note:** This feature is not available with Fantum Feedback™.

1. Open the [OTHER MENU] followed by the [AUTO OPTION] menu.
2. Rotate the **Course control** knob to select [NET TOWING AUTO] then push the knob.



3. Rotate the **Course control** knob to select [OFF] or [ON].
4. Push the **Course control** knob to finish.

Note that you must keep the boat on a straight course before the AUTO mode is selected.

## 4.4 Course After Operation of a Remote Controller

Select the course to follow after a remote controller is operated.

**Note:** This feature is not available with Fantum Feedback™.

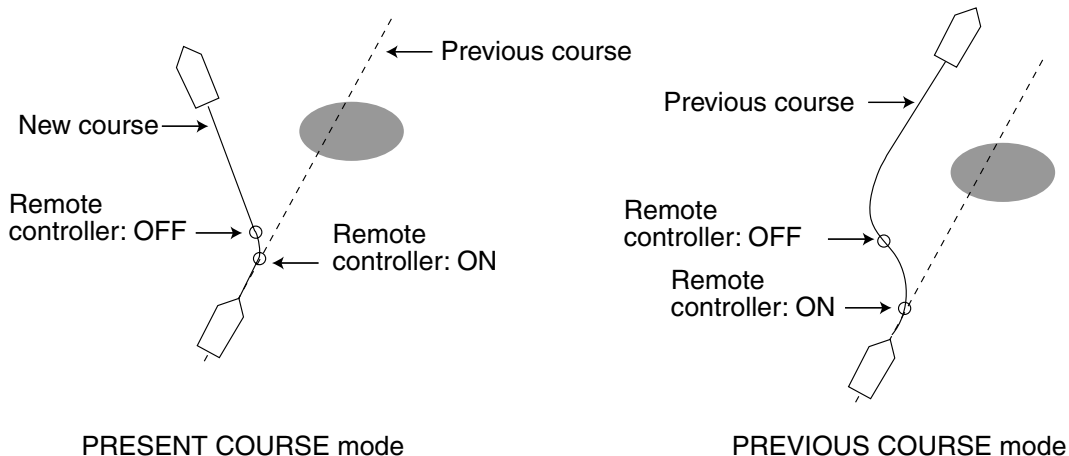

1. Open the [OTHER MENU] followed by the [AUTO OPTION] menu.
2. Rotate the **Course control** knob to select [CSE AFTER REMOTE] then push the knob.



3. Rotate the **Course control** knob to select desired option.
4. Push the **Course control** knob to finish.

## 4.5 Nav Data Source

Select the source of nav data to use in the NAV mode.

1. Select [OTHER MENU] followed by [NAV OPTION].
2. Rotate the **Course control** knob to select [NAV DATA SOURCE] then push the knob.

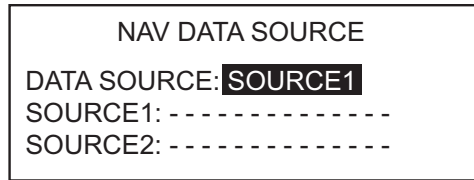

3. Rotate the **Course control** knob to select [DATA SOURCE] then push the knob.



4. Rotate the **Course control** knob to select source then push the knob. If you have more than one source of nav data, you can select [BOTH]. In this case, the nav data fed by [SOURCE2] is used when that of [SOURCE1] is not available.
5. Rotate the **Course control** knob to select [SOURCE1] then push the knob.



If you have some equipment which outputs nav data, the name appears in the window. In the example above, a NavNet 3 equipment, with unique number of 000C2F, is connected.

6. Rotate the **Course control** knob to select source then push the knob. If you have more than one device that outputs nav data, you can select it at [SOURCE2].

**Note:** If you have NavNet vx2 equipment connected and it is synchronized with the NAVpilot ([NAVNET2] turned on in the [NAV OPTION] menu, [SOURCE2] is automatically selected.

## 4.6 NavNet vx2 Synchronization

The NAVpilot goes to the NAV mode when it receives a P sentence (proprietary FURUNO sentence) from a NavNet vx2 equipment. For example, “autopilot information”. You can turn this feature on or off as follows:

1. Open the [OTHER MENU] followed by the [NAV OPTION] menu.
2. Rotate the **Course control** knob to select [NAVNET2] then push the knob.



3. Rotate the **Course control** knob to select [OFF] or [ON].
4. Push the **Course control** knob to finish.

## 4.7 SYSTEM SETUP Menu

The [SYSTEM SETUP] menu provides various functions which once set do not require frequent adjust. Set the items in this menu according to operational needs, current environment, etc. To open this menu, select [OTHER MENU] followed by [SYSTEM SETUP].

Page 1	Page 2	Page 3
SYSTEM SETUP KEY BEEP: <b>OFF</b> BUZZER VOL: LARGE ARROW KEY: DODGE TURN ANGLE: 15 KEY LOCK: UNLOCK PANEL DIMMER: 8 PASSWORD: 0000 PASSWORD FUNCTION: OFF RECEIVE SCREEN: OFF	SYSTEM SETUP SAVE USER SETTING: NO LOAD USER SETTING: NO SAVE DISPLAY SETTING: NO LOAD DISPLAY SETTING: NO ALARM LOG SIM/DEMO: OFF DIAGNOSTIC: OFF DISPLAY DATA SELECT MENU	SYSTEM SETUP SYSTEM DATA

*SYSTEM SETUP menu (shown: NAVpilot-700)*

### SYSTEM SETUP menu description

Item	Description	Options
[KEY BEEP]	Turn the key beep on or off.	[ON], [OFF]
[BUZZER VOL]	Set the volume of the buzzer, on the NAVpilot-700.	[SMALL], [LARGE]
[ARROW KEY]	Set the function of an arrow key when pressed to dodge an obstruction in the AUTO and WIND modes.	[DODGE], [5°], [10°], [MANUAL]. For [MANUAL], select degree of turn from 1°-90°.
[TURN ANGLE]	Set the angle of User turn in the Turn mode.	15°-360°, 15° steps
[KEY LOCK]	Prevent operation of the control unit.	[LOCK], [UNLOCK]. The "LOCK" icon (🔒) appears when [LOCK] is selected.
[PANEL DIMMER]	Set the backlighting level for the panel dimmer.	1-8
[PASSWORD]	Assign a four-digit password to use to unlock the keys and menu on the control unit.	0000-9999
[PASSWORD FUNCTION]	Activates or deactivates password requirement. Select ON to require a password to access menus. If the password is entered correctly, the menu becomes operative and the option setting for this item changes to OFF.	[ON], [OFF]

#### 4. HOW TO CUSTOMIZE YOUR NAVPILOT

Item	Description	Options
[RECEIVE SCREEN]	For multiple control units, you can copy the settings of one control unit to another. When you receive settings from a control unit of a different size than own, the following rule applies: <u>1DIN</u> <u>2DIN</u> 1BOX    2BOXES 2BOXES 3BOXES	[NO], 1-6 (actual number depends on number of control units connected)
[SAVE USER SETTING]	Save current settings as user default settings.	[NO], [YES]
[LOAD USER SETTING]	Load user default settings. The equipment is automatically restarted to restore saved user settings.	[NO], [YES]
[SAVE DISPLAY SETTING]	Save all display-related settings.	[NO], [YES]
[LOAD DISPLAY SETTING]	Load currently saved display-related settings.	[NO], [YES]
[ALARM LOG]	Show the alarms generated. See section 3.13.	
[SIM/DEMO]	Activate and deactivate the demonstration mode. DO NOT use this function on board your boat; it is intended for use by service technicians. "SIM" appears at the top right corner when the simulation mode is enabled.	[OFF], [DEMO SLIDE SHOW], [SIMULATOR],[SIM W/DRIVE].
[DIAGNOSTIC]	Perform various diagnostics on the NAVpilot system. See section 5.3.	
[DISPLAY DATA SELECT MENU]	Set and select the data to show in the STBY, AUTO, NAV, WIND, and FishHunter™ modes. See page 1-11 for the procedure.	
[SYSTEM DATA]	Show system data. See section 5.4.	

## 4.8 Menu Shortcuts

You can create menu shortcuts to the STBY mode menu for menu items which you often use. Up to 20 shortcuts can be created.

### 4.8.1 How to create a menu shortcut

The procedure below shows you how to create a menu shortcut for the arrival alarm.

1. Open the STBY mode menu.
2. Select the menu item for which you want to create a menu shortcut. For example, select [ARRIVAL ALARM] from the [ALARM] menu.
3. Long press the **MENU** key to show the following prompt.

```
+++ MENU ENTRY +++
ARE YOU SURE?

YES-PUSH ENTER KNOB
NO-PUSH MENU KEY
```

4. Press the **Course control** knob to create the shortcut. The shortcut is then added to the STBY mode menu.

```
MESSAGE
SENSOR IN USE
SEA STATE: FULL-AUTO
MANUAL PARAMETER
ADVANCED AUTO:  ON
ARRIVAL ALARM: OFF ← Menu shortcut
OTHER MENU
```

### 4.8.2 How to delete a menu shortcut

1. Open the STBY mode menu.
2. Select the menu item to delete.
3. Long press the **MENU** key to show the following prompt.

```
--- MENU DELETE ---
ARE YOU SURE?

YES-PUSH ENTER KNOB
NO-PUSH MENU KEY
```

4. Press the **Course control** knob to delete the shortcut.

#### 4. HOW TO CUSTOMIZE YOUR NAVPILOT

This page is intentionally left blank.



# 5. MAINTENANCE, TROUBLE-SHOOTING

This chapter provides the maintenance and troubleshooting procedures.

## WARNING

**ELECTRICAL SHOCK HAZARD**  
Do not open the equipment.

This equipment uses high voltage that can cause electrical shock. Only qualified persons can work inside the equipment.

## NOTICE

**Do not apply paint, anti-corrosive sealant or contact spray to plastic parts or equipment coating.**

Those items contain products that can damage plastic parts and equipment coating.

## 5.1 Preventive Maintenance

Regular maintenance is necessary for best performance. Create a maintenance schedule which includes the items shown below.

Item	Check point	Remedy
Control unit connectors	Check for tight connection.	Tighten loosened connectors.
LCD	Dust on the LCD dims picture.	Clean the LCD carefully to prevent damage, with tissue paper and an LCD cleaner. To remove dirt or salt deposits, use an LCD cleaner and wipe slowly with lens paper so as to dissolve the dirt or salt. Change the paper frequently so the salt or dirt will not damage the LCD. Do not use solvents like thinner, acetone or benzine for cleaning.
Ground terminal	Check for tight connection and corrosion	Clean or replace the ground wire as necessary.

## 5.2 Replacement of Fuse

Two fuses (125V 4A) in the processor unit protect the equipment from reverse polarity of the ship's mains and equipment fault. If a fuse blows, you cannot turn on the power. Have a qualified technician check the set.

 <b>WARNING</b>
<p><b>Use the proper fuse.</b></p> <p>Use of a wrong fuse can cause fire or damage the equipment.</p>

Parts name	Type	Code no.	Remarks
Fuse	FGMB 125V 4A PBF	000-157-482-10	Supplied as spare parts

## 5.3 Diagnostics

Your NAVpilot contains the diagnostics that check the processor unit, control unit, NMEA 0183 input/output, CAN bus, keyboard, screen, rudder, and helm (Accu-Steer FPS 12V/24V helm sensor only). The tests are for use by service technicians, but you can do the tests to help the technician in troubleshooting.

### 5.3.1 Diagnostic menu

1. Press the **MENU** key to open the menu.
2. Rotate the **Course control** knob to select [OTHER MENU] then push the knob.
3. Rotate the **Course control** knob to select [SYSTEM SETUP] then push the knob.
4. Rotate the **Course control** knob to select the current setting for [DIAGNOSTIC] then push the knob.

<p><b>OFF</b></p> <p>PROCESSOR UNIT  CONTROL UNIT  NMEA0183 TEST  CAN BUS TEST  KEYBOARD TEST  SCREEN TEST  RUDDER TEST  HELM SENSOR*</p>
---

\*: Appears when the Accu-Steer FPS 12V/24V is installed.

5. Rotate the **Course control** knob to select the item to test then push the knob to start the test.
6. Press the **MENU** key continuously to quit the test and close the menu.

### 5.3.2 Processor unit test

This test checks the processor unit for correct operation. Open the diagnostic test options window, select [PROCESSOR UNIT] then push the **Course control** knob. The results for the ROM, RAM and RUDDER ANGLE are shown as OK or NG. If NG appears, repeat the test. If the error condition continues, contact your dealer.

PROCESSOR UNIT ID: 39768	
ROM: OK 6454007-**. **	
6454009-**. **	
RAM: OK BACKUP: OK	
RUDDER ANGLE: OK 0°	For Fantum Feedback™, "FANTUM FEEDBACK" is displayed.
BYPASS/CLUTCH: 0.7A	
RC1/RC2: OFF -1° /OFF -2°	Not shown with Fantum Feedback™.
INPUT VOLTAGE: 24.5 V	
PORT1/PORT2/CAN: - /- /OK	
CAN ID: 39713 CPU/PWR: */*	

\*: Version no.

\*\* \*\*: Program version no.

[ROM]: "OK" for normal, program number

[RAM]: RAM test, "OK" for normal

[BACKUP]: Backup data test, "OK" for normal.

[RUDDER ANGLE]: "OK" for normal, actual rudder angle.

[BYPASS/CLUTCH]: Bypass/clutch amperage. ("NOT PRESENT" shown in case of no connection.)

[RC1/RC2]: Remote controller state (ON or OFF) and rudder signal input value. "NOT USED" shown in case of no connection.

[INPUT VOLTAGE]: Voltage.

[PORT1/PORT2/CAN]: I/O test for PORT1/PORT2/CAN (CAN bus). OK for normal.

[CAN ID]: ID of CAN bus equipment.

### 5.3.3 Control unit test

This test checks the control unit for correct operation. Open the diagnostic test options window, select [CONTROL UNIT] then push the **Course control** knob. The results for [ROM], [RAM], [BACKUP], and [COMMUNICATION] are shown as OK or NG (No Good). If NG appears, repeat the test. If the error condition continues, contact your dealer.

```

CONTROL UNIT
ROM: OK 6454011-**. **
        6454010-**. **
RAM: OK  BACKUP: OK
COMMUNICATION: OK
CONTROLLER ID: 2
CAN ID: 0 CPU:*

```

\*: Version no.

\*\* \*\*: Program version no.

### 5.3.4 NMEA0183 test

This test checks for correct input and output of NMEA 0183 data from PORT1 and PORT2. The test is for service technicians and requires a special test connector. (If the test is done without the connector, the results are shown as "- -".)

Open the diagnostic test options window, select [NMEA0183 TEST] then push the **Course control** knob. The results are shown as OK or "- -". For any "- -", repeat the test. If the error condition continues, contact your dealer.

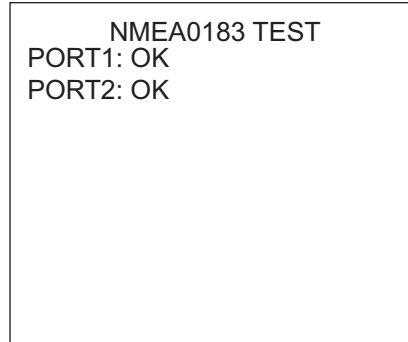

### 5.3.5 CAN bus test

This test checks the CAN bus network. Open the diagnostic test options window, select [CAN BUS TEST] then push the **Course control** knob. The results are shown as OK or NG (No Good). ("- -" appears when there is no CAN bus connection.) If NG appears, repeat the test. If the error condition continues, contact your dealer.

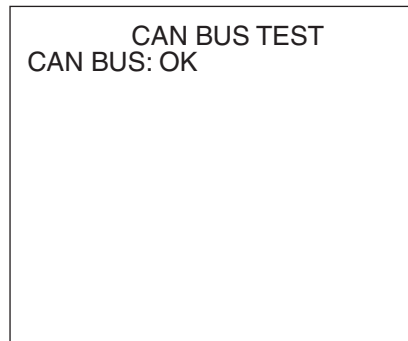

### 5.3.6 Keyboard test

The keyboard test checks the key panel on the control unit. Open the diagnostic test options window, select [KEYBOARD TEST] then push the **Course control** knob. Press each key and the **Course control** knob. The related on-screen location fills in black if the key or knob is normal. Rotate the **Course control** knob. The figure inside the circle on the screen counts up or down with knob rotation.

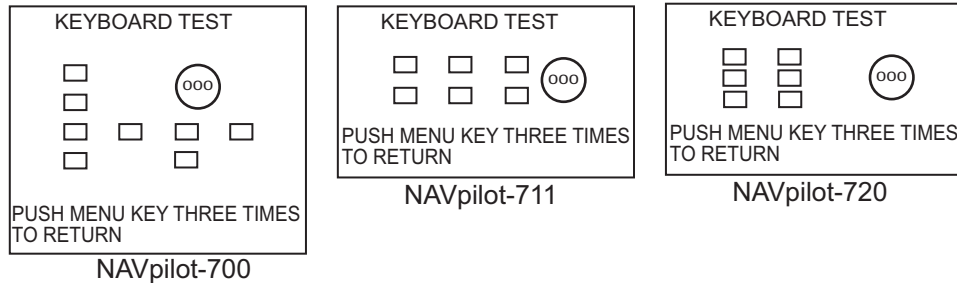

### 5.3.7 Screen test

The screen test checks the control unit for correct presentation of black and white tones. Open the diagnostic test options window, select [SCREEN TEST] then push the **Course control** knob. Push the **Course control** knob to change the screen. Press the **MENU** key continuously to quit the test and close the menu.

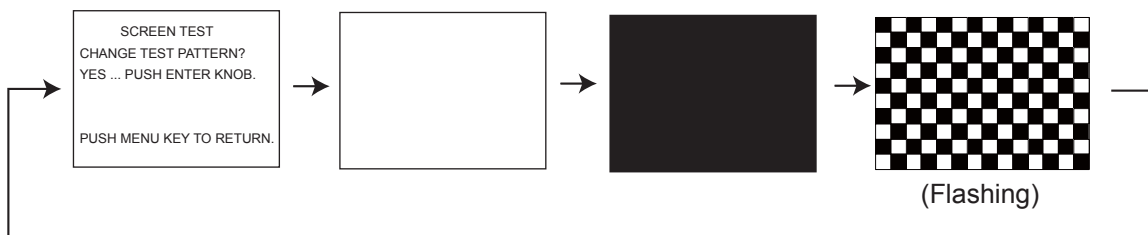

### 5.3.8 Rudder test

The rudder test checks drive type, presence or absence of bypass/clutch circuit, rudder deadband, rudder speed, rudder duty\*, and rudder angle.

\* The rudder control value required to obtain rudder speed of 5°/sec. For solenoid systems, ship's characteristics=sailboat, the indication is 100% always. For ship's characteristics=sailboat, the message "Rudder speed is too slow to control the vessel. The vessel may not be controlled properly." does not appear when the rudder speed is greater than 5°/sec; however, this is not a sign of malfunction.

#### **When the rudder reference unit is installed**

Open the diagnostic test options window, select [RUDDER TEST] then push the **Course control** knob. You are asked to center the rudder. Center the rudder then push the **Course control** knob to start the test.

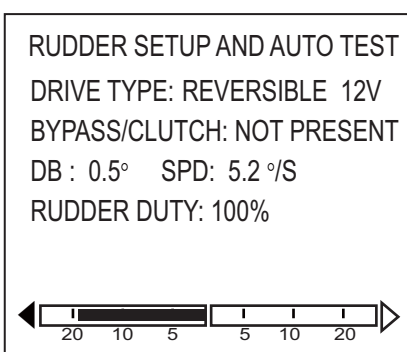

The result display

#### **For Fantum Feedback™**

**Note 1:** For Fantum Feedback™, the rudder test does not check presence or absence of bypass/clutch circuit, the rudder deadband, and rudder angle.

**Note 2:** For Fantum Feedback™, this rudder test is the different from it at installation in the following points.

- The adjustment of the rudder speed is not available.
- The result calculated by the rudder test is not reflected to the control of the NAVpilot.

1. Select [RUDDER TEST] in the [DIAGNOSTIC] menu then push the **Course control** knob.

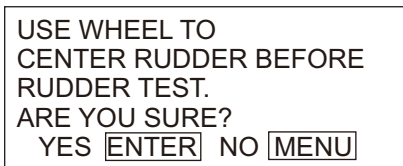

2. Center the rudder then push the **Course control** knob.
3. Turn the helm or press the ◀ (or ▶) key hard-over to PORT/STBD then push the knob.
4. Long press the ◀ (or ▶) key hard-over to the opposite direction from step 3.

5. When the rudder is reached to hard limit, release the ◀ (or ▶) key.

```
HAS THE RUDDER REACHED
THE HARD LIMIT?

YES [ENTER]    NO [MENU]
```

6. If the rudder reached to the hard limit properly, select [YES]. If not, select [NO] to display the message as below.

```
RUDDER TEST IS
UNCOMPLETED.
RETRY?
YES [ENTER] NO [MENU]
```

If retry the rudder test, select [YES] and go back to step 3. If not, select [NO] to abort the rudder test.

7. The result of the rudder test is displayed.

```
RUDDER TEST
DRIVE TYPE: REVERSIBLE 12V
SPD: 5.2 %S
RUDDER DUTY: 100%
RUDDER DRIVE LEVEL: 6
PUSH MENU KEY TO RETURN
```

The result display

### **The result message**

When the rudder test is completed, a message announces the results of the test.

<b>Message</b>	<b>Meaning</b>
Rudder test completed.	Rudder tested OK.
Rudder speed is too fast to control the vessel. The vessel may not be controlled properly.	Rudder speed is too fast.
Rudder speed is too slow to control the vessel. The vessel may not be controlled properly.	Rudder speed is too slow.
Deadband is too big to control the vessel. The vessel may not be controlled properly.*	Deadband is too large.
Deadband is too big rudder speed is too fast to control the vessel. The vessel may not be controlled properly.*	Deadband is too large; rudder speed is too fast.
Deadband is too big rudder speed is too slow to control the vessel. The vessel may not be controlled properly.*	Deadband is too large; rudder speed is too slow.
Rudder test failed.*	

\*: Not shown with Fantum Feedback™.

### 5.3.9 Helm sensor test

The helm sensor test checks the connection between the Accu-Drive FPS 12V/24V helm sensor and the processor unit. (The test is not available for other types of helm sensors.) Turn the helm to port or starboard and then in the opposite direction. If the connection is normal, the message "HELM SENSOR TEST COMPLETED." appears. For failure, "HELM SENSOR TEST FAILED." appears. Check that your helm sensor is Accu-Drive FPS 12V/24V. Also, check that the helm sensor is correctly connected to TB4.

**Note:** The helm sensor test is not available with Fantum Feedback™.

## 5.4 System Data

The system data display allows you to confirm the equipment and drive system status. To show this display, open the [SYSTEM MENU], select [SYSTEM DATA] then push the **Course control** knob.

INPUT VOLTAGE: 24.4 V CONTROLLER ID: 2 DRIVE TYPE: REVERSIBLE 24V BYPASS/CLUTCH: NOT PRESENT P/C TEMP: 71.3°F/91.1°F MOTOR DRIVE CUR: 10.0 A BYPASS/CLUTCH CUR*: 0.0 A
--

**[INPUT VOLTAGE]:** Voltage input to the NAVpilot.

**[CONTROLLER ID]:** ID of the controller that displays the system data.

**[DRIVE TYPE]:** Drive type used with the NAVpilot.

**[BYPASS/CLUTCH]\*:** Presence or absence of bypass/clutch.

**[P/C TEMP]:** Temperature of processor unit / control unit.

**[MOTOR DRIVE CUR]:** Motor drive current. Max. value is 25.0 A.

**[BYPASS/CLUTCH CUR]\*:** Bypass/clutch current. Max. value is 3.0 A.

\*: Not shown with Fantum Feedback™.



## 5.5 Messages

Your equipment displays messages to alert you to potential equipment problem and operation status.

### 5.5.1 Message pop-up display

When the system detects alarm violation, error, etc., the buzzer sounds and an error message pop-up display appears. The illustration below shows the message for rudder drive error. For any error message, turn off the NAVpilot and have a qualified technician check the drive circuit.

RUDDER DRIVE ERROR  
 PLEASE TURN OFF AND  
 CHECK DRIVE CIRCUIT

### 5.5.2 Message board

The message board contains the information about the latest alarm/error messages. To show the message board, press the **MENU** key to open the menu. [MESSAGE] is selected; push the **Course control** knob.

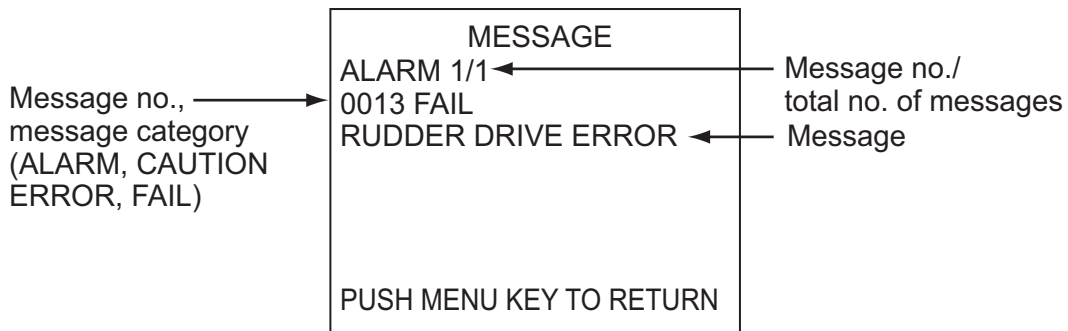

### 5.5.3 Message description

Error no.	Error message	Meaning, remedy
<b>Alarm</b>		
5101	"DEVIATION ALARM"	Deviation alarm violated.
5103	"WIND DEVIATION ALARM"	Wind deviation alarm violated.
5105	"ARRIVAL ALARM"	You are nearing a waypoint.
5107	"CROSS TRACK ERROR"	Your boat is off course by the amount set on the XTE alarm.
5203	"THE PRESET TIME HAS PASSED"	The watch alarm has activated. Operate any key to confirm presence.
5301	"HEADING CHANGE ALARM"	Heading change alarm violated.
5303	"TRUE WIND SPEED ALARM"	True wind alarm violated (sailboats only).

5. MAINTENANCE, TROUBLESHOOTING

<b>Error no.</b>	<b>Error message</b>	<b>Meaning, remedy</b>
5305	"APP WIND SPEED ALARM"	Apparent wind alarm violated (sailboats only).
5307	"SPEED ALARM"	Speed alarm violated.
5309	"WATER TEMP ALARM"	Water temperature alarm violated.
5311	"DEPTH ALARM"	Depth alarm violated.
5313	"TRIP ALARM"	Your boat has travelled the distance set for the trip alarm.
<b>Error</b>		
1101	"TOO FAST TO GO FISHING MODE. PLEASE SLOW DOWN LESS THAN 10 kn."	Set speed below 10 knots then go to respective mode.
1201	"COMMUNICATION ERROR"	No communication between processor unit and control unit. Turn off power.
1203	"FU REMOTE CONTROLLER ERROR"	Check remote controller.
1301	"MISSING HEADING DATA"	Check heading sensor.
1303	"HEADING DATA IS SHIFTED"	Heading data has changed abruptly. Check heading sensor.
1305	"NO SPEED DATA. PLEASE CHECK SPEED SOURCE OR ENTER MANUAL SPEED VALUE IN PARAMETER SETUP."	Check the speed source or enter the speed manually.
1307	"NO WIND DATA"	Check wind sensor.
1309	"WIND DATA IS SHIFTED"	Wind data has changed abruptly. Check wind sensor.
1311	"NO NAV DATA. WAIT FOR 1 SECONDS."	Check nav data sensor.
1315	"DEGRADATION OF NAV DATA QUALITY"	Check nav data sensor.
1317	"NO POSITION DATA"	Check position-fixing equipment.
1901	"RATE SENSOR ERROR"	Check rate sensor.
1903	"BACKUP ERROR"	All user and engineer default settings are restored. Reenter installation settings.
<b>Fail</b>		
0001	"DRIVE UNIT ERROR"	Turn off power
0003	"DRIVE UNIT OVERLOAD"	Turn off power.
0005	"DRIVE UNIT IS OVER-HEATED"	Temperature of drive circuit is higher than 80°C(176°F). Turn off power.
0007	"BYPASS/CLUTCH DRIVE ERROR"	Bypass/clutch error. Turn off power.

<b>Error no.</b>	<b>Error message</b>	<b>Meaning, remedy</b>
0009	"BYPASS/CLUTCH IS OVER-LOADED"	Bypass/clutch overload. Turn off power.
0011	"BYPASS/CLUTCH IS SHORT-ED OUT"	Bypass/clutch is shorted. Turn off power.
0013	"RUDDER DRIVE ERROR"	Turn off power.
0017	"RUDDER ANGLE ERROR"	Turn off power.
0301	"COMMUNICATION ERROR"	No communication between processor unit and all control units. Turn off power.
<b>Notice</b>		
2001	"INPUT VOLTAGE IS UNDER LIMIT"	Input voltage under limit. Check power supply.
2003	"INPUT VOLTAGE IS OVER LIMIT"	Input voltage over limit. Check power supply.
2101	"NAV MODE PARAMETER ERROR"	Invalid parameter entered in NAV mode. Reenter parameter.
2105	"START TO TURN BY FISHING MODE"	Boat is starting to turn after dodge operation.
2107	"CIRCLE MODE STOPPED"	Circle mode was stopped.
2109	"MODE WAS CHANGED"	Steering mode changed.
2201	"WARNING. REMOTE CONTROLLER'S SW IS ON"	Remote controller switch is ON. Turn it OFF to continue operation.
2203	"THE SET TIME HAS PASSED"	Watch alarm has activated.
2301	"HEADING SOURCE ARE CHANGED"	Heading source changed.
2303	"WIND SOURCE ARE CHANGED"	Wind source changed.
2305	"POSITION SOURCE ARE CHANGED"	Position source changed.
2307	"SPEED SOURCE HAS CHANGED"	Source of speed changed.
2330	"ARRIVED AT WAYPOINT"	Arrival alarm alerts you to arrival at final waypoint.
2340	"WAYPOINT WAS CHANGED"	Switching to next waypoint.
2360	"NO WATER TEMP DATA"	Check water temperature sensor.
2362	"NO DEPTH DATA"	Check depth sensor.
2370	"HELM SENSOR ERROR"	Check helm sensor.
2901	"NO COMPASS ADJUSTMENT DATA"	Check heading sensor.

## 5.6 Sensor in Use Display

The SENSOR IN USE display provides a comprehensive list of the sensors connected to your NAVPILOT.

1. In the STBY mode, press the **MENU** key to show the STBY mode menu.

*NAVpilot-700*

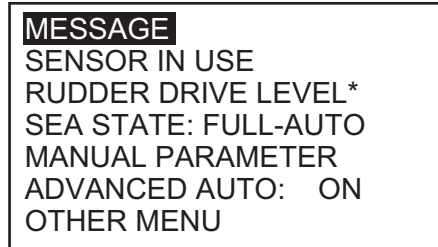

*NAVpilot-711/720*



\* Shown with Fantum Feedback™.

2. Rotate the **Course control** knob to select [SENSOR IN USE] then push the knob.

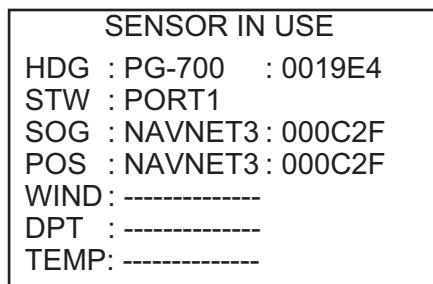

The display shows the source for each data and the equipment identifier number. For example the source of HDG is the FURUNO PG-700 and its equipment identifier number is 0019E4. Dashed lines indicate no connection or sensor is not currently active.

# APPENDIX 1 MENU TREE

## STBY mode menu

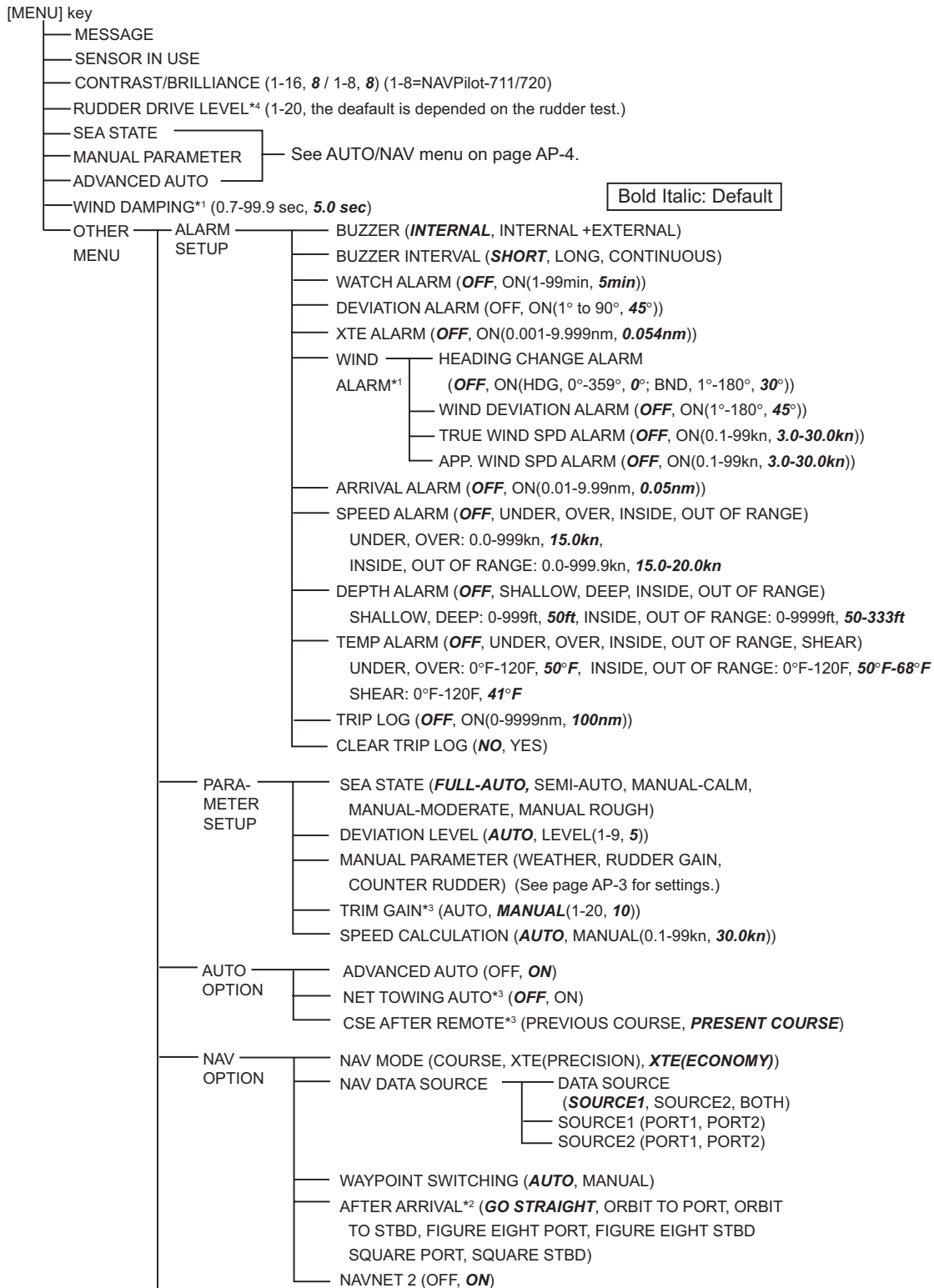

**Bold Italic: Default**

(Continued on next page)

\*1 [SHIP'S CHARACTERISTICS]=sailboat

\*2 [SHIP'S CHARACTERISTICS]=other than sailboat  
For Fantum Feedback™, only the [GO STRAIGHT] or [ORBIT TO STBD] are available.

\*3 Not shown with Fantum Feedback™.

\*4 Shown with Fantum Feedback™.

APPENDIX 1 MENU TREE

(Continued from previous page)

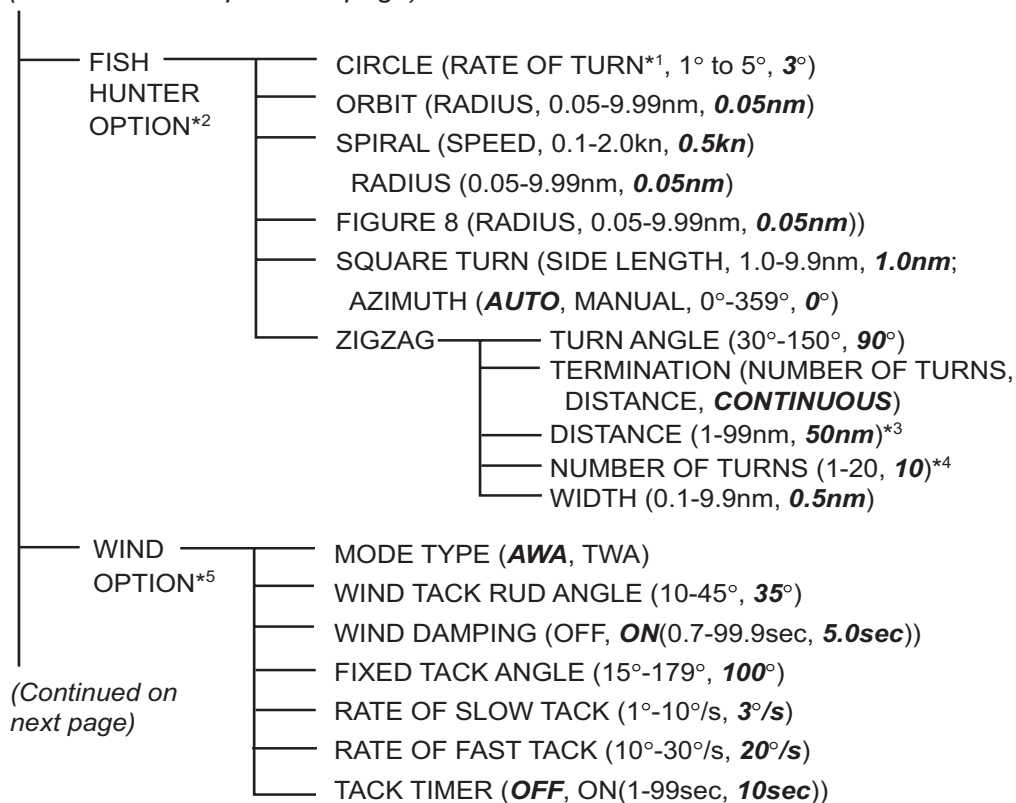

(Continued on next page)

\*1 Cannot be set higher than [RATE OF TURN] set with [SHIP'S CHARACTERISTICS] (at installation).

\*2 [SHIP'S CHARACTERISTICS]=other than sailboat Not shown with Fantum Feedback™.

\*3 Visible when [TERMINATION] is set for [DISTANCE].

\*4 Visible when [TERMINATION] is set for [NUMBER OF TURNS].

\*5 [SHIP'S CHARACTERISTICS]=sailboat Not shown with Fantum Feedback™.

(Continued from previous page)

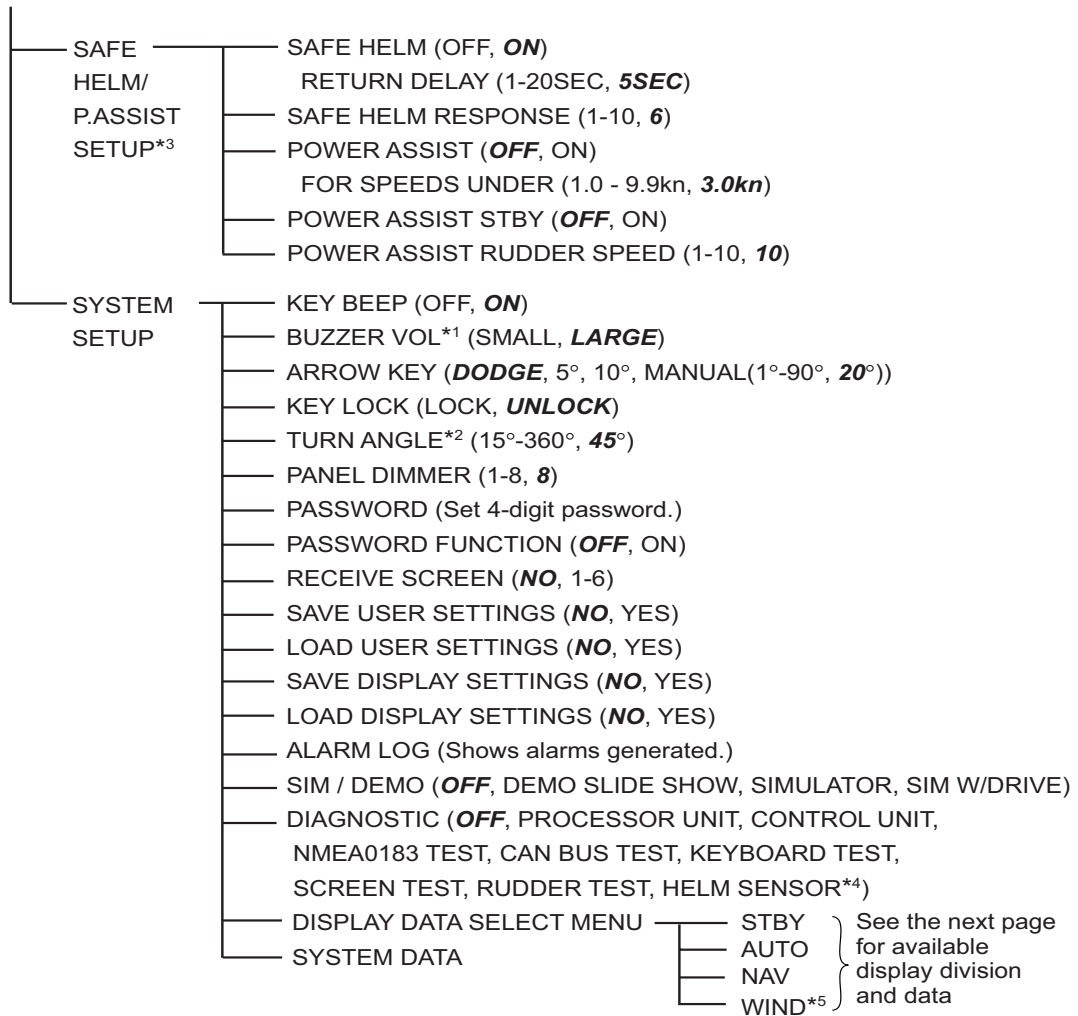

\*1 NAVpilot-700 only

\*2 [SHIP'S CHARACTERISTICS]=other than sailboat

\*3 Not shown with Fantum Feedback™.

\*4 Available with the Accu-Steer FPS 12V/24V type drive.

\*5 [SHIP'S CHARACTERISTICS]=sailboat

## APPENDIX 1 MENU TREE

### AUTO, NAV, WIND menu

[MENU] key

- MESSAGE (Shows error messages.)
- SENSOR IN USE
- CONTRAST/BRILLIANCE (1-16, **8** / 1-8\*<sup>1</sup>, **8**)
- RUDDER DRIVE LEVEL\*<sup>2</sup> (1-20, the default is depended on the rudder test.)
- SEA STATE (**FULL-AUTO**, SEMI-AUTO, MANUAL-CALM, MANUAL-MODERATE, MANUAL-ROUGH)
- MANUAL PARAMETER
  - WEATHER (CALM, 0°-10°, **1**; MODERATE, 0°-10°, **2**; ROUGH, 0°-10°, **3**)
  - RUDDER GAIN (CALM, 1-20, **3**; MODERATE, 1-20, **5**; ROUGH, 1-20, **10**)
  - COUNTER RUDDER (CALM, 0-20, **10**; MODERATE, 0-20, **2**; ROUGH, 0-20, **4**)
- ADVANCED AUTO (OFF, **ON**)
- WIND DAMPING\*<sup>3</sup> (0.7-99.9 sec, **5.0 sec**)
- OTHER MENU
  - BUZZER VOL\*<sup>4</sup> (SMALL, **LARGE**)
  - ARROW KEY (**DODGE**, 5°, 10°, MANUAL(1°-90°, **20**°))
  - DISPLAY DATA SELECT MENU (See "1.4.4 How to select displays from the menu".)
  - SYSTEM DATA

\*<sup>1</sup> NAVpilot-711, 720

\*<sup>2</sup> Shown with Fantum Feedback™.

\*<sup>3</sup> [SHIP'S CHARACTERISTICS]=sailboat

\*<sup>4</sup> NAVpilot-700



## SPECIFICATIONS OF AUTOPILOT NAVpilot-700/711/720

### 1 CONTROL UNIT

1.1	Display	Monochrome dot matrix LCD
1.2	Effective display area	
	FAP-7001	85.2 x 85.2 mm (160 x 160 dot)
	FAP-7011/7021	85.2 x 43.6 mm (160 x 80 dot)
1.3	Backlight	8 steps
1.4	Contrast	16 steps
1.5	Useable set	6 sets

### 2 PROCESSOR UNIT

2.1	Rudder mode	STBY, Auto, Dodge, Remote, Advanced auto*, Navigation*, Wind*, FishHunter <sup>TM</sup> *
2.2	Weather mode	AUTO, MANUAL-CALM/ MODERATE/ ROUGH
2.3	Rudder gain	AUTO/1-20 (Manual)
2.4	Counter rudder	AUTO/0-20 (Manual)
2.5	Trim gain	AUTO/1-20 (Manual)
2.6	Course change speed	1-30 deg/s
2.7	Rudder angle settings	1-60 deg
2.8	Alarm	Heading deviation, Cross-track error, Ship's speed*, Depth*, Water temperature*, Wind*, Watch, Log trip*
2.9	Motor/ Solenoid drive	25A continuous, 50A for 5 seconds
2.10	Clutch/ Bypass drive	3A

\*: external data required

### 3 INTERFACE

3.1	Number of port	
	NMEA0183	2 ports
	CAN bus	1 port
	Relay contact output	2 ports, alarm and status, 30V max., 3A max.
	Contact signal input	2 ports, event switch control
	USB	1 port, for maintenance only
3.2	Data sentences	NMEA 0183 Ver1.5/2.0/3.0
	Input	AAM, APB, BOD, BWC, BWR, DBT, DPT, GGA, GLL, GNS, HDG, HDM, HDT, MTW, MWV, ROT, RMB, RMC, THS, TLL, VHW, VTG, VWR, VWT, XTE, ZDA
	Output	DBT, DPT, GGA, GLL, GNS, HDG, HDM, HDT, MTW, MWV, RMB, RMC, ROT, RSA, VHW, VTG, VWR, VWT, ZDA
3.3	CAN bus PGN (NMEA2000)	
	Input	059392/904,060928,061184,126208/464/720/992/996,

Output 127250/251/258/488/489,128259/267,  
129025/026/029/033/283/284/285,  
130306/310/311/312/313/314/577/880  
059392/904,060928,061184,126208/464/720/992/996,  
127237/245/250/251/258,128259/267,  
129025/026/029/033/283/284/285, 130306/310/311/312/822/823

#### **4 POWER SUPPLY**

12-24 VDC: 4.0-2.0 A (control unit: 6 sets)

#### **5 ENVIRONMENTAL CONDITION**

- 5.1 Ambient temperature -15°C to +55°C
- 5.2 Relative humidity 95% at 40°C
- 5.3 Degree of protection
  - Control unit IP56
  - Processor unit IP20
  - Rudder reference unit IPX5
- 5.4 Vibration IEC 60945 Ed.4

#### **6 UNIT COLOR**

- 6.1 Control/processor unit N2.5
- 6.2 Remote controller N3.0 (FAP-5552/6232), N1.5 (FAP-6212/6222)
- 6.3 Rudder reference unit N1.5
- 6.4 Junction box N3.0

# INDEX

## **Numerics**

- 180-degree turn..... 2-12
- 360-degree turn..... 2-12

## **A**

- ADVANCED AUTO mode ..... 2-4
- Alarm buzzer ..... 3-2
- Alarm log ..... 4-10
- Alarm menu ..... 3-1
- Alarms
  - alarm menu ..... 3-1
  - apparent wind speed alarm ..... 3-9
  - arrival alarm ..... 3-5
  - buzzer ..... 3-2
  - buzzer interval ..... 3-2
  - depth alarm ..... 3-6
  - deviation ..... 3-3
  - heading change alarm..... 3-8
  - speed alarm ..... 3-5
  - trip distance alarm..... 3-7
  - true wind speed alarm..... 3-9
  - watch alarm ..... 3-3
  - water temperature alarm ..... 3-6
  - wind deviation alarm ..... 3-9
  - XTE alarm ..... 3-4
- Apparent wind speed alarm ..... 3-9
- Arrival alarm ..... 3-5
- Arrow key function..... 4-9
- AUTO mode ..... 2-2

## **B**

- Brilliance adjustment ..... 1-4
- Button-type remote controller (FAP-6221, FAP-6222) ..... 2-20
- Buzzer interval ..... 3-2
- Buzzer volume ..... 4-9

## **C**

- CAN bus test ..... 5-4
- Circle turn..... 2-15
- Compass, rudder display ..... 1-9
- Contrast adjustment ..... 1-4
- Control description
  - NAVpilot-700 ..... 1-1
  - NAVpilot-711 ..... 1-2
  - NAVpilot-720 ..... 1-2
- Control unit test ..... 5-3
- Counter rudder setting ..... 4-4
- Course after remote operation ..... 4-7

## **D**

- Depth alarm..... 3-6
- Depth display ..... 1-9
- Deviation alarm ..... 3-3
- Diagnostics
  - control unit test..... 5-3

- diagnostics menu ..... 5-2
- helm sensor test..... 5-8
- keyboard test..... 5-5
- NMEA 0183 test ..... 5-4
- processor unit test..... 5-3
- rudder test ..... 5-6
- screen test..... 5-5
- Dial-type remote controller (FAP-5551, FAP-5552) ..... 2-19
- Display data in AUTO mode..... 1-13, 4-10
- Display mode
  - NAVpilot-700 ..... 1-5
  - NAVpilot-711/720 ..... 1-6
- Display settings saving, loading ..... 4-10
- DODGE mode
  - AUTO and NAV modes ..... 2-22
  - AUTO mode ..... 2-23
  - STBY mode ..... 2-22
- Dodge-type remote controller (FAP-6231, FAP-6232) ..... 2-20

## **E**

- Engine speed display ..... 1-10

## **F**

- Fantom Feedback™ ..... vii
- Figure-eight turn..... 2-17
- FishHunter™ mode
  - circle turn..... 2-15
  - figure-eight turn ..... 2-17
  - orbit turn ..... 2-16
  - spiral turn ..... 2-16
  - square turn ..... 2-17
  - zigzag turn..... 2-18
- FU DODGE mode ..... 2-22
- Fuse replacement ..... 5-2

## **H**

- Heading change alarm ..... 3-8
- Helm sensor test ..... 5-8
- Highway display ..... 1-10

## **K**

- Key beep ..... 4-9
- Key lock..... 4-9
- Keyboard test ..... 5-5

## **M**

- Maintenance..... 5-1
- Menu shortcuts
  - creating ..... 4-11
  - deleting..... 4-11
- Menu tree ..... AP-1
- Messages ..... 5-9

## INDEX

### **N**

- NAV mode
  - boat's behavior after switching waypoint...2-9
  - data source .....4-8
  - description.....2-5
  - sailing method for.....2-8
  - waypoint switching method .....2-9
- NavNet vx2 synchronization .....4-8
- Net towing .....4-7
- NFU dodge in STBY mode .....2-23
- NMEA 0183 test.....5-4

### **O**

- Orbit turn .....2-16

### **P**

- Panel dimmer .....4-9
- Parameter setup menu .....4-1
- Password .....4-9
- Power assist mode.....2-33
- POWER/BRILL key (NAVpilot-700) .....1-3
- Processor unit test .....5-3

### **R**

- REMOTE mode.....2-19
- Response .....2-10
- Rudder display .....1-10
- RUDDER DRIVE LEVEL .....4-6
- Rudder gain setting.....4-3
- Rudder test .....5-6

### **S**

- Safe helm mode.....2-31
- Screen test.....5-5
- Sea state
  - automatic setup.....4-2
  - manual setup.....4-3
- Simulation mode .....4-10
- Speed alarm.....3-5
- Speed calculation.....4-6
- Spiral turn.....2-16
- Square turn .....2-17
- STBY mode
  - description.....2-1
  - selection of data .....1-13
- STBY/POWER key (NAVpilot-720) .....1-3
- Synchronization of control units .....4-10
- System configuration ..... vii
- System data .....5-8

### **T**

- TACK mode
  - AUTO mode .....2-25
  - damping interval for wind data .....2-30
  - fast, slow tracking rate of turn .....2-26
  - fixed tack angle .....2-27
  - max rudder angle .....2-29
  - tack timer.....2-31
  - WIND mode.....2-27
- Trim gain setting .....4-5
- Trip distance alarm .....3-7

- Trip distance reset.....3-7
- True wind speed alarm.....3-9
- Turn angle in TURN mode .....4-9
- TURN mode
  - 180-degree turn.....2-12
  - 360-degree turn.....2-12
  - turn selection.....2-11
  - user turn .....2-12

### **U**

- User settings saving, loading .....4-10
- User turn .....2-12

### **W**

- Watch alarm .....3-3
- Water temperature alarm .....3-6
- Water temperature display .....1-11
- Weather setting .....4-3
- Wind deviation alarm.....3-9
- Wind display .....1-11
- WIND mode
  - starting .....2-23
  - wind angle .....2-24

### **X**

- XTE alarm .....3-4

### **Z**

- Zigzag turn .....2-18

# FURUNO Worldwide Warranty for Pleasure Boats (Except North America)

This warranty is valid for products manufactured by Furuno Electric Co. (hereafter FURUNO) and installed on a pleasure boat. Any web based purchases that are imported into other countries by anyone other than a FURUNO certified dealer may not comply with local standards. FURUNO strongly recommends against importing these products from international websites as the imported product may not work correctly and may interfere with other electronic devices. The imported product may also be in breach of the local laws and mandated technical requirements. Products imported into other countries as described previously shall not be eligible for local warranty service.

For products purchased outside of your country please contact the national distributor of Furuno products in the country where purchased.

This warranty is in addition to the customer's statutory legal rights.

## 1. Terms and Conditions of Warranty

FURUNO guarantees that each new FURUNO product is the result of quality materials and workmanship. The warranty is valid for a period of 2 years (24 months) from the date of the invoice, or the date of commissioning of the product by the installing certified dealer.

## 2. FURUNO Standard Warranty

The FURUNO standard warranty covers spare parts and labour costs associated with a warranty claim, provided that the product is returned to a FURUNO national distributor by prepaid carrier.

The FURUNO standard warranty includes:

- Repair at a FURUNO national distributor
- All spare parts for the repair
- Cost for economical shipment to customer

## 3. FURUNO Onboard Warranty

If the product was installed/commissioned and registered by a certified FURUNO dealer, the customer has the right to the onboard warranty.

The FURUNO onboard warranty includes

- Free shipping of the necessary parts
- Labour: Normal working hours only
- Travel time: Up to a maximum of two (2) hours
- Travel distance: Up to a maximum of one hundred and sixty (160) KM by car for the complete journey

## 4. Warranty Registration

For the Standard Warranty - presentation of product with serial number (8 digits serial number, 1234-5678) is sufficient. Otherwise, the invoice with serial number, name and stamp of the dealer and date of purchase is shown.

For the Onboard Warranty your FURUNO certified dealer will take care of all registrations.

## 5. Warranty Claims

For the Standard Warranty - simply send the defective product together with the invoice to a FURUNO national distributor. For the Onboard Warranty – contact a FURUNO national distributor or a certified dealer. Give the product's serial number and describe the problem as accurately as possible.

Warranty repairs carried out by companies/persons other than a FURUNO national distributor or a certified dealer is not covered by this warranty.

## 6. Warranty Limitations

When a claim is made, FURUNO has a right to choose whether to repair the product or replace it.

The FURUNO warranty is only valid if the product was correctly installed and used. Therefore, it is necessary for the customer to comply with the instructions in the handbook. Problems which result from not complying with the instruction manual are not covered by the warranty.

FURUNO is not liable for any damage caused to the vessel by using a FURUNO product.

The following are excluded from this warranty:

- a. Second-hand product
- b. Underwater unit such as transducer and hull unit
- c. Routine maintenance, alignment and calibration services.
- d. Replacement of consumable parts such as fuses, lamps, recording papers, drive belts, cables, protective covers and batteries.
- d. Magnetron and MIC with more than 1000 transmitting hours or older than 12 months, whichever comes first.
- e. Costs associated with the replacement of a transducer (e.g. Crane, docking or diver etc.).
- f. Sea trial, test and evaluation or other demonstrations.
- g. Products repaired or altered by anyone other than the FURUNO national distributor or an authorized dealer.
- h. Products on which the serial number is altered, defaced or removed.
- i. Problems resulting from an accident, negligence, misuse, improper installation, vandalism or water penetration.
- j. Damage resulting from a force majeure or other natural catastrophe or calamity.
- k. Damage from shipping or transit.
- l. Software updates, except when deemed necessary and warrantable by FURUNO.
- m. Overtime, extra labour outside of normal hours such as weekend/holiday, and travel costs above the 160 KM allowance
- n. Operator familiarization and orientation.

FURUNO Electric Company, March 1, 2011

## **FURUNO Warranty for North America**

FURUNO U.S.A., Limited Warranty provides a twenty-four (24) months LABOR and twenty-four (24) months PARTS warranty on products from the date of installation or purchase by the original owner. Products or components that are represented as being waterproof are guaranteed to be waterproof only for, and within the limits, of the warranty period stated above. The warranty start date may not exceed eighteen (18) months from the original date of purchase by dealer from Furuno USA and applies to new equipment installed and operated in accordance with Furuno USA's published instructions.

Magnetrons and Microwave devices will be warranted for a period of 12 months from date of original equipment installation.

Furuno U.S.A., Inc. warrants each new product to be of sound material and workmanship and through its authorized dealer will exchange any parts proven to be defective in material or workmanship under normal use at no charge for a period of 24 months from the date of installation or purchase.

Furuno U.S.A., Inc., through an authorized Furuno dealer will provide labor at no cost to replace defective parts, exclusive of routine maintenance or normal adjustments, for a period of 24 months from installation date provided the work is done by Furuno U.S.A., Inc. or an AUTHORIZED Furuno dealer during normal shop hours and within a radius of 50 miles of the shop location.

A suitable proof of purchase showing date of purchase, or installation certification must be available to Furuno U.S.A., Inc., or its authorized dealer at the time of request for warranty service.

This warranty is valid for installation of products manufactured by Furuno Electric Co. (hereafter FURUNO). Any purchases from brick and mortar or web-based resellers that are imported into other countries by anyone other than a FURUNO certified dealer, agent or subsidiary may not comply with local standards. FURUNO strongly recommends against importing these products from international websites or other resellers, as the imported product may not work correctly and may interfere with other electronic devices. The imported product may also be in breach of the local laws and mandated technical requirements. Products imported into other countries, as described previously, shall not be eligible for local warranty service.

For products purchased outside of your country please contact the national distributor of Furuno products in the country where purchased.

### **WARRANTY REGISTRATION AND INFORMATION**

To register your product for warranty, as well as see the complete warranty guidelines and limitations, please visit [www.furunousa.com](http://www.furunousa.com) and click on "Support". In order to expedite repairs, warranty service on Furuno equipment is provided through its authorized dealer network. If this is not possible or practical, please contact Furuno U.S.A., Inc. to arrange warranty service.

**FURUNO U.S.A., INC.**  
**Attention: Service Coordinator**  
4400 N.W. Pacific Rim Boulevard  
Camas, WA 98607-9408  
Telephone: (360) 834-9300  
FAX: (360) 834-9400

Furuno U.S.A., Inc. is proud to supply you with the highest quality in Marine Electronics. We know you had several choices when making your selection of equipment, and from everyone at Furuno we thank you. Furuno takes great pride in customer service.

## EC Declaration of Conformity



We **FURUNO ELECTRIC CO., LTD.**

(Manufacturer)

9-52 Ashihara-Cho, Nishinomiya City, 662-8580, Hyogo, Japan

(Address)

declare under our sole responsibility that the product

**AUTOPILOT NAVpilot-700, NAVpilot-711 and NAVpilot-720**

(Model name, type number)

to which this declaration relates is in conformity with the following standard(s) or other normative document(s)

IEC 60945: Ed.4.0: 2002, clauses 9.2, 9.3, 10.3, 10.4, 10.5, 10.8 and 10.9

IEC 60945: Ed.3.0: 1996, clauses 10.2 and 10.3

(title and/or number and date of issue of the standard(s) or other normative document(s))

For assessment, see

- EMC Test Report FLI 12-09-065, November 5, 2009 prepared by Furuno Labotech International Co., Ltd.

This declaration is issued according to the Directive 2004/108/EC of the European Parliament and of the Council of 15 December 2004 on the approximation of the laws of the Member States relating to electromagnetic compatibility and repealing Directive 89/336/EEC.

On behalf of Furuno Electric Co., Ltd.

Takahiko Kusuda  
Manager, QMS Secretariat  
Quality Assurance Department

Nishinomiya City, Japan  
May 27, 2010

(Place and date of issue)

(name and signature or equivalent marking of authorized person)