

TSM1330C

13.3” Vessel Monitoring and Control

Touchscreen

User’s Manual

Revision 1.0

Copyright © 2014 Maretron, LLP All Rights Reserved

Maretron, LLP
9014 N. 23rd Ave #10
Phoenix, AZ 85021-7850
<http://www.maretron.com>

Maretron Manual Part #: M003054

Revision History

Rev.	Description
1.0	Original document

Table of Contents

1	General.....	1
1.1	Introduction	1
1.2	Firmware Revision	2
1.3	TSM1330C Features.....	2
1.4	Quick Install.....	2
2	Installation.....	4
2.1	Unpacking the Box	4
2.2	Choosing a Mounting Location.....	4
2.3	Mounting the TSM1330C	5
2.3.1	Mounting Considerations	5
2.3.2	Ergonomics.....	6
2.3.3	Arm Mounting	8
2.4	Connecting the TSM1330C	9
2.4.1	LAN Connection.....	10
2.4.2	USB Device Connection	11
2.4.3	Power Connection.....	12
2.4.4	Grounding Screw	13
2.4.5	NMEA 2000® Connection.....	13
2.5	Power Sequencing	14
2.6	Configuring the TSM1330C.....	14
2.6.1	Manually Entering LAN Connection Information	15
3	Operating the TSM1330C	18
3.1	Turning the TSM1330C On	18
3.2	Turning the TSM1330C Off	18
3.3	Adjusting the Screen Brightness on the TSM1330C	18
3.4	Using the TSM1330C	18
4	Maintenance	19
5	Troubleshooting.....	20
6	Mechanical Drawings.....	21
7	Technical Specifications	22
8	Technical Support.....	24
9	Maretron (1 Year) Limited Warranty.....	25

Table of Figures

Figure 1 – TSM1330C Network Diagram	1
Figure 2 – TSM1330C Cutout Dimensions (units in mm [inches]).....	7
Figure 3 – TSM1330C VESA Arm Mounting Retention Screw Holes.....	8
Figure 4 – TSM1330C Interface Connector Panel	9
Figure 5 – LAN Connection.....	11
Figure 6 – USB Device Connection	12
Figure 7 – Power Connections.....	12
Figure 8 – Attaching Power Cables to Connector	13
Figure 9 – TSM1330C Startup Screen.....	15
Figure 10 – N2KView [®] Window with Tabs Displayed.....	16
Figure 11 – Configuration Dialog	17
Figure 12 – N2KView [®] Window with Tabs Displayed.....	17
Figure 13 – Connections Settings Dialog.....	17

1 General

1.1 Introduction

Congratulations on your purchase of the Maretron TSM1330C Vessel Monitoring and Control Touchscreen. Maretron has designed and built your display to the highest standards for years of dependable and accurate service.

The TSM1330C is an 13.3" dedicated touchscreen that includes Maretron's N2KView[®] vessel monitoring and control software. The N2KView[®] software allows you to configure as many favorite screens as you want with exactly the information you want to see. The TSM1330C provides an extremely simple touch interface for monitoring and controlling critical systems from anywhere on the vessel.

The TSM1330C is ruggedized for marine use and includes a solid state disk drive to withstand the pounding associated with waves. And since the TSM1330C only dissipates 20 watts, there is no need for internal cooling fans that are noisy and wear out causing electronics to overheat and fail. The TSM1330C can be mounted outside given the high bright screen and waterproof front.

As an alternative to controlling the TSM1330C through the touch screen, the TSM1330C includes two USB ports for connecting keyboards, mice, or trackballs. The TSM1330C also has an Ethernet port for connecting Internet Protocol (IP) cameras for viewing within the N2KView[®] software. Lastly, the TSM1330C contains two completely isolated CAN bus connectors (M12) for easy connection to single or redundant NMEA 2000[®] networks.

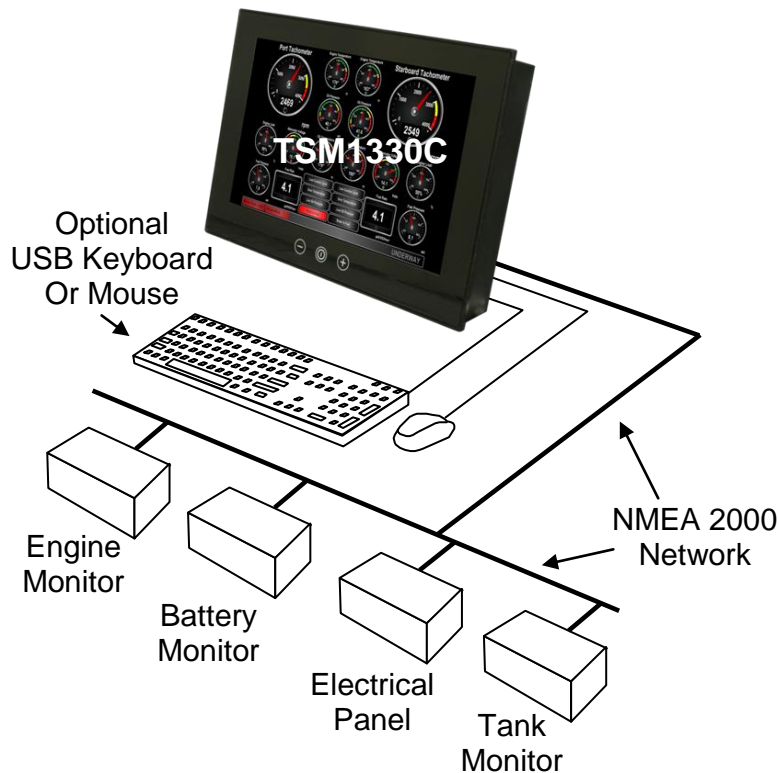

The Maretron TSM1330C is designed to operate in the harsh conditions of the marine environment. However, no piece of marine electronic equipment can function properly unless installed, configured, and maintained in the correct manner. Please read carefully and follow these

instructions for installation, configuration, and usage of the Maretron TSM1330C in order to ensure optimal performance.

1.2 Firmware Revision

This manual corresponds to the TSM1330C running N2KView® Version 4.0.2.

1.3 TSM1330C Features

NOTE

Although the TSM1330C looks similar to the former TSM1330 product, there are important differences. The TSM1330C is a standalone NMEA 2000® display, with the following features:

- The TSM1330C includes two CAN interfaces for direct connection to one or two NMEA 2000® networks.
- The TSM1330C includes all N2KView® capabilities that were formerly licensed separately in the TSM1330: Alerts, Control, Fuel Management, and Video. No gateways (such as the IPG100), hardware license keys, or additional software licenses are needed.
- You don't need to connect or configure LAN connections, unless you are using Video or E-mail alert actions.
- N2KView® configurations are transferred to and from other N2KView® devices using a USB flash drive plugged into one of the TSM1330C's USB ports.



The Maretron TSM1330C has the following features:

- 13.3" TFT LCD Panel, LED Backlit
- Widescreen Aspect Ratio 16:9
- 1280 x 800 Pixels
- 400 nits Brightness (Optically Bonded)
- Solid State Disk Drive
- Fanless Cooling System
- Flush mounting hardware included
- Optional VESA mounting capability
- All N2KView licenses included
- 2 isolated NMEA 2000® connectors for direct connection to single or dual NMEA 2000® networks

1.4 Quick Install

Installing the Maretron TSM1330C display involves the following five steps. Please refer to the individual sections for additional details.

- Unpacking the Box (Section 2.1)
- Choosing a Mounting Location (Section 2.2)
- Mounting the TSM1330C (Section 2.3)
- Connecting the TSM1330C (Section 2.4)
- Configuring the TSM1330C (Section 2.6)

2 Installation

2.1 Unpacking the Box

When unpacking the box containing the Maretron TSM1330C, you should find the following items:

- 1 – TSM1330C 13.3" Vessel Monitoring and Control Touchscreen
- 1 – TSM1330C User's Manual
- 1 – N2KView® Documentation CD-ROM
- 1 – 1m USB Cable with Waterproof Bulkhead Connector
- 1 – Warranty Registration Card

If any of these items are missing or damaged, please contact Maretron.



NOTE

To prevent damage to chassis corners and/or breaking front glass, please review the illustrations below before handling the TSM1330C.

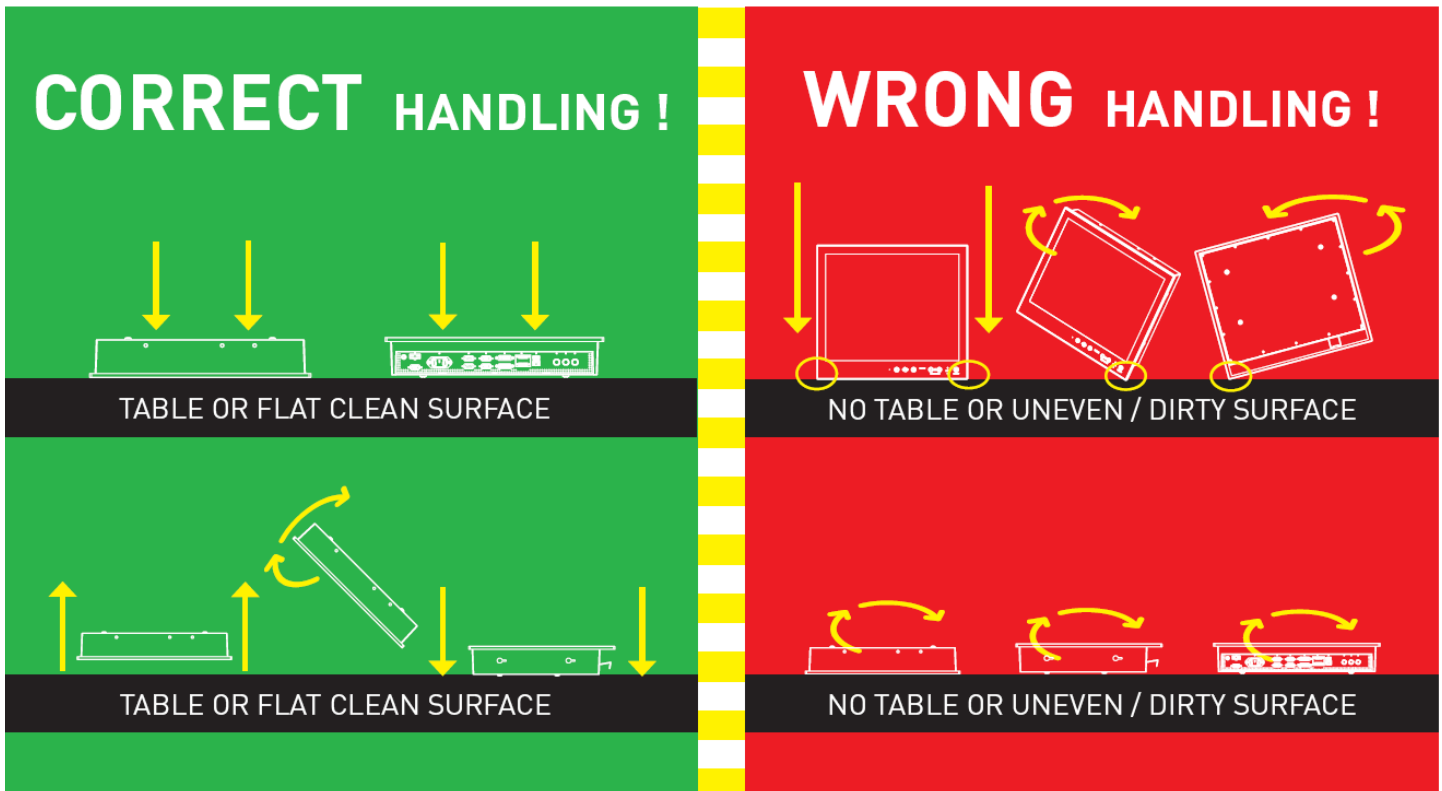

2.2 Choosing a Mounting Location

The TSM1330C front panel is splash proof (IEC IP66 rating – protected against the effects of powerful water jets), while the rear of the TSM1330C is drip proof (IEC IP22 rating – protected

against the effects of dripping water when tilted up to 15°). The TSM1330C may be mounted either in an indoor or outdoor location.

Adequate ventilation is a necessary prerequisite for the life of the product. The air inlet and outlet openings must definitely be kept clear; coverings which restrict ventilation are not permissible.

Generally, do not install the unit in a horizontal position (laying down), as this will cause heat to build up inside the unit which will damage the LCD Panel. To prevent this problem, we recommend installing the unit in a vertical position (± 30 degrees) to improve the airflow through the unit.

To further improve the cooling of the unit, we recommend installing Cooling Fans underneath blowing upwards into the unit air inlet. This may be required in high temperature applications and also when there is reason to expect temperature problems due to non-optimal way of mounting.

Exposure to extreme direct sunlight can cause a considerable increase in the temperature of the unit, and might under certain circumstances lead to overtemperature. This point should already be taken into consideration when the bridge equipment is being planned (sun shades, distance from the windows, ventilation, etc.).

Space necessary for ventilation, for cable inlets, for the operating procedures and for maintenance, must be provided.

Proper strain relieve should be installed on cables attached to the TSM1330C so that cable breaks will not occur, e.g. during service work.

Do not paint the product. The surface treatment influences on the excess heat transfer. Painting, labels or other surface treatments that differ from the factory default, might cause overheating.

Expose to heavy vibration and acoustic noise might under certain circumstances affect functionality and expected lifetime. This must be considered during system assembly and installation. Mounting position must carefully be selected to avoid any exposure of amplified vibration.

2.3 Mounting the TSM1330C

The TSM1330C has two mounting options, which include:

- Wall/Panel mounting
- Arm mounting (requires purchase of a VESA 75mm mounting arm)

2.3.1 Mounting Considerations

The useful life of the components of all Electronics Units generally decreases with increasing ambient temperature; it is therefore advisable to install such units in air-conditioned rooms. If there are no such facilities, these rooms must at least be dry, adequately ventilated and kept at a suitable temperature in order to prevent the formation of condensation inside the display unit.

Since the TSM1330C is fanless, cooling takes place via the surface of the casing. The cooling must not be impaired by partial covering of the unit or by installation of the unit in a confined cabinet.

In the area of the wheel house, the distance of each electronics unit from the magnetic standard compass or the magnetic steering compass must not be less than the permitted magnetic protection distance. This distance is measured from the centre of the magnetic system of the compass to the nearest point on the corresponding unit concerned.

Units which are to be used on the bridge wing must be installed inside the “wing control console” protected against the weather. In order to avoid misting of the viewing screen, a 25 ... 50 W console-heating (power depending on the volume) is recommended.

When selecting the site of a display unit, the maximum cable lengths have to be considered.

When a product is being installed, the surface base or bulkhead must be checked to ensure that it is flat in order to avoid twisting of the unit when the fixing screws are tightened, because such twisting would impair mechanical functions. Any unevenness should be compensated for by means of spacing-washers.

The grounding screws of the units must be connected to the body of the ship (ground); the wire used should have a cross sectional area of at least 6 mm².

Transportation damage, even if apparently insignificant at first glance, must immediately be examined and be reported to the freight carrier. The moment of setting-to-work of the equipment is too late, not only for reporting the damage but also for the supply of replacements.

The classification is only valid for approved mounting brackets provided by Maretron. The unit shall be mounted stand-alone without any devices or loose parts placed at or nearby the unit. Any other type of mounting might require test and re-classification.

2.3.2 Ergonomics

Adjust the unit height so that the top of the screen is at or below eye level. Your eyes should look slightly downwards when viewing the middle of the screen.

Adjust screen inclination to remain gaze angle to the centre of the screen approximately perpendicular to the line of gaze.

When products are to be operated both from a sitting position and from a standing position, a screen inclination of about 30° to 40° (from a vertical plane) has turned out to be favorable.

The brightness of displays is limited. Sunlight passing directly through the bridge windows - or its reflection – which falls upon the screen workplaces must be reduced by suitable means (negatively inclined window surfaces, venetian blinds, distance from the windows, dark coloring of the deckhead). These units are equipped with optical enhanced technology to reduce reflections and are viewable in direct sun light, but as a general rule the units at the bridge wing area is recommended to be installed or mounted by suitable alignment or bulkhead /deckhead mounting in such a way that reflections of light from the front panel of the display are not directed into the observer’s viewing direction.

The use of ordinary commercial filter plates or filter films is not permitted for items of equipment that require approval (by optical effects, “aids” of that kind can suppress small indicators, for example).

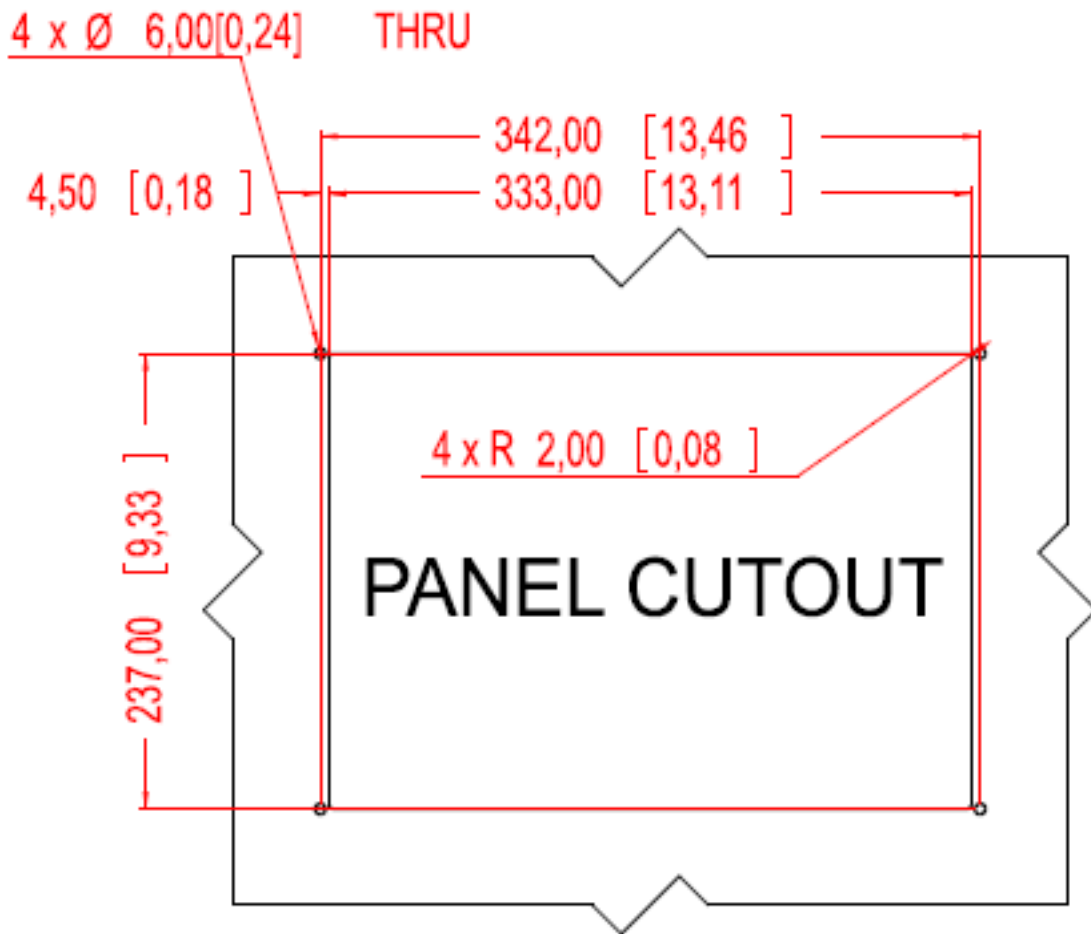

Figure 2 – TSM1330C Cutout Dimensions (units in mm [inches])

Step 1: Select the position on the panel or wall to mount the TSM1330C.

Step 2: Cut out a section from the panel that corresponds to the rear panel dimensions of the TSM1330C. Take care that the panel section that is cut out is smaller than the overall size of the front panel of the TSM1330C but just large enough for the rear panel of the TSM1330C to fit through, according to the dimensions in Figure 2 above.

Step 3: Drill four 6mm holes for the M5 studs protruding from the four corners of the front panel according to the dimensions in Figure 2 above.

Step 4: Slide the TSM1330C through the hole until the frame is flush against the panel.

Step 5: From behind the panel, screw the four supplied mounting nuts onto the M5 studs protruding from the rear of the frame, and tighten until the display is firmly secured to the panel.

2.3.3 Arm Mounting

The TSM1330C is VESA (Video Electronics Standards Association) compliant and can be mounted on an arm with a 75mm interface pad. To mount the TSM1330C on an arm, please follow the steps below.



NOTE

When purchasing a mounting arm please ensure that it is VESA compliant and that the arm has a 75 mm interface pad. If it is not VESA compliant, it cannot be used to support the TSM1330C.

- Step 1:** Please correctly mount the arm onto the base surface. To do this, refer to the installation documentation that came with the mounting arm.
- Step 2:** Once the mounting arm has been firmly attached to the base surface, lift the TSM1330C onto the interface pad of the mounting arm.
- Step 3:** Align the retention screw holes on the mounting arm interface with those in the TSM1330C. The arm mount retention screw holes are shown in Figure 3.
- Step 4:** Secure the TSM1330C to the interface pad by inserting the retention screws through the bottom of the mounting arm interface pad and into the TSM1330C.

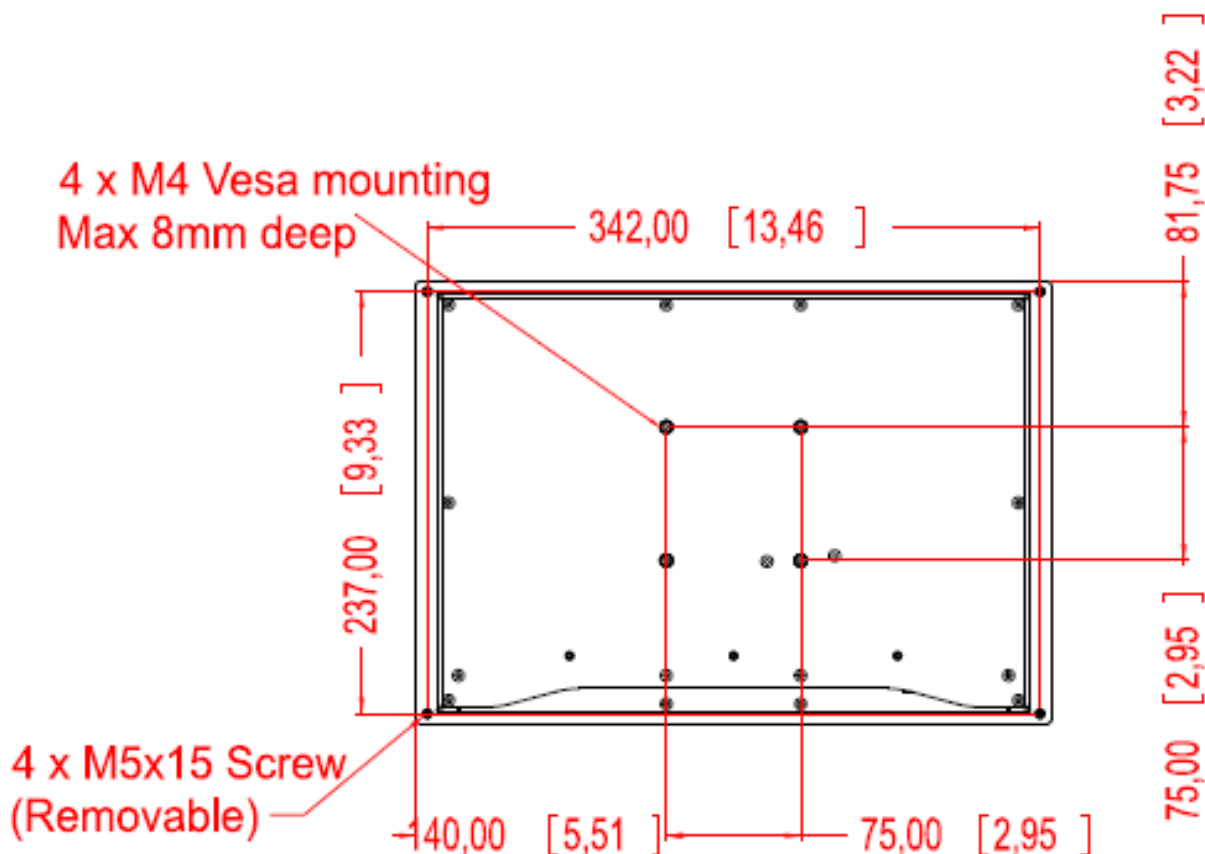

Figure 3 – TSM1330C VESA Arm Mounting Retention Screw Holes

2.4 Connecting the TSM1330C

Most I/O interface connections of the TSM1330C are found on the bottom panel. The I/O interface panel located on the bottom of the TSM1330C has the following I/O interface connectors:

- 2 x 24V DC Power input connector
- 1 x RJ-45 Gigabit Ethernet LAN port
- 2 x USB 2.0 connectors
- 1 x Grounding Screw

The bottom panel of the TSM1330C is shown in Figure 4.

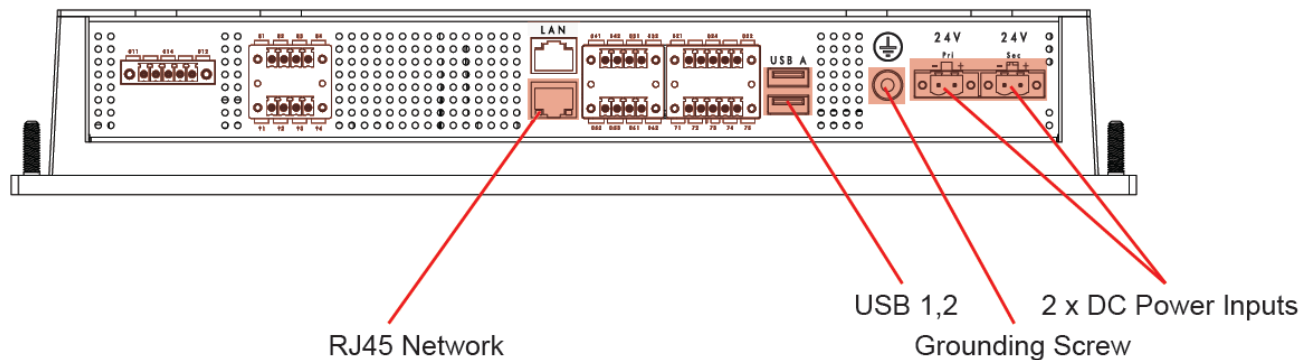

Figure 4 – TSM1330C Bottom Panel

Additionally, the rear panel of the TSM1330C has the following interface connectors:

- 2 x M12 (DeviceNet Micro) NMEA 2000 ® network CAN connectors

The rear panel of the device is shown in **Error! Reference source not found.** below.

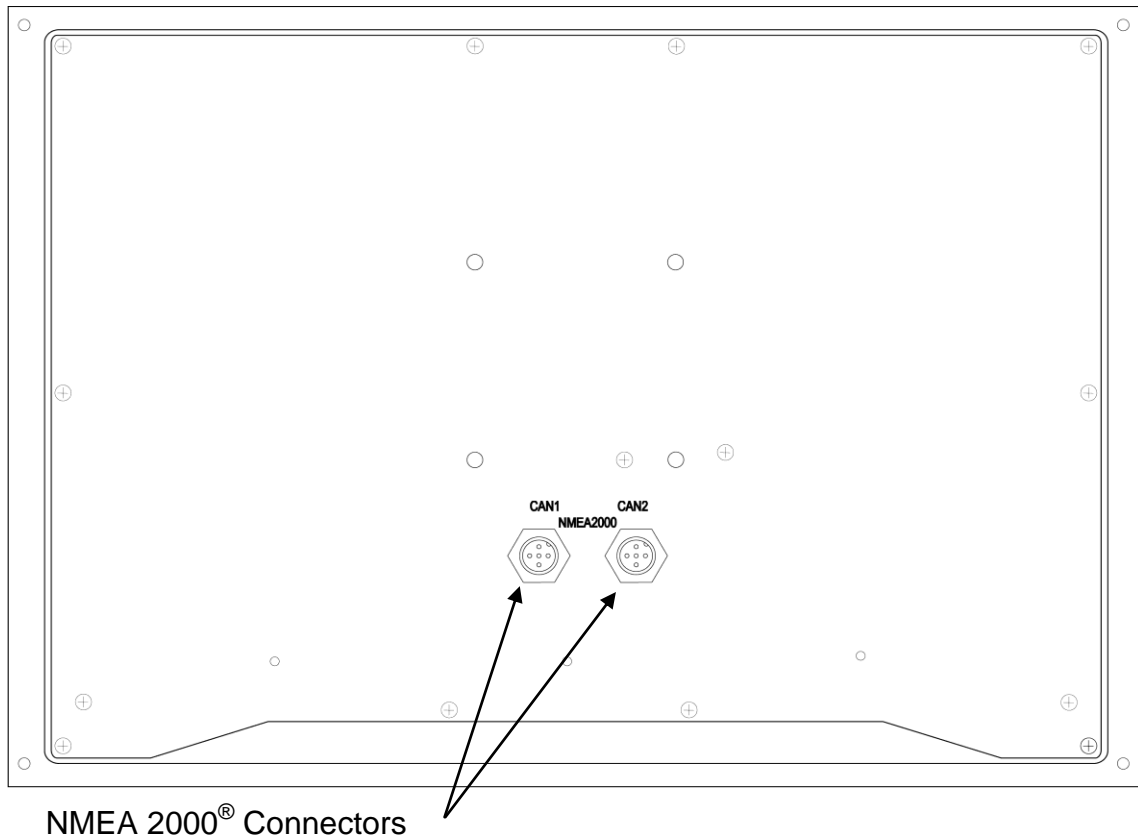

Figure 5 - TSM1330C Rear Panel

2.4.1 LAN Connection

There is one external RJ-45 LAN connector (a second RJ-45 connector is plugged at the factory and should not be used). The RJ-45 connector enables connection to an external network. To connect a LAN cable with an RJ-45 connector, please follow the instructions below.

Step 1: Locate an RJ-45 connector on the bottom panel of the TSM1330C.

Step 2: Align the connector. Align the RJ-45 connector on the LAN cable with the RJ-45 connector on the bottom panel of the TSM1330C. See Figure 6.

Step 3: Insert the LAN cable RJ-45 connector. Once aligned, gently insert the LAN cable RJ-45 connector into the onboard RJ-45 connector.

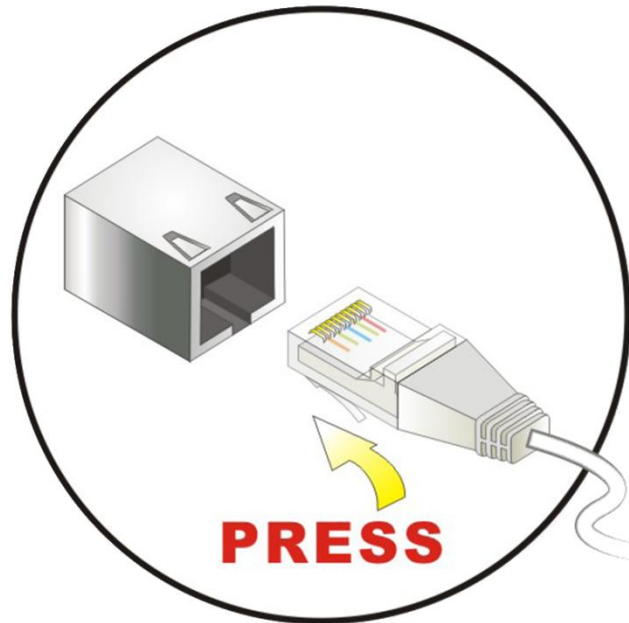

Figure 6 – LAN Connection

2.4.2 USB Device Connection

There are two external USB 2.0 connectors. The USB connectors are used to transfer N2KView[®] configurations between the TSM1330C and other N2KView[®] devices, and also for applying software updates to the TSM1330C. Install the included waterproof USB bulkhead connector in a position where it is easily accessible and plug into one of the USB connectors on the TSM1330C per the instructions below. This will make the USB connection easily accessible once the TSM1330C is installed.

The USB connectors may optionally be used to install USB keyboards or USB mice for an alternative means of controlling the TSM1330C user interface.

To connect a USB 2.0 or USB 1.1 device, please follow the instructions below.

Step 1: Locate the USB connectors. The locations of the USB connectors are shown in Figure 4.

Step 2: Align the connectors. Align the USB device connector with one of the connectors on the bottom panel. See Figure 7.

Step 3: Insert the device connector. Once aligned, gently insert the USB device connector into the onboard connector.

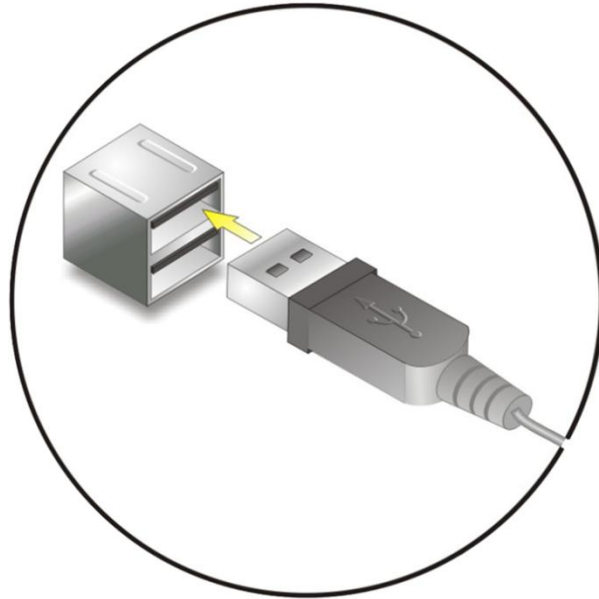

Figure 7 – USB Device Connection

2.4.3 Power Connection

The TSM1330C must be connected to a power source (over current protection should be provided and should be sized in accordance with ABYC E-11, AC and DC ELECTRICAL SYSTEMS ON BOATS). The TSM1330C provides two sets of independent, galvanically isolated power connections and can run off the power supplied by either connection, allowing for redundant power connection.

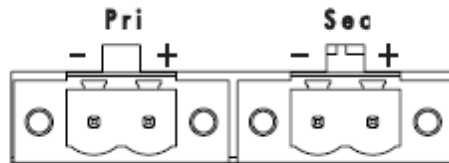

Figure 8 – Power Connections

Connect your DC power cables to the SL-SMT 09F connector block as follows:

- Step 1:** Unscrew (from top) or make sure that the screw terminals (square area) are fully open, so you can secure the inserted cables correctly to the loose housing connector (it may already be plugged into the unit as per factory installation).
- Step 2:** Insert cables (from front) and screw / secure the cables by turning the screw on top of the housing to secure the cables properly. Check that the cables are firmly in place and do not appear loose or fall out when pulling gently.



NOTE

Required polarization verification (for instance -/+ for DC power input) should conform to the markings on the connector area of the unit. Ignoring the markings on the unit or its add-on modules might damage the unit and/or external equipment in which end, warranty will be void.

Step 3: Plug the housing into the appropriate connector area of the unit and check again that the cables secured conforms to the markings on the connector area of the unit.

Step 4: Finalize the installation by fasten the screws located in front on each side of the housing connector.

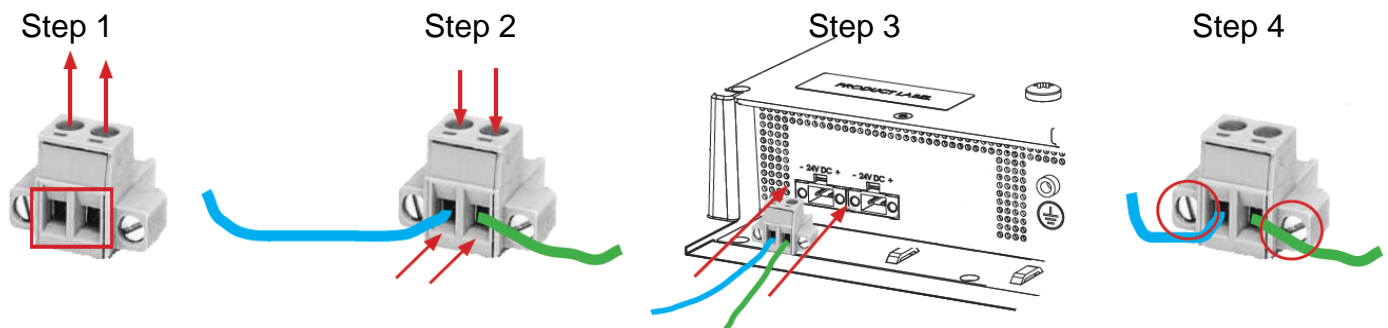

Figure 9 – Attaching Power Cables to Connector

2.4.4 Grounding Screw

The TSM1330C is required to be properly grounded via the grounding screw located on the bottom of the unit.

2.4.5 NMEA 2000[®] Connection

The two NMEA 2000[®] connectors can be found on the rear panel of the TSM1330C. If you are using a single NMEA 2000[®] network, connect either of the connectors to the NMEA 2000[®] network. If you are using dual NMEA 2000[®] networks, connect each NMEA 2000[®] connector to one of the NMEA 2000[®] networks. Note that if you are using dual NMEA 2000[®] networks, the instancing of device and data instance on the network nodes must be unique across both networks. For example, if one network has a device which transmits fluid level data for Fuel Tank instance 0, the other network must not contain a device which transmits fluid level data for Fuel Tank instance 0.

The NMEA 2000[®] connectors are round five pin male connectors (see Figure 10). You connect the TSM1330C to an NMEA 2000[®] network using a Maretron NMEA 2000[®] cable (or an NMEA 2000[®] compatible cable) by connecting the female end of the cable to the TSM1330C (note the key on the male connector and keyway on the female connector). Be sure the cable is connected securely and that the collar on the cable connector is tightened firmly. Connect the other end of the cable (male) to the NMEA 2000[®] network in the same manner. The TSM1330C is designed such that you can plug or unplug it from an NMEA 2000[®] network while the power to the network is connected or disconnected. Please follow recommended practices for installing NMEA 2000[®] network products.

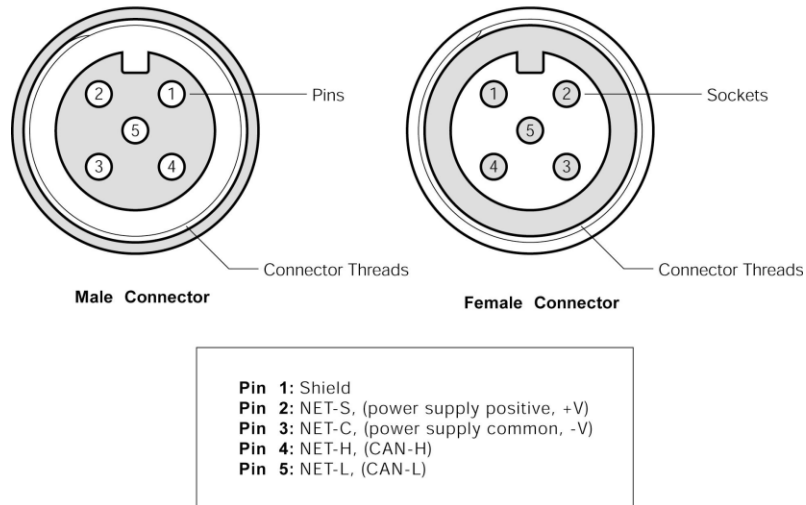

Figure 10 – NMEA 2000[®] Connector Face Views

2.5 Power Sequencing

When the TSM1330C is connected to an appropriate power source, you can use the power switch located on the front panel to turn the TSM1330C on or off. If the TSM1330C is turned on, then the switches found on the front panel will be illuminated. If the power switch is pushed to power down the TSM1330C, the front panel switches will be dark.

The TSM1330C can also be switched on and off by applying or removing power through an external switch or breaker. Anytime the power is reapplied to the TSM1330C, it will turn on.

The red LED on the front panel will illuminate anytime power is supplied to the TSM1330C.

2.6 Configuring the TSM1330C

In order to use the TSM1330C, you must already have N2KServer[®] installed and running on either a Windows PC or on a Maretron IPG100 Internet Protocol Gateway.

You must also have some information as to the configuration of your local area network.

The TSM1330C will start up with the following warning screen:

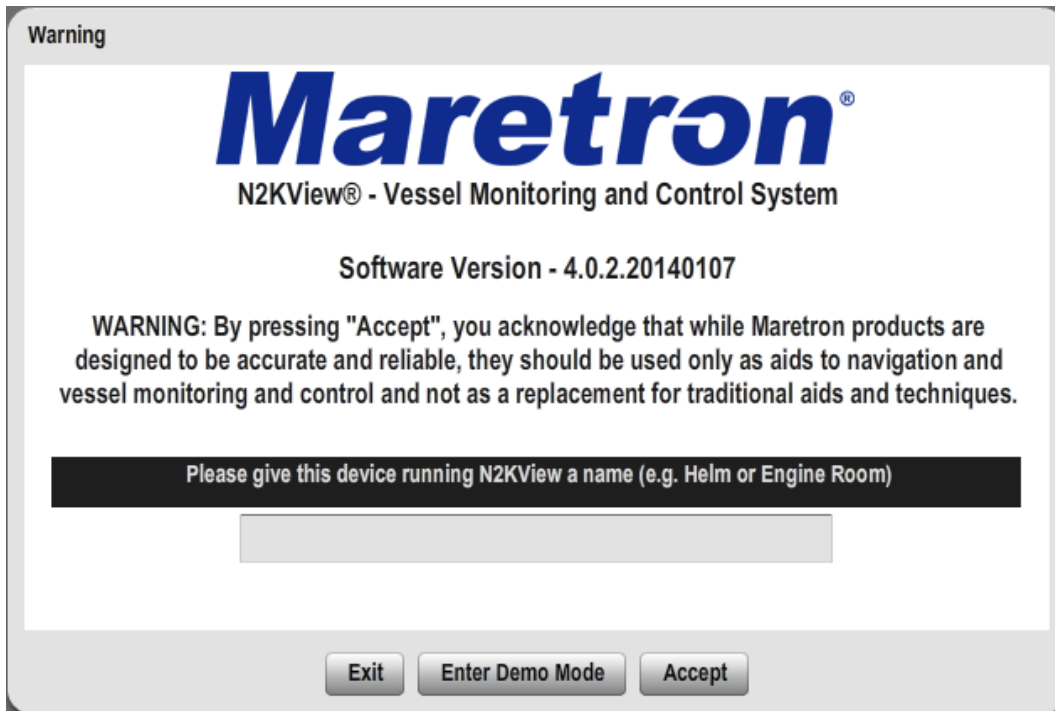

Figure 11 – TSM1330C Startup Screen

The first time you start the TSM1330C, N2KView® will ask you to assign it a unique name. Assigning a unique name to the TSM1330C is necessary in order to help you determine the source of alerts generated by a TSM1330C or other Maretron device capable of generating alerts.

You are required to press **Accept** and thereby acknowledge this warning message before N2KView® will run in Live Mode.

Alternatively, you may **Enter Demo Mode**. In Demo Mode, you will not be able to connect to an NMEA 2000® network and view live data; instead, simulated data will be provided to stimulate the controls.

Finally, you may choose **Exit**, in which case the TSM1330C will power off.

2.6.1 Manually Entering LAN Connection Information



NOTE

The LAN Connection is not necessary unless you are using any of the following features:

- Video
- E-mail actions on Alerts

If you intend to use the Video feature or send e-mails via the Alerts feature, you must ensure that the device can connect to your LAN (local area network). The TSM1330C comes from the factory

TSM1330C User's Manual

preconfigured to obtain its LAN connection information from a DHCP (Dynamic Host Control Protocol) server. If your local area network uses a DHCP server, no configuration is necessary, and the TSM1330C should be able to successfully connect to the local area network.

If your local area network does not use DHCP, you must manually enter the LAN connection information into the TSM1330C. This is done through the following steps:



Figure 12 – N2KView® Window with Tabs Displayed

- Click anywhere inside the N2KView® screen to display the screen tabs as shown in Figure 12 above.
- Click on the “**Commands & Settings**” tab on the right side of the N2KView® screen to display the Configuration dialog.
- Click on the “**Configuration**” button in the Commands & Settings window to display the Configuration dialog.
- Click on the “**Network Configuration**” tab in the Configuration dialog to display the Network Configuration dialog.

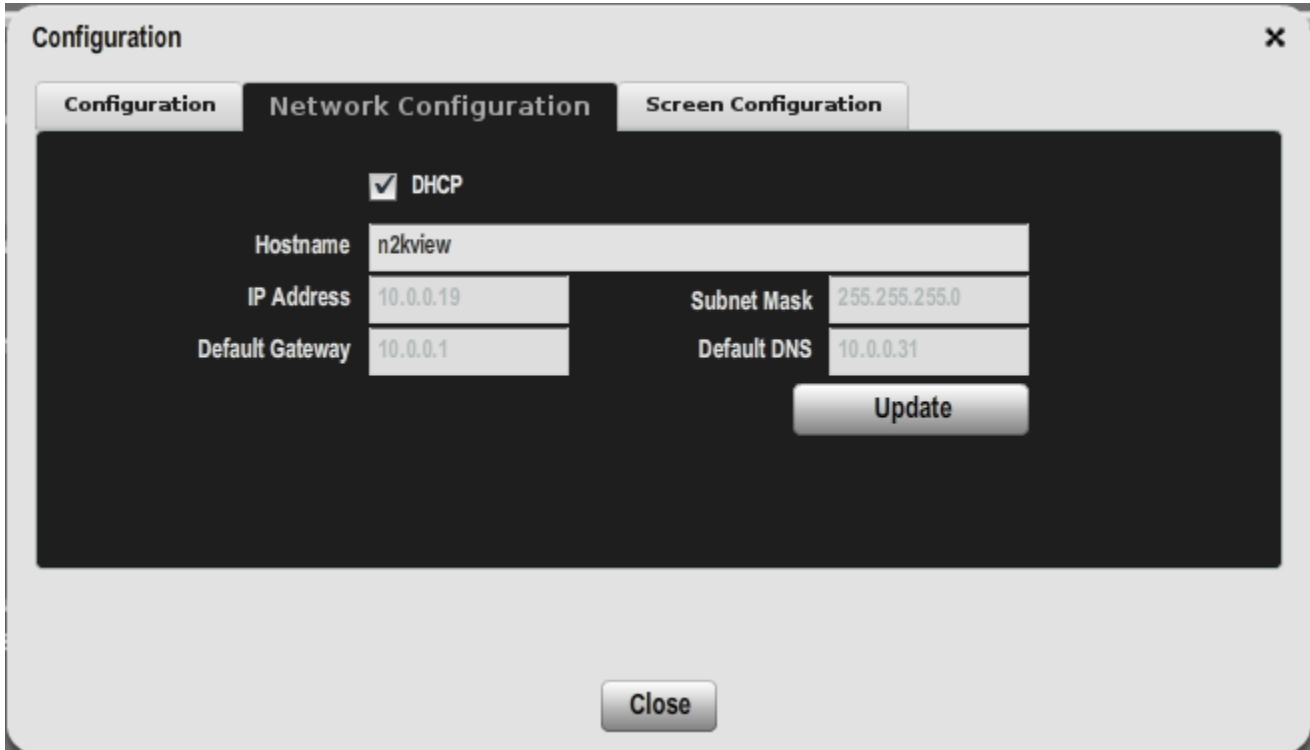

Figure 13 – Configuration Dialog, Network Tab

- e. Uncheck the “**Use DHCP**” box to indicate that your LAN does not use DHCP.
- f. Optionally, in the “Hostname” field, enter a hostname for the TSM1330C. This is used by the network router.
- g. In the “**IP Address**” field, enter the IP address you wish to assign to the TSM1330C.
- h. In the “**Subnet Mask**” field, enter the netmask value used on your LAN (in most cases, this value will be “255.255.255.0”).
- i. In the “Default **Gateway**” field, enter the IP address of the default gateway of your LAN.
- j. In the “**Default DNS**” field, enter the IP address of a DNS (Dynamic Name Service) Server used on your LAN.
- k. Click the “**Update**” button to make these changes permanent. The screen will go blank for a few seconds while this is being done.

3 Operating the TSM1330C

3.1 Turning the TSM1330C On

To turn on the TSM1330C, press the power button, located underneath the screen on the front of the TSM1330C for at least one second. The power button backlights will change from dim to bright once the power-on process begins.

3.2 Turning the TSM1330C Off

To turn the TSM1330C off, use the “Shutdown” administrative tab of the N2KView[®] software. Alternatively, you can power down the unit by pressing the power button, located underneath the screen on the front of the TSM1330C for at least one second. The power button backlights will change from bright to dim once the power-off process begins.

3.3 Adjusting the Screen Brightness on the TSM1330C

Touch the illuminated (-) or (+) symbols underneath the screen to adjust the brilliance/brightness of the displayed image.

3.4 Using the TSM1330C

The TSM1330C runs a fully functional version of the Maretron N2KView[®] software. Please refer to the *N2KView[®] User's Manual*, included with the TSM1330C, for detailed operating instructions.

4 Maintenance

Regular maintenance is important to ensure continued proper operation of the Maretron TSM1330C. Perform the following tasks periodically:

- Clean the unit with a soft cloth. Do not use chemical cleaners as they may remove paint or markings or may corrode the TSM1330C enclosure or seals. Do not use any cleaners containing acetone, as they will deteriorate the plastic enclosure. Do not spray cleaning liquids directly onto the TSM1330C.
- Ensure that the unit is mounted securely and cannot be moved relative to the mounting surface. If the unit is loose, tighten the mounting screws.
- Check the security of the power and network cables connected to the TSM1330C and tighten if necessary.

5 Troubleshooting

If you notice unexpected operation of the Maretron TSM1330C, follow the troubleshooting procedures in this section to remedy simple problems.

Symptom	Troubleshooting Procedure
No activity on the display	Check the connection to the power and network connectors and tighten if necessary Ensure that power is supplied to the connected power cable. Press the power switch located on the underside of the device on the right-hand side of the unit behind the LCD screen. Check that the NMEA 2000 [®] interfaces are correctly connected to the NMEA 2000 [®] network.
Other Issues	Please refer to the Troubleshooting section of the <i>N2KView[®] User's Manual</i> .

If these steps do not solve your problem, please contact Maretron Technical Support (refer to Section 8 for contact information).

Warning: There are no user-serviceable components inside the Maretron TSM1330C. Opening the TSM1330C will expose the sensitive electronic components to adverse environmental conditions that may render the unit inoperative. Please do not open the TSM1330C, as this will automatically void the warranty. If service is required, please return the unit to an authorized Maretron service location.

6 Mechanical Drawings

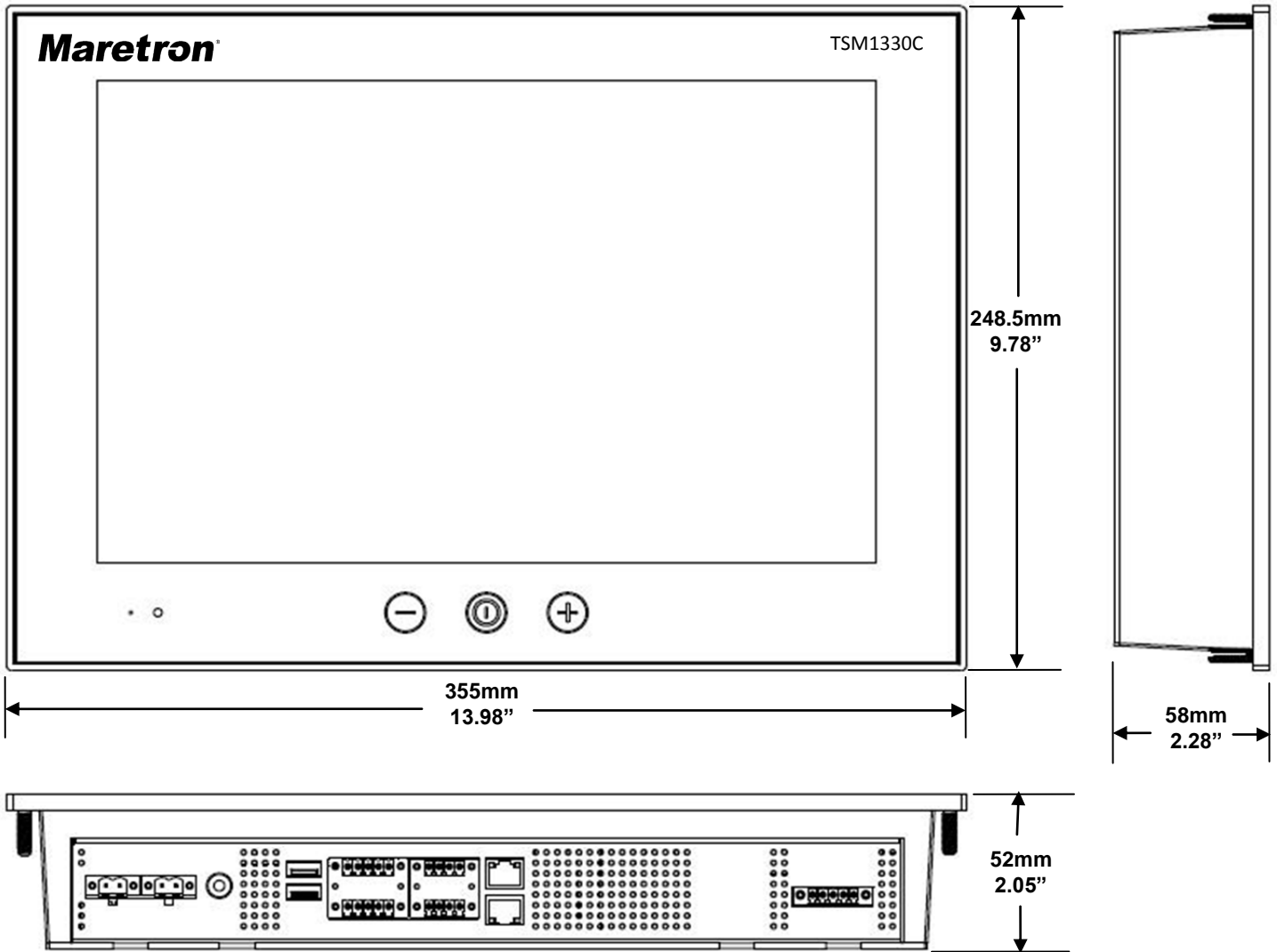

7 Technical Specifications

Specifications

Parameter	Value	Comment
Display Size	13.3"	CCFL Backlit LCD with Projected Capacitive Touch Screen
Display Resolution	1280x800	WXGA
Display Brightness	400cd/m ²	Optically Bonded
Contrast Ratio	800:1	
LCD Color	262K	
Viewing Angle	70° H, 60° V	
Buzzer	85dB	
USB Ports	Two USB 2.0	
Ethernet Ports	One RJ-45 GbE	For connection to Maretron IPG100 or router
Compass Safe Distance	45cm	Standard
	25cm	Steering

Approvals

Parameter	Comment
IEC 60945	
GL – Germanischer Lloyd	
BV –Bureau Veritas	
IACS E10	
DNV - Det Norske Veritas	
LRS – Lloyd's Register of Shipping	Pending
ClassNK – Nippon Kaiji Kyoaki	
ABS – American Bureau of Shipping	

Electrical

Parameter	Value	Comment
Operating Voltage (Dedicated Supply Connection)	18-32 Volts	DC Voltage, Dual Inputs
Power Consumption (Dedicated Supply Connection)	20 Watts	Typical
	30 Watts	Maximum
Operating Voltage (NMEA 2000 [®] Connection)	8-32 Volts	DC Voltage
Power Consumption (NMEA 2000 [®] Connection)	50mA	
Load Equivalence Number (LEN)	1	NMEA 2000 [®] Spec. (1 LEN = 50 mA)
Reverse Battery Protection (NMEA 2000 [®] Connection)	Yes	Indefinitely
Load Dump Protection (NMEA 2000 [®] Connection)	Yes	Energy Rated Per SAE J1113

Mechanical

Parameter	Value	Comment
Overall Dimensions (DxWxH)	2.28" x 13.98" x 9.78" (58mm x 355mm x 248.5mm)	
Weight	9.7 lbs (4.4kg)	
Front Panel Material	Glass	
Front Panel Controls	Power, Brightness +/-	
Mounting	4 x M4 VESA Mounting 75mm x 75mm	Max 8mm deep
	Built-in Console Mounting	4 x M5 x 15mm screws

Environmental

Parameter	Value
Operating Temperature	-15°C to 55°C (Humidity up to 95%)
Storage Temperature	-20°C to 60°C (Humidity up to 95%)
IP Rating	IP66 Front, IP22 Rear (EN60529)

8 Technical Support

If you require technical support for Maretron products, you can reach us in any of the following ways:

Telephone: 1-866-550-9100
Fax: 1-602-861-1777
E-mail: support@maretron.com
World Wide Web: <http://www.maretron.com>
Mail: Maretron, LLP
Attn: Technical Support
9014 N. 23rd Ave Suite 10
Phoenix, AZ 85021 USA

9 Maretron (1 Year) Limited Warranty

Maretron warrants the TSM1330C to be free from defects in materials and workmanship for one (1) year from the date of original purchase. If within the applicable period any such products shall be proved to Maretron's satisfaction to fail to meet the above limited warranty, such products shall be repaired or replaced at Maretron's option. Purchaser's exclusive remedy and Maretron's sole obligation hereunder, provided product is returned pursuant to the return requirements below, shall be limited to the repair or replacement, at Maretron's option, of any product not meeting the above limited warranty and which is returned to Maretron; or if Maretron is unable to deliver a replacement that is free from defects in materials or workmanship, Purchaser's payment for such product will be refunded. Maretron assumes no liability whatsoever for expenses of removing any defective product or part or for installing the repaired product or part or a replacement therefore or for any loss or damage to equipment in connection with which Maretron's products or parts shall be used. With respect to products not manufactured by Maretron, Maretron's warranty obligation shall in all respects conform to and be limited to the warranty actually extended to Maretron by its supplier. The foregoing warranties shall not apply with respect to products subjected to negligence, misuse, misapplication, accident, damages by circumstances beyond Maretron's control, to improper installation, operation, maintenance, or storage, or to other than normal use or service.

THE FOREGOING WARRANTIES ARE EXPRESSLY IN LIEU OF AND EXCLUDES ALL OTHER EXPRESS OR IMPLIED WARRANTIES, INCLUDING BUT NOT LIMITED TO THE IMPLIED WARRANTIES OF MERCHANTABILITY AND OF FITNESS FOR A PARTICULAR PURPOSE.

Statements made by any person, including representatives of Maretron, which are inconsistent or in conflict with the terms of this Limited Warranty, shall not be binding upon Maretron unless reduced to writing and approved by an officer of Maretron.

IN NO CASE WILL MARETRON BE LIABLE FOR INCIDENTAL OR CONSEQUENTIAL DAMAGES, DAMAGES FOR LOSS OF USE, LOSS OF ANTICIPATED PROFITS OR SAVINGS, OR ANY OTHER LOSS INCURRED BECAUSE OF INTERRUPTION OF SERVICE. IN NO EVENT SHALL MARETRON'S AGGREGATE LIABILITY EXCEED THE PURCHASE PRICE OF THE PRODUCT(S) INVOLVED. MARETRON SHALL NOT BE SUBJECT TO ANY OTHER OBLIGATIONS OR LIABILITIES, WHETHER ARISING OUT OF BREACH OF CONTRACT OR WARRANTY, TORT (INCLUDING NEGLIGENCE), OR OTHER THEORIES OF LAW WITH RESPECT TO PRODUCTS SOLD OR SERVICES RENDERED BY MARETRON, OR ANY UNDERTAKINGS, ACTS OR OMISSIONS RELATING THERETO.

Maretron does not warrant that the functions contained in any software programs or products will meet purchaser's requirements or that the operation of the software programs or products will be uninterrupted or error free. Purchaser assumes responsibility for the selection of the software programs or products to achieve the intended results, and for the installation, use and results obtained from said programs or products. No specifications, samples, descriptions, or illustrations provided Maretron to Purchaser, whether directly, in trade literature, brochures or other documentation shall be construed as warranties of any kind, and any failure to conform with such specifications, samples, descriptions, or illustrations shall not constitute any breach of Maretron's limited warranty.

TSM1330C User's Manual

Warranty Return Procedure:

To apply for warranty claims, contact Maretron or one of its dealers to describe the problem and determine the appropriate course of action. If a return is necessary, place the product in its original packaging together with proof of purchase and send to an Authorized Maretron Service Location. You are responsible for all shipping and insurance charges. Maretron will return the replaced or repaired product with all shipping and handling prepaid except for requests requiring expedited shipping (i.e. overnight shipments). Failure to follow this warranty return procedure could result in the product's warranty becoming null and void.

Maretron reserves the right to modify or replace, at its sole discretion, without prior notification, the warranty listed above. To obtain a copy of the then current warranty policy, please go to the following web page:

<http://www.maretron.com/company/warranty.php>