



VHF + UHF Amplified HDTV Antenna

Model OA8000 & OA8001 Installation Instructions

Reception Frequencies	Voltage
VHF: 47-230 MHz	Input: AC110-120V / AC220-240V
UHF: 470-860 MHz	Working: DC12V / 100mA

STEP 1: Verify all components and parts are included.

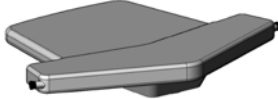

KING Jack Antenna Head



Power Injector



RV Antenna Bracket



Pole Mount Bracket

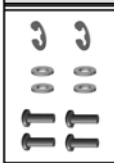

(2) Retaining Clips
(4) Lock Washers
(4) Screws



Power Supply



Dielectric Grease Packet

The rubber boot may be installed over coax connection to provide extra protection from the elements.

If your coax connection is damaged, use replacement connection provided.

INSTALLATION REQUIRES PROPER TOOLS. SEE YOUR DEALER FOR ASSISTANCE.



Coax Connection



Cut boot to install over coax connection.

Rubber Boot

STEP 2: Install the KING Jack Antenna in one of two ways (Page 2):

- **RV Mounting:** Mount to a bat wing style retractable arm using the supplied RV Antenna Bracket.
- **Pole Mounting:** Mount to a stationary pole (on a house for example) using the supplied Pole Mount Bracket.
DO NOT MOUNT TO A POLE ON A VEHICLE.

STEP 3: READ THE FOLLOWING INFORMATION CAREFULLY. THEN MAKE CONNECTIONS ON PAGE 3.

The KING Jack antenna is an amplified antenna that requires +12 volts power.

When using an existing power injector already in the RV

When replacing an existing amplified antenna that has an existing power injector, just replace the antenna head assembly and verify that you have power to the KING Jack antenna when the wall switch power injector is "ON." A red LED light on the bottom of the KING Jack antenna will illuminate when +12 volts is present and the internal amplifier is powered. Do not use both the existing power injector and the power injector supplied with the KING Jack Antenna!



Using two power injectors in the circuit can cause the KING Jack Antenna power supply to overheat, possibly causing injury or severe damage.



Use either the existing power injector or the KING Jack power injector.
WARNING: DO NOT USE BOTH POWER INJECTORS!

A typical power injector for an existing RV antenna will be a wall plate or an A/V distribution box with an ON/OFF type switch.

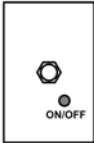
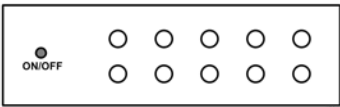
When using the KING Jack antenna with the supplied power injector

Verify that any existing power injector has been disconnected.

STEP 4: Read the OPERATING INSTRUCTIONS on page 4 for antenna pointing instructions.

Option 1: BAT WING STYLE REPLACEMENT

1. Turn off antenna power injector at wall switch or A/V switch and raise the existing antenna.
2. Attach the RV antenna bracket to the KING Jack antenna with the 4 supplied sets of lock washers and screws.
3. Unscrew coax cable and remove existing bat wing style antenna (if present) from the retractable arm (keep retaining pins and clips). Line up holes in RV antenna bracket with holes in retractable arm and re-insert pins thru assembly. Re-install retaining clips (use new supplied retaining clips if necessary).
4. Fill end of existing coax cable with supplied dielectric grease and screw to antenna (**DO NOT OVER TIGHTEN**).
Note: If existing coax connector is corroded or damaged, replace with supplied new connector.

If installing new coax cable (sold separately), connect as stated, and then route properly thru retractable arm and into vehicle. Make appropriate connections in vehicle.

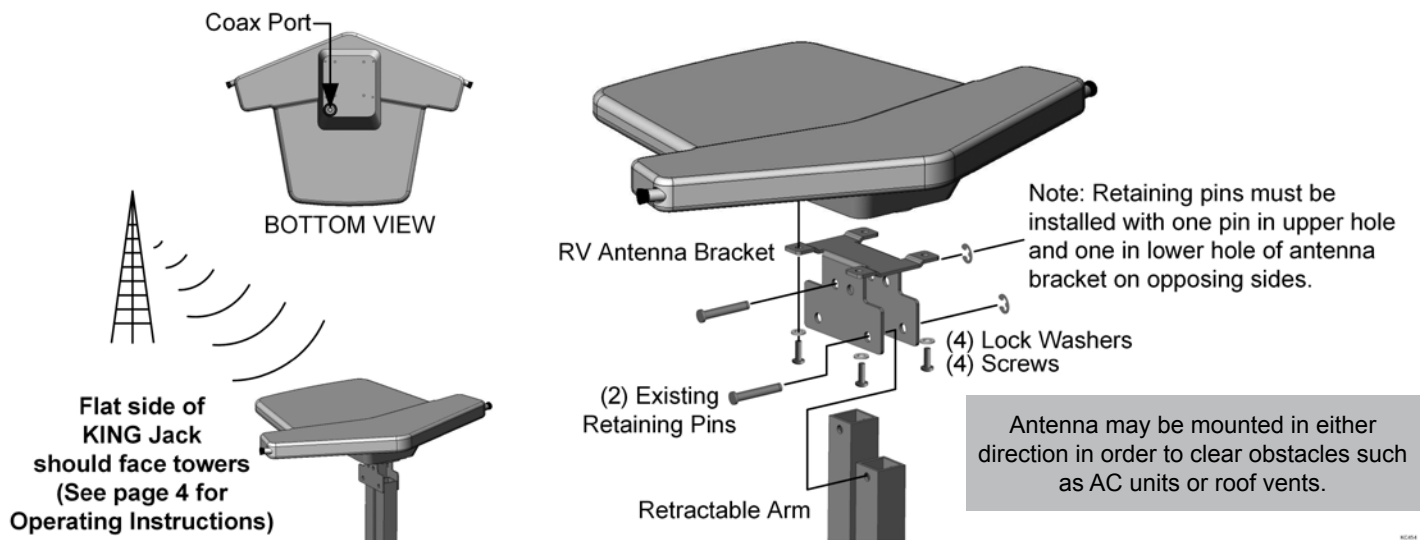

Option 2: POLE MOUNT BRACKET

1. Attach the L-shaped bracket to the KING Jack antenna with the 4 supplied sets of lock washers and screws.
2. Remove 2 existing screws and 2 existing washers from L-shaped bracket. Attach pole clamp to the L-shaped bracket with the same screws and washers.
3. Place the clamp around an appropriate pole and tighten wing nuts.
4. Fill end of coax cable (sold separately) with supplied dielectric grease and screw to antenna (**DO NOT OVER TIGHTEN**).
Note: If replacing an existing antenna and the existing coax connector is corroded or damaged, replace with supplied new connector. Route coax cable and make appropriate connections.
5. Position antenna for maximum signal reception and tighten wing nuts to secure the antenna in this position.

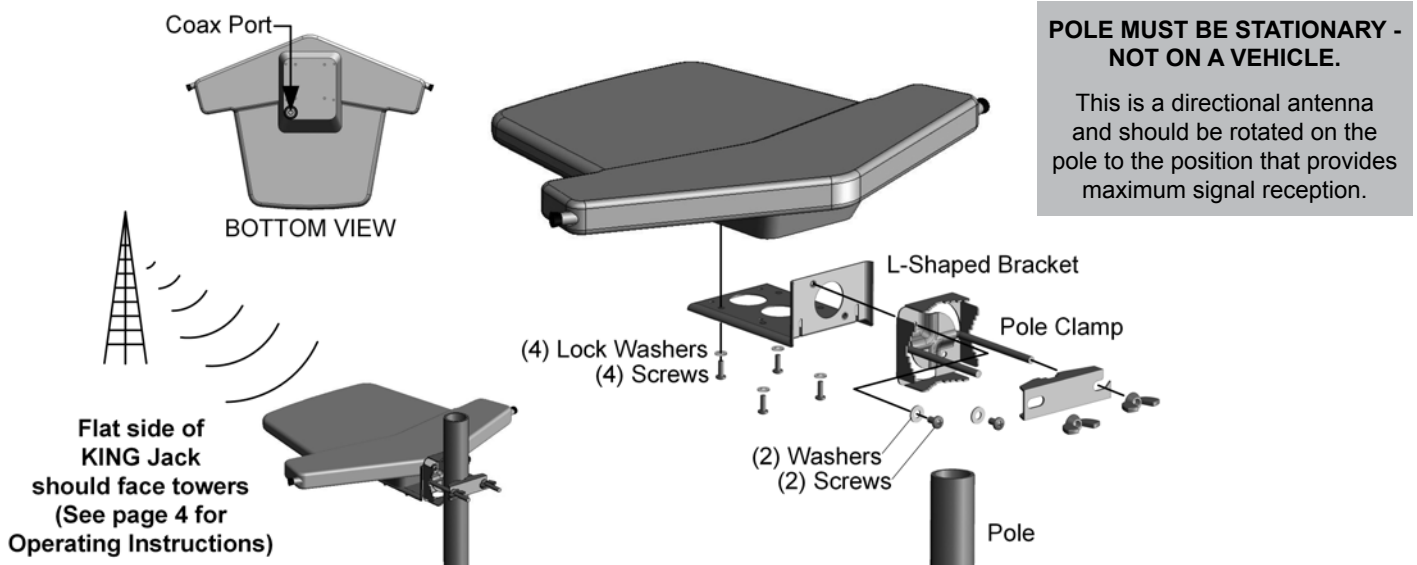

NO EXISTING POWER INJECTOR

Use power injector and power supply included with purchase of KING Jack Antenna

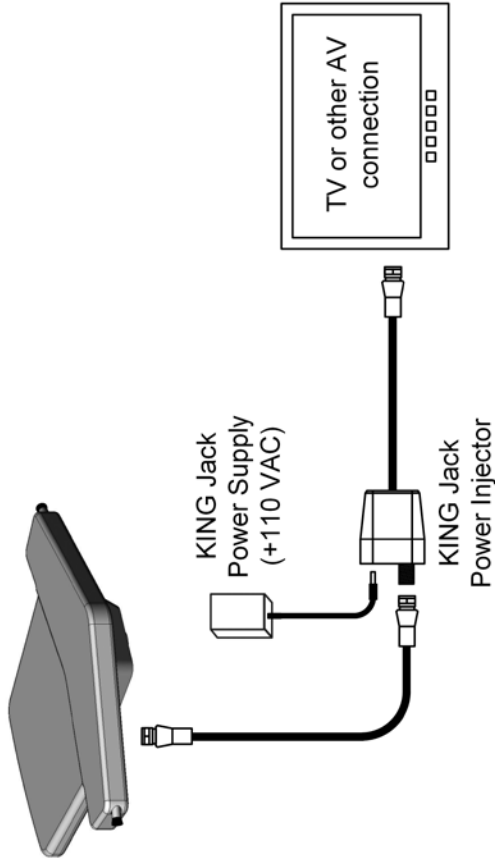

WALL PLATE TV OUTLET WITH NO POWER INJECTOR

Use power injector and power supply included with purchase of KING Jack Antenna

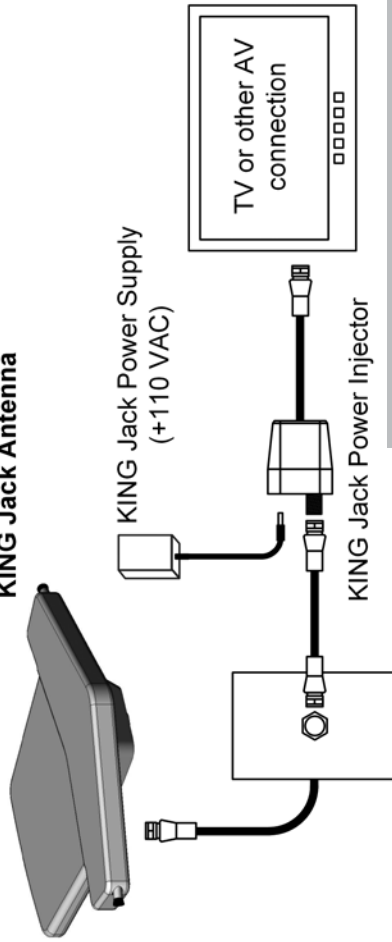

Wall Plate TV Outlet

PASSIVE-WITHOUT POWER

Example Part: Winegard® OT-8700

IMPORTANT!

Your RV may have more than one wall plate. Do not use the power injector supplied with the KING Jack antenna if an existing power injector is present.

WALL PLATE TV OUTLET WITH POWER INJECTOR
DO NOT USE THE KING JACK POWER INJECTOR IN COMBINATION WITH EXISTING INJECTOR

Examples of existing power injectors include, but are not limited to:

Winegard®

- Wall Plate RV-7012
- RV-7542
- RV-0822
- SB-2000

AV Selector VS-0503
VS-0604

AntennaTek

- 065725
- 065830
- 065840

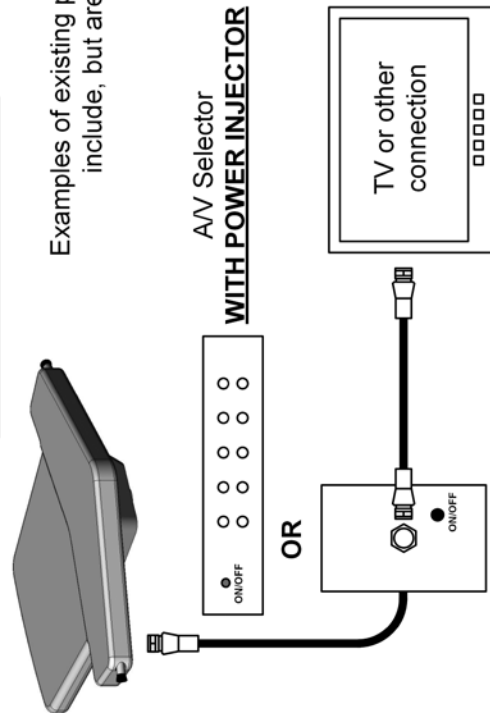

Wall Plate TV Outlet **ACTIVE-WITH POWER**

NOTE: Illustration purposes only. Other configurations exist.

DO NOT USE ANY CONFIGURATION THAT HAS BOTH THE KING JACK POWER INJECTOR AND AN EXISTING POWER INJECTOR

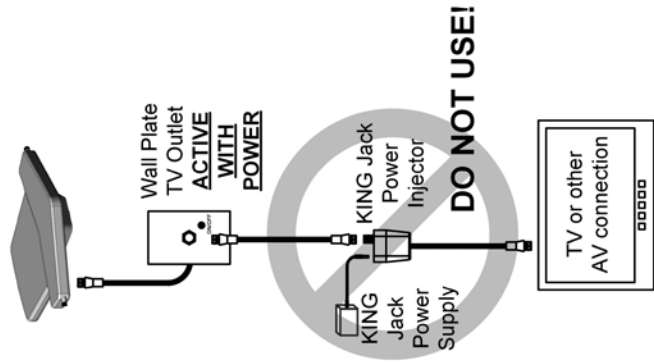

DO NOT USE!

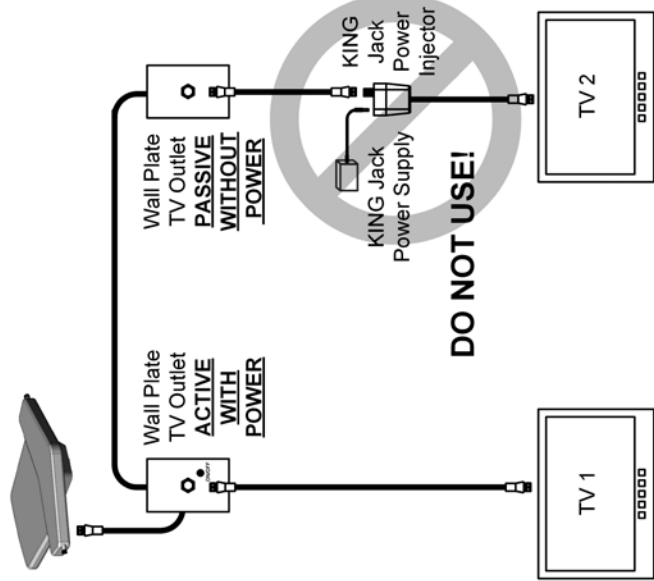

DO NOT USE!

OPERATING INSTRUCTIONS - Scanning for Channels

NOTE: In stationary applications, you only need to scan for channels one time. In mobile applications, you will need to scan for channels each time you change locations. Flat side of KING Jack (opposite pointed side) should face signal source when properly aligned.

1. Turn on TV.
2. Turn on power to KING Jack antenna.
3. Perform a channel scan per the digital TV or digital TV converter box manufacturer's instructions.
4. Rotate antenna 90 degrees. Scan again.
5. Rotate antenna 90 degrees. Scan again.
6. Rotate antenna 90 degrees. Scan again.
7. Reposition your KING antenna to where you received the most channels. Choose one of those channels on your TV. Now monitor the signal strength screen and fine tune the KING Jack until the highest signal strength is achieved. Perform one final scan and watch TV. Enjoy!

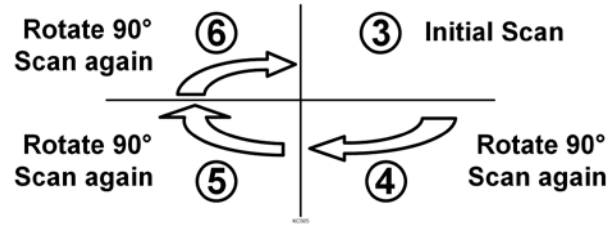

KING SureLock Digital TV Signal Finder (Sold separately)

The optional KING SureLock Digital TV Signal Finder allows you to pinpoint the location of local DTV towers and eliminate the need for multiple channel scans. Consult your local dealer or visit www.kingcontrols.com for additional information.



KING SureLock SL1000

TROUBLESHOOTING

SYMPTOM	POSSIBLE REASON	COURSE OF ACTION
No TV reception.	No power to antenna. (Red LED on antenna head is not lit.)	<p>Make sure power supply is plugged into a known good 110-120 VAC source.</p> <p>Check for 12 VDC at power supply output. If not present, replace power supply.</p> <p>Check for 12 VDC at antenna port of power injector. If voltage is not present, replace power injector.</p> <p>If voltage is present, the coax to the antenna or the antenna is bad.</p> <p>Temporarily run a known good coax from the injector to the antenna. If you now have power (red LED lit), replace the coax. If you don't, replace the antenna.</p>
	Antenna pointed in wrong direction.	Perform a 4 quadrant search as shown in the operating instructions or use a KING SureLock Signal Meter to locate TV towers.

IMPORTANT! Do not power wash any part of the KING Jack antenna.

LIMITED ONE YEAR WARRANTY

Every new KING Jack HDTV Antenna is covered by the following one year parts limited warranty from the date of original purchase:

- One year parts warranty: The customer is not responsible for the cost of replacement parts if the original part is determined to be defective under the terms of the warranty. The customer is responsible for the cost of replacement parts after one year.

Should any trouble develop during the warranty period, contact KING. You must contact KING before the warranty period expires. The customer must supply proof of purchase (such as a dated sales receipt) when requesting warranty service. If customer cannot supply proof of purchase, warranty period shall start 30 days after date of manufacture. Only KING will perform warranty evaluations and repairs.

If it is determined that the unit needs to be returned to KING, customer must return COMPLETE product, freight prepaid, to: KING, 11200 Hampshire Avenue South, Bloomington, MN 55438-2453.

If inspection shows the trouble is caused by defective workmanship or material, KING will repair (or at its option, replace) without charge.

When returning product, KING will supply an RMA number (Return Merchandise Authorization). This number must be clearly written on the box. Failure to clearly write RMA number on box may result in delays in processing claim. Along with product, customer should include in the box: his/her name, address, daytime phone number, proof of purchase and description of the problem.

This warranty does not cover installation and external wiring, or remanufactured units. This warranty is not transferable from the original owner.

This warranty also does not apply where:

- The product has been abused, misused, improperly installed or improperly maintained.
- Repairs have been made or attempted by others that are not certified by KING to do such repairs.
- Repairs are required because of normal wear and tear.
- Alterations have been made to the product.
- The product enclosure has been opened.
- Damage has been caused by power washing.
- Supplied grease not used in the external coax connection as specified in the instructions.
- Circumstances beyond the control of KING cause the product to no longer operate correctly.
- Customer is not the original owner.

In no event shall KING be liable for any indirect, incidental, or consequential damages from the sale or use of the product. This disclaimer applies both during and after the term of the warranty. KING disclaims liability for any implied warranties, including implied warranties of "merchantability" and "fitness for a specific purpose," after the one year term of this warranty.

This warranty gives you specific legal rights, and you may also have other rights, which vary from state to state. Some states do not allow the exclusion or limitation of incidental or consequential damages, so the above limitation or exclusion may not apply to you. Some states do not allow limitations on how long an implied warranty lasts, so the above limitation may not apply to you.



11200 Hampshire Avenue South, Bloomington, MN 55438
PH 952.922.6889 || FAX 952.922.8424 || kingcontrols.com

Winegard is a registered trademark of Winegard® Company. KING Jack™ and KING SureLock™ are products of KING™ and are not affiliated with nor manufactured by Winegard® Company. KING, KING Jack and KING SureLock are trademarks of Electronic Controlled Systems, Inc.