



Operations Manual



**HELIX 5 SONAR, HELIX 5 DI,
HELIX 7 SONAR, and HELIX 7 DI**

Thank You!

Thank you for choosing Humminbird®, the #1 name in marine electronics. Humminbird has built its reputation by designing and manufacturing top-quality, thoroughly reliable marine equipment. Your Humminbird is designed for trouble-free use in even the harshest marine environment. In the unlikely event that your Humminbird does require repairs, we offer an exclusive Service Policy. For complete details, see the separate warranty card included with your unit. We encourage you to read this manual carefully in order to get full benefit from all the features and applications of your Humminbird product.

Contact Humminbird Customer Service at humminbird.com or call **1-800-633-1468**.

WARNING! *This device should not be used as a navigational aid to prevent collision, grounding, boat damage, or personal injury. When the boat is moving, water depth may change too quickly to allow time for you to react. Always operate the boat at very slow speeds if you suspect shallow water or submerged objects.*

WARNING! *Disassembly and repair of this electronic unit should only be performed by authorized service personnel. Any modification of the serial number or attempt to repair the original equipment or accessories by unauthorized individuals will void the warranty.*

WARNING! *This product contains chemicals known to the State of California to cause cancer and birth defects or other reproductive harm.*

WARNING! *Do not travel at high speed with the unit cover installed. Remove the unit cover before traveling at speeds above 20 mph.*

NOTE: *The illustrations in this manual may not look the same as your product, but your unit will function in the same way.*

NOTE: *To purchase accessories for your control head, visit our Web site at humminbird.com or contact Customer Service at **1-800-633-1468**.*

NOTE: *The procedures and features described in this manual are subject to change without notice. This manual was written in English and may have been translated to another language. Humminbird is not responsible for incorrect translations or discrepancies between documents.*

NOTE: *Some features discussed in this manual require a separate purchase, and some features are only available on international models. Every effort has been made to clearly identify those features. Please read the manual carefully in order to understand the full capabilities of your model.*

ATTENTION INTERNATIONAL CUSTOMERS: Products sold in the U.S. are not intended for use in the international market. Humminbird international units provide international features and are designed to meet country and regional regulations. Languages, maps, time zones, units of measurement, and warranty are examples of features that are customized for Humminbird international units purchased through our authorized international distributors.

To obtain a list of authorized international distributors, please visit our Web site at humminbird.com or contact Humminbird Customer Service at **(334) 687-6613**.

Down Imaging®, DualBeam PLUS™, Fish ID+™, HELIX™, HumminbirdPC™, Humminbird®, Real Time Sonar™, RTS™, RTS Window™, Structure ID™, SwitchFire®, Total Screen Update™, WhiteLine™, and X-Press™ Menu are trademarked by or registered trademarks of Johnson Outdoors Marine Electronics, Inc.

Adobe, Acrobat, Adobe PDF, and Reader are either registered trademarks or trademarks of Adobe Systems Incorporated in the United States and/or other countries.

Baekmuk Batang, Baekmuk Dotum, Baekmuk Gulim, and Baekmuk Headline are registered trademarks owned by Kim Jeong-Hwan.

Table of Contents

HELIX Series Introduction	1
How Sonar Works	1
Power On	5
What's on the Control Head	6
Key Functions	7
What's on the Sonar Display	10
What's on the Down Imaging Display	16
Views	20
Select a View.....	20
Display your Favorite Views	20
Change Digital Readouts	21
Combo Views.....	33
The Menu System	35
Start-Up Options Menu	36
X-Press Menu	39
Main Menu	40
Quick Tips for the Main Menu	41
Note for all Menu Settings	41
User Mode (Normal or Advanced)	42
Sonar X-Press Menu	44
Down Imaging X-Press Menu	49
Flasher X-Press Menu	53
Alarms Menu Tab	57
Sonar Menu Tab	60
Setup Menu Tab	70
Maintenance	77
Troubleshooting	78
HELIX Control Head Measurements	81
Specifications	85
Contact Humminbird	88

Table of Contents

***NOTE:** Entries in this Table of Contents which list (International models only) are only available on products sold outside of the U.S. by our authorized international distributors. To obtain a list of authorized international distributors, please visit our Web site at humminbird.com or contact Humminbird Customer Service at (334) 687-6613.*

***NOTE:** Entries in this Table of Contents which list (with Speed Input) or (with Temperature Input) may require the purchase of separate accessories. You can visit our Web site at humminbird.com to order these accessories online or contact Humminbird Customer Service at 1-800-633-1468.*

HELIX Series Introduction

The HELIX Series Fishfinder is available in several different configurations. See the following list of products, all of which are covered by this manual, to find your HELIX Series model:

- **HELIX SONAR:** Wide screen Fishfinder with DualBeam PLUS sonar.
- **HELIX DI:** Wide screen Fishfinder with Down Imaging sonar and traditional 2D sonar.

NOTE: Some features discussed in this manual require a separate purchase, and some features are only available on international models. Every effort has been made to clearly identify those features. Please read the manual carefully in order to understand the full capabilities of your model.

How Sonar Works

Sonar technology is based on sound waves. The HELIX Series Fishfinder uses sonar to locate and define structure, bottom contour and composition, as well as depth directly below the transducer.

Your HELIX Series Fishfinder sends a sound wave signal and determines distance by measuring the time between the transmission of the sound wave and when the sound wave is reflected off of an object; it then uses the reflected signal to interpret location, size, and composition of an object.

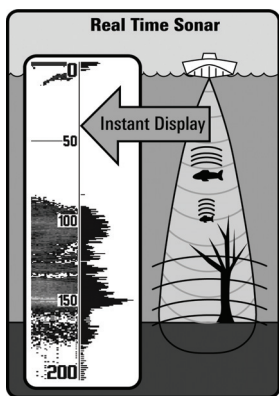

Sonar is very fast. A sound wave can travel from the surface to a depth of 240 ft (70 m) and back again in less than 1/4 of a second. It is unlikely that your boat can "outrun" this sonar signal.

SONAR is an acronym for SOund and NAVigation Ranging. Sonar utilizes precision sound pulses or "pings" which are emitted into the water in a teardrop-shaped beam.

The sound pulses "echo" back from objects in the water such as the bottom, fish, and other submerged objects. The returned echoes are displayed on the LCD screen. Each time a new echo is received, the old echoes are moved across the LCD, creating a scrolling effect.

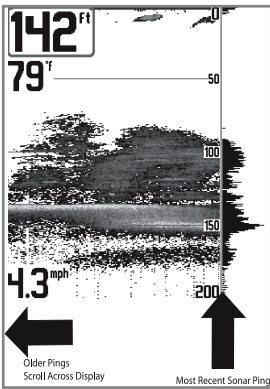

When all the echoes are viewed side by side, an easy to interpret “graph” of the bottom, fish, and structure appears.

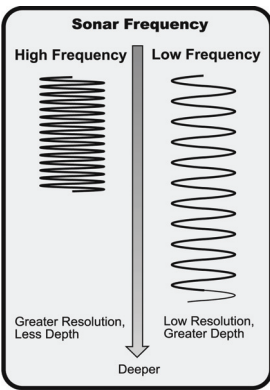

The sound pulses are transmitted at various frequencies depending on the application. Very high frequencies (455 kHz) are used for greatest definition but the operating depth is limited. High frequencies (200 kHz) are commonly used on consumer sonar and provide a good balance between depth performance and resolution. Low frequencies (83 kHz) are typically used to achieve greater depth capability.

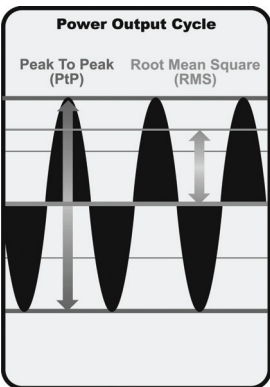

The power output is the amount of energy generated by the sonar transmitter. It is commonly measured using two methods:

- **Root Mean Square (RMS)** measures power output over the entire transmit cycle.
- **Peak to Peak** measures power output at the highest points.

The benefits of increased power output are the ability to detect smaller targets at greater distances, ability to overcome noise, better high speed performance, and enhanced depth capability.

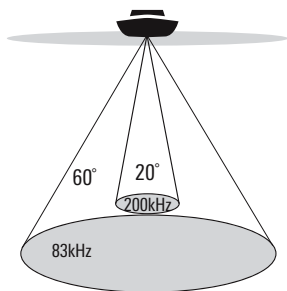

⚡ 60 Degree Total Coverage

⚡ Bottom Coverage = 1 x Depth

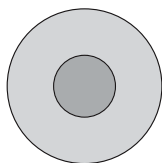

DualBeam PLUS Sonar

(HELIX SONAR)

The **HELIX SONAR Fishfinder** uses a 200/83 kHz DualBeam PLUS sonar system with a wide (60°) area of coverage. DualBeam PLUS sonar has a narrowly focused 20° center beam, surrounded by a second beam of 60°, expanding your coverage to an area equal to your depth. In 20 feet of water, the wider beam covers an area 20 feet wide.

DualBeam PLUS sonar returns can be blended together, viewed separately, or compared side-by-side. DualBeam PLUS is ideal for a wide range of conditions - from shallow to very deep water in both fresh and salt water. Depth capability is affected by such factors as boat speed, wave action, bottom hardness, water conditions, and transducer installation.

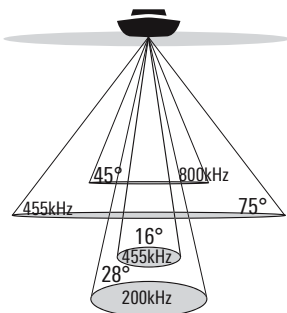

⚡ 75 Degree Total Coverage

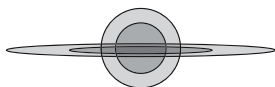

Down Imaging Sonar

(HELIX DI)

The **HELIX DI Fishfinder** uses Down Imaging technology. The Down Imaging transducer scans the water with razor-thin, high-definition beams. The beams are wide (side to side) but very thin front to back.

The Down Imaging beams can be operated at two frequencies: 455 kHz (75°) or 800 kHz (45°). Select 455 kHz for the best overall image quality and depth. Select 800 kHz for the sharpest image. See **Sonar Menu Tab: Imaging Frequency** for more information.

The transducer also uses conical beams to provide data in traditional 2D format (see **What's on the Sonar Display**). Select 455 kHz for a narrowly focused 16° center beam, or select 200 kHz for a wider 28° beam (see **Sonar Menu Tab: Beam Select**).

Depth capability is affected by such factors as boat speed, wave action, bottom hardness, water conditions, and transducer installation.

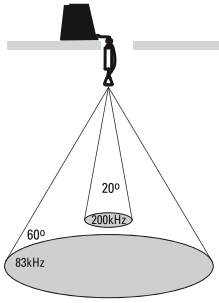

❖ 60 Degree Total Coverage

❖ Bottom Coverage = 1 x Depth

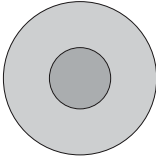

Dual Beam Ice Transducer

(with optional-purchase XI 9 20 Ice Transducer)

The **XI 9 20 Ice Transducer** provides selectable dual-frequency sonar with a wide area of coverage. Selectable dual-frequency gives you the option of two beams, and both beams will cover the bottom and provide high definition. The 20° center beam provides the highest definition, while the 60° beam provides wider coverage.

Depth capability is affected by such factors as bottom hardness and water conditions. Whether fishing in shallow or very deep water, selectable dual-frequency is ideal for a variety of conditions.

NOTE: Visit our Web site at humminbird.com to determine which accessory transducers are compatible with your Humminbird Fishfinder, or contact Customer Service at **1-800-633-1468**.

Power On

Follow the instructions below to power on your Humminbird control head.

HELIX Series Title Screen



1. Press the  POWER/LIGHT key.
2. When the Title screen is displayed, press the MENU key to access the Start-Up Options Menu.
3. Select Normal, and press the RIGHT Cursor key.
 - If you wait too long to select a Start-Up Option, the system will default to whichever menu is already highlighted.
 - If a functioning transducer is connected, Normal operation will be selected automatically, and your control head can be used on the water.
 - You can also select **Simulator** to learn how to use your control head and save settings in advance for later use. See *Start-Up Options Menu* for more information.
4. **Quick Setup:** If this is the first time the unit has been powered on (after installation or after restoring defaults), the Quick Setup dialog box will display on the screen. Use the 4-WAY Cursor Control key to change the settings. Press the EXIT key to close the dialog box.

NOTE: The Quick Setup settings can be changed at any time. See each menu option in *The Menu System* for details.

What's on the Control Head

Your HELIX Series user interface is easy to use. A combination of keys, different views, and situation-specific, customizable menus allows you to control what you see on the color display. Refer to the following illustration and see *Key Functions*, *Views*, and *The Menu System* for more information.

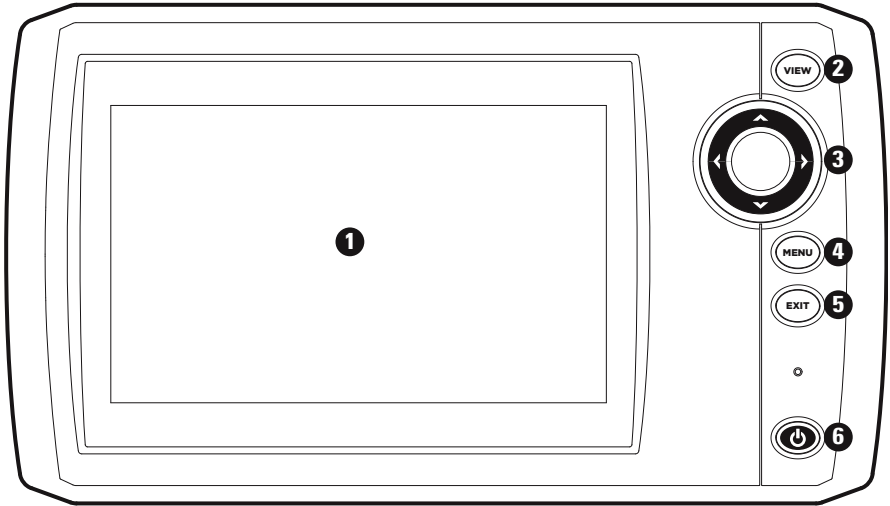

- 1 screen
- 2 VIEW key
- 3 4-WAY Cursor Control key (LEFT, RIGHT, UP, or DOWN)

- MENU key 4
- EXIT key 5
- POWER/LIGHT key 6

Key Functions

Your control head consists of a set of easy-to-use keys that work with various on-screen views and menus.



POWER/LIGHT Key

The **POWER/LIGHT key** is used to power the Fishfinder on and off. You can also use the POWER/LIGHT key to adjust the backlight and contrast of the display.

Power On: Press the POWER/LIGHT key to power on the unit. When the Title screen is displayed, press the MENU key to access the Start-Up Options Menu.

Power Off: Press and hold the POWER/LIGHT key for 3 seconds. A message will appear to indicate how many seconds there are until shutdown occurs. To ensure that shutdown occurs properly and any menu settings will be saved, your Fishfinder should always be turned off using the POWER/LIGHT key.

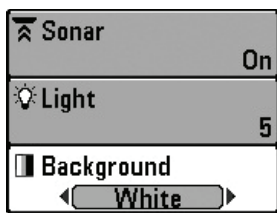

Adjust the Backlight or the Display Background Color: Press the POWER/LIGHT key to access the Light and Background submenu. Use the 4-WAY Cursor Control key to select Light or Background, and then use the LEFT or RIGHT Cursor key to change the settings. Press EXIT to exit the Light and Background submenu.

Turn Sonar On or Off: From the Light and Background submenu, use the 4-WAY Cursor Control key to select Sonar. Use the LEFT or RIGHT Cursor key to change the setting. See **Setup Menu Tab: Sonar** for more information.



VIEW Key

The **VIEW key** is used to cycle through all available views. Press the VIEW key to advance to the next view. Press the VIEW key repeatedly to cycle through all available views. Views can be hidden to optimize the system to your fishing requirements (see **Views** or **Setup Menu Tab: Select Views**).

NOTE: Press the EXIT key to cycle through the views in reverse order.



MENU Key

The **MENU key** is used to access the menu system. See *The Menu System* for more information.

Start-Up Options Menu: Press the MENU key during the power up sequence to view the Start-Up Options menu.

X-Press Menu: Press the MENU key once in any view to access the X-Press Menu, which provides frequently-used menu settings that correspond with the current view.

Main Menu: Press the MENU key twice in any view to access the Main Menu, which is organized under tabbed headings to help you find a specific menu item quickly.



4-WAY Cursor Control Key

(RIGHT, LEFT, UP, or DOWN Cursor Keys)

The **4-WAY Cursor Control key** has multiple functions, which depend on the view, menu, or situation.

- **Menu Selection:** Press the DOWN or UP Cursor keys to highlight a menu option, then press the RIGHT or LEFT Cursor keys to change a menu setting. The changes will be activated and saved immediately.
- **Freeze Frame:** In Sonar Views and Down Imaging Views, press any arrow on the 4-WAY Cursor Control key to freeze the display and move the active cursor to a location on the screen. A cursor dialog box will display to show the depth of the location you choose.
- **Active Cursor:** Press any arrow on the 4-WAY Cursor Control key, and the active cursor will appear on the screen.

***NOTE:** In Freeze Frame or Active Cursor mode, you can also make the cursor move diagonally by pressing in between two of the arrows on the 4-WAY Cursor Control key.*

- **Circular Flasher View (Ice Fishing Mode: On):** Press the UP or DOWN Cursor keys to move the Depth Cursor. Press the RIGHT or LEFT Cursor keys to adjust the Zoom Range (see *Views: Circular Flasher View*).



EXIT Key

The **EXIT key** has multiple functions, which depend on the situation.

- **If an alarm is sounding**, press the EXIT key to cancel the alarm.
- **If a menu tab is selected**, press the EXIT key to exit the menu mode and return to the view.
- **If a menu is active**, press the EXIT key to return to the previous level in the menu system.
- **From any view**, press the EXIT key to cycle through the available views in reverse order.
- **If Freeze Frame is active**, press the EXIT key to return to a scrolling display.
- **If the Cursor is active**, press the EXIT key to remove the cursor from the display.
- **If Down Imaging Zoom is active**, press the EXIT key to remove the magnification box from the display and remove the cursor.

What's on the Sonar Display

The Fishfinder can display a variety of useful information about the area under and adjacent to

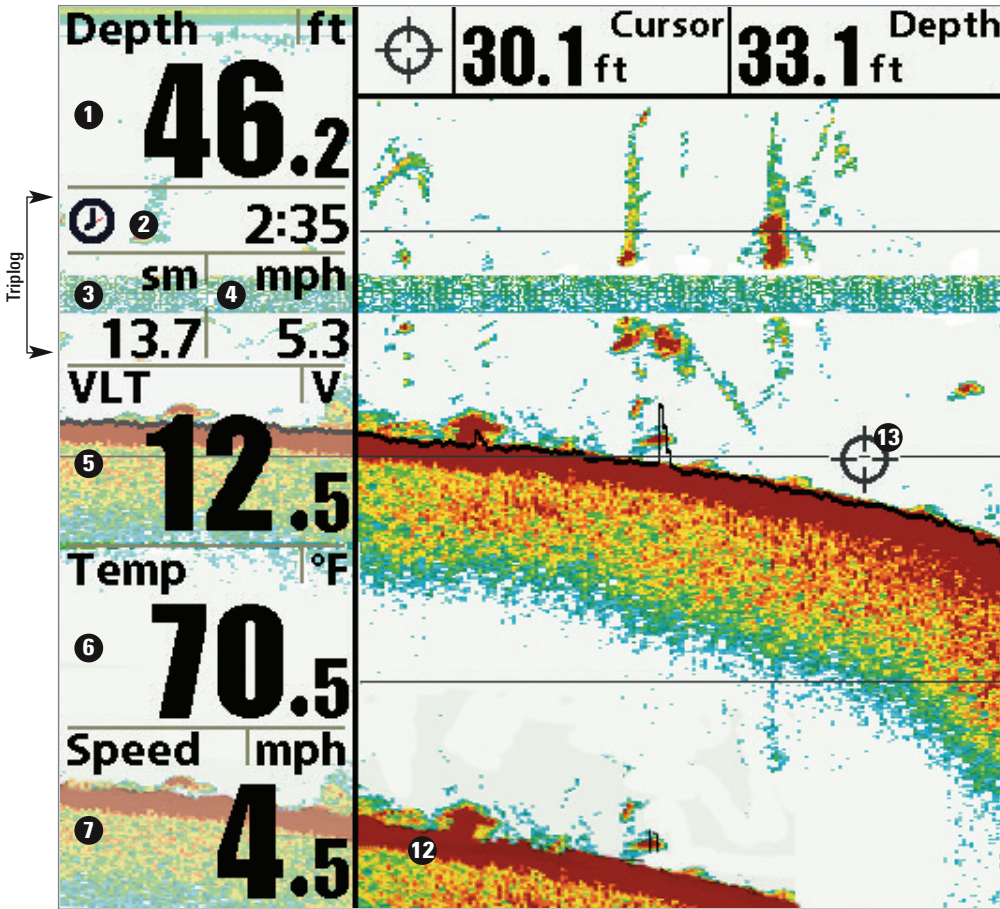

① **Depth** - Water depth can be set to alarm when the water becomes too shallow.

② **Timer** - Elapsed time with Speed accessory or GPS receiver.

③ **Distance** - Distance traveled with Speed accessory or GPS receiver.

④ **Average Speed** - Average speed reading with Speed accessory or GPS receiver.

your boat, including the following items:

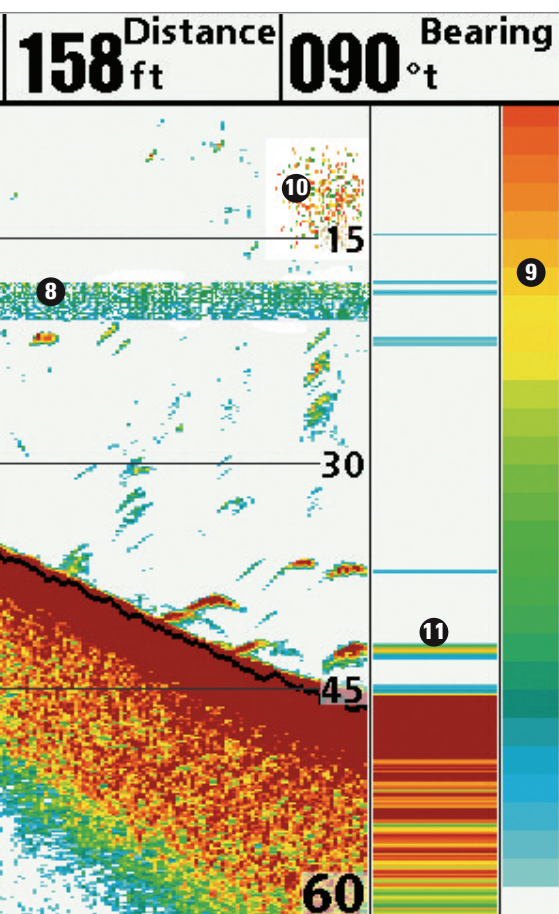

- 8 **Thermoclines** - Layers of water with different temperatures that appear at different depths and different times of the year. A thermocline typically appears as a continuous band of many colors moving across the display at the same depth.
- 9 **Sonar Color Bar** - Color spectrum indicating low to high sonar intensity returns, where red indicates high intensity and white indicates low intensity.
- 10 **Bait Ball**
- 11 **RTS (Real Time Sonar) Window**
- 12 **Second Sonar Return** - When the sonar signal bounces between the bottom and the surface of the water and back again. Use the appearance of the second return to determine bottom hardness. Hard bottoms will show a strong second return, while soft bottoms will show a very weak one or none at all.
- 13 **Cursor** - Available in Freeze Frame and can be positioned in the Sonar View to provide depth of a sonar return and bottom depth below the cursor. The Latitude and Longitude of the cursor position, the distance to travel to the cursor position, and the bearing to the cursor position are shown with a connected GPS receiver. Cursor information is displayed at the top of the screen.

- 5 **Voltage** - Power supplied to the control head.
- 6 **Temperature** - Water surface temperature.
- 7 **Speed** - If a Speed accessory or GPS receiver is connected, the Fishfinder can display the speed of the boat, and can keep a triplog of nautical or statute miles traveled.

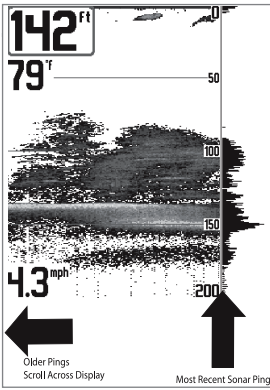

Understanding the Sonar Display

It is important to understand the significance of the display. The display does NOT show a literal 3-dimensional representation of what is under the water. Each vertical band of data received by the control head and plotted on the display represents something that was detected by a sonar return at a particular time. As both the boat and the targets (fish) may be moving, the returns are only showing a particular segment of time when objects were detected, not exactly where those objects are in relation to other objects shown on the display.

The returned sonar echoes are displayed on the screen. As a new echo is received, the historical data scrolls left across the display.

Real Time Sonar (RTS) Window

A **Real Time Sonar (RTS) Window** appears on the right side of the display in the Sonar Views only. The RTS Window always updates at the fastest rate possible for depth conditions and shows only the returns from the bottom, structure and fish that are within the transducer beam. The RTS Window plots the depth and intensity of a sonar return. (See *Sonar Menu Tab: Real Time Sonar (RTS) Window*).

The **Narrow RTS Window** indicates the sonar intensity through the use of colors. Red indicates a strong return and blue indicates a weak return. The depth of the sonar return is indicated by the vertical placement of the return on the display depth scale.

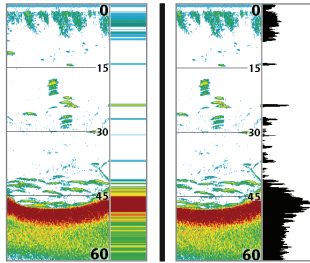

The **Wide RTS Window** indicates the sonar intensity through the use of a bar graph. The length of the plotted return provides an indication of whether the return is weak or strong. The depth of the sonar return is indicated by the vertical placement of the return on the display depth scale. The Wide RTS Window does not use grayscale.

Sonar Colors: Original Palette



Sonar Colors and Bottom View

As the boat moves, the unit charts the changes in depth on the display to create a profile of the **Bottom Contour**. The Sonar View displays the sonar return intensity with different colors.

Strong returns often result from rocky or hard bottoms (compacted sediment, rocks, fallen trees), while **weaker returns** often result from soft bottoms (sand, mud), vegetation, and small fish.

The colors used to represent high, medium, to low intensity returns are determined by the palette you choose in the **Sonar Colors** menu option. See *Sonar Menu Tab* to set the Sonar Colors.

Sonar View: Original Palette

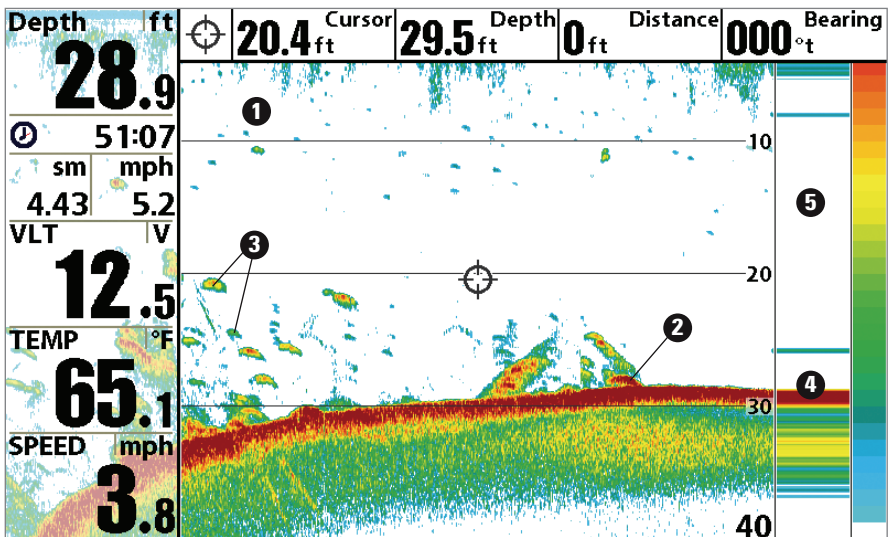

- ① sonar history: historical returns scroll left across the view
- ② strong returns (possibly rocks, tree limbs, or other structure)
- ③ weak returns (possibly vegetation or small fish)
- ④ strong return (possibly compacted sediment or rocks)
- ⑤ RTS window

Use **Bottom View** to select the method used to represent bottom and structure on the display. See *Sonar Menu* to set the Bottom View.

Structure ID represents weak returns in blue and strong returns in red when Sonar Colors is set to Original. If the Sonar Colors palette is changed, the Structure ID will display the strongest return as specified by the palette. See *Sonar Menu Tab: Sonar Colors* for more information.

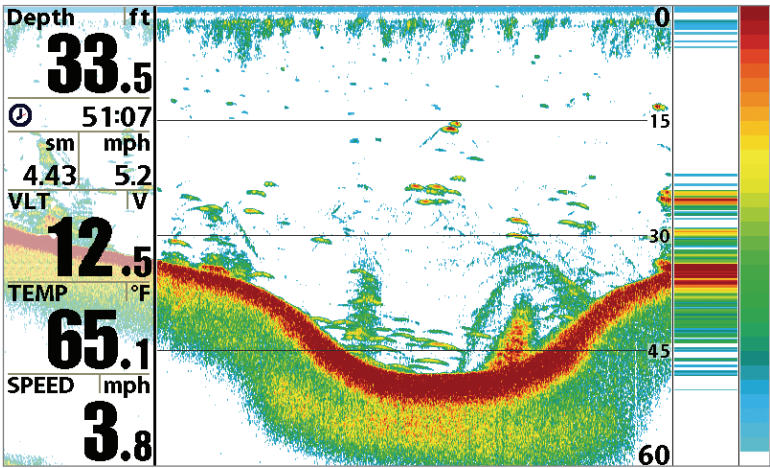

WhiteLine highlights the strongest sonar returns in white, resulting in a distinctive outline. This has the benefit of clearly defining the bottom on the display.

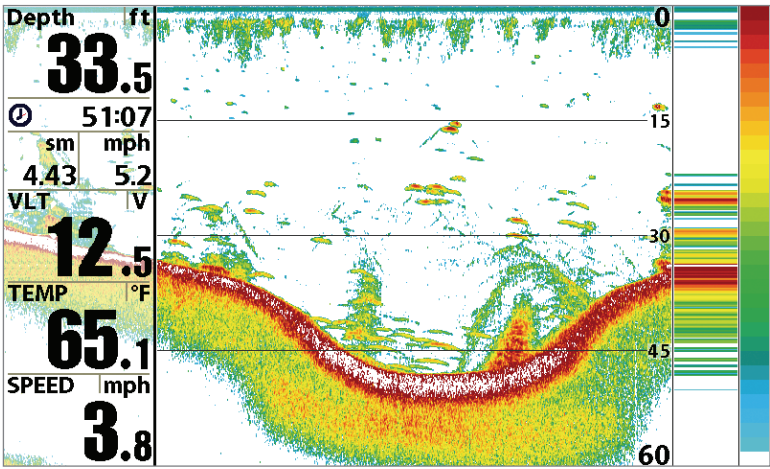

SwitchFire

SwitchFire controls how the sonar returns are displayed in the Sonar Views. SwitchFire settings are available in the Sonar Menu Tab.

To see the maximum sonar information available within the transducer beam so more fish arches and better jig tracking are shown, choose Max Mode.

To see less clutter and more fish size accuracy interpreted from the transducer beam, choose Clear Mode. See *Sonar Menu Tab: SwitchFire* for more information.

Freeze Frame and Active Cursor

Freeze Frame & Active Cursor - Press any arrow on the 4-WAY Cursor Control key, and the screen will freeze and a cursor will be displayed. Use the 4-WAY Cursor Control key to move the cursor over a sonar return, and the depth of the sonar return will be displayed in the cursor dialog box.

The **RTS Window** continues to update in Freeze Frame. To return to a scrolling display and exit Freeze Frame, press the EXIT key. Freeze Frame is available in the Sonar, Split Sonar, and Sonar Zoom Views.

Instant Image Update

Instant Image Update - You can change a variety of sonar menu settings (such as Sensitivity or Upper Range), and the adjustments will be shown instantly on the screen.

What's on the Down Imaging Display

Down Imaging uses unique sonar technology to provide information about the area directly below you see on the display. Down Imaging reveals a variety of recognizable features so that you can

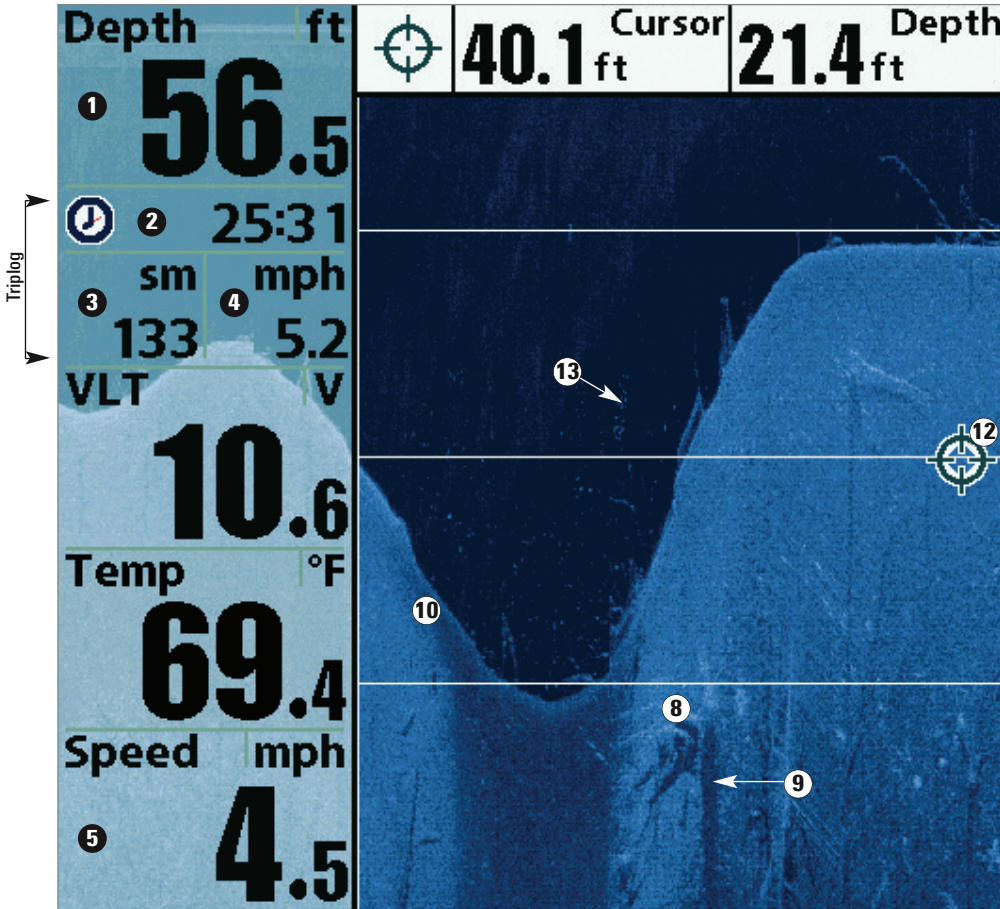

1 **Depth** - Water depth can be set to alarm when the water becomes too shallow.

2 **Timer** - Elapsed time with Speed accessory or GPS receiver.

3 **Distance** - Distance traveled with Speed accessory or GPS receiver.

4 **Average Speed** - Average speed reading with Speed accessory or GPS receiver.

5 **Speed** - If a GPS Receiver or Temp/Speed accessory is connected, the Fishfinder can display the speed of the boat and can keep a Triplog of nautical or statute miles traveled.

your boat. The razor-thin, high-definition profiling beams produce the detailed sonar data that interpret the structure and bottom contour, including the following items:

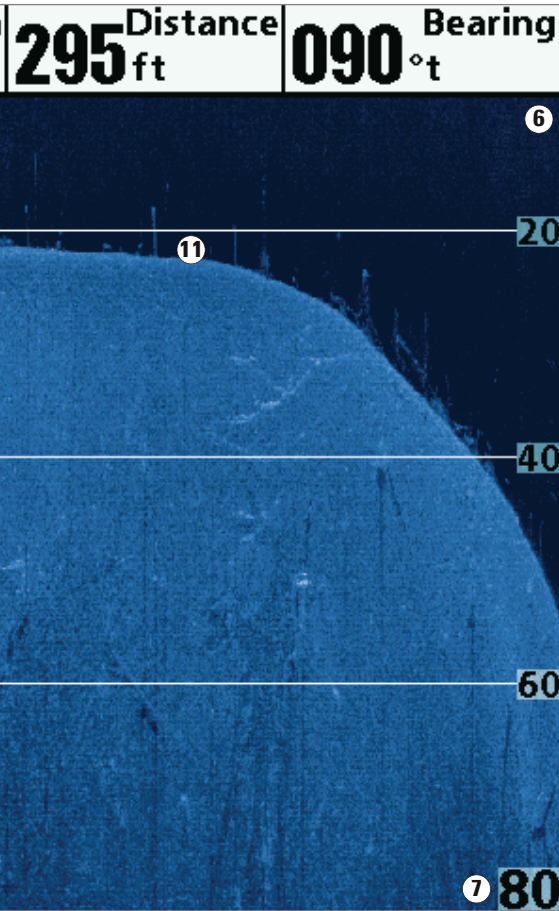

- 9 **Shadows** - result from a lack of reflected sonar from a particular area and can be as valuable for interpretation than the sonar reflected by the object itself. Use shadows to help you see the image in 3 dimensions, oriented in space. You can gain insight into the actual shape of an object, or the depth to which it has sunk into the bottom, through shadows on the display. Objects standing on the bottom cast a sonar shadow. The longer the shadow, the taller the object. Fish also cast shadows. You can use the shadow to interpret how close the fish is to the bottom.
- 10 **Topography Changes** - The light part of the display shows where the beam is hitting hard bottom or rising terrain. The dark part of the display indicates soft bottom (sand, mud) or descending terrain.
- 11 **Bottom Return** - Use the appearance of the bottom return to determine bottom hardness. Rock and gravel provide a clearer sonar return than mud and sand because hard objects reflect sonar better than soft objects.
- 12 **Freeze Frame** - Use the 4-WAY Cursor Control key to move the cursor to an area on the screen.
- 13 **Clouded Area** may indicate a bait ball and **White Streaks** may indicate fish.

- 6 Upper Range
- 7 Lower Range
- 8 Structure

NOTE: Entries in this view that list (with Temp/Speed or GPS receiver) are available if either device is connected to the HELIX Series Fishfinder. If both devices are connected, then only the information from the GPS receiver will be displayed on the view.

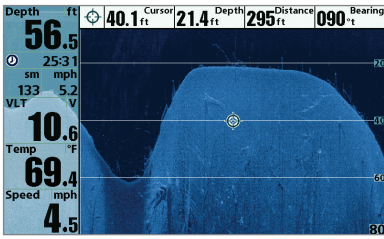

Understanding the Down Imaging Display

The images you see on the Down Imaging display are produced using sonar technology. Each time the unit pings, a strip of data representing all the echoes received by the transducer are put together on the display to form the image that you see. Like traditional 2D sonar, the sonar history scrolls left across the screen.

Interpreting the Display

Down Imaging beams “illuminate” the bottom contour, structure, and fish. The beams are wide (side to side) but very thin front to back.

Use the light and dark parts of the display to interpret the objects under your boat as follows:

- **Dark shades** represent soft returns (mud, sand) or descending terrain.
- **Light shades** represent denser terrain (timber, rocks) or rising terrain. A very hard bottom may appear as **white** on the display.
- **White Streaks** or **Clouds** may represent fish on the display.
- **Shadows** are not caused by light but by the lack of a sonar return. Objects standing on the bottom cause a sonar shadow to appear on the display. The longer the shadow, the taller the object. Fish may also cast shadows. You can use the shadow to interpret where the fish or object is located in relation to the bottom.

Down Imaging Sensitivity

Use **Down Sensitivity** to control how the sonar returns appear on the display. Increase the sensitivity to reveal weaker returns that may be of interest, especially in very clear water or greater depths. Decrease the sensitivity to eliminate the clutter from the display that is sometimes present in murky or muddy water. See the *Down Imaging X-Press Menu: Down Sensitivity* for more information.

Freeze Frame and Active Cursor

Freeze Frame and Active Cursor: Press any arrow on the 4-WAY Cursor Control key, and the screen will freeze and a cursor will be displayed. Use the 4-WAY Cursor Control key to move the cursor over a sonar return, and the depth of the sonar return will be displayed in the cursor dialog box.

DI Zoom: Use DI Zoom to see returns near the cursor location at a higher magnification. For more information, see *Views: Down Imaging View*.



Views

The sonar information from your Fishfinder is displayed on the screen in a variety of easy-to-read views. There are many views available on your Fishfinder.

Select a View

The available views on your Humminbird unit will vary with the model you've purchased and the transducer attached to the control head. See *Setup Menu Tab: Select Views* and the following pages for more information.



Next View: Press the VIEW key to advance to the next view in the View Rotation. Press the VIEW key repeatedly until the view you want to use is displayed on the screen.



Previous View: Press the EXIT key to see the previous view in the View Rotation. Press the EXIT key repeatedly until the view you want to use is displayed on the screen.

Display your Favorite Views

You can display or hide any view so that each time you press the VIEW key, only your favorite views are displayed on the screen.

1. Press the MENU key twice to open the Main Menu.
2. Press the RIGHT Cursor key until the Views tab is selected.
3. Press the UP or DOWN Cursor keys to select a view.
4. Press the LEFT or RIGHT Cursor keys to select Hidden or Visible.

Change Digital Readouts

Each view displays digital readout information (such as speed or time), which varies with the view displayed on-screen and connected accessories.

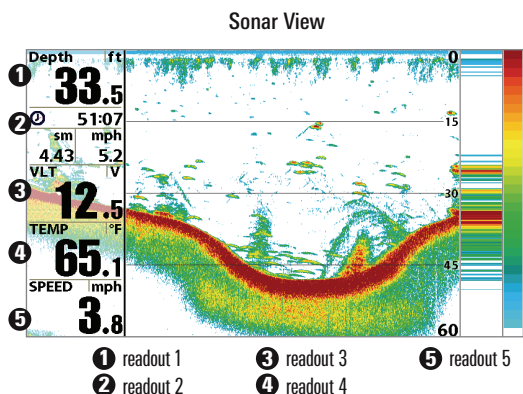

In Sonar View, Sonar Zoom View, Split Sonar View, and Down Imaging View, you can choose which digital readouts you want to display. See *Setup Menu Tab: Select Readouts* for more information.

1. Press the MENU key twice to open the Main Menu. Press the RIGHT Cursor key until the Setup tab is selected.
2. Press the DOWN Cursor key to highlight Select Readouts, and press the RIGHT Cursor key.

NOTE: If the Select Readouts option does not appear under the Setup Tab, change the User Mode to Advanced (Setup tab > User Mode > Advanced).

3. Press the UP or DOWN Cursor keys to select a Readout window. Press the RIGHT or LEFT Cursor keys to choose a digital readout.

Blank: To hide a data window, select Off.

Sonar View

Sonar View presents a historical log of sonar returns. The most recent sonar returns are charted on the right side of the display. As new information is received, the historical information scrolls left across the display.

- **Upper and Lower Depth Range numbers** indicate the distance from the surface of the water to a depth range sufficient to show the bottom.
- **Depth** is automatically selected to keep the bottom visible on the display, although you can adjust it manually as well (see *Sonar X-Press Menu*).
- **Digital Readouts** shown on the display will change based on the Select Readouts settings or the optional-purchase accessories attached (see *Setup Menu Tab: Select Readouts*).
- **Freeze Frame**: Use the 4-WAY Cursor Control key to freeze the display and move the cursor over a sonar return. The depth of the sonar return will be displayed at the top of the screen in the cursor dialog box.

Sonar View

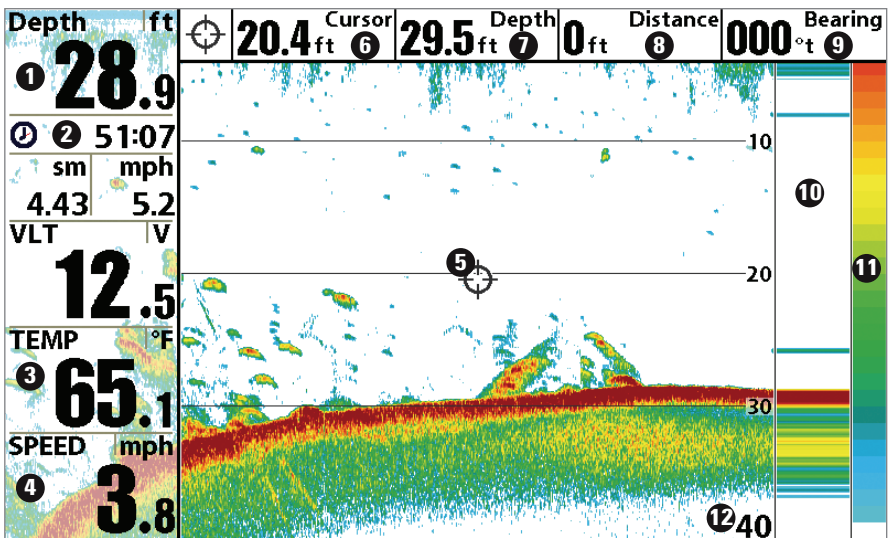

- | | |
|-------------------|----------------------|
| ① depth | ⑦ depth below cursor |
| ② triplog | ⑧ distance to cursor |
| ③ temperature | ⑨ bearing to cursor |
| ④ speed | ⑩ RTS window |
| ⑤ cursor | ⑪ sonar color bar |
| ⑥ depth of cursor | ⑫ lower depth range |

NOTE: If the Depth number is flashing, it means that the unit is having trouble locating the bottom. This usually happens if the water is too deep, the transducer is out of the water, the boat is moving too fast, or for any other reason that the unit can't accurately receive continuous data.

Sonar Zoom View

Sonar Zoom View provides a magnified view of the bottom and structure. The Sonar Zoom View makes it easier to see separate sonar returns that would usually be displayed close together, such as those caused by fish suspended close to the bottom or within structure.

- The **Zoom Level**, or magnification, is displayed in the top left corner of the display. Press the MENU key once to access the Sonar X-Press Menu. Highlight Zoom Level, and press the LEFT or RIGHT Cursor keys to adjust the Zoom Level.
- The **Zoomed View** is displayed on the left side of the screen. As the depth changes, the zoomed view updates automatically.
- The **Full Range View** is displayed on the right side of the screen. The Full Range View includes the Zoom Preview Box, which shows where the zoomed view is in relation to the full range view.
- The **Upper and Lower Depth Range numbers** indicate the high and low range of the water which is being viewed.
- **Digital Readouts** shown on the display will change based on the Select Readouts settings or the optional-purchase accessories attached (see *Setup Menu Tab: Select Readouts*).
- **Freeze Frame:** Use the 4-WAY Cursor Control key to freeze the display and move the cursor over a sonar return. The depth of the sonar return will be displayed in the cursor dialog box.

Sonar Zoom View

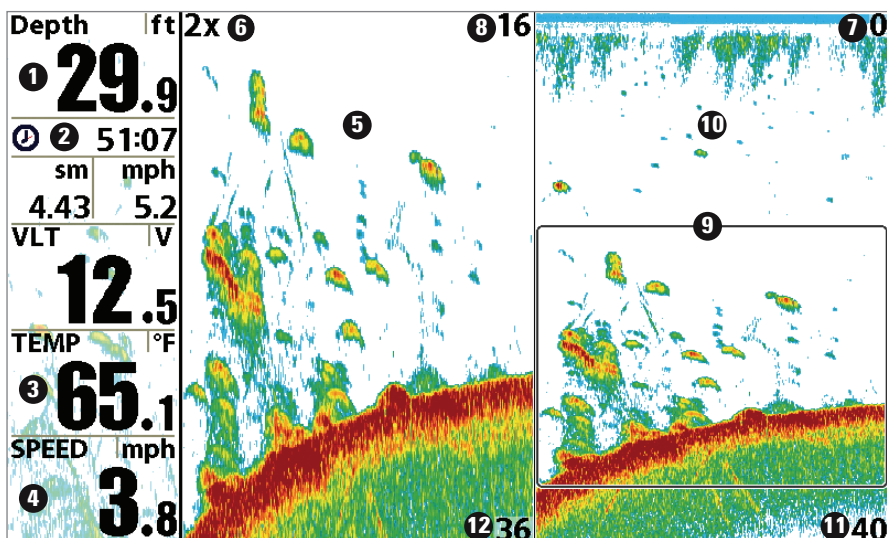

- ① depth
- ② triplog
- ③ temperature
- ④ speed
- ⑤ zoomed view
- ⑥ zoom level

- ⑦ upper depth range, full range view
- ⑧ upper depth range, zoom view
- ⑨ zoom preview box
- ⑩ full range view
- ⑪ lower depth range, full range view
- ⑫ lower depth range, zoom view

Split Sonar View

Split Sonar View displays sonar returns from each down beam frequency on separate sides of the screen. You can use the Split Sonar View to make side by side comparisons between the sonar returns from both beams.

- **HELIX SONAR models** display sonar returns from the 83 kHz wide beam on the left side of the screen and sonar returns from the 200 kHz narrow beam on the right side of the screen.
- **HELIX DI models** display traditional 2D sonar returns from the 455 kHz narrow beam on the left side of the screen and sonar returns from the 200 kHz wide beam on the right side of the screen.
- **Digital Readouts** shown on the display will change based on the Select Readouts settings or the optional-purchase accessories attached (see *Setup Menu Tab: Select Readouts*).
- **Freeze Frame**: Use the 4-WAY Cursor Control key to freeze the display and move the cursor over a sonar return. The depth of the sonar return will be displayed in the cursor dialog box.

Split Sonar View (HELIX SONAR)

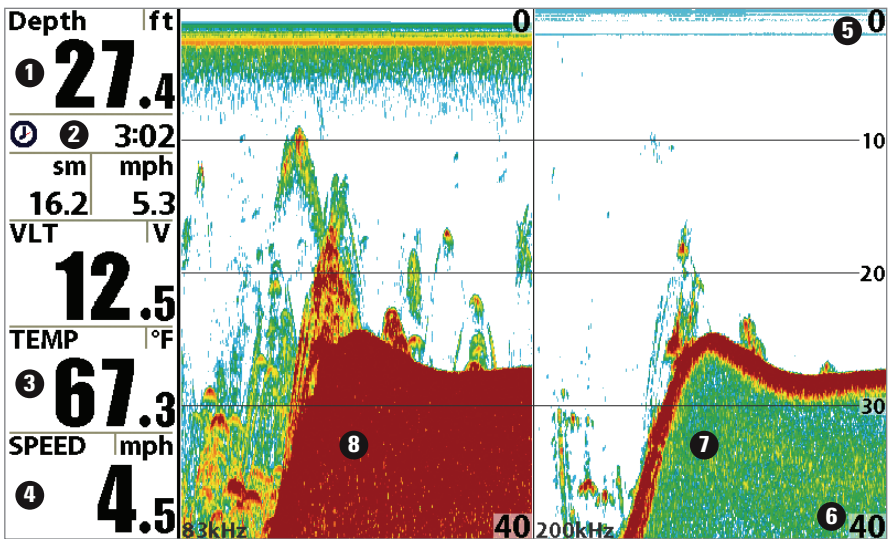

- ① depth
- ② triplog
- ③ temperature
- ④ speed
- ⑤ upper depth range
- ⑥ lower depth range
- ⑦ 200 kHz sonar history window
- ⑧ 83 kHz sonar history window

Big Digits View

Big Digits View provides digital depth data in a large, easy-to-see format.

- **Digital Readouts:** Depth and Temperature are always displayed. The Speed readout is displayed automatically if the appropriate accessory is connected to the Fishfinder.
- The digital readouts in the Big Digits View cannot be customized.

Big Digits View (HELIX SONAR)

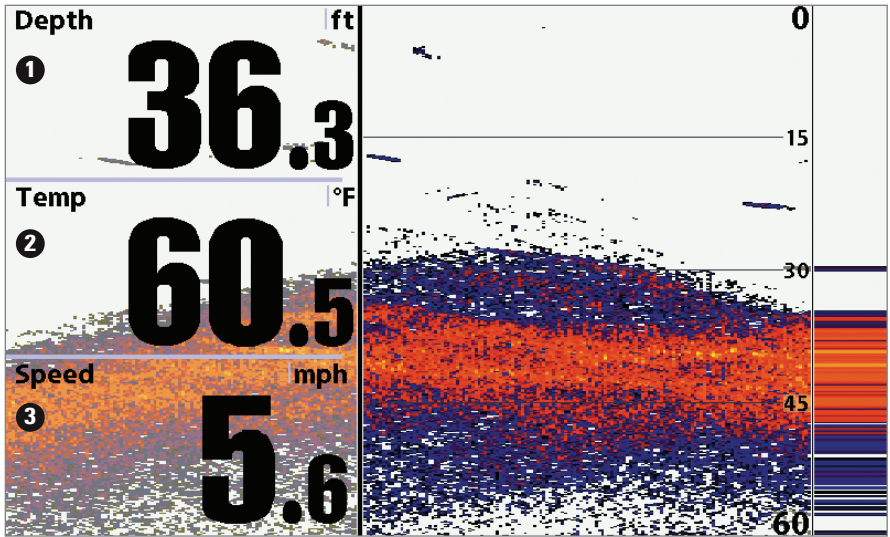

- 1 depth
- 2 temperature
- 3 speed

Down Imaging View

(HELIX DI only)

Down Imaging View uses the razor-thin, high-definition profiling beams to produce the detailed sonar data that you see on the display. Sonar returns are charted on the right side of the display. As new information is received, the historical information scrolls left across the display. See *What's on the Down Imaging Display* for more information.

- **Down Imaging X-Press Menu:** Press the MENU key once to access the Down Imaging X-Press Menu. You can set the sensitivity of the sonar to see more or less detail, the chart scrolling speed, the display color palette, and the Upper Range and Lower Range (see *Down Imaging X-Press Menu*).
- **Freeze Frame:** Press any arrow on the 4-WAY Cursor Control key and the Down Imaging View will freeze and a cursor will appear on the screen. Use the 4-WAY Cursor Control key to move the cursor over a sonar return, and observe the following:
 - The **depth of the sonar return** you choose will be displayed in the cursor information box.
 - **Zoom:** Press the MENU key to open the Down Imaging X-Press Menu and select DI Zoom. Press the LEFT or RIGHT Cursor keys to select the zoom level. A zoom box will appear and magnify the area you choose. The zoom level will appear in the cursor information box. Press EXIT to remove the zoom box and return to Down Imaging View.

Down Imaging View

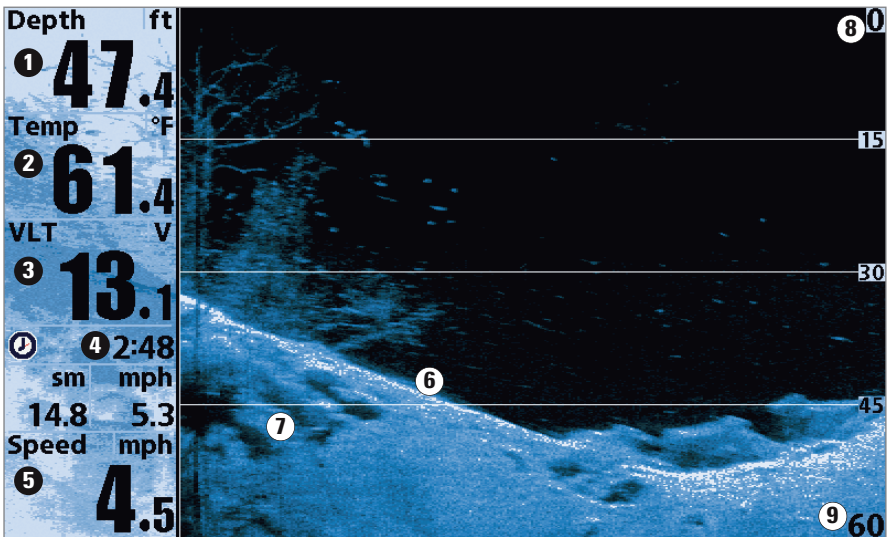

- ① depth
- ② water surface temperature
- ③ voltage
- ④ triolog
- ⑤ speed

- bottom return ⑥
- topography changes ⑦
- upper range ⑧
- lower range ⑨

Down Imaging View with Active Cursor and Zoom

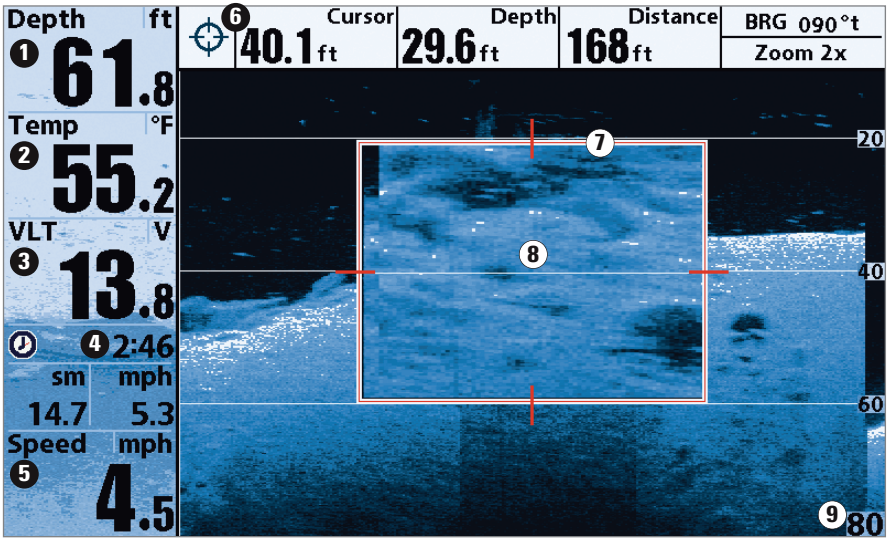

- ① depth
- ② water surface temperature
- ③ voltage
- ④ triplog
- ⑤ speed

- cursor information box ⑥
- zoom magnification box ⑦
- zoomed view ⑧
- lower range ⑨

Circular Flasher View

Circular Flasher View provides two ways to view sonar data in traditional flasher format. The view is controlled by the Ice Fishing Mode menu option in the Sonar Menu Tab.

- **When Ice Fishing Mode is off**, the Circular Flasher View displays Real Time Sonar (RTS) data in a traditional flasher format.
- **When Ice Fishing Mode is on**, the Circular Flasher View displays the sonar data in traditional flasher format with additional features, including Zoom and Depth Cursor.

Set the Circular Flasher View Mode:

1. Press the MENU key twice.
2. Press the RIGHT Cursor key until the Sonar Menu Tab is selected.
3. Press the DOWN Cursor key to select Ice Fishing Mode.
4. Press the RIGHT or LEFT Cursor key to select On or Off (default = Off). See *Sonar Menu Tab* for more information.

Set the Digital Depth Source (HELIX DI only):

If you connect an ice transducer to the control head, set the Digital Depth Source to 2D Element to display depth in the digital readout window. See *Sonar Menu Tab: Digital Depth Source* for more information.

1. Press the MENU key twice.
2. Press the RIGHT Cursor key until the Sonar Menu Tab is selected.
3. Press the DOWN Cursor key to select Digital Depth Source.
4. Press the RIGHT or LEFT Cursor key to select 2D Element.

Ice Fishing Mode: Off

When Ice Fishing Mode is off, the Circular Flasher View displays Real Time Sonar (RTS) data in a traditional flasher format.

- **Flasher X-Press Menu:** Press the MENU key once in the Circular Flasher View. Use the X-Press Menu to set the Sensitivity, Upper Range, and Lower Range.
- **Depth and temperature** are always displayed.
- The **Digital Readouts** cannot be customized.

Circular Flasher View (Ice Fishing Mode: Off)

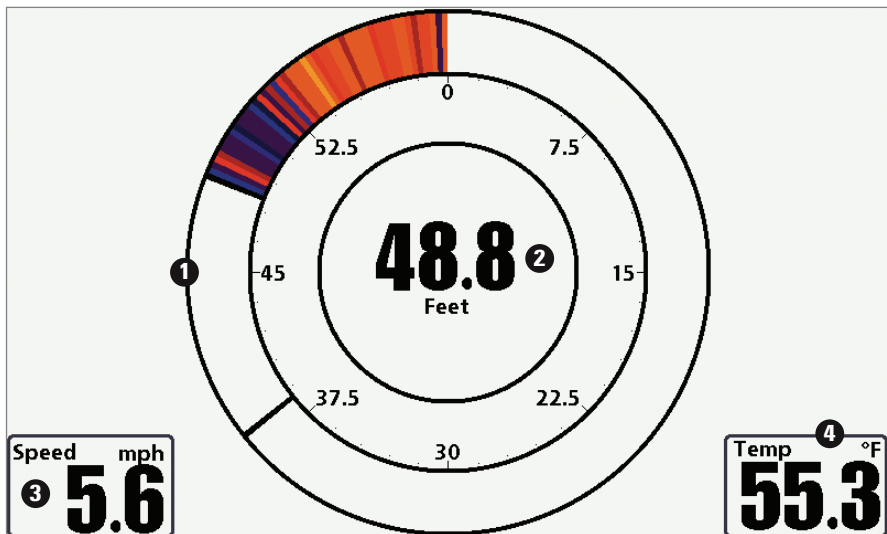

1 flasher dial
2 depth

speed 3
water surface temperature 4

Ice Fishing Mode: On

When **Ice Fishing Mode** is on, the Circular Flasher View displays the sonar data in traditional flasher format with additional features, including Zoom and Depth Cursor.

- **Sensitivity:** When you turn on Ice Fishing Mode, the fishfinder's sensitivity settings are adjusted automatically to accommodate ice fishing conditions. These settings will apply to the other Sonar Views until you turn off Ice Fishing Mode (see *Set the Circular Flasher View Mode* in this section).
- **Flasher X-Press Menu:** Press the MENU key once in the Circular Flasher View. Use the X-Press Menu to set the Sensitivity, Upper Range, Lower Range, and Color Palette.
- **Color Palettes:** The color preview bar in the center of the display indicates the current palette, and the weak to strong sonar return range is displayed from left to right. To change the color palette, see *Flasher X-Press Menu: Color Palette*.
- The **Digital Readouts** cannot be customized.

Circular Flasher View (Ice Fishing Mode: On)

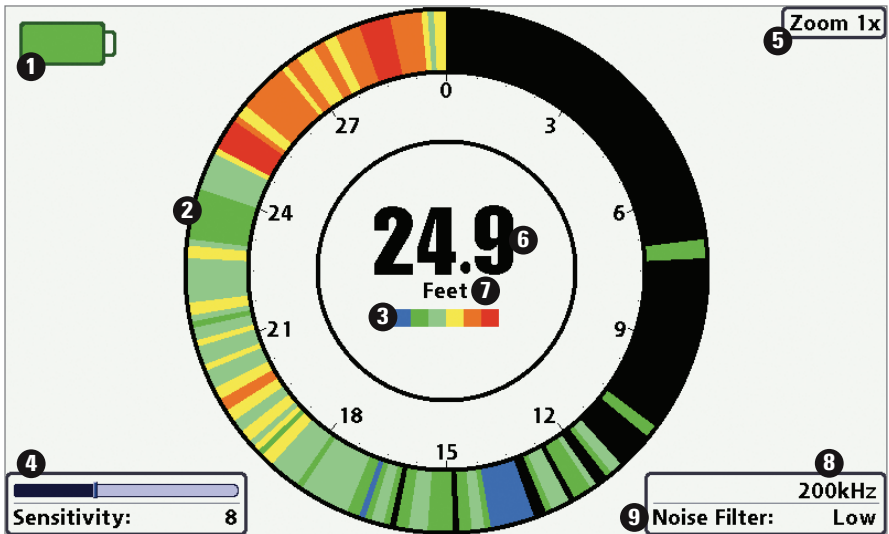

- 1 battery icon indicates the percentage of battery power
- 2 flasher dial
- 3 current color palette
- 4 sensitivity (see Flasher X-Press Menu)
- 5 zoom setting

- 6 depth
- 7 units of measurement
- 8 beam select (see Sonar Menu Tab)
- 9 noise filter (see Sonar Menu Tab)

To activate the Depth Cursor:

Use the Depth Cursor to identify depth on the flasher display.

1. **Set up:** Press the VIEW key repeatedly until the Circular Flasher View is displayed on the screen. Turn on the Ice Fishing Mode (see *Sonar Menu Tab*).
2. **Activate:** Press the DOWN Cursor key, and the purple cursor line will appear on the display.
3. **Adjust the Cursor:** Press the UP or DOWN Cursor keys repeatedly until you reach the chosen depth reading. The depth reading of the cursor is displayed in the top, right corner of the view.
4. **Close the Cursor:** Press the EXIT key.

Circular Flasher View with the Depth Cursor

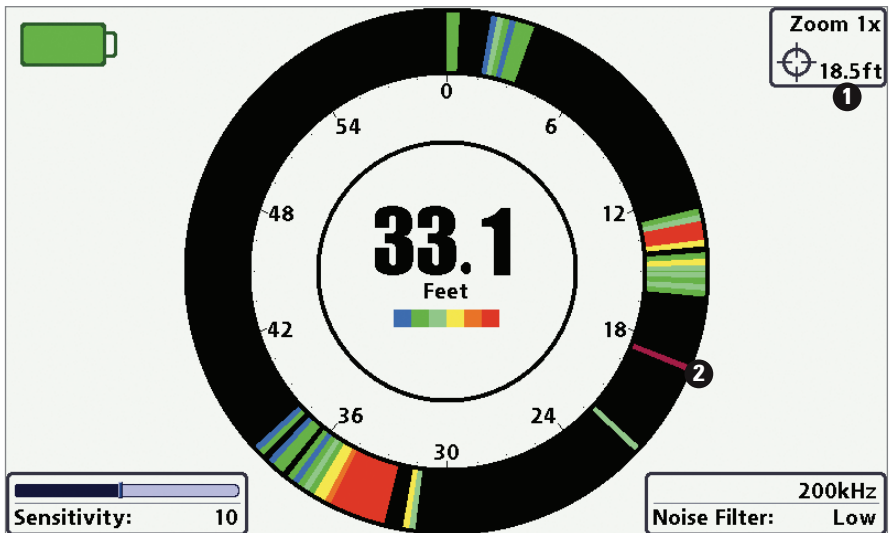

1 depth cursor reading

depth cursor 2

NOTE: See Set the Digital Depth Source for more information.

To activate Flasher Zoom:

The Zoom feature displays a 2x magnified view of the area you choose on the flasher display.

1. **Set up:** Press the VIEW key repeatedly until the Circular Flasher View is displayed on the screen. Turn on the Ice Fishing Mode (see **Sonar Menu Tab**).
2. **Activate:** Press the MENU key. Select Zoom Level from the X-Press Menu, and press the RIGHT Cursor key to select 2X. Zoom upper limit and lower limit lines will appear on the display.
3. **Close the X-Press Menu:** Press the EXIT key.
4. **Adjust the Zoom Range:** Press the RIGHT or LEFT Cursor keys repeatedly to adjust the zoom range and select the area you want to magnify. The zoomed view is shown on the right side of the flasher dial between two lines. The normal view is shown on the left side of the flasher dial.
5. **Close Zoom:** Press the MENU key. Select Zoom Level from the X-Press Menu, and press the LEFT Cursor key to select 1X.

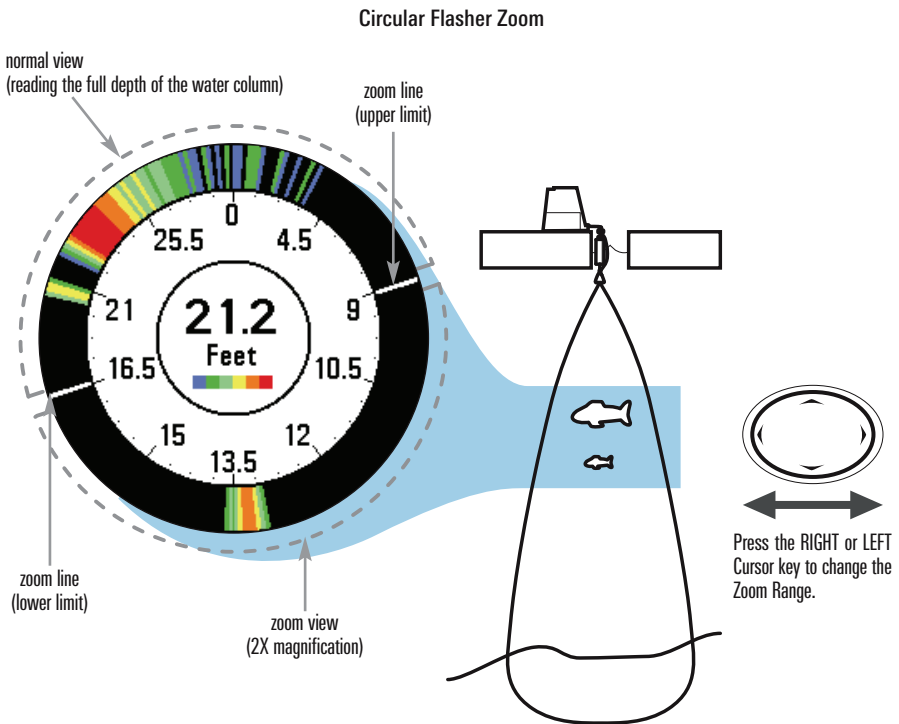

Combo Views

Combo Views display two views (or more) on the screen at the same time. You can perform functions for either side of the view, access the X-Press Menu, and change the left view display size. The available combo views are determined by your Humminbird model.

To change the settings for either side of the view, the individual view must be selected as the active side.

- The **green arrow** points to the active side.
- **Active Side:** Press the MENU key once and select Active Side from the X-Press Menu. Choose RIGHT or LEFT to set the active side.
- **X-Press Menu:** After you set the Active Side, press the MENU key once to access the X-Press Menu. The X-Press Menu provides settings for the active view, and the display updates immediately with your changes.
- **Display Size:** Press the MENU key once and select Split Position from the X-Press Menu. Split Position allows you to adjust the size of the left side of the display.
- **Active Cursor:** Press any arrow on the 4-WAY Cursor Control key, and the cursor will appear on the active side of the view.

Down Imaging/Sonar Combo View

(HELIX DI only)

Down Imaging/Sonar Combo View shows traditional Sonar information on the left and Down Imaging information on the right. For more information about each side of this combo view, see *Down Imaging View* and *Sonar View*.

- **X-Press Menu:** Press the MENU key once to access the Down Imaging X-Press Menu. You can set the sensitivity of the sonar to see more or less detail, the chart scrolling speed, the display color palette, and the Upper Range and Lower Range (see *Down Imaging X-Press Menu*).
- **Freeze Frame:** Press any arrow on the 4-WAY Cursor Control key and the Down Imaging View will freeze and a cursor will appear on the screen. Use the 4-WAY Cursor Control key to move the cursor over a sonar return. The **depth of the sonar return** at the cursor location will be displayed in the cursor information box.

Down Imaging/Sonar Combo View

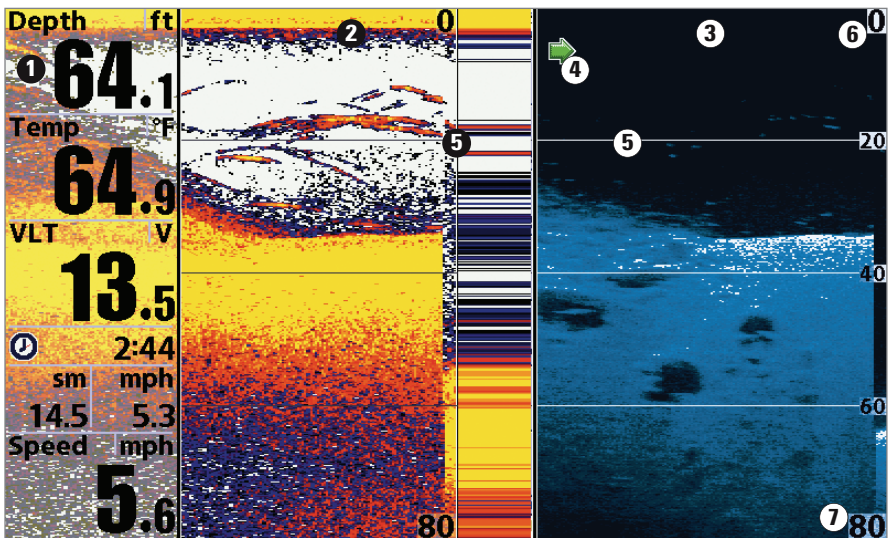

- ① digital readouts
- ② sonar view window
- ③ Down Imaging view window
- ④ green arrow: active side

- ⑤ depth lines
- ⑥ upper depth range
- ⑦ lower depth range

The Menu System

The Menu System is divided into easy-to-use menu modules. The main components of the menu system are as follows:

- **Start-Up Options Menu:** Press the MENU key during the power on sequence to view the Start-Up Options Menu. From the Start-Up Options Menu, you can choose the following Fishfinder Modes: Normal, Simulator, and System Status.
- **X-Press Menu:** The X-Press Menu provides a shortcut to the most frequently-used settings, and the options on the X-Press Menu correspond with the current view.
- **Main Menu:** The Main Menu is a standard set of menu settings which are organized under the following tabbed headings: Alarms, Sonar, and Setup.

***NOTE:** The X-Press Menu(s) and the Main Menu options can also be expanded or simplified by setting the User Mode to Advanced or Normal (see **Main Menu: User Mode**).*

Start-Up Options Menu

Press the MENU key during the power on sequence to view the **Start-Up Options Menu**, and select one of the modes described on the following pages. Also, see *Power On* for more information.

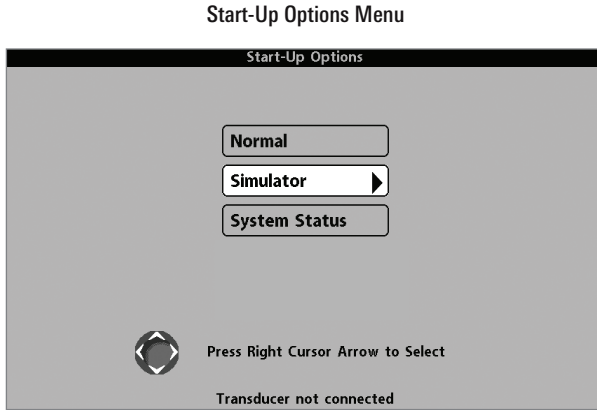

Normal

Use **Normal** for on-the-water operation with a transducer connected. If a functioning transducer is connected, Normal operation will be selected automatically at power up, and your Fishfinder can be used on the water.

To exit Normal operation, power off your Fishfinder.

Simulator

Use **Simulator** to learn how to use your Fishfinder before taking your boat on the water. The Simulator is a very powerful tool that provides a randomly-updated display which simulates on the water operation.

Simulator

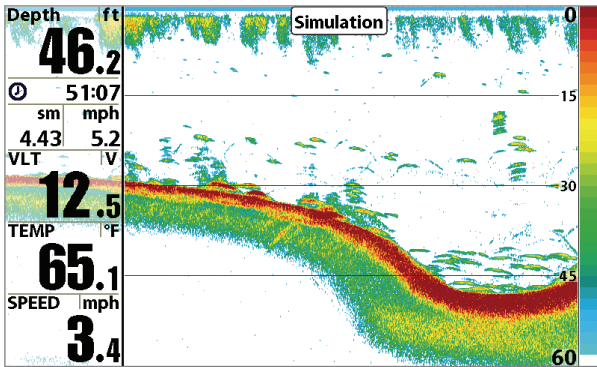

We recommend going through this manual while using the Simulator, since all of the menus function and affect the display in the same way as they would in Normal operation. Any menu changes you make will be saved for later use.

- A **message** will appear often on the display to indicate Simulator mode.
- **To exit Simulator**, power off your Fishfinder.

***NOTE:** It is important to select Simulator manually from the Start-Up Options Menu as opposed to letting the Fishfinder enter Simulator automatically (as it will if a transducer is not connected and you do nothing during power up). See **Power On** for more information.*

System Status

Use **System Status** to view system connections and to conduct a unit self-test.

After you select System Status from the Start-Up Options Menu, press the VIEW key to display the following options:

- Self Test
- Accessory Test

To exit System Status, power off your Fishfinder.

Self Test displays results from the internal diagnostic self test, including unit serial number, Printed Circuit Board (PCB) serial number, software revision, total hours of operation, and the input voltage.

Self Test Screen





Depth	ft	SYSTEM STATUS	
33.3		Self Test	
Temp	°F	PASSED	
56.6		S/N	
VLT	V	2439-138275	MODEL
13.4		HELIX 5 DI	
⌚	2:47	SOFTWARE VERSION	
sm	mph	7.180	
14.7	5.3	VOLTAGE	TOTAL TIME
Speed	mph	13.4^V	2^{hrs}
4.5		PCBS/N	
		-1-0001-001	
		Press VIEW for Next Screen	

Accessory Test lists the accessories connected to the system.

Accessory Test Screen

Depth	ft	SYSTEM STATUS	
52.7		ACCESSORY TEST	
Temp	°F	GPS	CONNECTED
59.2		Speed	CONNECTED
VLT	V	Temperature	CONNECTED
13.1			
⌚	2:45		
sm	mph		
14.6	5.3		
Speed	mph		
4.5			

NOTE: The speed accessory will be detected only if the paddlewheel has moved since your Fishfinder was powered up.

 Sensitivity	10
1  20	
 Upper Range	0ft
 Lower Range	Auto
 Chart Speed	5

X-Press Menu

X-Press Menu

The **X-Press Menu** provides a shortcut to your most frequently-used settings. The options provided on the X-Press Menu correspond with the current view. For example, if you are in a Sonar View and press the MENU key once, the Sonar X-Press Menu will display.

To use an X-Press Menu:

1. In any view, press the MENU key once.
2. Press the UP or DOWN Cursor keys to highlight an X-Press Menu option, then use the RIGHT or LEFT Cursor keys to change the menu setting.

***NOTE:** The X-Press Menu will collapse temporarily and the screen will update if it is affected by your menu setting change, which allows you to see the effects of your change immediately.*

3. Reactivate the X-Press Menu by pressing the UP or DOWN Cursor keys.

Total Screen Update - When you change any menu settings that affect the current view, the view will update immediately (i.e. you don't have to exit the menu to apply the change to the screen).

Menu options can be simplified or expanded by setting the User Mode to Normal or Advanced. See *Main Menu: User Mode* for details.

Alarms	
Depth Alarm	Off
Fish ID Alarm	<input type="radio"/>
Low Battery Alarm	Off
Temp. Alarm	Off
Alarm Tone	Medium
Timer Setup	
Start Timer	
Stop Timer	

Main Menu System
Normal User Mode

Main Menu

The **Main Menu** provides the standard set of menu options, including the settings that are changed less frequently. The Main Menu is organized under the following tabs to help you find a specific menu item quickly: Alarms, Sonar, and Setup.

*NOTE: Menu options can be expanded or simplified by setting the User Mode to Advanced or Normal. See **Main Menu: User Mode** for details.*

To use the Main Menu:

1. In any view, press the MENU key twice.
2. Press the RIGHT or LEFT Cursor keys to highlight a menu tab.
3. Press the DOWN or UP Cursor keys to select a specific menu option under that tab.
4. Press the RIGHT or LEFT Cursor keys again to change a menu setting.
 - A down arrow at the bottom of a menu means that you can scroll to additional menu options using the DOWN Cursor key.
 - A right or left arrow on a menu option means that you can use the RIGHT or LEFT Cursor keys to make changes or to see more information.
 - Press the EXIT key to move quickly to the top of the tab.

Total Screen Update - When you change any menu settings that affect the current view, the view will update immediately (i.e. you don't have to exit the menu to apply the change to the screen).

Quick Tips for the Main Menu

- From any menu option on a menu tab, press the EXIT key to jump directly to the top of the tab.
- From the bottom of a menu tab, press the DOWN Cursor key to jump directly to the top of the tab.
- From the top of a menu tab, press the LEFT or RIGHT Cursor keys to scroll to the next tab. You can also jump to the beginning or end of the tab rotation by repeatedly pressing the RIGHT or LEFT Cursor keys.
- If there is a **down arrow at the bottom of a menu tab**, press the DOWN Cursor key to scroll to additional menu options.
- If there is a **right or left arrow on a menu option**, press the RIGHT or LEFT Cursor keys to make setting changes or see more information.
- If you press MENU or EXIT to leave the Main Menu and then **return to the Main Menu** at a later time, the menu will open to the same tab as the last time the Main Menu was displayed.

Note for all Menu Settings

The settings in all menus are adjusted in the same way. Simply use the 4-WAY Cursor Control key to highlight a menu option, and then change the settings or activate the option (see *Main Menu* or *X-Press Menu*).

Below is an example of how the menu options are described in this manual. Each description shows the menu option appearance, the available settings, and the specific control head settings required (i.e. advanced user mode, international only, view, or accessory).

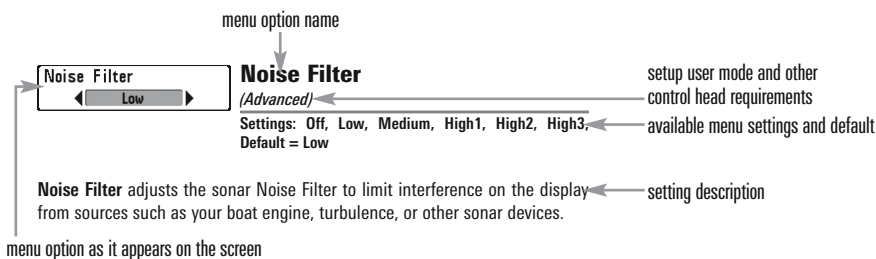

User Mode (Normal or Advanced)

Menu options can be simplified or expanded by setting your Fishfinder User Mode to Normal or Advanced.

Normal Mode is provided for users who want greater simplicity and fewer menu choices.

Advanced Mode is provided for users who want the highest level of control over the Fishfinder. Several menu settings are added to the Main Menu when the User Mode is changed to Advanced.

To change the User Mode setting:

1. Press the MENU key twice to access the Main Menu.
2. Press the RIGHT Cursor key until the Setup tab is selected.
3. Press the DOWN Cursor key to highlight User Mode on the Setup main menu.
4. Press the LEFT or RIGHT Cursor keys to change the User Mode setting. (Normal, Advanced, Default = Advanced)

***NOTE:** Any changes made while in Advanced Mode will remain in effect after you switch back to Normal Mode.*

For example, the Select Readouts menu option is available when the User Mode is set to Advanced. If you change the Select Readouts settings while operating in Advanced User mode, the Select Readouts you choose will continue to display on the screen even if you switch back to Normal User Mode.

Sonar	
Beam Select	200kHz
Imaging Frequency	455kHz
Surface Clutter	5
SwitchFire	Clear Mode
Fish ID +	On
Fish ID Sensitivity	5
RTS Window	Narrow
Sonar Colors	Original Palette
Bottom View	Structure ID
Zoom Width	Narrow
Color Bar	On
Ice Fishing Mode	Off
DI Colors	Blue

Sonar Menu, Normal Mode
(HELIX DI)

Sonar	
Beam Select	200kHz
Imaging Frequency	455kHz
Surface Clutter	5
SwitchFire	Clear Mode
Fish ID +	On
Fish ID Sensitivity	5
RTS Window	Narrow
Sonar Colors	Original Palette
Bottom View	Structure ID
Zoom Width	Narrow
83kHz Sensitivity	0
455kHz Sensitivity	0
Depth Lines	On
Noise Filter	Low
Max Depth	Auto
Water Type	Fresh
Digital Depth Source	Auto
DI Pings	2D + DI
Color Bar	On
Ice Fishing Mode	Off
DI Colors	Blue

Sonar Menu, Advanced Mode
(HELIX DI)

◀▶ Active Side	Left
▶ Split Position	50
🌊 Sensitivity	10
⬅ Upper Range	0ft
➡ Lower Range	Auto
⏏ Chart Speed	5
🔍 Zoom Level	2x
🔒 Bottom Lock	Off
⬅ Bottom Range	15ft

Sonar X-Press Menu

The **Sonar X-Press Menu** provides a shortcut to your most frequently-used settings. Press the MENU key once while in any of the Sonar Views to access the Sonar X-Press Menu.

*NOTE: Menu options can be expanded or simplified by setting the User Mode to Advanced or Normal. See **Main Menu: User Mode** for details.*

NOTE: Menu options are determined by your Humminbird model. See the following pages for full menu descriptions.

Sonar X-Press Menu

Active Side

Active Side

(Combo Views only)

Settings: Left, Right, Default = Left

Active Side allows you to select a side of the screen in a Combo View. After you choose an active side, you can apply menu settings and key commands to the view you've selected. The Active Side menu option is only available when a Combo View is on the screen (see *Views: Combo Views*).

- A green arrow on the Combo View points to the active side.
- When a menu is displayed in the active side, the non-active side of the screen will be grayed out.

Split Position 50
 Left  Right



Split Position

(Combo Views only)

Settings: Left, 30, 40, 50, 60, 70, Right, Default = Various

Split Position sets the size of the left side of the Combo View. Each Combo View can be set individually. The Split Position menu option is only available when a Combo View is on the screen (see *Views: Combo Views*).

- The number setting indicates the percentage taken up by the left side of the Combo View.
- Selecting Left sets the left side of the screen to its smallest setting.

Sensitivity 10
 1  20

Sensitivity

Settings: Low = 1, High = 20; Default = 10

Sensitivity controls how much detail is shown on the display and will adjust the sensitivity of all sonar frequencies.

When operating in very clear water or greater depths, increase the sensitivity to see weaker returns that may be of interest. If the sensitivity is adjusted too high, the display may become too cluttered.

Decrease the sensitivity to eliminate the clutter from the display that is sometimes present in murky or muddy water. If Sensitivity is adjusted too low, the display may not show many sonar returns that could be fish.

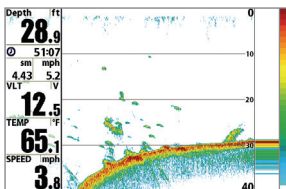

Sensitivity at Low

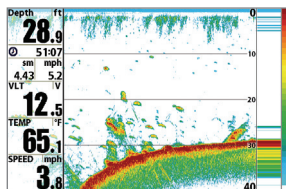

Sensitivity at Medium

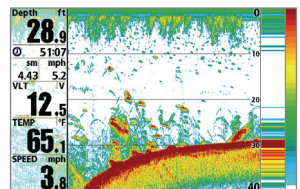

Sensitivity at High

NOTE: The Sensitivity setting is a global setting and will adjust the sensitivity of all sonar frequencies.

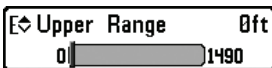

Upper Range

(Advanced: Sonar, Split Sonar, Circular Flasher, Big Digits, and Down Imaging/Sonar Combo Views only)

Settings: Various, see below.

Upper Range sets the shallowest depth range that will be displayed on the Sonar, Split Sonar, Circular Flasher, Big Digits, and Down Imaging/Sonar Combo Views. Upper Range is often used with Lower Range.

For example, if you are only interested in the area between 20 and 50 feet deep, you should set the Upper Depth Range to 20 and the Lower Depth Range to 50. The Sonar View will then show the 30 foot area between 20 and 50, and will not show the surface or the bottom (assuming the bottom is deeper than 50 feet), and will show greater detail for that area between 20 and 50 feet.

NOTE: A minimum distance of 10 feet will be maintained between the Upper and Lower Range regardless of the manual settings entered.

The available Upper Range settings are determined by your Humminbird model as follows:

- **HELIX 5 SONAR:** 0 to 1490 feet or 0 to 454 meters; Default = 0
- **HELIX 5 DI:** 0 to 590 feet or 0 to 180 meters; Default = 0
- **HELIX 7 SONAR:** 0 to 1490 feet or 0 to 454 meters (International Models only); Default = 0
- **HELIX 7 DI:** 0 to 590 feet or 0 to 180 meters (International Models only); Default = 0



Lower Range

Settings: Various, see below.

Lower Range sets the deepest depth range that will be displayed by the unit.

Auto: The Lower Range will be adjusted by the unit to follow the bottom automatically. Auto is the default setting.

Manual: You can adjust the Lower Range to lock the unit on a particular depth. **M** will be displayed in the lower right corner of the screen to indicate the unit is in Manual mode. Adjust the Upper and Lower Range together to view a specific depth range, especially when looking for fish or bottom structure.

For example, if you are fishing in 60 feet of water but are only interested in the first 30 feet (surface to a depth of 30 feet) you should set the Lower Depth Range limit to 30. The display will show the 0 to 30 foot range, which allows you to see a more detailed view than you would see if the display went all the way to the bottom.

NOTE: A minimum distance of 10 feet will be maintained between the Upper and Lower Range regardless of the settings entered manually.

The available Lower Range settings are determined by your Humminbird model as follows:

- **HELIX 5 SONAR:** Auto to 1500 feet or Auto to 457 meters; Default = Auto
- **HELIX 5 DI:** Auto to 600 feet or Auto to 183 meters; Default = Auto
- **HELIX 7 SONAR:** Auto to 1500 feet or Auto to 457 meters (International Models only); Default = Auto
- **HELIX 7 DI:** Auto to 600 feet or Auto to 183 meters (International Models only); Default = Auto

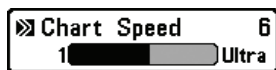
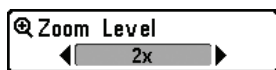

Chart Speed

Settings: 1 to 9, Ultra, where 1 = Slow, 9 = Fast, Ultra = Fastest; Default = 5

Chart Speed determines the speed at which the sonar information moves across the display, and consequently the amount of detail shown.

A **faster speed** shows more information and is preferred by most anglers; however, the sonar information moves across the display quickly. A **slower speed** keeps the information on the display longer, but the bottom and fish details become compressed and may be difficult to interpret. Regardless of the Chart Speed setting, the RTS Window will update at the maximum rate possible for the depth conditions.



Zoom Level

(Sonar Zoom View only)

Settings: 2x, 4x, 6x, 8x; Default = 2x

Zoom Level sets the magnification level for the Sonar Zoom View. Use Zoom to see more detail in the bottom sonar returns that might be displayed close together, such as those caused by fish suspended close to the bottom or within structure.

Zoom Level is only available on the X-Press Menu from the Sonar Zoom View. The Zoom Preview Box shows the section of the bottom that will be magnified.

NOTE: The Zoom Preview Box tracks the bottom and cannot be moved.



Bottom Lock

(Sonar Zoom View only)

Settings: Off, On; Default = Off

Bottom Lock changes the mode of the zoomed view in the Sonar Zoom View. Bottom Lock continuously graphs the bottom at a constant point on the display regardless of changes in depth. This "flattens" out the bottom contour but is effective at showing fish on or near the bottom.



Bottom Range

(Sonar Zoom View only, when Bottom Lock is On)







Settings: Various, see below.

Bottom Range allows you to control how much of the water column, measured up from the bottom, is shown in the Sonar Zoom View. Choose a small value to see low-lying bottom structure or details of the bottom return. Choose a larger value to see large structure in deeper water.

***NOTE:** It is possible to set the Bottom Range to be greater than the depth. In this case, you may see surface clutter in a wavy band that mirrors changes in the depth.*

The available Bottom Range settings are determined by your Humminbird model as follows:

- **HELIX 5:** 10 to 60 feet or 3 to 20 meters; Default = 15 feet
- **HELIX 7:** 10 to 60 feet or 3 to 20 meters (International Models only); Default = 15 feet

 Down Sensitivity	10
1  20	
 DI Enhance	
 Upper Range	0ft
 Lower Range	Auto
 Chart Speed	10
 DI Colors	Blue

Down Imaging X-Press Menu

Down Imaging X-Press Menu

(Down Imaging Views only [HELIX DI only])

The **Down Imaging X-Press Menu** provides a shortcut to your most frequently-used settings. Press the MENU key once while in any of the Down Imaging Views to access the Down Imaging X-Press Menu.

NOTE: Menu options can be expanded or simplified by setting the User Mode to Advanced or Normal. See **Main Menu: User Mode** for details.

NOTE: Menu options are determined by your Humminbird model. See the following pages for full menu descriptions.



Active Side

(Combo Views only)

Settings: Left, Right, Default = Left

Active Side allows you to select a side of the screen in a Combo View. After you choose an active side, you can apply menu settings and key commands to the view you've selected. The Active Side menu option is only available when a Combo View is on the screen (see *Views: Combo Views*).

- A green arrow on the Combo View points to the active side.
- When a menu is displayed in the active side, the non-active side of the screen will be grayed out.



Split Position

(Combo Views only)

Settings: Left, 30, 40, 50, 60, 70, Right, Default = Various

Split Position sets the size of the left side of the Combo View. Each Combo View can be set individually. The Split Position menu option is only available when a Combo View is on the screen (see *Views: Combo Views*).

- The number setting indicates the percentage taken up by the left side of the Combo View.
- Selecting Left sets the left side of the screen to its smallest setting.



Down Sensitivity

Settings: 1 to 20, where Low = 1, High = 20; Default = 10

Down Sensitivity controls how the sonar returns are displayed on the Down Imaging Views.

Increase the Down Sensitivity to reveal weaker returns that may be of interest, especially in very clear water or greater depths. A high Down Imaging Sensitivity setting shows more sonar returns from small baitfish and suspended debris in the water; however if the Down Imaging Sensitivity is adjusted too high, the display may become too cluttered.

Decrease the Down Sensitivity to eliminate the clutter from the display that is sometimes present in murky or muddy water. If Down Imaging Sensitivity is adjusted too low, the display may not show many sonar returns that could be fish.

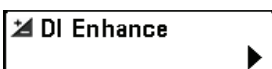

DI Enhance

Settings: Press the RIGHT Cursor key.

DI Enhance allows you to adjust your Down Imaging View in the following categories: Sensitivity, Contrast, and Sharpness.

Whether you're searching the Down Imaging data for fish or certain bottom contour, the most effective settings will vary with the situation. The display will update as you adjust each category.

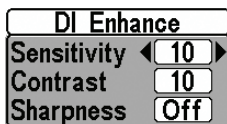

DI Enhance Submenu

- **Sensitivity:** Controls how much detail is shown on the display. When operating in very clear water or greater depths, increased sensitivity shows weaker returns that may be of interest. Decreasing the sensitivity eliminates the clutter from the display that is sometimes present in murky or muddy water. (**1 to 20, where Low = 1, High = 20; Default = 10**)

*NOTE: The Sensitivity can be adjusted from the DI Enhance dialog box or the Down Imaging X-Press Menu. The Sensitivity setting is provided here so that you can easily adjust the Down Imaging data with the other settings. See **Down Imaging X-Press Menu: Down Sensitivity** for more information.*

- **Contrast:** Accents the light and dark parts of the Down Imaging data to provide greater definition. (**1 to 20, Default = 10**)
- **Sharpness:** Filters the view and sharpens the edges of the Down Imaging data. (**Off, Low (L), Medium (M), High (H), Default = Off**)

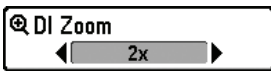

DI Zoom

(with active cursor only)

Settings: Off, 2x, 4x, 6x; Default = Off

DI Zoom sets the magnification level for the Down Imaging View. Use DI Zoom to see more detail in the bottom sonar returns that might be displayed close together, such as those caused by fish suspended close to the bottom or within structure.

*NOTE: The cursor must be active for the DI Zoom feature to work in the Down Imaging View. See **Views: Down Imaging View** for more information.*

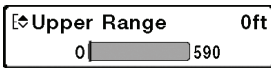

Upper Range

(Advanced)

Settings: Various, see below.

Upper Range sets the shallowest depth range that will be displayed on the Down Imaging Views. Upper Range is often used with Lower Range.

For example, if you are only interested in the area between 20 and 50 feet deep, you should set the Upper Depth Range to 20 and the Lower Depth Range to 50. The Down Imaging View will then show the 30 foot area between 20 and 50, and will not show the surface or the bottom (assuming the bottom is deeper than 50 feet), and will show greater detail for that area between 20 and 50 feet.

NOTE: A minimum distance of 10 feet will be maintained between the Upper and Lower Range regardless of the manual settings entered.

The available Upper Range settings are determined by your Humminbird model as follows:

- **HELIX 5 DI:** 0 to 590 feet or 0 to 180 meters; Default = 0
- **HELIX 7 DI:** 0 to 590 feet or 0 to 180 meters (International Models only); Default = 0

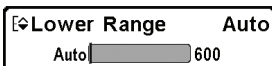

Lower Range

Settings: Various, see below.

Lower Range sets the deepest depth range that will be displayed by the unit.

Auto: The Lower Range will be adjusted by the unit to follow the bottom automatically. Auto is the default setting.

Manual: You can adjust the Lower Range to lock the unit on a particular depth. **M** will be displayed in the lower right corner of the screen to indicate the unit is in Manual mode. Adjust the Upper and Lower Range together to view a specific depth range, especially when looking for fish or bottom structure.

For example, if you are fishing in 60 feet of water but are only interested in the first 30 feet (surface to a depth of 30 feet) you should set the Lower Depth Range limit to 30. The display will show the 0 to 30 foot range, which allows you to see a more detailed view than you would see if the display went all the way to the bottom.

***NOTE:** A minimum distance of 10 feet will be maintained between the Upper and Lower Range regardless of the settings entered manually.*

The available Lower Range settings are determined by your Humminbird model as follows:

- **HELIX 5 DI:** Auto to 600 feet or Auto to 183 meters; Default = Auto
- **HELIX 7 DI:** Auto to 600 feet or Auto to 183 meters (International Models only); Default = Auto

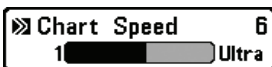

Chart Speed

Settings: 1 to 9, Ultra, where 1 = Slow, 9 = Fast, Ultra = Fastest; Default = 5

Chart Speed determines the speed at which the sonar information moves across the display, and consequently the amount of detail shown.

A **faster speed** shows more information and is preferred by most anglers; however, the sonar information moves across the display quickly. A **slower speed** keeps the information on the display longer, but the bottom and fish details become compressed and may be difficult to interpret.



DI Colors

Settings: Blue, Amber 1, Amber 2, Brown, Green, Inverse, Gray, Green/Red; Default = Amber 1

DI Colors allows you to select which color palette you would like to use for the Down Imaging display.

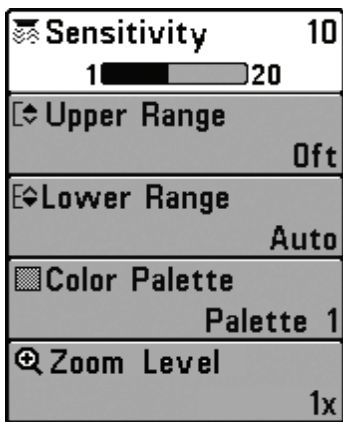

Flasher X-Press Menu

Flasher X-Press Menu

(Circular Flasher View only)

The **Flasher X-Press Menu** provides a shortcut to your most frequently-used settings. Press the MENU key once while in the Circular Flasher View to access the Flasher X-Press Menu.

*NOTE: Menu options can be expanded or simplified by setting the User Mode to Advanced or Normal. See **Main Menu: User Mode** for details.*

NOTE: Menu options are determined by your Humminbird model. See the following pages for full menu descriptions.

*NOTE: To activate Ice Fishing Mode, see **Sonar Menu Tab**.*



Sensitivity

Settings: Low = 1, High = 20; Default = 10

Sensitivity controls how much detail is shown on the display and will adjust the sensitivity of all sonar frequencies.

When operating in very clear water or greater depths, increase the sensitivity to see weaker returns that may be of interest. If the sensitivity is adjusted too high, the display may become too cluttered.

Decrease the sensitivity to eliminate the clutter from the display that is sometimes present in murky or muddy water. If Sensitivity is adjusted too low, the display may not show many sonar returns that could be fish.

***NOTE:** The Sensitivity setting is a global setting and will adjust the sensitivity of all sonar frequencies.*



Upper Range

(Advanced)

Settings: Various, see below.

Upper Range sets the shallowest depth range that will be displayed on the Sonar, Split Sonar, Circular Flasher, Big Digits, and Down Imaging/Sonar Combo Views. Upper Range is often used with Lower Range.

For example, if you are only interested in the area between 20 and 50 feet deep, you should set the Upper Depth Range to 20 and the Lower Depth Range to 50. The Sonar View will then show the 30 foot area between 20 and 50, and will not show the surface or the bottom (assuming the bottom is deeper than 50 feet), and will show greater detail for that area between 20 and 50 feet.

***NOTE:** A minimum distance of 10 feet will be maintained between the Upper and Lower Range regardless of the manual settings entered.*

The available Upper Range settings are determined by your Humminbird model as follows:

- **HELIX 5 SONAR:** 0 to 1490 feet or 0 to 454 meters; Default = 0
- **HELIX 5 DI:** 0 to 590 feet or 0 to 180 meters; Default = 0
- **HELIX 7 SONAR:** 0 to 1490 feet or 0 to 454 meters (International Models only); Default = 0
- **HELIX 7 DI:** 0 to 590 feet or 0 to 180 meters (International Models only); Default = 0



Lower Range

Settings: Various, see below.

Lower Range sets the deepest depth range that will be displayed by the unit.

Auto: The Lower Range will be adjusted by the unit to follow the bottom automatically. Auto is the default setting.

Manual: You can adjust the Lower Range to lock the unit on a particular depth. **M** will be displayed in the lower right corner of the screen to indicate the unit is in Manual mode. Adjust the Upper and Lower Range together to view a specific depth range, especially when looking for fish or bottom structure.

For example, if you are fishing in 60 feet of water but are only interested in the first 30 feet (surface to a depth of 30 feet) you should set the Lower Depth Range limit to 30. The display will show the 0 to 30 foot range, which allows you to see a more detailed view than you would see if the display went all the way to the bottom.

NOTE: A minimum distance of 10 feet will be maintained between the Upper and Lower Range regardless of the settings entered manually.

The available Lower Range settings are determined by your Humminbird model as follows:

- **HELIX 5 SONAR:** Auto to 1500 feet or Auto to 457 meters; Default = Auto
- **HELIX 5 DI:** Auto to 600 feet or Auto to 183 meters; Default = Auto
- **HELIX 7 SONAR:** Auto to 1500 feet or Auto to 457 meters (International Models only); Default = Auto.
- **HELIX 7 DI:** Auto to 600 feet or Auto to 183 meters (International Models only); Default = Auto



Color Palette

(Circular Flasher View, Ice Fishing Mode only)

Settings: Palette 1, Palette 2, Palette 3; Default = Palette 3

Color Palette sets the colors used to display sonar returns in the Circular Flasher View when Ice Fishing Mode is turned on. The active color palette is shown in the center of the circular flasher display. The color palettes range from weak to strong sonar return signals, which are displayed left to right on the color preview bar. See **Views: Circular Flasher View** for more information.

Choose from the following color palettes:

Palette 1: Green (weak), Yellow (medium), Red (strong)

Palette 2: Yellow (weak), Green (medium), Red (strong)

Palette 3: Blue (weakest), Green (weak), Light Green (weak to medium), Yellow (medium), Orange (fairly strong), Red (strong)

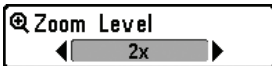

Zoom Level

(Circular Flasher View, Ice Fishing Mode only)

Settings: 1x, 2x; Default = 1x

Zoom Level sets the magnification level for the Circular Flasher View when Ice Fishing Mode is turned on. When the Zoom Level is set to 1x, the Zoom feature is turned off.

When the Zoom Level is set to 2x, the Circular Flasher View displays a 2x magnified view of the area you choose. The zoomed view is shown on the right side of the flasher dial between two lines. The normal view is shown on the left side of the flasher dial. The Zoom Range can be adjusted with the RIGHT and LEFT Cursor key. See **Views: Circular Flasher View** for more information.

Alarms Menu Tab

Depth Alarm	Off
Fish ID Alarm	
Low Battery Alarm	Off
Temp. Alarm	Off
Alarm Tone	Medium
Timer Setup	
Start Timer	
Stop Timer	

From any view, press the MENU key twice to access the Main Menu System. The Alarms tab will be the default selection.

NOTE: When an alarm is triggered, you can silence it by pressing any key. The alarm will be silenced, and will not be triggered again until a new instance of the alarm condition is detected.

*NOTE: Menu options can be expanded or simplified by setting the User Mode to Advanced or Normal. See **Main Menu: User Mode** for details.*

Alarms Menu

Depth Alarm Off
Off

Depth Alarm

Settings: Various, see below.

Depth Alarm sounds when the depth becomes equal to or less than the menu setting.

- **HELIX 5:** Off, 1 to 100 feet, or 0.5 to 30 meters; Default = Off
- **HELIX 7:** Off, 1 to 100 feet, or 0.5 to 30 meters (International Models only); Default = Off

Fish ID Alarm

Fish ID Alarm

Settings: Off, All, Large/Medium, Large; Default = Off

Fish ID Alarm sounds when the Fishfinder detects fish that correspond to the alarm setting. Fish ID Alarm will only sound if Fish ID+ is on.

For example, if you've set the Fish ID Alarm to sound for Large fish only, the Fish ID alarm will sound when a large-sized fish is detected.

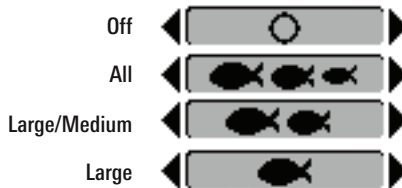

Low Battery Alarm Off
Off

Low Battery Alarm

Settings: Off, 8.5V - 13.5V; Default = Off

Low Battery Alarm sounds when the input battery voltage is equal to or less than the menu setting. The battery alarm will only sound for the battery that is connected to the Fishfinder. The Low Battery Alarm should be set to warn you when the battery voltage drops below the safety margin that you have determined.

For example, if you are running a trolling motor (battery operated), you would want to set the Low Battery Alarm to sound before the battery voltage drops too low for it to be used to start your main, gasoline-powered engine.

Temp. Alarm Off
Off

Temp. Alarm

Settings: Off, 33 - 120 Fahrenheit, 0 - 50 Celsius [International Models only]; Default = Off

Temp. Alarm sounds when the water temperature detected by the Fishfinder reaches the Temp. Alarm setting, which is either set in degrees Fahrenheit or Celsius [International models only].

For example, if the Temp. Alarm is set to 58 degrees Fahrenheit, and the water temperature falls from 60 degrees to 58 degrees, the Temp. Alarm will sound. Similarly, if the water temperature rises from 56 degrees to 58 degrees, the Temp. Alarm will also sound.

Alarm Tone

◀ Medium ▶

Alarm Tone

Settings: High, Medium, Low; Default = Medium

Alarm Tone selects the pitch of the alarm sound. A brief tone will be produced as you adjust the Alarm Tone so that you can select the tone that you can hear best.

Timer Setup



Timer Setup

Settings: Press the RIGHT Cursor key to open the dialog box.

Timer Setup allows you to open a dialog box to create settings for the Timer. You can also start the countdown from this dialog box. When the Timer is started, the clock counts down from the amount of time set in the dialog box.

Timer			
	hr	min	sec
Time ▶	02	: 15	: 23
Save and Start ▶			
Save and Close ▶			

- **Time:** Use the 4-WAY Cursor Control key to set the hours, minutes, and seconds.
- **Save and Start:** To start the Timer immediately, select Save and Start, and press the RIGHT Cursor key.
- **Save and Close:** To save your settings and start the Timer at a later time, select Save and Close, and press the RIGHT Cursor key. Also, see *Start Timer*.
- **Digital Readout:** To display the Timer on-screen as it counts down, see *Views: To Change the Digital Readouts*.

Start Timer



Start Timer

Settings: Press the RIGHT Cursor key to start the Timer.

Start Timer allows you to start the Timer using the saved countdown settings in the Timer Setup dialog box. To create the Timer settings, see *Timer Setup*.

Stop Timer



Stop Timer

(with the Timer running)

Settings: Press the RIGHT Cursor key to stop the Timer.

Stop Timer allows you to stop the Timer while it is counting down.

(4)	Sonar	5
Beam Select		200kHz
Imaging Frequency		455kHz
Surface Clutter		5
SwitchFire	Clear Mode	
Fish ID +		On
Fish ID Sensitivity		5
RTS Window		Narrow
Sonar Colors		Original Palette
Bottom View		Structure ID
Zoom Width		Narrow
83kHz Sensitivity		0
455kHz Sensitivity		0
Depth Lines		On
Noise Filter		Low
Max Depth		Auto
Water Type		Fresh
Digital Depth Source		Auto
DI Pings		2D + DI
Color Bar		On
Ice Fishing Mode		Off
DI Colors		Blue

Sonar Menu Tab

Press the MENU key twice to access the Main Menu and then press the RIGHT Cursor key until the Sonar tab is selected.

*NOTE: Menu options can be expanded or simplified by setting the User Mode to Advanced or Normal. See **Main Menu: User Mode** for details.*

NOTE: Menu options are determined by your Humminbird model. See the following pages for full menu descriptions.

Sonar Menu, Advanced Mode
(HELIX DI)

Beam Select sets which sonar returns from the transducer will be displayed on the screen. The available beam frequencies are determined by your Humminbird model.

HELIX SONAR models allow you to choose 200/83 kHz, 200 kHz, or 83 kHz (default = 200 kHz).

- When set to **200/83 kHz**, the returns from both beams are blended by starting with the 83 kHz wide beam return, dimming it, and then overlaying it with the 200 kHz narrow beam return. The darker 200 kHz narrow beam sonar returns will stand out from the paler 83 kHz wide beam sonar returns. The Split Sonar View continues to display the sonar returns from each beam in their respective windows. The blended information is shown in the Sonar View, Sonar Zoom View, and the Big Digits View. The RTS Window in the Sonar View and the Circular Flasher View will only show the returns from the 200 kHz narrow beam.
- When set to **200 kHz**, only the returns from the 200 kHz narrow beam will be displayed in the Sonar View, the Sonar Zoom View, the Big Digits View, and the Circular Flasher View. The Split Sonar View will continue to display returns from both beams in their respective windows. The RTS Window in the Sonar View will display the returns from the 200 kHz narrow beam.
- When set to **83 kHz**, the returns from the 83 kHz wide beam will be displayed in the Sonar View, the Sonar Zoom View, the Big Digits View, and the Circular Flasher View. The Split Sonar View will continue to display returns from both beams in their respective windows. The RTS Window will display the returns from the 83 kHz wide beam.

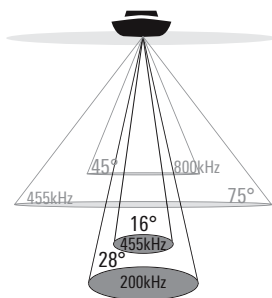

HELIX DI models allow you to choose 200 kHz or 455 kHz for conical sonar coverage in the traditional sonar views.

- When set to **200 kHz**, only the returns from the 200 kHz (28°) beam will be displayed.
- When set to **455 kHz**, only the returns from the 455 kHz (16°) narrow beam will be displayed.

Imaging Frequency

455kHz

Imaging Frequency

(Down Imaging Views only [HELIX DI only])

Settings: 800 kHz, 455 kHz; Default = 455 kHz

Imaging Frequency allows you to select which frequency to apply to the Down Imaging beams (455 kHz or 800 kHz). For the best overall image quality and depth, select 455 kHz. For the sharpest image (but limited depth capability), select 800 kHz.

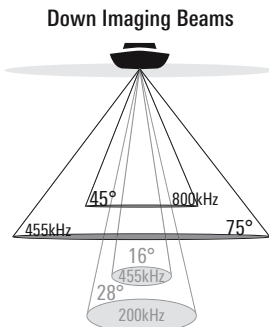

Surface Clutter

1 5 10

Surface Clutter

Settings: Low = 1 to High = 10; Default = 5

Surface Clutter adjusts the filter that removes surface clutter noise caused by algae and aeration. The lower the setting, the less surface clutter will be displayed.

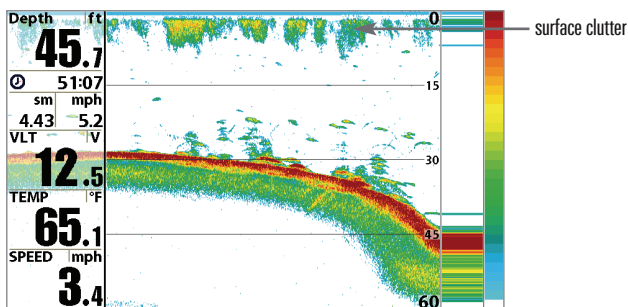

SwitchFire

◀ Clear Mode ▶

SwitchFire

Settings: Max Mode, Clear Mode; Default = Clear Mode

SwitchFire controls how the sonar returns are displayed in the Sonar Views.

Choose **Max Mode** to see only raw sonar returns on the display. When Max Mode is selected, you will see the maximum sonar information available within the transducer beam, so more fish arches and better jig tracking are shown.

Choose **Clear Mode** to see less clutter and more fish size accuracy on the display. When Clear Mode is selected, the clutter is filtered, and sonar returns are interpreted to provide more details about the objects within the transducer beam, regardless of their location. In other words, a large arch on the display means a large fish has been detected.

Fish ID +

◀ Off ▶

Fish ID+

Settings: Off, On; Default = Off

Fish ID+ uses advanced signal processing to interpret sonar returns and will display a Fish Symbol when very selective requirements are met. When a fish is detected, a fish icon and its depth are displayed above the return that has been classified as being a fish. Three different fish size icons represent the intensity of the sonar return and provide an indicator of relative fish size.

In **HELIX SONAR models**, targets detected in the 200 kHz narrow beam are represented as orange fish symbols, and targets detected in the 83 kHz wide beam are represented as blue fish symbols.



orange fish symbols



blue fish symbols

In **HELIX DI models**, targets detected in the 455 kHz conical beam are represented as blue fish symbols, and targets detected in the 200 kHz conical beam are represented as orange fish symbols.

When Fish ID+ is turned off, the Fishfinder shows only the raw sonar returns on the display. These returns will often result in “arches” forming on the display, indicating potential targets. Due to the transducer beam angle, the distance to a fish decreases as the fish moves into the beam, and then increases as it moves out again, creating a Fish Arch when this distance change is shown on the display. Boat speed, chart speed, and the position of the fish within the sonar beam greatly affect the shape of the arch.

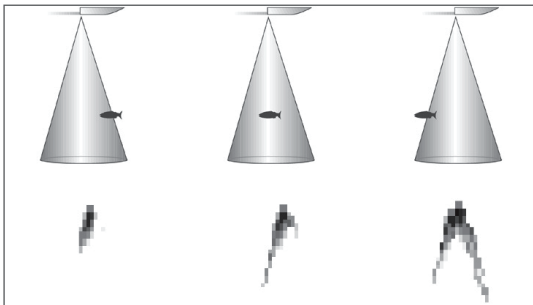

Transducer Cone and Fish Arches

Fish ID Sensitivity

5

1  10

Fish ID Sensitivity

Settings: Low = 1, High = 10; Default = 5

Fish ID Sensitivity adjusts the threshold of the Fish ID+ detection algorithms. Selecting a higher setting allows weaker returns to be displayed as fish. This is useful for identifying smaller fish species or baitfish. Selecting a lower setting displays fewer fish from weak sonar returns. This is helpful when seeking larger species of fish.

Fish ID Sensitivity is used in conjunction with Fish ID+. Fish ID+ must be On for Fish ID Sensitivity to affect the ability of the Fishfinder to identify sonar returns as fish.

RTS Window

◀ Narrow ▶

Real Time Sonar (RTS) Window

Settings: Wide, Narrow, Off; Default = Narrow

RTS Window sets the RTS Window to Wide or Narrow, or turns it off in the Sonar View. The RTS Window always updates at the fastest rate possible and only displays returns that are within the transducer beam. See *What's on the Sonar Display* for more information.

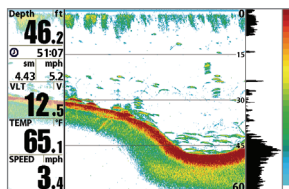

RTS Window (Wide)

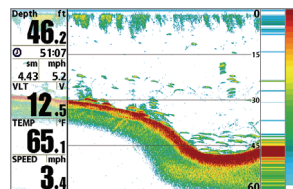

RTS Window (Narrow)

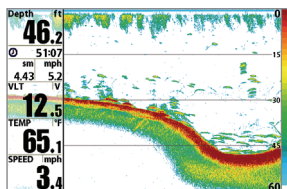

RTS Window (Off)

NOTE: The Wide RTS Window does not use grayscale.

Sonar Colors

◀ Original Palette ▶

Sonar Colors

Settings: Gray, Green, Inverse, Original Palette, Palette 1, Palette 2, Palette 3; Default = Palette 1

Sonar Colors allows you to select which color palette you would like to use for the display. The palette you choose will be applied to the Sonar Views.

- **Gray:** Light Gray (weak) to Black (strong)
- **Green:** Dark Green (weak) to Light Green (strong)
- **Inverse:** Black (weak) to White (strong)
- **Original Palette:** Cyan (weak) to Red (strong)
- **Palette 1:** Navy Blue (weak), Purple (medium), Yellow (strong)
- **Palette 2:** Navy Blue (weak), Green (medium), Yellow (strong)
- **Palette 3:** Navy Blue (weak) to Red (strong)

*NOTE: To change the color palette for the Circular Flasher View, see **Flasher X-Press Menu: Color Palette**.*

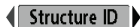
Bottom View**Bottom View**

Settings: Structure ID, WhiteLine; Default = Structure ID

Bottom View selects the method used to represent bottom and structure on the display.

- **Structure ID** represents weak returns in blue and strong returns in red. If the Sonar Colors palette is changed, the Structure ID will display the strongest return as specified by the palette.
- **WhiteLine** highlights the strongest sonar returns in white, resulting in a distinctive outline. This has the benefit of clearly defining the bottom on the display.

See *What's on the Sonar Display: Sonar Colors and Bottom View* for more information.

Zoom Width**Zoom Width**

(Sonar Zoom View only)

Settings: Narrow, Medium, Wide; Default = Narrow

Zoom Width adjusts the width of the zoomed view on the Sonar Zoom View, which is on the left side of the display. See *Views: Sonar Zoom View* for more information.

**83 kHz Sensitivity**

(Advanced, DualBeam PLUS Sonar only [HELIX SONAR only])

Settings: -10 to +10, Default = 0

83 kHz Sensitivity changes the sensitivity of the 83 kHz beam. Increasing the 83 kHz Sensitivity will display additional weak returns, and decreasing the 83 kHz Sensitivity will display fewer weak returns.

NOTE: 83 kHz Sensitivity is particularly useful for adjusting the sensitivity of the 83 kHz sonar returns in the 200/83kHz Split Sonar View. The 83 kHz sensitivity can be adjusted without affecting the sensitivity of the 200 kHz returns shown in the 200 kHz sonar window.

**455 kHz Sensitivity**

(Advanced, Down Imaging Views only [HELIX DI only])

Settings: -10 to +10, Default = 0

455 kHz Sensitivity adjusts the sensitivity of the 455 kHz beam. Increase the sensitivity to display additional weak returns and decrease the sensitivity to display fewer weak returns.

Depth Lines
◀ On ▶

Depth Lines

(Advanced)

Settings: Off, On; Default = On

Depth Lines divide the display into four equal sections which are separated by three horizontal depth lines. The depth of each line is displayed along the depth scale. You can turn Depth Lines On or Off.

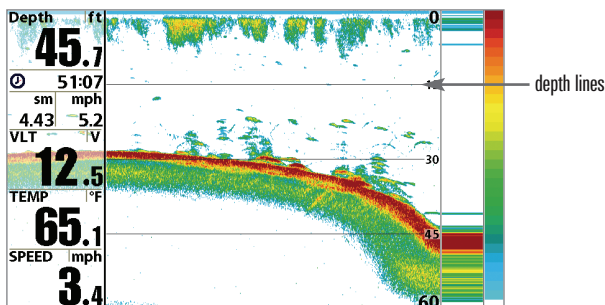

Noise Filter
◀ Off ▶

Noise Filter

(Advanced)

Settings: Off, Low, Medium, High 1, High 2, High 3; Default = Low

Noise Filter adjusts the sonar Noise Filter to limit interference on the display from sources such as your boat engine, turbulence, or other sonar devices.

The Off setting removes all filtering. Low, Medium, and High 1, High 2, High 3 settings add progressive filtering of the sonar returns. High 1, High 2, and High 3 are useful when there is excessive trolling motor noise, but in some deep water situations, the High settings may actually hinder your unit's ability to find the bottom.

Max Depth Auto
Auto 1500

Max Depth

(Advanced)

Settings: Various, see below.

Max Depth controls the maximum depth of operation. When Max Depth is set to Auto, the Fishfinder will acquire bottom readings as needed (within the capacity of the unit). When Max Depth is set to match your fishing maximum depth, your Fishfinder will not attempt to acquire sonar data below that depth, so more detail will be shown on the screen.

***NOTE:** If the bottom is deeper than the Max Depth setting, the digital depth readout will flash, indicating that the Fishfinder cannot locate the bottom.*

- **HELIX 5 SONAR:** Auto to 1500 feet or Auto to 457 meters; Default = Auto
- **HELIX 5 DI:** Auto to 600 feet or Auto to 183 meters; Default = Auto
- **HELIX 7 SONAR:** Auto to 1500 feet or Auto to 457 meters (International Models only); Default = Auto
- **HELIX 7 DI:** Auto to 600 feet or Auto to 183 meters (International Models only); Default = Auto

Water Type

◀ Fresh ▶

Water Type

(Advanced)

Settings: Fresh, Salt (shallow), Salt (deep); Default = Fresh

Water Type configures your unit for operation in fresh or salt water. In salt water, you can also choose the shallow or deep setting.

***NOTE:** Make sure that the Water Type is set accurately, especially in salt water, as this affects the accuracy of deep water depth readings. In salt water, what would be considered a large fish might be 2 to 10 times bigger than a large fish in fresh water (depending on the type of fish you are seeking). The salt water setting allows for a greater range in fish size adjustment to account for this difference.*

Digital Depth Source

◀ Auto ▶

Digital Depth Source

(Advanced, HELIX DI with optional-purchase transducers only)

Settings: Auto, 2D Element; Default = Auto

Digital Depth Source specifies the beams that will be used to provide the depth for the digital depth readouts (see **Views** and **Setup Menu Tab: Select Readouts** for more information). It is important to set this menu option based on the transducer that is connected to the control head, as follows:

- If a **Down Imaging transducer** is connected to the control head, select Auto. Depending on the depth, Auto will automatically choose the 2D conical beams or the Down Imaging beams to display depth in the digital readout window. Auto is the default setting.
- If an **accessory transducer** is connected to the control head, select 2D Element. For example, if you connect an ice transducer to your Down Imaging unit, change the digital depth source to 2D Element in order to display depth in the digital readout window. The 2D Element setting should not be used with a Down Imaging transducer.

***NOTE:** Visit our Web site at humminbird.com to determine which accessory transducers are compatible with your Humminbird Fishfinder, or contact our Customer Service.*

***NOTE:** When Digital Depth Source is set to 2D Element, the DI setting will be removed from the DI Pings menu. When DI Pings is set to DI, the 2D Element setting will be removed from the Digital Depth Source menu. See **DI Pings** for more information.*

DI Pings

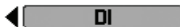

DI Pings

(Advanced, Down Imaging View only [HELIX DI only])

Settings: 2D + DI, DI; Default = 2D + DI

DI Pings allows you to select which beams will be used to display returns in the Down Imaging view.

Select **2D + DI** to display returns from both the 2D sonar beams and the Down Imaging beams.

Select **DI** to display returns from the Down Imaging beams only. Selecting DI provides faster screen updates.

NOTE: When DI Pings is set to DI, the 2D Element setting will be removed from the Digital Depth Source menu. When the Digital Depth Source is set to 2D Element, the DI setting will be removed from the DI Pings menu. See **Digital Depth Source** for more information.

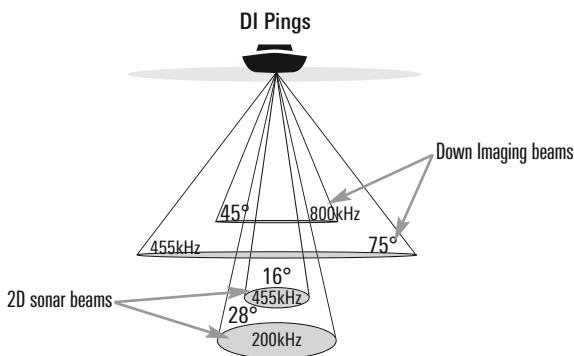

NOTE: See **How Sonar Works: Down Imaging Sonar** for more information.

Color Bar



Color Bar

Settings: Off, On; Default = On

Color Bar allows you to display or suppress the display of the color bar shown in the full screen Sonar View.

Ice Fishing Mode

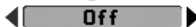

Ice Fishing Mode

Settings: Off, On; Default = Off

Ice Fishing Mode controls how information is displayed in the Circular Flasher View. When Ice Fishing Mode is off, the Circular Flasher View displays Real Time Sonar (RTS) data in a traditional flasher format.

When Ice Fishing Mode is on, the Circular Flasher View displays the data in flasher format with additional features including Zoom and Depth Cursor. Also, the fishfinder's sensitivity settings are adjusted automatically to accommodate ice fishing conditions. These settings will apply to the other Sonar Views until you turn off the Ice Fishing Mode. See **Views: Circular Flasher View** for more information.



DI Colors

(Down Imaging Views [HELIX DI only])

**Settings: Blue, Amber 1, Amber 2, Brown, Green, Inverse, Gray, Green/Red;
Default = Amber 1**

DI Colors allows you to select which color palette you would like to use for the Down Imaging display.

Setup Menu Tab

Units - Depth	Feet
Units - Temp	°F
Units - Distance	Feet/Statute Miles
Units - Speed	kph
User Mode	Advanced
Language	English
Triplog Reset	
Restore Defaults	
Format Nav Directories	
Select Views	
Select Readouts	
Depth Offset	0.0ft
Temp. Offset	0.0°
Speed Calibration	5%
Digits Format	Small tenths
NMEA 0183 Output	
Sonar	On
Demonstration	Visible
Sound Control	All Sounds

From any view, press the MENU key twice to access the tabbed Main Menu, then press the RIGHT Cursor key until the Setup tab is selected.

NOTE: Menu options will vary depending on which accessories are attached to the unit.

*NOTE: Menu options can be expanded or simplified by setting the User Mode to Advanced or Normal. See **Main Menu: User Mode** for details.*

Setup Menu (Advanced)

Units - Depth

 A rectangular menu box with a left-pointing arrow on the left and a right-pointing arrow on the right. The word "Feet" is centered in the box.
Units - Depth**Settings: Various, see below.**

Units - Depth selects the units of measure for all depth-related readouts.

The available Units - Depth settings are determined by your Humminbird model as follows:

- **HELIX 5:** Meters, Feet, Fathoms; Default = Feet
- **HELIX 7:** Domestic Models: Feet, Fathoms; International Models: Meters, Feet, Fathoms; Default = Feet/Meters

Units - Temp

 A rectangular menu box with a left-pointing arrow on the left and a right-pointing arrow on the right. The symbol "°F" is centered in the box.
Units - Temp*(International Models only)***Settings: Celsius, Fahrenheit; Default = Fahrenheit**

Units - Temp selects the units of measure for all temperature-related readouts.

Units - Distance

 A rectangular menu box with a left-pointing arrow on the left and a right-pointing arrow on the right. The text "Feet/Statute Miles" is centered in the box.
Units - Distance*(with Speed input only)***Settings: Various, see below.**

Units - Distance selects the units of measure for all distance-related readouts, and will appear in the menu if a Temp/Speed Accessory is connected and the paddlewheel has moved at least once, or if the GPS Receiver is connected.

The available Units - Distance settings are determined by your Humminbird model as follows:

- **HELIX 5:** Meters/Kilometers, Meters/Nautical Miles, Feet/Statute Miles, Feet/Nautical Miles; Default = Feet/Statute Miles
- **HELIX 7:** Domestic Models: Statute Miles, Nautical Miles; International Models: Meters/Kilometers, Meters/Nautical Miles, Feet/Statute Miles, Feet/Nautical Miles; Default = Statute Miles, Meters/Kilometers

Units - Speed

 A rectangular menu box with a left-pointing arrow on the left and a right-pointing arrow on the right. The text "mph" is centered in the box.
Units - Speed*(with Speed input only)***Settings: Various, see below.**

Units - Speed selects the units of measure for speed-related readouts, and will appear in the menu if a Temp/Speed Accessory is connected and the paddlewheel has moved at least once, or if the GPS Receiver is connected.

The available Units - Speed settings are determined by your Humminbird model as follows:

- **HELIX 5:** kph, mph, kts; Default = mph
- **HELIX 7:** Domestic Models: mph, kts; International Models: kph, mph, kts; Default = mph/kph

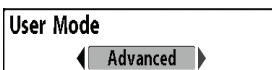

User Mode

Settings: Normal, Advanced; Default = Advanced

User Mode sets the menu system to Normal or Advanced. When set to Normal, the basic set of menu options are shown in the menu system. When set to Advanced (default setting), additional menu options are added to the menu system. See *Main Menu: User Mode* for details.



Language

(International Models only)

Settings: Various, Default = English

Language selects the display language for menus.

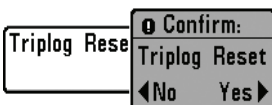

Triplog Reset

(with Speed input only)

Settings: Press the RIGHT Cursor key and follow screen instructions to activate.

Triplog Reset resets the Triplog to zero, and will appear in the menu if a Temp/Speed Accessory is connected and the paddlewheel has moved at least once, or if the GPS Receiver is connected.

The Triplog provides the following information: timer for elapsed time, distance traveled since last reset, and average speed.

NOTE: See Views to find out how to display Triplog information on the screen.

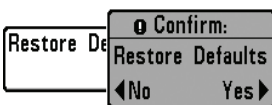

Restore Defaults

Settings: Press the RIGHT Cursor key and follow screen instructions to activate.

Use this menu choice with caution!

Restore Defaults resets ALL menu settings to their factory defaults.

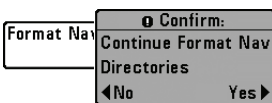

Format Nav Directories

(separate-purchase GPS receiver required)

Settings: Press the RIGHT Cursor key and follow screen instructions.

Use this menu choice with caution!

Format Nav Directories deletes ALL navigation data (waypoints, routes, tracks, and groups) and resets the navigation data directory in the Waypoint Management dialog box. You may need to reset the navigation directory if you've imported corrupted navigation data from an unknown source, which can cause the unit to malfunction. Contact Customer Service before using this menu option.

NOTE: It is important to back up your control head's data files periodically. Data files should also be saved to your PC before restoring the unit's defaults or updating the software. See your Humminbird online account at humminbird.com and the Waypoint Management guide.

Select Views	
Sonar View	Visible
Sonar Zoom View	Visible
Split Sonar View	Visible
Big Digits View	Visible
Circular Flasher View	Visible
Self Test	Hidden
Accessory Test	Hidden

Select Views

Select Views

(Advanced)

Select Views allows you to set the available views to either hidden or visible in the view rotation. The view will be removed from the view rotation if it is set to Hidden and will be displayed in the view rotation if it is set to Visible.

*NOTE: See **Views** for more information.*

Select Readouts	▶
-----------------	---

Select Readouts

(Advanced)

Settings: Various

Select Readouts sets the information to display in each of the fixed-position data windows on the Sonar View screen. To leave the data window blank, select Off. See **Views: Change Digital Readouts** to change the Select Readouts.

Select Readouts
Readout 1
◀ Depth ▶
Readout 2
Triplog
Readout 3
Position
Readout 4
Temperature
Readout 5
Speed

Select Readouts

Data windows can display readouts from connected equipment such as a GPS Receiver or Temp/Speed accessory (optional-purchase required). Each data window can be empty or contain one of the following information categories:

- Course
- Depth
- Off
- Position
- Speed
- Time + Date
- Timer
- Triplog
- Voltage
- Temperature
- Water Speed

Traditional 2D Sonar and Down Imaging Views: All 5 readouts can be customized.

Sonar View

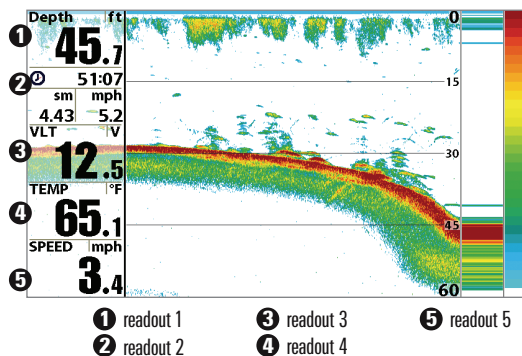

NOTE: The availability of the digital readout information corresponds with the view selected and the accessory attached.



Depth Offset

(Advanced)

Settings: Various, see below.

Depth Offset will adjust the digital depth readout to indicate depth from the waterline or boats keel. Enter a positive vertical measurement from the transducer to the waterline to read the depth from the waterline. Enter a negative vertical measurement from the transducer to keel to read the depth from the keel.

The available Depth Offset settings are determined by your Humminbird model as follows:

- **HELIX 5:** -10.0 to +10.0 feet or -3.0 to +3.0 meters; Default = 0.0, or Off
- **HELIX 7:** -10.0 to +10.0 feet or -3.0 to +3.0 meters (International Models only); Default = 0.0, or Off



Temp. Offset

(Advanced)

Settings: -10.0 to +10.0 degrees, Default = 0.0, or Off

Temp Offset will adjust the temperature readout by the amount entered.



Speed Calibration

(Advanced, with Speed paddlewheel only)

Settings: -20% to +20%, Default = 0%

Speed Calibration will adjust the speed readout by the amount entered. This menu option is available if a Temp/Speed Accessory is connected and the paddlewheel has moved at least once.

Digits Format

Digits Format*(Advanced)***Settings: Small tenths, Large tenths, No tenths; Default = Small tenths**

Digits Format adds a tenth decimal place to the readouts such as Temperature and Depth. Use the settings to change the display of the decimal place or remove it from the digital readouts. Examples of the different settings are displayed below. Also, see *Select Readouts* and *Views*.

Small tenths

Large tenths

No tenths

NMEA Output

NMEA 0183 Output*(Advanced)***Settings: Off, On; Default = Off**

NMEA Output turns the NMEA* output on or off. NMEA Output should be turned On if you connect the NMEA Output wires of an accessory GPS Receiver cable to another NMEA-compatible device, such as an autopilot or heading sensor.

**NMEA 0183 is a National Marine Electronics Association standard for data communication.*

The following NMEA sentences are output:

- DPT - Depth
- HDG - True Heading, Pitch & Roll
- HDM - Magnetic Heading
- MTW - Water Temperature
- GLL - Lat/Lon Position
- GGA - GPS Fix Data
- RMC - Recommended Minimum Specific GNSS Data
- VTG - Course Over Ground and Ground Speed
- ZDA - Time and Date

Sonar

Sonar**Settings: Off, On; Default = On**

Sonar sets whether the Sonar views are shown in the View rotation. Select Off to deactivate Sonar and remove the Sonar Views from the View rotation.

Demonstration

◀ Off ▶

Demonstration

Settings: Off, Visible; Default = Visible

Demonstration controls whether the Demonstration Mode is visible or off. The Demonstration Mode appears on the screen if you don't press any keys during the warning screen at power up. Menu settings cannot be saved in Demonstration (see *Power On* and *Start-Up Options Menu*).

Sound Control

◀ All Sounds ▶

Sound Control

Settings: No Sounds, Alarms Only, All Sounds; Default = All Sounds

Sound Control allows you to set when the control head will beep or sound because of the key presses and/or alarms.

Maintenance

Your Humminbird fishfinder is designed to provide years of trouble free operation with very little maintenance. Use the following procedures to ensure your Humminbird continues to deliver top performance.

Control Head Maintenance

It is important to consider the following precautions when using your Humminbird control head:

- Chemicals, such as those found in bug spray and sunscreen, may cause permanent damage to the control head screen. Such damage is not covered by the warranty.
- NEVER leave the control head in a closed car or trunk. The high temperatures generated in hot weather can damage the electronics.

Use the following information to keep the control head and screen clean.

- **Screen:** To clean the control head screen, use a mild soap (such as a non-abrasive liquid hand soap) and warm water. Wipe the screen dry with a soft cloth. Be careful to avoid scratching the screen. If water spots remain, use a solution of water and vinegar.

WARNING! Do not use a chemical glass cleaner on the screen. Chemicals in the solution may cause cracking in the lens of the unit.

NOTE: Do not wipe the screen while dirt or grease is on the screen.

- **Control Head:** If the control head comes into contact with salt spray, wipe the affected surfaces with a cloth dampened with fresh water.

Transducer Maintenance

Use the following information to maintain the transducer operation.

- If your boat remains in the water for long periods of time, algae and other marine growth can reduce the effectiveness of the transducer. Periodically clean the face of the transducer with a mild, marine-safe and plastic-safe soap or solution.

NOTE: To clean the transducer, you may need to pivot the transducer up in the bracket.

- If your boat remains out of the water for a long period of time, it may take some time to wet the transducer when it is returned to the water. Small air bubbles can climb to the surface of the transducer and interfere with proper operation. These bubbles dissipate with time, or you can wipe the face of the transducer with your fingers after the transducer is in the water.

Troubleshooting

Before contacting Humminbird Customer Service, please read the following section. Taking the time to review these troubleshooting guidelines may allow you to solve a performance problem yourself, and therefore avoid sending your unit back for repair.

Fishfinder Doesn't Power Up

If your Fishfinder doesn't power up, use the Installation Guide that also comes with it for specific confirmation details, making sure that:

- the power cable is properly connected to the Fishfinder control head
- the power cable is wired correctly, with red to positive battery terminal and black to negative terminal or ground
- the fuse is operational
- the battery voltage of the power connector is at least 10 Volts.

Correct any known problems, including removing corrosion from the battery terminals or wiring, or actually replacing the battery if necessary.

Fishfinder Defaults to Simulator with a Transducer Attached

A connected and functioning transducer will cause the newly-started Fishfinder to go into Normal operating mode automatically. If, when you power up the Fishfinder, it goes into Simulator mode automatically, even though a transducer is already connected, this means that the control head is not detecting the transducer. Perform the following troubleshooting tasks:

- Using the Installation Guide that also comes with your Fishfinder, check to make sure that the transducer cable is securely connected to the Fishfinder. Reconnect if necessary, and power up the Fishfinder again to see if this fixes the problem.
- Replace the non-functioning transducer with a known good transducer if available and power up the control head again.
- Check the transducer cable. Replace the transducer if the cable is damaged or corroded.

Display Problems

There are several main conditions or sources of possible interference that may cause problems with the quality of the information displayed on the control head. Look in the following table for some symptoms of display problems and possible solutions:

Problem	Possible Cause
The control head loses power at high speeds.	If the power output of your boat's engine is unregulated, the control head may be protecting itself using its over-voltage protection feature. Make sure the input voltage does not exceed 20 Volts.
When the boat moves at higher speeds, the bottom disappears or suddenly weakens, or the display contains gaps.	<p>The transducer position may need to be adjusted. A mix of air and water flowing around the transducer (cavitation) may be interfering with the interpretation of sonar data. See your Installation Guide for suggestions on adjusting the transducer position.</p> <p>Electrical noise from the boat's engine may be interfering with sonar reception. See <i>Finding the Cause of Noise</i> for more information.</p>
There are no fish detected, even when you know they are in the water under the boat, or sonar readings seem weak or faulty.	<p>Sonar readings may be affected if the transducer is not positioned correctly (i.e. mounted at an angle, not straight down), or there is some kind of mechanical interference, either because it is mounted inside a hull that is too thick for proper sonar transmission, the bond between the transducer and the hull is not airtight, or because the transducer is dirty. Check with your Installation Guide for guidance on re-positioning the transducer, and make sure the transducer is clean.</p> <p>Low battery voltage may be affecting the power of signal transmission.</p> <p>Electrical noise from the boats engine may be interfering with sonar reception. See <i>Finding the Cause of Noise</i> for more information.</p>

Finding the Cause of Noise

Electrical noise usually affects the display with many black dots at high speeds, and high sensitivity readings. One or more of the following sources can cause noise or interference:

Possible Source of Noise	Isolation
Other electronic devices	Turn off any nearby electronic devices to see if the problem goes away, then turn them on one at a time to see if the noise re-appears.
The boat's engine	To determine whether the boat's engine is the source of the noise, increase the RPMs while the boat is in neutral and stationary to see if the noise increases proportionately; if noise appears when you rev the engine, the problem could be the spark plugs, alternator, or tachometer wiring. Replace the spark plugs with resistor plugs, install an alternator filter, or route the control head power and transducer cables away from the engine wiring.
Cavitation from the boat's propeller	Turbulence created by the propeller can cause noise; make sure the transducer is mounted at least 15" (38 cm) from the propeller, and that the water flows smoothly over the face of the transducer at all times.

HELIX 5 Control Head Measurements

Gimbal Mount

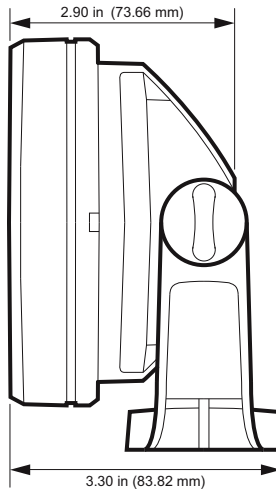
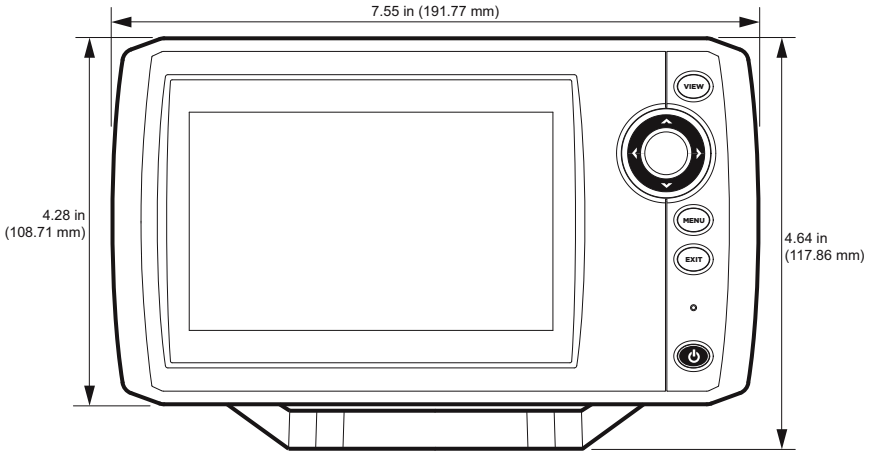

HELIX 5 Control Head Measurements

In-Dash Mount

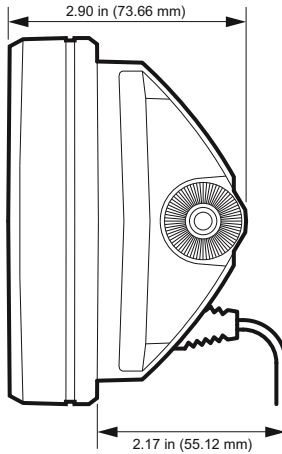
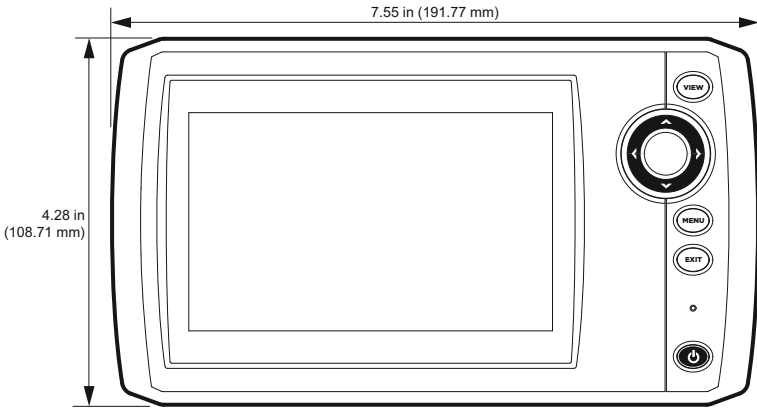

HELIX 7 Control Head Measurements

Gimbal Mount

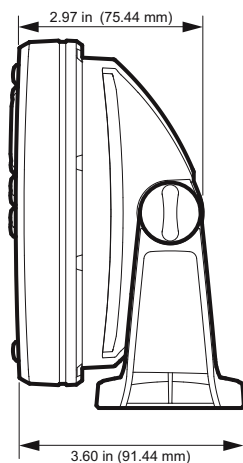
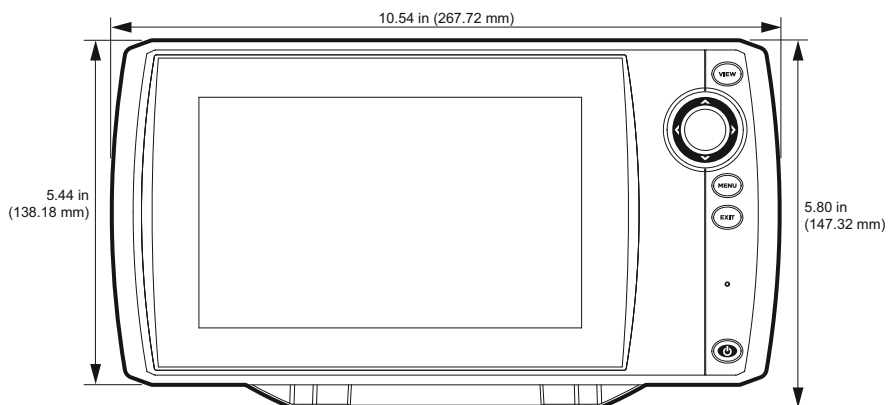

HELIX 7 Control Head Measurements

In-Dash Mount

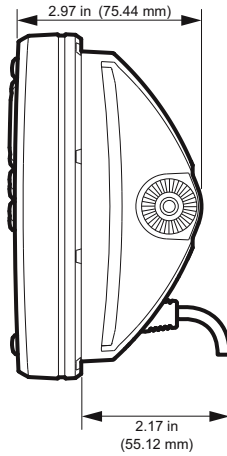
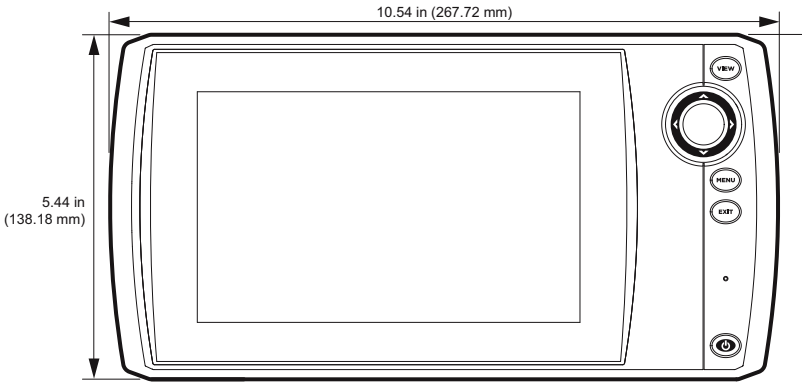

HELIX SONAR Specifications

Depth Capability	1500 ft (500 m)
Power Output	500 Watts (RMS); 4000 Watts (Peak-To-Peak)
Operating Frequency	
DualBeam PLUS:	200 kHz and 83 kHz
Area of Coverage	
DualBeam PLUS:	60° @ -10 dB in 83 kHz and 20° @ -10 dB in 200 kHz
Target Separation	2.5 inches (63.5 mm)
Power Requirement	10-20 VDC
LCD	480 V x 800 H
Current Draw	650 mA
Transducer	XNT 9 20 T (includes built-in temperature probe)
Transducer Cable Length	20 ft (6 m)
IPX Rating	IPX7 Waterproof/Submersible @ 1m for 30 minutes

NOTE: Product specifications and features are subject to change without notice.

NOTE: Humminbird verifies maximum stated depth in saltwater conditions, however actual depth performance may vary due to transducer installation, water type, thermal layers, bottom composition and slope.

HELIX DI Specifications

Depth Capability

Down Imaging: 350 ft (107 m)
Traditional Sonar: 600 ft (183 m)

Power Output 500 Watts (RMS); 4000 Watts (Peak-To-Peak)

Operating Frequency

Down Imaging: 455 kHz, 800 kHz
Traditional Sonar: 200 kHz and 455 kHz

Area of Coverage

Down Imaging: 75° @ -10 dB in 455 kHz, 45° @ -10 dB in 800 kHz
Traditional Sonar: 28° @ -10 dB in 200 kHz
16° @ -10 dB in 455 kHz

Target Separation 2.5 inches (63.5 mm)

Power Requirement 10-20 VDC

LCD 480 V x 800 H

Current Draw 650 mA

Transducer XNT 9 DI T (includes built-in temperature probe)

Transducer Cable Length 20 ft (6 m)

IPX Rating IPX7 Waterproof/Submersible @ 1m for 30 minutes

NOTE: Product specifications and features are subject to change without notice.

NOTE: Humminbird verifies maximum stated depth in saltwater conditions, however actual depth performance may vary due to transducer installation, water type, thermal layers, bottom composition and slope.

ENVIRONMENTAL COMPLIANCE STATEMENT: It is the intention of Johnson Outdoors Marine Electronics, Inc. to be a responsible corporate citizen, operating in compliance with known and applicable environmental regulations, and a good neighbor in the communities where we make or sell our products.

WEEE DIRECTIVE: EU Directive 2002/96/EC "Waste of Electrical and Electronic Equipment Directive (WEEE)" impacts most distributors, sellers, and manufacturers of consumer electronics in the European Union. The WEEE Directive requires the producer of consumer electronics to take responsibility for the management of waste from their products to achieve environmentally responsible disposal during the product life cycle.

WEEE compliance may not be required in your location for electrical & electronic equipment (EEE), nor may it be required for EEE designed and intended as fixed or temporary installation in transportation vehicles such as automobiles, aircraft, and boats. In some European Union member states, these vehicles are considered outside of the scope of the Directive, and EEE for those applications can be considered excluded from the WEEE Directive requirement.



This symbol (WEEE wheeie bin) on product indicates the product must not be disposed of with other household refuse. It must be disposed of and collected for recycling and recovery of waste EEE. Johnson Outdoors Marine Electronics, Inc. will mark all EEE products in accordance with the WEEE Directive. It is our goal to comply in the collection, treatment, recovery, and environmentally sound disposal of those products; however, these requirements do vary within European Union member states. For more information about where you should dispose of your waste equipment for recycling and recovery and/or your European Union member state requirements, please contact your dealer or distributor from which your product was purchased.

ROHS STATEMENT: Product designed and intended as a fixed installation or part of a system in a vessel may be considered beyond the scope of Directive 2002/95/EC of the European Parliament and of the Council of 27 January 2003 on the restriction of the use of certain hazardous substances in electrical and electronic equipment.

Contact Humminbird

Contact Humminbird Customer Service in any of the following ways:

Web site:

humminbird.com

E-mail:

service@humminbird.com

Telephone:

1-800-633-1468

Direct Shipping:

Humminbird
Service Department
678 Humminbird Lane
Eufaula, AL 36027 USA

Hours of Operation:

Monday - Friday

8:00 a.m. to 4:30 p.m. (Central Standard Time)

Social Media Resources:



[Facebook.com/HumminbirdElectronics](https://www.facebook.com/HumminbirdElectronics)



[Twitter.com \(@humminbirdfish\)](https://twitter.com/humminbirdfish)



[YouTube.com/humminbirdtv](https://www.youtube.com/humminbirdtv)

