



ULTERRA™ WITH i-PILOT®

BOW-MOUNT TROLLING MOTOR

OWNER'S MANUAL

CE MASTER USER MANUAL (FOR CE/C-TICK CERTIFIED MODELS)

Conforms to 89/336/EEC (EMC) under standards EN 55022A, EN 50082-2 since 1996 LN V9677264

THANK YOU

Thank you for purchasing the Minn Kota Ultrerra electric steer trolling motor. This motor provides the ultimate hands-free operation by giving the user automatic stow and deploy and power trim as well as all the other Minn Kota electric steer motor features that users have grown to love. The simplicity of use maximizes your time on the water and ensures you spend your time fishing. By following the instructions provided in this manual, you will learn how to properly install and operate your new Ultrerra for years of trouble-free use. We encourage you to read this manual thoroughly in order to maximize your product experience.

REMEMBER TO KEEP YOUR RECEIPT AND IMMEDIATELY REGISTER YOUR TROLLING MOTOR.

A registration card is enclosed or you can complete registration on our website at minnkotamotors.com.

NOTE: Do not return your Minn Kota motor to your retailer. Your retailer is not authorized to repair or replace this unit. You may obtain service by: calling Minn Kota at (800) 227-6433; returning your motor to the Minn Kota Factory Service Center; sending or taking your motor to any Minn Kota authorized service center. A list of authorized service centers is available on our website, at minnkotamotors.com. Please include proof of purchase, serial number and purchase date for warranty service with any of the above options.

Please thoroughly read this user manual. Follow all instructions and heed all safety and cautionary notices below. Use of this motor is only permitted for persons that have read and understood these user instructions. Minors may use this motor only under adult supervision.

ATTENTION: Never run the motor out of the water, as this may result in injuries from the rotating propeller. The motor should be disconnected from the power source when it is not in use or is off the water. When connecting the power-supply cables of the motor to the battery, ensure that they are not kinked or subject to chafe and route them in such a way that persons cannot trip over them. Before using the motor make sure that the insulation of the power cables is not damaged. Disregarding these safety precautions may result in electric shorts of battery(s) and/or motor. Always disconnect motor from battery(s) before cleaning or checking the propeller. Avoid submerging the complete motor as water may enter the lower unit through control head and shaft. If the motor is used while water is present in the lower unit considerable damage to the motor can occur. This damage will not be covered by warranty.

CAUTION: Take care that neither you nor other persons approach the turning propeller too closely, neither with body parts nor with objects. The motor is powerful and may endanger or injure you or others. While the motor is running watch out for persons swimming and for floating objects. Persons whose ability to run the motor or whose reactions are impaired by alcohol, drugs, medication, or other substances are not permitted to use this motor. This motor is not suitable for use in strong currents. The constant noise pressure level of the motor during use is less than 70dB(A). The overall vibration level does not exceed 2,5m/sec².

You are responsible for the safe and prudent operation of your vessel. We have designed Ultrerra to be an accurate and reliable tool that will enhance boat operation and improve your ability to catch fish. This product does not relieve you from the responsibility for safe operation of your boat. You must avoid hazards to navigation and always maintain a permanent watch so you can respond to situations as they develop. You must always be prepared to regain manual control of your boat. Learn to operate your Ultrerra in an area free from hazards and obstacles.

LOCATING YOUR SERIAL NUMBER

Your Minn Kota 11-character serial number is very important. It helps to determine the specific model and year of manufacture. When contacting Consumer Service or registering your product, you will need to know your product's serial number. We recommend that you write the serial number down in the space provided below so that you have it available for future reference.

The serial number on your Ultrerra is located inside the mount near the motor rests.

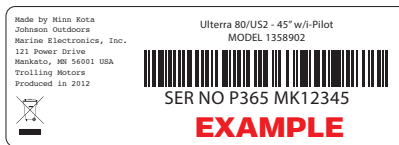

Model: _____

Serial Number: _____

Purchase Date: _____

Store Where Purchased: _____

TABLE OF CONTENTS

Introduction	2
Two-Year Limited Warranty	4-5
Warranty on Minn Kota i-Pilot® and i-Pilot® Link™ Wireless GPS Trolling System	4
Warranty on Minn Kota Freshwater Trolling Motors	5
Features	6-7
Motor Features	6
Control Panel Features	7
i-Pilot Remote Features	7
Foot Pedal Features	7
Mount Installation	8-11
Battery & Wiring Installation	12-13
Boat Rigging & Product Installation	12
Conductor Gauge and Circuit Breaker Sizing Table	12
Selecting the Correct Batteries	13
How to Connect Batteries	13
Motor Wiring Diagram	14
Getting Started	15-19
Knowing Your Remote	15-17
Knowing Your i-Pilot Controller	17-19
System Startup	19
Manual Control	20-21
GPS Motor Control	22-30
Spot-Lock	23-24
Cruise Control	25
AutoPilot/Advanced AutoPilot	26-27
Track Recording/Playback	28-30
Using Your Foot Pedal	31-33
Emergency Stow Procedure	34-35
Adjustments	36
Service & Maintenance	37
Troubleshooting	38-40
Frequently Asked Questions	41-42
Parts Diagram	43-44
Parts List	45-47
Compliance Statements	48-49

TWO-YEAR LIMITED WARRANTY

WARRANTY ON MINN KOTA i-PILOT® AND i-PILOT® LINK™ WIRELESS GPS TROLLING SYSTEM ACCESSORY

Johnson Outdoors Marine Electronics, Inc. ("JOME") extends the following limited warranty to the original retail purchaser only. Warranty coverage is not transferable.

MINN KOTA LIMITED TWO-YEAR WARRANTY ON THE ENTIRE PRODUCT

JOME warrants to the original retail purchaser only that the purchaser's new Minn Kota i-Pilot® or i-Pilot® Link™ Wireless GPS Trolling System Accessory will be materially free from defects in materials and workmanship appearing within two (2) years after the date of purchase. JOME will (at its option) either repair or replace, free of charge, any parts found by JOME to be defective during the term of this warranty. Such repair, or replacement shall be the sole and exclusive liability of JOME and the sole and exclusive remedy of the purchaser for breach of this warranty.

EXCLUSIONS AND LIMITATIONS

This limited warranty does not apply to products that have been used commercially or for rental purposes. This limited warranty does not cover normal wear and tear, blemishes that do not affect the operation of the product, or damage caused by accidents, abuse, alteration, modification, shipping damages, acts of God, negligence of the user or misuse, improper or insufficient care or maintenance. **DAMAGE CAUSED BY THE USE OF OTHER REPLACEMENT PARTS NOT MEETING THE DESIGN SPECIFICATIONS OF THE ORIGINAL PARTS WILL NOT BE COVERED BY THIS LIMITED WARRANTY.** The cost of normal maintenance or replacement parts which are not in breach of the limited warranty are the responsibility of the purchaser. Prior to using products, the purchaser shall determine the suitability of the products for the intended use and assumes all related risk and liability. Any assistance JOME provides to or procures for the purchaser outside the terms, limitations or exclusions of this limited warranty will not constitute a waiver of the terms, limitations or exclusions, nor will such assistance extend or revive the warranty. JOME will not reimburse the purchaser for any expenses incurred by the purchaser in repairing, correcting or replacing any defective products or parts, except those incurred with JOME's prior written permission. **JOME'S AGGREGATE LIABILITY WITH RESPECT TO COVERED PRODUCTS IS LIMITED TO AN AMOUNT EQUAL TO THE PURCHASER'S ORIGINAL PURCHASE PRICE PAID FOR SUCH PRODUCT.**

HOW TO OBTAIN WARRANTY SERVICE

To obtain warranty service in the U.S., the product believed to be defective, and proof of original purchase (including the date of purchase), must be presented to Minn Kota's factory service center in Mankato, MN. Any charges incurred for service calls, transportation or shipping/freight to/from the factory, labor to haul out, remove, re-install or re-rig products removed for warranty service, or any other similar items are the sole and exclusive responsibility of the purchaser. Products purchased outside of the U.S. must be returned prepaid with proof of purchase (including the date of purchase and serial number) to any Authorized Minn Kota Service Center in the country of purchase. Warranty service can be arranged by contacting the factory at 1-800-227-6433 or email service@minnkotamotors.com. **Products repaired or replaced will be warranted for the remainder of the original warranty period [or for 90 days from the date of repair or replacement, whichever is longer]. For any product that is returned for warranty service that JOME finds to be not covered by or not in breach of this limited warranty, there will be a billing for services rendered at the prevailing posted labor rate and for a minimum of at least one hour.**

NOTE: Do not return your Minn Kota product to your retailer. Your retailer is not authorized to repair or replace products.

THERE ARE NO EXPRESS WARRANTIES OTHER THAN THESE LIMITED WARRANTIES. IN NO EVENT SHALL ANY IMPLIED WARRANTIES INCLUDING ANY IMPLIED WARRANTIES OF MERCHANTABILITY OR FITNESS FOR PARTICULAR PURPOSE, EXTEND BEYOND THE DURATION OF THE RELEVANT EXPRESS LIMITED WARRANTY. IN NO EVENT SHALL JOME BE LIABLE FOR PUNITIVE, INDIRECT, INCIDENTAL, CONSEQUENTIAL OR SPECIAL DAMAGES. Without limiting the foregoing, JOME assumes no responsibility for loss of use of product, loss of time, inconvenience or other damage.

Some states do not allow limitations on how long an implied warranty lasts or the exclusion or limitation of incidental or consequential damages, so the above limitations and/or exclusions may not apply to you. This warranty gives you specific legal rights and you may also have other legal rights which vary from state to state.

WARRANTY ON MINN KOTA FRESHWATER TROLLING MOTORS

Johnson Outdoors Marine Electronics, Inc. ("JOME") extends the following limited warranty to the original retail purchaser only. Warranty coverage is not transferable.

MINN KOTA LIMITED TWO-YEAR WARRANTY ON THE ENTIRE PRODUCT

JOME warrants to the original retail purchaser only that the purchaser's new Minn Kota freshwater trolling motor will be materially free from defects in materials and workmanship appearing within two (2) years after the date of purchase. JOME will (at its option) either repair or replace, free of charge, any parts found by JOME to be defective during the term of this warranty. Such repair, or replacement shall be the sole and exclusive liability of JOME and the sole and exclusive remedy of the purchaser for breach of this warranty.

MINN KOTA LIMITED LIFETIME WARRANTY ON COMPOSITE SHAFT

JOME warrants to the original retail purchaser only that the composite shaft of the purchaser's Minn Kota trolling motor will be materially free from defects in materials and workmanship appearing within the original purchaser's lifetime. JOME will provide a new composite shaft, free of charge, to replace any composite shaft found by JOME to be defective during the term of this warranty. Providing a new composite shaft shall be the sole and exclusive liability of JOME and the sole and exclusive remedy of the purchaser for breach of this warranty; **and purchaser shall be responsible for installing, or for the cost of labor to install, any new composite shaft provided by JOME.**

EXCLUSIONS & LIMITATIONS

This limited warranty does not apply to products that have been used in saltwater or brackish water, commercially or for rental purposes. This limited warranty does not cover normal wear and tear, blemishes that do not affect the operation of the product, or damage caused by accidents, abuse, alteration, modification, shipping damages, acts of God, negligence of the user or misuse, improper or insufficient care or maintenance. **DAMAGE CAUSED BY THE USE OF OTHER REPLACEMENT PARTS NOT MEETING THE DESIGN SPECIFICATIONS OF THE ORIGINAL PARTS WILL NOT BE COVERED BY THIS LIMITED WARRANTY.** The cost of normal maintenance or replacement parts which are not in breach of the limited warranty are the responsibility of the purchaser. Prior to using products, the purchaser shall determine the suitability of the products for the intended use and assumes all related risk and liability. Any assistance JOME provides to or procures for the purchaser outside the terms, limitations or exclusions of this limited warranty will not constitute a waiver of the terms, limitations or exclusions, nor will such assistance extend or revive the warranty. JOME will not reimburse the purchaser for any expenses incurred by the purchaser in repairing, correcting or replacing any defective products or parts, except those incurred with JOME's prior written permission. **JOME'S AGGREGATE LIABILITY WITH RESPECT TO COVERED PRODUCTS IS LIMITED TO AN AMOUNT EQUAL TO THE PURCHASER'S ORIGINAL PURCHASE PRICE PAID FOR SUCH PRODUCT.**

MINN KOTA SERVICE INFORMATION

To obtain warranty service in the U.S., the product believed to be defective, and proof of original purchase (including the date of purchase), must be presented to a Minn Kota Authorized Service Center or to Minn Kota's factory service center in Mankato, MN. Any charges incurred for service calls, transportation or shipping/freight to/from the Minn Kota Authorized Service Center or factory, labor to haul out, remove, re-install or re-rig products removed for warranty service, or any other similar items are the sole and exclusive responsibility of the purchaser. Products purchased outside of the U.S. must be returned prepaid with proof of purchase (including the date of purchase and serial number) to any Authorized Minn Kota Service Center in the country of purchase. Warranty service can be arranged by contacting a Minn Kota Authorized Service Center or by contacting the factory at 1-800-227-6433 or email service@minnkotamotors.com. **Products repaired or replaced will be warranted for the remainder of the original warranty period [or for 90 days from the date of repair or replacement, whichever is longer]. For any product that is returned for warranty service that JOME finds to be not covered by or not in breach of this limited warranty, there will be a billing for services rendered at the prevailing posted labor rate and for a minimum of at least one hour.**

NOTE: Do not return your Minn Kota product to your retailer. Your retailer is not authorized to repair or replace products.

THERE ARE NO EXPRESS WARRANTIES OTHER THAN THESE LIMITED WARRANTIES. IN NO EVENT SHALL ANY IMPLIED WARRANTIES INCLUDING ANY IMPLIED WARRANTIES OF MERCHANTABILITY OR FITNESS FOR PARTICULAR PURPOSE, EXTEND BEYOND THE DURATION OF THE RELEVANT EXPRESS LIMITED WARRANTY. IN NO EVENT SHALL JOME BE LIABLE FOR PUNITIVE, INDIRECT, INCIDENTAL, CONSEQUENTIAL OR SPECIAL DAMAGES. Without limiting the foregoing, JOME assumes no responsibility for loss of use of product, loss of time, inconvenience or other damage.

Some states do not allow limitations on how long an implied warranty lasts or the exclusion or limitation of incidental or consequential damages, so the above limitations and/or exclusions may not apply to you. This warranty gives you specific legal rights and you may also have other legal rights which vary from state to state.

FEATURES

MOTOR FEATURES



Specifications subject to change without notice.

*This diagram is for reference only and may differ from your actual motor.

CONTROL PANEL

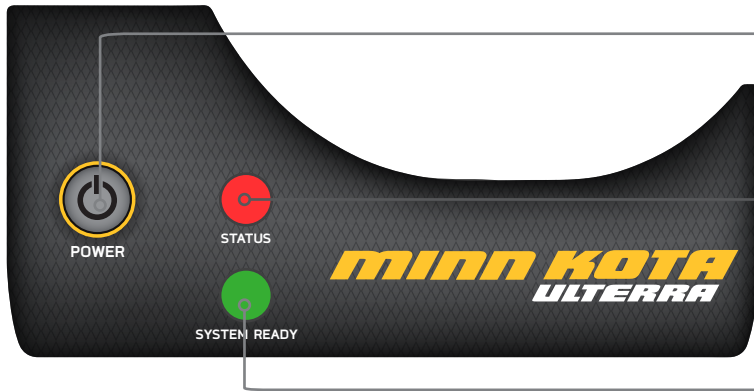

Power Button: Press the power button to turn the motor on or off. Once power button is pressed, power will remain on for 1.5 hours in the absence of any button presses, when motor is stowed. Press and hold for two seconds to turn motor off.

Status (red LED): The motor is equipped with a status indicator. The indicator will flash when the motor is stowing or deploying and will be lit continuously when fully stowed and off when deployed while the power is on.

System Ready (green LED): The motor is equipped with a system ready indicator. The indicator light will be illuminated when the motor is connected to power and switched on.

i-PILOT REMOTE

For complete details on this remote, see page 16 of this manual.



FOOT PEDAL FEATURES



INSTALLATION

PARTS INCLUDED

Your new Ultrerra comes out of the box with everything you'll need for direct to boat mounting. This motor can be direct mounted to the boat or coupled with a Minn Kota quick release bracket for ease of mounting and removal. For compatible quick release mounting brackets and to locate your nearest dealer, visit minnkotamotors.com. Please review the parts list and tools needed for installation prior to getting started.

PARTS LIST

- A. (1) Ultrerra Trolling Motor
- B. (1) Washer, Prop
- C. (1) $\frac{3}{8}$ "-24 Locknut, Prop
- D. (1) Lower Unit Emergency Strap
- E. (1) Universal Sonar Extension Cable (Pre-Installed)
- F. (1) $\frac{3}{16}$ " x 1.00" Pin, Prop
- G. Weedless Wedge 2 Prop
- H. (1) i-Pilot Remote Lanyard
(includes lanyard rope with (1) loop clip and (1) carabiner clip)
- I. (1) i-Pilot Remote
- J. (1) Foot Pedal
- K. Mounting Hardware Bag
- L. Manual CD (not pictured)
- M. Installation Guide (not pictured)



Parts Included:	
Description	Qty.
Screw, 1/4-20 x 2" HHCS SS	6
Screw, 1/4-20 x 0.5 HHCS SS	6
Washer-Clipped, 1/4", 1" OD	6
Nut, 1/4-20 Nylock SS	6
Washer, 1/4" Flat 18-8 SS	6
Washer-Mounting, Rubber	6

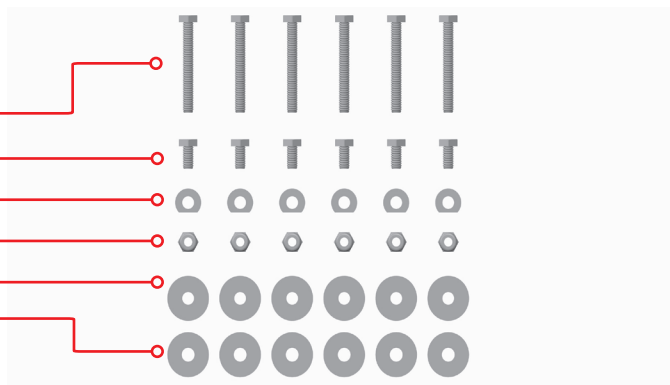

Tools and Resources Required:

- Drill
- 5/16" Drill Bit
- 7/16" Wrench
- 9/16" Wrench (for prop)
- Wire Ties (for cable routing)
- Phillips Screwdriver
- Flat Blade Screwdriver

Installation Instructions:

1. Remove the four sideplate screws. Remove sideplates to access the mounting holes. (Figure 1)



2. Remove the two 5/16" e-clips retaining the extension damper. Remove the extension damper to expose the front left mounting hole. (Figure 2)
3. Place the motor on the bow of the boat. It is recommended that the motor be mounted as close to the centerline of the boat as possible. Make sure the slot on the underside of the mounting base is aligned with the rubrail of the boat. This will ensure that the shaft has a minimum clearance of 1-1/2" when it is deployed. (Figure 3 & 4)



4. Once the motor is positioned, mark at minimum, four of the six holes that are located farthest apart (at least two on each side). Make sure the area under the mounting location is clear to drill holes and install nuts and washers. Drill through the marked holes using a 5/16" drill bit.

INSTALLATION

5. Mount the motor to the boat using the provided hardware. Install the hex head bolts and clipped washers on the right side of the motor as viewed from the boat interior. (Figure 5) Motor can then be slid into place utilizing the slots on the motor base plate. Clipped washer should be oriented with the flat portion against the mounting base. (Figure 6)

Figure 5

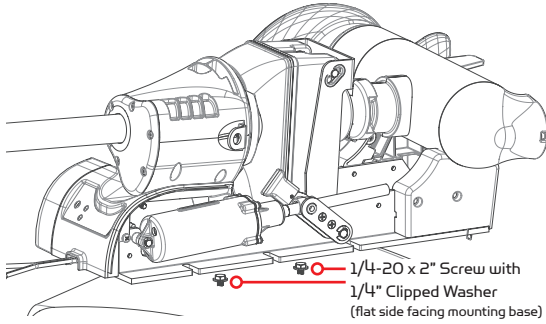
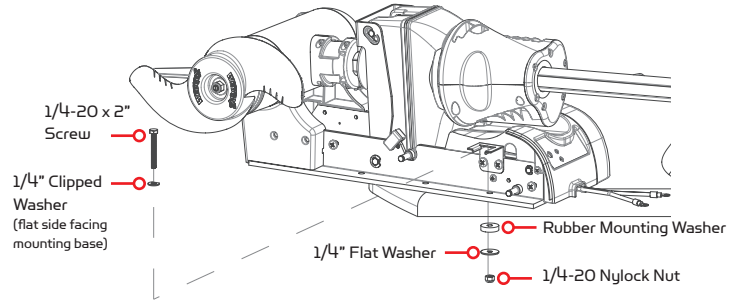

Figure 6



6. Reinstall the extension damper with the shaft facing toward the interior of the boat. Reinstall the e-clips. (Figure 7)



7. Replace the sideplates and sideplate screws by hand using a Phillips screwdriver. (Figure 8) **Note:** Do not use a power tool to install these screws.
8. Connect the motor to power and sonar cable to depth finder using the appropriate adapter cable (sold separately).

MOUNTING OPTIONS

The user has the option of stowing with the prop oriented in or out to accommodate different boat cover configurations. Follow the procedure below to change prop orientation.

1. Turn power on and deploy motor using the stow/deploy button on footpedal or remote (see the Manual Control section or Ulterra Functions for deploying instructions). **CAUTION:** When deploying, ensure the motor doesn't contact boat or trailer.
2. Turn the motor off.
3. Pull out manual trim release handle located on the side of trim housing. (Figure 9)



4. While holding trim release handle, lift up shaft/trim housing and rotate 180 degrees. (Figure 10)
5. Lower shaft and trim housing onto the steering housing. Seat trim housing by holding out manual trim release handle and orienting trim housing onto steering housing. (Figure 11)

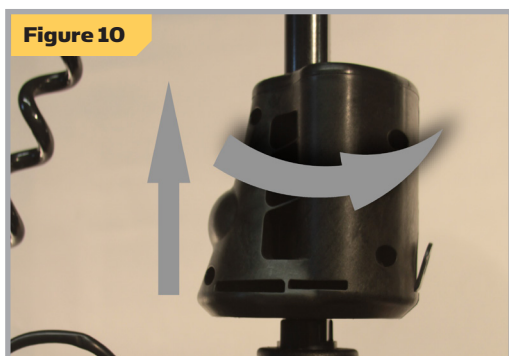

6. Turn on power at the motor power button.
7. Stow the motor using the stow/deploy button on footpedal or remote. The lower unit will stow with the prop in the desired orientation. (Figure 12 & Figure 13)



WARNING: When raising/lowering motor or operating the tilt mechanism, keep fingers clear of all hinge and pivot points and all moving parts.

BATTERY WIRING & INSTALLATION

BOAT RIGGING & PRODUCT INSTALLATION

For safety and compliance reasons, we recommend that you follow American Boat and Yacht Council (ABYC) standards when rigging your boat. Altering boat wiring should be completed by a qualified marine technician. The following specifications are for general guidelines only:

CAUTION: These guidelines apply to general rigging to support your Minn Kota motor. Powering multiple motors or additional electrical devices from the same power circuit may impact the recommended conductor gauge and circuit breaker size. If you are using wire longer than that provided with your unit, follow the conductor gauge and circuit breaker sizing table below. If your wire extension length is more than 25 feet, we recommend that you contact a qualified marine technician.

An over-current protection device (circuit breaker or fuse) must be used. Coast Guard requirements dictate that each ungrounded current-carrying conductor must be protected by a manually reset, trip-free circuit breaker or fuse. The type (voltage and current rating) of the fuse or circuit breaker must be sized accordingly to the trolling motor used. The table below gives recommended guidelines for circuit breaker sizing.

Reference:

United States Code of Federal Regulations: 33 CFR 183 – Boats and Associated Equipment
 ABYC E-11: AC and DC Electrical Systems on Boats

CONDUCTOR GAUGE AND CIRCUIT BREAKER SIZING TABLE

Motor Thrust / Model	Max Amp Draw	Circuit Breaker	Wire Extension Length *				
			5 feet	10 feet	15 feet	20 feet	25 feet
30 lb.	30	50 Amp @ 12 VDC	10 AWG	10 AWG	8 AWG	6 AWG	4 AWG
40 lb., 45 lb.	42		10 AWG	8 AWG	6 AWG	4 AWG	4 AWG
50 lb., 55 lb.	50	60 Amp @ 12 VDC	8 AWG	6 AWG	4 AWG	4 AWG	2 AWG
70 lb.	42	50 Amp @ 24 VDC	10 AWG	10 AWG	8 AWG	8 AWG	6 AWG
80 lb.	56	60 Amp @ 24 VDC	8 AWG	8 AWG	8 AWG	6 AWG	6 AWG
101 lb.	46	50 Amp @ 36 VDC	8 AWG	8 AWG	8 AWG	8 AWG	8 AWG
Engine Mount 101	50	60 Amp @ 36 VDC	8 AWG	6 AWG	4 AWG	4 AWG	2 AWG
112 lb.	52	60 Amp @ 36 VDC	8 AWG	8 AWG	8 AWG	8 AWG	8 AWG
Engine Mount 160	116	(2) x 60 Amp @ 24 VDC	2 AWG	2 AWG	2 AWG	2 AWG	2 AWG
E-Drive	40	50 Amp @ 48 VDC	10 AWG	10 AWG	10 AWG	10 AWG	10 AWG

This conductor and circuit breaker sizing table is only valid for the following assumptions:

1. No more than 3 conductors are bundled together inside of a sheath or conduit outside of engine spaces.
2. Each conductor has 105° C temp rated insulation.
3. No more than 5% voltage drop allowed at full motor power based on published product power requirements.

***Wire Extension Length refers to the distance from the batteries to the trolling motor leads.**

SELECTING THE CORRECT BATTERIES

The motor will operate with any lead acid, deep cycle marine 12 volt battery/batteries. For best results, use a deep cycle, marine battery with at least a 105 ampere hour rating. Maintain battery at full charge. Proper care will ensure having battery power when you need it, and will significantly improve the battery life. Failure to recharge lead-acid batteries (within 12-24 hours) is the leading cause of premature battery failure. Use a multi-stage charger to avoid overcharging. We offer a wide selection of chargers to fit your charging needs. If you are using a crank battery to start a gasoline outboard, we recommend that you use a separate deep cycle marine battery/batteries for your Minn Kota trolling motor.

Advice Regarding Batteries:

- Never connect the (+) and the (-) terminals of the battery together. Take care that no metal object can fall onto the battery and short the terminals. This would immediately lead to a short and extreme fire danger.
- It is highly recommended that a circuit breaker or fuse be used with this trolling motor. Refer to “Conductor Gauge and Circuit Breaker Sizing Table” in the previous section to find the appropriate circuit breaker or fuse for your motor. For motors requiring a 60-amp breaker, the Minn Kota MKR-19 60-amp circuit breaker is recommended.

CONNECTING THE BATTERIES IN SERIES (IF REQUIRED FOR YOUR MOTOR)

24 VOLT SYSTEMS:

1. Make sure that the motor is switched off (speed selector on “0”).
2. Two 12 volt batteries are required.
3. The batteries must be wired in series, only as directed in wiring diagram, to provide 24 volts.
 - a. Connect a connector cable to the positive (+) terminal of battery 1 and to the negative (-) terminal of battery 2.
 - b. Connect positive (+) red motor lead to positive (+) terminal on battery 2.
 - c. Connect negative (-) black motor lead to negative (-) terminal of battery 1.
4. For safety reasons do not switch the motor on until the propeller is in the water. If installing a leadwire plug, observe proper polarity and follow instructions in your boat owner’s manual. See wiring diagram on following pages.

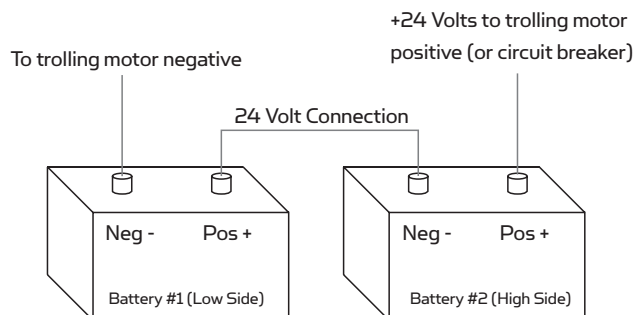

24 Volt Series Connection

CAUTION

- **For safety reasons, disconnect the motor from the battery or batteries when the motor is not in use or while the battery/batteries are being charged.**

36 VOLT SYSTEMS:

1. Make sure that the motor is switched off (speed selector on “0”).
2. Three 12 volt batteries are required.
3. The batteries must be wired in series, only as directed in wiring diagram, to provide 36 volts.
 - a. Connect a connector cable to the positive (+) terminal of battery 1 and to the negative (-) terminal of battery 2 and another connector cable from the positive (+) terminal of battery 2 to the negative (-) terminal of battery 3.
 - b. Connect positive (+) red motor lead to positive (+) terminal on battery 3.
 - c. Connect negative (-) black motor lead to negative (-) terminal of battery 1.
4. For safety reasons do not switch the motor on until the propeller is in the water. If installing a leadwire plug, observe proper polarity and follow instructions in your boat owner’s manual. See wiring diagram on following pages.

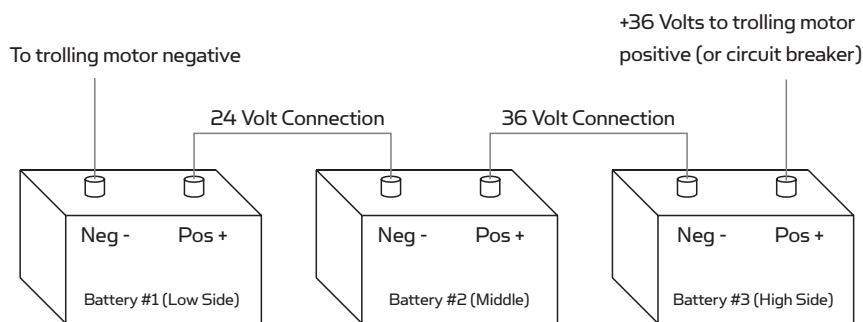

36 Volt Series Connection

CAUTION

- **Improper wiring of 24/36 volt systems could cause battery explosion!**
- **Keep leadwire wing nut connection tight and solid to battery terminals.**
- **Locate battery in a ventilated compartment.**
- **For safety reasons, disconnect the motor from the battery or batteries when the motor is not in use or while the battery/batteries are being charged.**

MOTOR WIRING DIAGRAM

NOTE: This is a universal, multi-voltage diagram. Double-check your motor's voltage for proper connections. Over-Current Protection Devices not shown in this illustration.

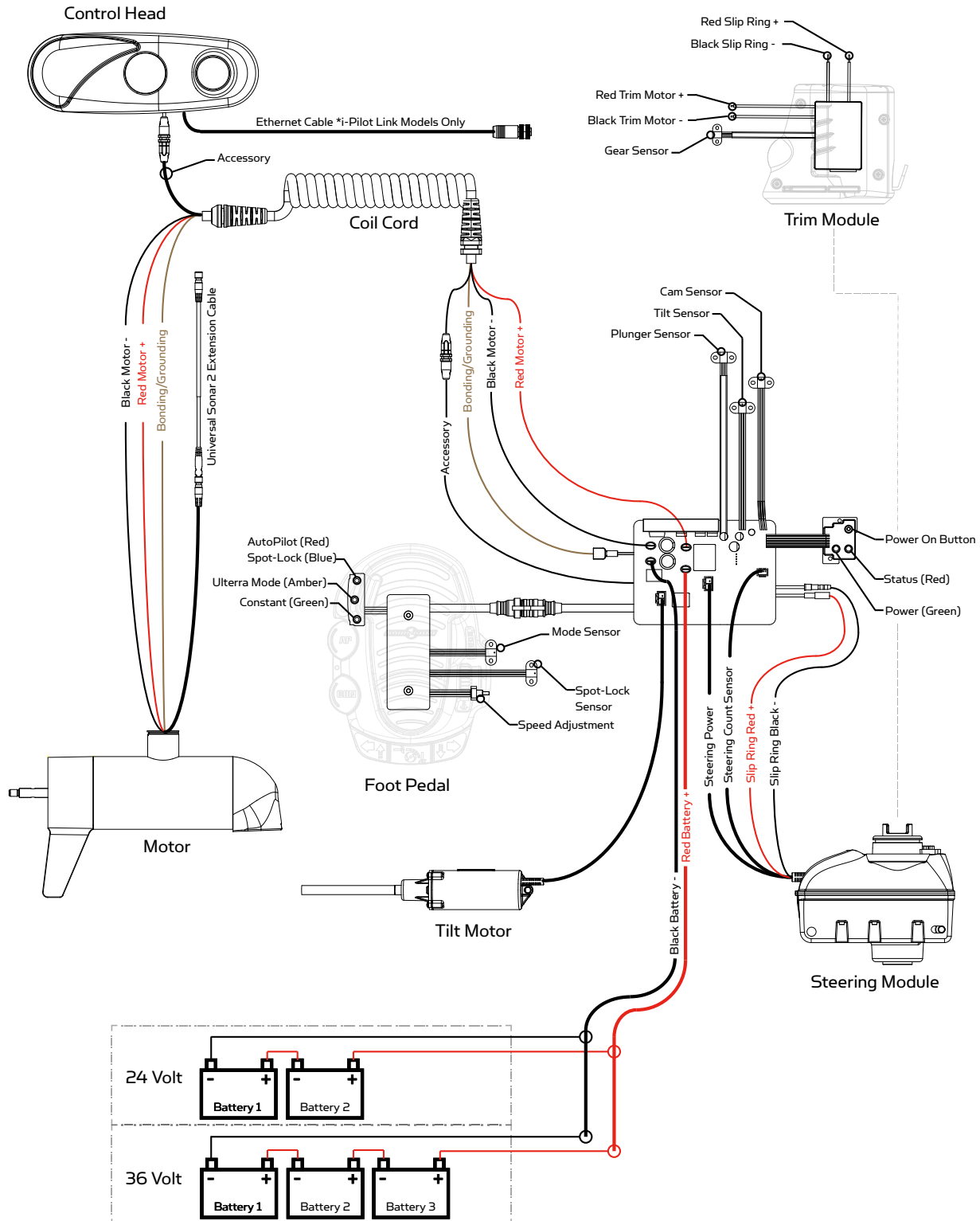

GETTING STARTED

KNOWING YOUR REMOTE

LAYOUT

The i-Pilot remote is divided into four sections: **Manual Control, Tracks, Spot-Lock, and Cruise Control/AutoPilot.** Buttons in the **Manual Control** section of the remote do not require a GPS signal to operate and give you full, immediate control over steering, speed and prop functions similar to a **CoPilot.** All other buttons require a minimum GPS signal strength of one bar in order to operate. Buttons located in the **Tracks** section are used for track recording and playback. **Spot-Lock** buttons are located in the Spot-Lock section. **Cruise Control/AutoPilot** are located in the **Cruise Control/AutoPilot** section.

CONSTRUCTION

The remote is waterproof and floats.

RANGE

The range of the remote will be greatly reduced if it is used near or mounted to any metal object including aluminum or steel. It is also recommended that the front end of the remote not be obstructed during use.

BATTERY LIFE



Remote battery life is subject to frequency of use and is especially impacted by how often the LCD backlight is used.

When the remote battery is low,  will appear on the remote LCD. The **Backlight** button will be disabled when  is displayed to conserve battery power.

POWER

When a button is pressed on the remote it will automatically turn on. To turn the remote off press and hold  for three seconds. The remote will automatically turn itself off thirty minutes after the last button press if a learned i-Pilot controller is powered up and within transmitting range. The remote will turn off after three seconds if the i-Pilot controller is powered down or out of transmitting range.

KEYPAD LOCK

The user can lock the keypad during use to help avoid accidental key activations. To lock or unlock the keypad, press and hold  for 3 seconds. When the keypad is locked,  will appear on the remote LCD. Note that the keypad is always unlocked when the remote is first turned on.

MOTOR BATTERY STATUS

The motor battery status graphic on the remote () will display trolling motor battery voltage. When the prop is on, the battery voltage will not display. The battery voltage meter will reappear once prop is off. This is to ensure that accurate battery charge information is communicated.



MANUAL CONTROL



Steer Left



Steer Right



Prop On/Off



Speed Down



Speed Up



Trim Up



Trim Down



High Speed Bypass
Toggles the motor speed between its current setting and speed 10.



Backlight
Turns the remote LCD backlighting on for six seconds.



Keypad Lock/Unlock
To lock or unlock the keypad, press and hold the backlight button for 3 seconds.



Stow/Deploy Motor

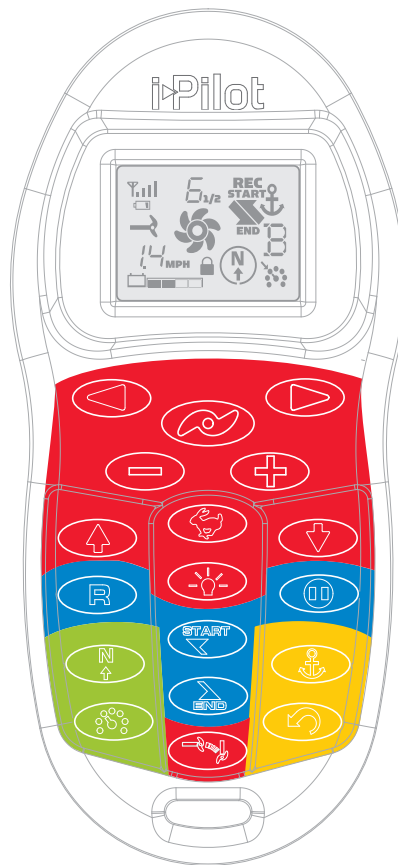

TRACKS



Track to End
Navigates to the nearest location on a previously recorded track and follows it to its end.



Track to Start
Navigates to the nearest location on a previously recorded track and follows it to its start.



Track Record
Starts and ends the recording of a track to a selected memory location.



Record Pause/Escape
Pauses the recording of a track and then resumes the recording when pressed again.



SPOT-LOCK



Spot-Lock
Turns Spot-Lock on and records it to a memory location.



Spot-Lock Recall
Recalls a Spot-Lock from memory and turns spot lock on.



CRUISE CONTROL/AUTOPILOT



Advanced AutoPilot and AutoPilot
Turns Advanced AutoPilot on and off when pressed once. Turns AutoPilot on when held for two seconds.



Cruise Control
Turns cruise control on and off using the current GPS speed as the target speed.

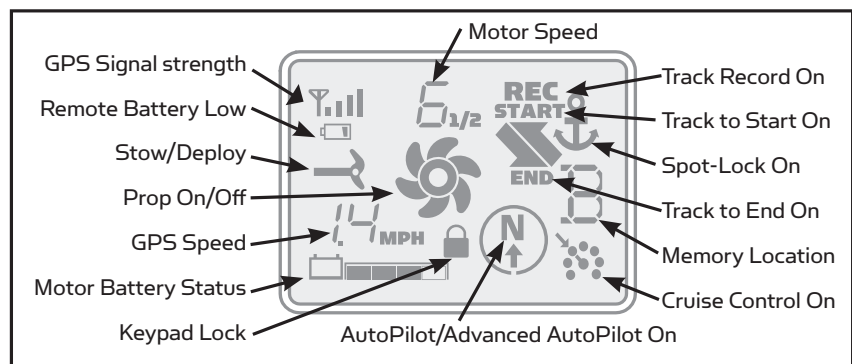

REMOTE BATTERY REPLACEMENT

1. Make sure hands are clean, dry and static free. Discharge any static electricity by touching a metal object that is grounded.
NOTE: Static electricity can damage the circuit board.
2. With the remote upside down, use a large coin to rotate the battery door counterclockwise until either of the Unlock icons align with the arrow (see Figure B).
3. Remove battery cover and old battery and replace with new CR2450 coin cell battery. Note the proper polarity of the battery (see Figure A).
4. Ensure the two rubber o-rings are properly seated in the underside of the battery cover.
5. Replace battery cover by aligning either of the Unlock icons with the arrow, pressing the cover down and rotating clockwise until the Lock icon aligns with the arrow (see Figure C).

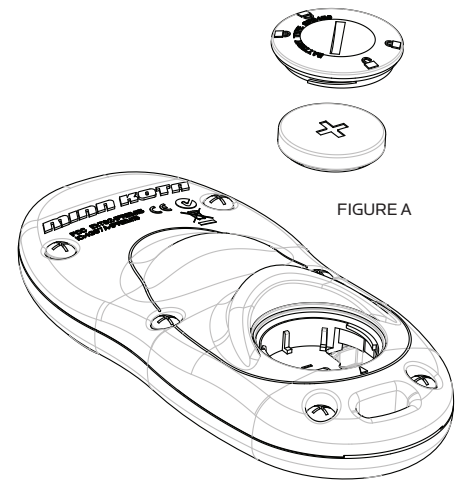

FIGURE A

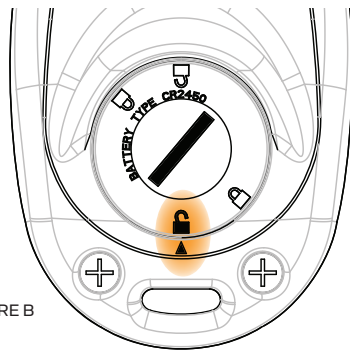

FIGURE B

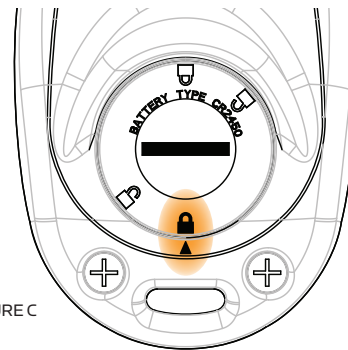

FIGURE C

KNOWING YOUR i-PILOT CONTROLLER

CONSTRUCTION

The i-Pilot controller contains a very sensitive digital compass and is where all GPS satellite and i-Pilot remote signals are received. It is very important that the controller have a clear view of the sky in all directions and has a clear line of sight to the remote for optimum performance. All electronics within the controller enclosure are completely sealed.

REMOTE LEARNING

The i-Pilot remote is prelearned to the controller from the factory. The top of the controller has a single learn button to allow additional remotes to be added to the system. To learn additional remotes:



1. Power up the trolling motor.
2. Press and hold the learn button down. A steady audio tone will be heard while holding this button.
3. While pressing and holding the learn button, push any button on the remote being programmed. Three beeps will be heard when the remote is successfully learned.

A remote can only be learned to one controller at a time. A controller can have an unlimited number of remotes learned to it. During the learn process, the remote must start out in the OFF condition. If necessary, the remote can be turned off by pressing and holding the Pause button for three seconds.



GETTING STARTED

AUDIO MODES

The i-Pilot Controller also contains an internal speaker which can be programmed to work in two different audio modes. The speaker is programmed to operate in audio mode one from the factory. To enable different audio modes hold  and  down at the same time for three seconds. For an explanation of each audio mode and their sounds see the table below.

WHAT CONDITION CAUSES IT	AUDIO MODE	AUDIO PATTERN
Startup	Modes 1 and 2	4 Short beeps
Manual prop on	Mode 2	Single beep
Manual prop off	Mode 2	Double beep
Speed + (when less than max speed)	Mode 2	Single beep
Speed - (when greater than speed 0)	Mode 2	Single beep
High Speed Bypass enable	Mode 2	Single beep
High Speed Bypass disable	Mode 2	Double beep
Button press for any of these (enable or disable): REC, Pause, Track to Start, Track to End, AutoPilot, Cruise Control, Spot-Lock, Spot-Lock Recall	Mode 2	Single beep
Moving more than a quarter mile from the last track point while in Record Pause mode	Mode 2	Error
When GPS Signal Strength goes to no bars while in a GPS-based mode	Mode 2	Error
Attempting to enable a GPS feature when no signal strength bars are shown	Mode 2	Error
Attempting to replay a Track or recall a Spot-Lock location when the boat is beyond the minimum distance	Mode 2	Error
MOM button on the footpedal is pressed and a remote button press attempts to override it	Mode 2	Error
End of track attained during track playback (in conjunction with cancelling mode and turning the prop off)	Mode 2	High-Low, High-Low, High-Low
Switch to Audio Mode 1	Modes 1 and 2	Single beep
Switch to Audio Mode 2	Modes 1 and 2	Double beep
Learn button is pressed	Modes 1 and 2	Steady tone
Learn successfully completed	Modes 1 and 2	3 longer beeps
Initiating a command that is not allowed in the prop lockout region	Mode 2	Error
Deploy	Mode 2	Double beep
Stow	Mode 2	Single beep
Initiating a command that is not allowed in the stow/deploy process	Mode 2	Error
Current Limit	Mode 2	High-Low

POWER

The i-Pilot controller will turn on whenever the trolling motor has power connected and has been turned on. This is when the green system ready light is on.

ACCURACY

The accuracy and responsiveness with which i-Pilot controls your boat is highly dependent upon many variables. Just a few of these variables and their general effects on responsiveness and accuracy are given below so that the behavior of the system can be understood.

VARIABLE	EFFECT
Ratio of motor thrust to boat weight	Excessive thrust on a smaller boat can cause i-Pilot to overcorrect. Not enough thrust on a large boat can cause i-Pilot to respond slowly.
Wind	Excessive wind and/or current can reduce i-Pilot's positioning accuracy.
GPS signal strength	The greater number of GPS signal bars the greater the accuracy.
Trolling motor battery power level	A fully charged battery will give the best performance.

SYSTEM STARTUP

Once you have verified i-Pilot's installation it's time to start using it on the water. Follow these simple steps each time you power up your trolling motor for successful operation:

1. Connect trolling motor to power.
2. Deploy trolling motor into water.
3. Push any button on your remote. The remote LCD will show prop speed and GPS signal strength.
4. You are now able to use all manual functions:



5. After i-Pilot has obtained a minimum GPS signal strength of one bar, all remaining functions will become available.

MANUAL CONTROL

MANUAL CONTROL FUNCTIONALITY

This section describes all Manual Control functions of i-Pilot. A manual function is one in which the operator takes full control of the function such as manually steering the motor in a desired direction or manually adjusting the prop speed to the desired setting, trimming, stowing and deploying, or manually adjusting the prop speed. Any of these functions do not require a GPS signal.



MOTOR ON/OFF

To turn the motor on or off press .

The prop icon on the LCD will be on if the prop is enabled and off if the prop is disabled. With the prop enabled, the icon will be stationary if the motor speed is zero and the icon will rotate if the motor speed is greater than zero.

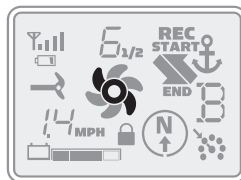

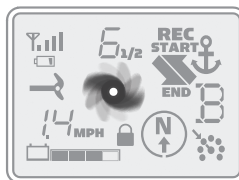

Prop Enabled





Motor Speed Greater Than Zero

MOTOR SPEED CONTROL

Increase Motor Speed

To increase the motor speed push  on the remote. Each push of  will increment the motor speed by 1/2 to a maximum of 10.

DECREASE MOTOR SPEED

To decrease the motor speed push  on the remote. Each push of  will decrement the motor speed by 1/2 to a minimum of 0.

The remote LCD will display the current motor speed setting. This is not to be confused with the GPS speed which is also displayed on the remote LCD.

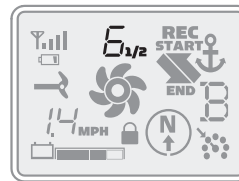

Motor Speed

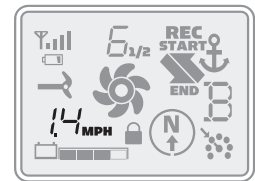

GPS Speed

MOTOR STEERING CONTROL

Steer Left



To steer the motor to the left press .

Steer Right

To steer the motor to the right press .

If a steering button is held down for more than six to eight seconds, the steering will stop to prevent the coil cord from wrapping on the motor.

TRIMMING UP AND DOWN

There will be times when you will need to move your motor up or down depending on how your boat is responding. You can trim up to avoid hitting underwater objects and you can trim down if your prop is coming out of the water. Trim the motor up or down with the i-Pilot remote by pressing  or .



NOTE: The prop will temporarily stop while trimming the motor and resume once trimming is stopped.

NOTE: Trim limits are in place to avoid damage to the unit. An upper trim limit is set 12" from the bottom of the motor mount to the center of the motor. A lower trim limit is set approximately 1.5" from the bottom of the control head to the trim housing.

NOTE: A prop lockout region, defined as 17" from bottom of motor mount to center of motor, is used to eliminate the possibility of the motor contacting the boat hull. All functions with the exception of manual steer and track record are canceled upon trimming into this region.

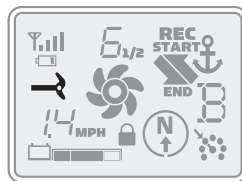

Trim Up/Down

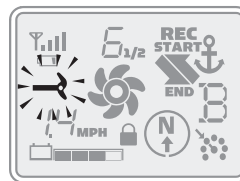

Stow/Deploy

STOWING & DEPLOYING

To deploy the motor with the i-Pilot remote, **double press** .

Pressing the button while deploying will stop the sequence. A second button press will reverse the deploy sequence. Upon deploy the motor will return to its last trim length.

To stow the motor with the i-Pilot remote, press .

Pressing the button while stowing will pause the sequence. If the motor shaft is still vertical a second button press will continue the stow cycle. If the motor shaft is not vertical a second button press will redeploy the motor and return it to its last known trim position.

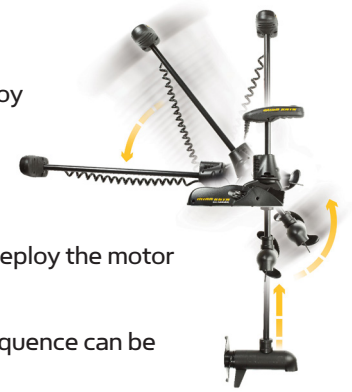

NOTE: The deploy sequence can be stopped at any time pressing the stow/deploy button. The stow sequence can be stopped at any time by pressing either trim button or the stow/deploy button.

HIGH SPEED BYPASS OPERATION

Engage

Pressing  will set the motor speed to maximum immediately.

Disengage

Pressing  again will set the motor speed to the value it was at previously.

NOTE: High Speed Bypass does not enable or disable the prop.

LCD BACKLIGHT BUTTON

To turn on LCD backlighting press and release .

The backlight will turn off eight seconds after the last button press to conserve battery power.

FOOT PEDAL OPERATION



- Pressing either MOM or CON buttons on the foot pedal will adjust the motor speed setting to the foot pedal speed setting.
- While either MOM button is pressed on the foot pedal, all speed and prop changes from the i-Pilot are ignored.

GPS MOTOR CONTROL

UNDERSTANDING HOW THE i-PILOT SYSTEM WORKS

NAVIGATION



i-Pilot uses GPS satellite signals as well as digital compass data to know where it is, where it is heading and the direction the motor is pointing. Since i-Pilot depends on GPS satellite signals for navigation, a minimum GPS signal level of one bar is required in order for GPS navigation controls to be enabled. Best results are achieved when a GPS signal level of four bars can be obtained.

In simple terms, i-Pilot remembers and creates points to navigate your boat automatically. i-Pilot also uses a method of GPS navigation called arrival circles. These imaginary circles allow i-Pilot to understand when it has drifted away from a point and when it has arrived at a point. The size of the arrival circles vary depending on GPS signal strength, thus the greater the signal strength the smaller the arrival circles.

TRACKS

Tracks are made of many points that i-Pilot records when recording a track. The distance between these points varies based on GPS signal strength and the speed at which you record the track. When a track is played back, i-Pilot uses the track points and arrival circles to navigate the track.

MEMORY

i-Pilot has the capability of storing up to six individual tracks (each two miles in length) and six individual **Spot-Lock** locations. These locations are stored in memory even when power is removed from the system. **Spot-Lock** and **Track** memory locations are separate from each other and they cannot over write each other. Memory locations are identified on the remote LCD with an icon shown as A, B, C, D, E or F. When the memory icon is flashing, a different location can be selected by pressing  or .

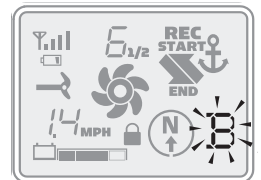

SPOT-LOCK

HOW SPOT-LOCK WORKS





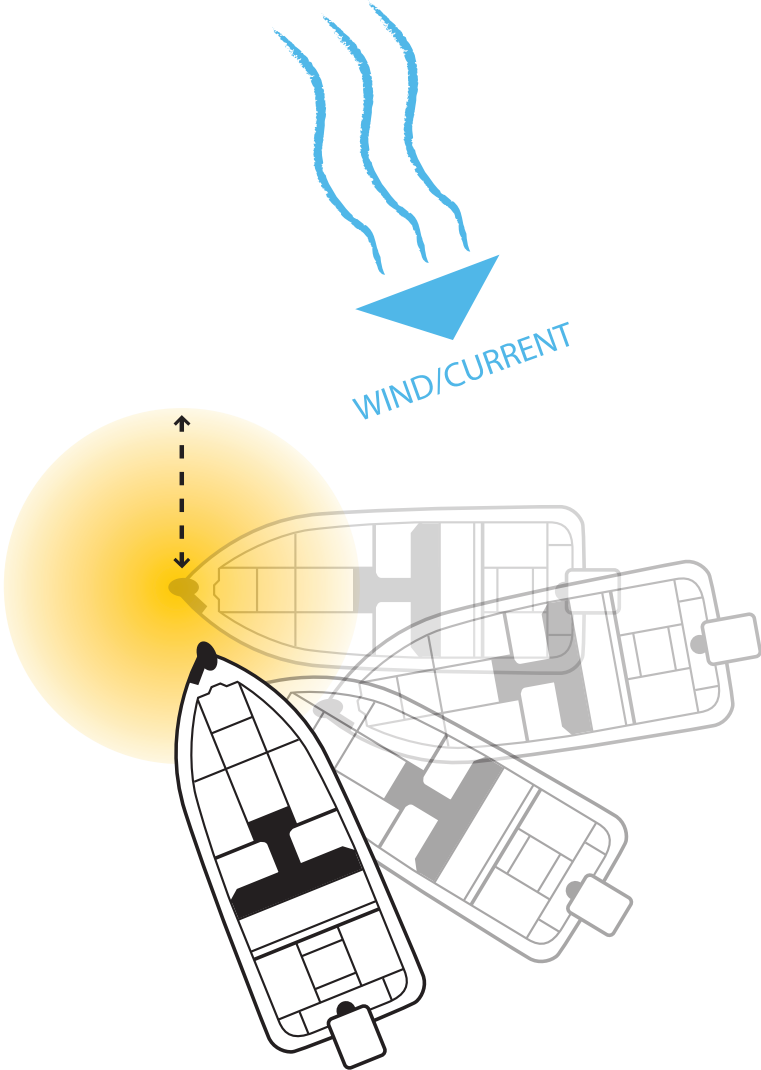

SPOT-LOCK

Spot-Lock uses a single point as a reference for the spot you want to stay on. This point is recorded and stored into one of the six memory locations when the **Spot-Lock** button is pushed. Around the **Spot-Lock** location i-Pilot uses an arrival circle to determine prop speed and direction. If i-Pilot sees it is within the circle, it will adjust the motor speed to zero. If i-Pilot sees it is outside of the circle, it will control motor speed in an attempt to get the boat back into the circle.







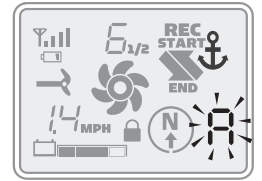

SPOT-LOCK

ENGAGING SPOT-LOCK





1. Press  on the remote.
2. The Memory Location icon will flash on the remote LCD for three seconds, allowing you to choose a memory location by pressing  or . Pressing  again or waiting for three seconds accepts the memory location.



DISENGAGING SPOT-LOCK

1. To disengage **Spot-Lock** press any of these buttons:
     or .
2. Pressing  will disengage **Spot-Lock** and stow the motor, saving **Spot-Lock** to the designated alpha location.

RE-ENGAGE A SAVED SPOT-LOCK LOCATION

1. Manually navigate the boat to within a quarter mile of the saved **Spot-Lock** location.
2. Press  on the remote.
3. The Memory Location icon will flash on the remote LCD for three seconds allowing you to choose a memory location by pressing  or . Pressing  again or waiting for three seconds accepts the memory location.

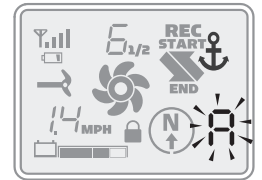

SPOT-LOCK ESCAPE

1. If the **Spot-Lock** button is accidentally hit, press  or any manual navigation button within three seconds to cancel the command.

FOOT PEDAL OPERATION



- Any speed or steering commands from the foot pedal will disengage **Spot-Lock**.
- The momentary button on the foot pedal will not function when **Spot-Lock** or **Spot-Lock** Recall is engaged.

USING SPOT-LOCK WITH OTHER I-PILOT FUNCTIONS

Since **Spot-Lock** takes over full control of the motor, it cannot be used in combination with other i-Pilot functions.

CRUISE CONTROL





HOW CRUISE CONTROL WORKS



CRUISE CONTROL

i-Pilot automatically controls the motor speed to maintain a constant GPS speed.

ENGAGING CRUISE CONTROL

1. Press  on the remote.
2. The current GPS speed will flash, displaying your current speed as the target GPS speed on the remote LCD for three seconds.
3. Press  or  to increase or decrease the target speed or press  again to engage **CruiSe Control** immediately.

DISENGAGE CRUISE CONTROL

1. Pressing  will disengage **CruiSe Control**.
2. Pressing  will disengage **CruiSe Control** and stow the motor..

ADJUSTING TARGET SPEED WITH CRUISE CONTROL ENGAGED

1. With **CruiSe Control** engaged press  or  to adjust the target speed by 0.1 MPH increments.

FOOT PEDAL OPERATION



- Adjusting the motor speed or pressing the CON button from the foot pedal will disengage **CruiSe Control**.

USING CRUISE CONTROL WITH OTHER i-PILOT FUNCTIONS

CruiSe Control can be used in combination with **Advanced AutoPilot**, **AutoPilot**, **Track Recording**, and **Track Playback**.

AUTOPILOT

HOW AUTOPILOT WORKS



Two different versions of **AutoPilot** are available: **AutoPilot** and **Advanced AutoPilot**. There are distinct differences between the two AutoPilots and how they control your boat.

AUTOPILOT

AutoPilot uses an internal compass to provide heading lock. When **AutoPilot** is on, it keeps the motor pointed in the same compass direction. If a manual steering correction is made, **AutoPilot** locks onto the new compass heading to which the boat was steered. This method of heading tracking does not take into account external forces such as a side wind or currents, which can allow side drift.

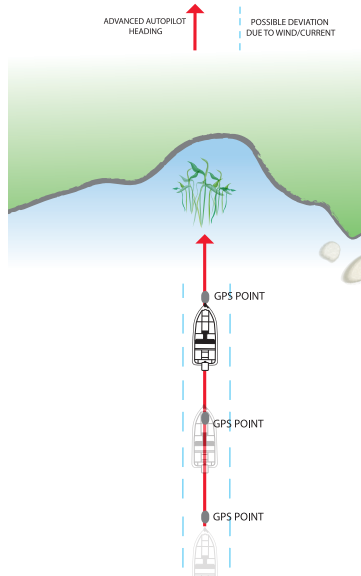
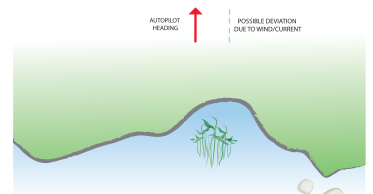

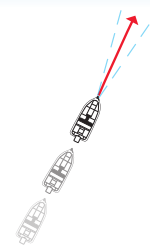

ADVANCED AUTOPILOT

Advanced AutoPilot not only uses compass heading but also GPS signal data to correct for cross winds, current and other external forces to keep the boat on a straight line. When **Advanced AutoPilot** is turned on, it generates a set of GPS points in a straight track line in the heading direction. i-Pilot now navigates to each individual point on this track line. When the user steers to a new heading, a new track line of GPS points are laid down in the new heading direction.



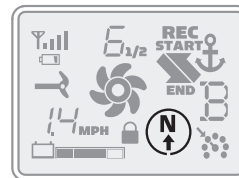

ENGAGING ADVANCED AUTOPILOT AND AUTOPILOT

1. To engage **Advanced AutoPilot**, press  once. To engage **AutoPilot**, press and hold  for two seconds.
2. The **Advanced AutoPilot** or **AutoPilot** icon will be displayed on the remote LCD.
3. To adjust desired heading, manually steer motor to new heading. i-Pilot will lock onto new heading.



Advanced AutoPilot

DISENGAGING ADVANCED AUTOPILOT AND AUTOPILOT

1. Pressing  will disengage **AutoPilot**.
2. Pressing  will also disengage **AutoPilot** and stow the motor.

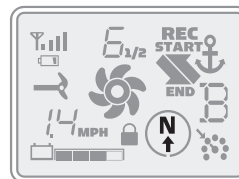

AutoPilot

WHICH AUTOPILOT DO I USE AND WHEN?

With all the external variables, this question can be difficult to answer. Both **AutoPilots** have their benefits based on the type of fishing and bait presentation desired.

Advanced AutoPilot will keep the boat on a true straight path in most conditions. When very extreme conditions exist such as very strong winds or current, the trolling motor may not have enough power to control the boat smoothly. In these extreme cases it may be best to use **AutoPilot** and let the boat move with the wind or current if the motor is not powerful enough to overcome it.

AutoPilot helps you maintain a constant heading but does not compensate for wind or currents.

Both **Advanced AutoPilot** and **AutoPilot** are valuable tools the fisherman can use for accurate and precise bait presentation. We highly recommend getting on the water and trying both **Advanced AutoPilot** and **AutoPilot** in various fishing situations and applications. With experimentation and time you will find which **AutoPilot** works best for you in a given situation.

FOOT PEDAL OPERATION



- **Advanced AutoPilot** can be turned on by pressing the AP button on the foot pedal.
- **AutoPilot cannot** be turned on by using the AP button on the pedal.

USING ADVANCED AUTOPILOT AND AUTOPILOT WITH OTHER I-PILOT FUNCTIONS

Advanced AutoPilot and **AutoPilot** can be used in combination with **Cruise Control** and while recording a track.

TRACK RECORDING / PLAYBACK

HOW TRACK RECORDING AND PLAYBACK WORK



TRACK RECORDING AND PLAYBACK







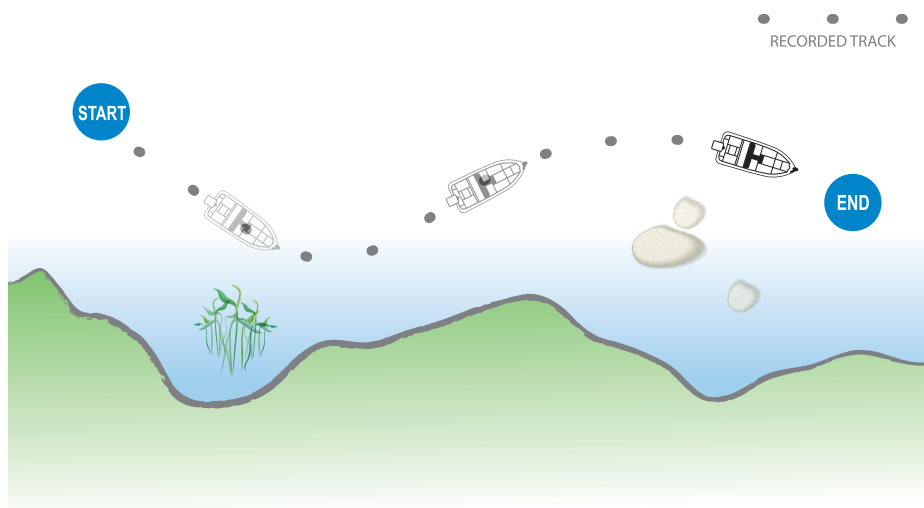

When the **Track Record** button is pressed, i-Pilot starts to record GPS position data in the form of track points. The distance between these points varies based on the speed of the boat and the GPS signal strength. The very first track point recorded is called the start. The last point recorded is called the end. i-Pilot sees a recorded track as a series of these track points. When a **Track to Start** or **Track to End** button is pushed, i-Pilot will navigate to the nearest track point. Once this nearest track point is reached, it will then follow the track points in sequence back to either the start or end based on which button was pressed. Once the end or start track point is reached, i-Pilot automatically exits from the **Track to Start** or **Track to End** function. During track playback, i-Pilot takes control over all steering functions; speed can be manually controlled or the **Cruise Control** function can also be used. The motor speed must be set high enough in order to stay on the track given wind, current and other external forces.

i-Pilot can also pause the recording of a track. When the recording is paused, i-Pilot temporarily stops recording any new track points. When track recording is resumed, i-Pilot records new track points. Due to the nature of pausing a recording, there may be a large separation distance between two track points or two track points lying on top of one another where the pause occurred. This can cause erratic motor steering therefore it is very important to know where the pause button was pressed and to resume the recording just ahead of that location. If while paused, the separation distance exceeds a quarter mile, the recording will automatically stop.

Recording of a track can be done at any motor state (stowed, deployed, or in the stowing/deploying sequence).





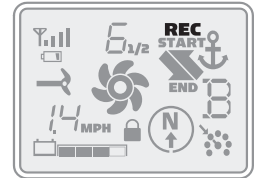

RECORDING A TRACK

1. Press  on the remote.
2. The Memory Location icon will flash on the remote LCD for three seconds, allowing you to choose a memory location by pressing  or . Pressing  again or waiting for three seconds accepts the memory location.
3. The REC icon will be displayed on the remote LCD. Remember this will be the start point on the track.
4. Navigate the boat along the desired path or course. **AutoPilot** and/or **Cruise Control** can be used while recording a track.
5. Press  on the remote again to stop the recording. The recording will end automatically if the two-mile distance limit is reached for the track or if one of the following buttons are pressed: , ,  or .
6. Recording will continue throughout use of the motor, including stowing, until you hit the record button on the remote or you turn the motor off.



PAUSE AND RESUME A RECORDING

1. While recording a track press .
2. The record icon will flash on the remote LCD.
3. i-Pilot has now paused the recording of the track.
4. If the boat moves farther than a quarter mile from where  was pressed, the recorded track will be ended and saved to the memory location previously selected.
5. When ready to resume recording, navigate the boat just ahead of where  was pushed. Failure to do this may cause erratic playback of a track.
6. Push .
7. The record icon will stop flashing on the remote LCD.
8. i-Pilot is now recording again and adding to the track that was paused.

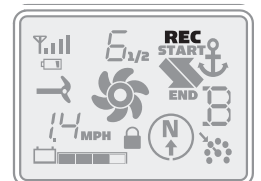
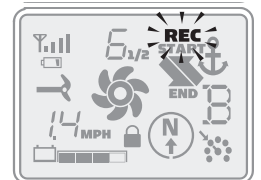

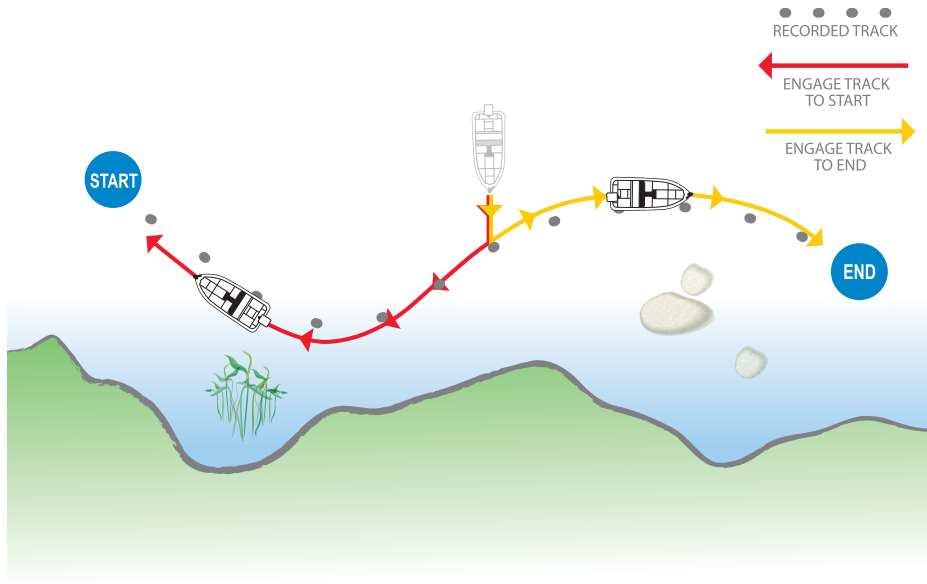

REPLAYING A TRACK (TRACK TO START / TRACK TO END)

1. Manually navigate the boat to within a quarter mile of the saved track. Due to safety reasons, i-Pilot will not re-engage a saved track greater than a quarter mile away.
2. Press or on the remote.
3. The Memory Location icon will flash on the remote LCD for three seconds, allowing you to choose a memory location by pressing or . Pressing the button pressed in step 2 again or waiting for three seconds accepts the memory location.
4. Adjust motor speed to desired setting to engage and navigate track automatically.

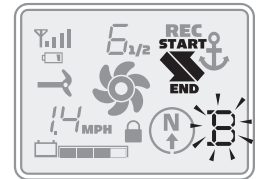

RECORD, TRACK TO END AND TRACK TO START ESCAPE

1. If or is accidentally hit, press within three seconds on the remote to cancel the command.

FOOT PEDAL OPERATION



- Steering left or right or turning **Advanced AutoPilot** on with the foot pedal will disengage **Track to Start** or **Track to End**.



You can switch directly between Track to Start and Track to End. This allows you to concentrate on productive sections of a track.

USING YOUR FOOTPEDAL

ULTERRA FUNCTIONS

Pressing the MODE button allows the use of the Ulterra specific functions. You can steer (heel/toe), trim or stow/deploy the motor while in Ulterra mode.



TRIM UP/DOWN

To trim up/down: Push the mode button until the center yellow LED is lit. Pressing the right button trims the motor down. Pressing the left button trims the motor up. You can trim your motor while in Ulterra mode only.



STOW/DEPLOY

To stow/deploy the motor: Push the mode button until the center yellow LED is lit. Pressing the center Prop button twice will deploy the motor. Pressing the center Prop button once will stow the motor. You can use the stow and deploy commands only while in Ulterra mode.



USING YOUR FOOTPEDAL

PROP ON

All Prop On functions can be used in Standard and Ultrerra Mode.

NOTE: Prop button switches to Stow/Deploy in Ultrerra Mode.

MOMENTARY BUTTON

To operate the motor in momentary mode: Pressing either of the two momentary buttons turns the propeller on at the footpedal speed setting. Let up and the propeller stops. **Prop button will not work with the MODE button engaged.**

CONSTANT BUTTON

To operate the motor in continuous mode: Pressing the Mom/Con button toggles the motor between momentary and constant. When the motor is in constant the propeller will run continuously at the footpedal speed setting without keeping your foot on the pedal. Even while in constant mode, however, the toe button on the heel/toe pedal is momentary. **Prop button will not work with the MODE button engaged.**



STEERING

LEFT/RIGHT TOE BUTTONS

To steer: With the mode button off, left and right steering control can be done with the Left/Right steering buttons. Holding the left or right steering button down steers left or right. Small steering changes of less than one degree can be made by quickly tapping the left and right steering buttons.

HEEL/TOE PEDAL

When the mode button on, place your foot in the center of the heel/toe pedal, rocking forward steers right. Rocking back steers left. The yellow MODE light will be illuminated.

NOTE: The steering system is designed to turn your motor 360 degrees. Be careful to avoid over-wrapping the coil cord around the trolling motor shaft.

Only illuminated in
Ultrerra Mode



SPEED ADJUST

To adjust motor speed: Rotate the speed knob on the right side of the pedal to the desired speed setting. You can adjust the speed in Standard and Ulterra mode.

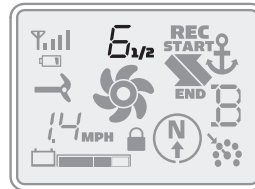

SPOT-LOCK

To initiate Spot-Lock: Pressing the Spot-Lock button initiates Spot-Lock and illuminates the blue indicator light on the footpedal. By default Spot-Lock initiated from the footpedal resides in location "A". Spot-Lock can be engaged in Standard and Ulterra mode.

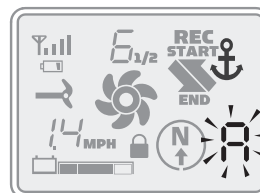
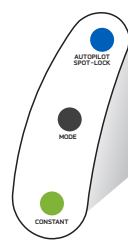

AUTOPILOT

Pressing the AP button toggles the AutoPilot On and Off. The red AutoPilot indicator light will be illuminated on the foot pedal. By default advanced AutoPilot is selected when AutoPilot is initiated from the foot pedal. AutoPilot can be used in both Standard and Ulterra mode.

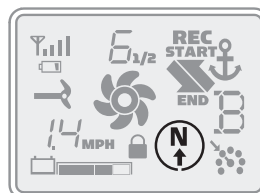
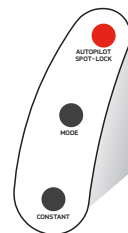

EMERGENCY STOW PROCEDURE

In the event of a power loss the following procedure shall be used to stow the motor for transport to a service center.

1. Remove right hand sideplate using a Phillips screwdriver. (Figure 13)



2. Using a Phillips screwdriver, loosen the screw on the manual tilt knob and then pry up with a flat blade screwdriver until it releases from the metal plates. (Figure 14 and Figure 15)

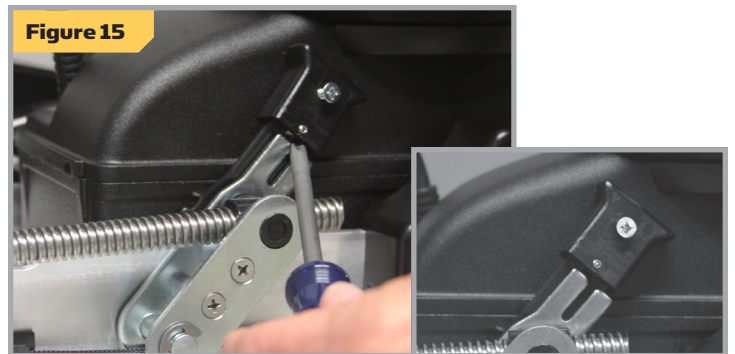
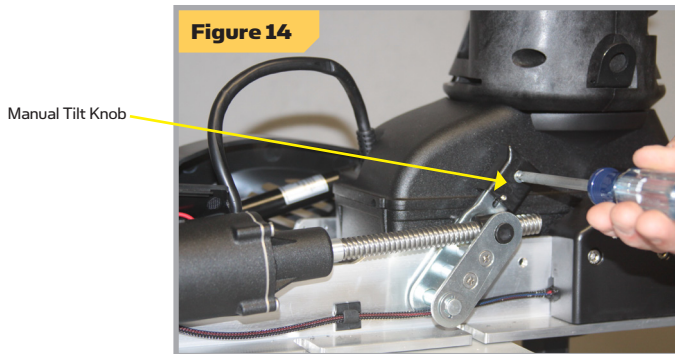

3. Pull manual trim handle out while lifting up on the trim housing until shaft and trim module can be pulled up by hand. (Figure 16)

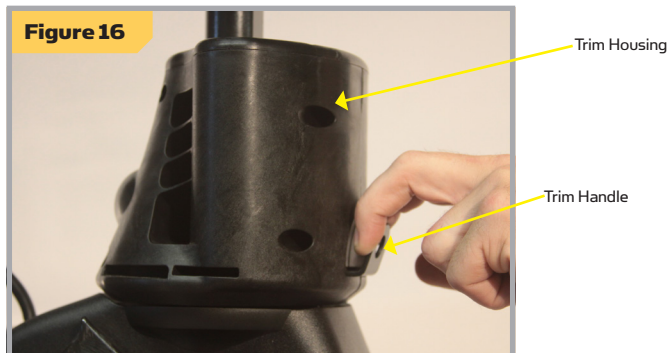

4. While pulling up on the bracket to release the latch pin, rotate (Figure 17) and pull the lower unit onto the ramps. (Figure 18 & Figure 19)

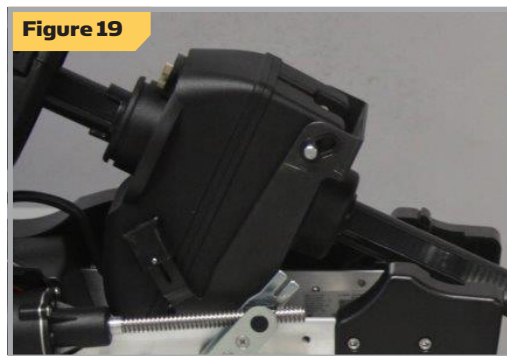
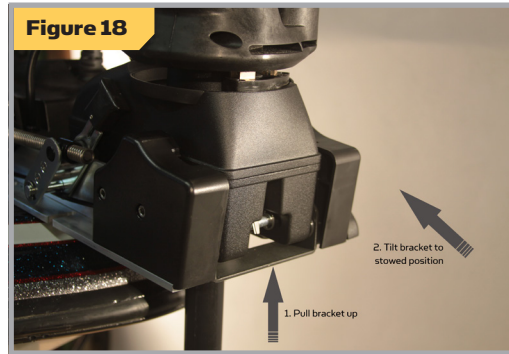

5. Secure lower unit onto the ramps using the provided emergency strap. The d-ring on the emergency strap can be hooked into the base as shown (Figure 20). This feature is located on the left side of the motor as viewed from the boat interior. (Figure 21)

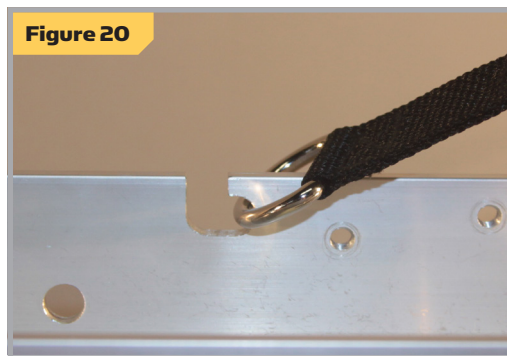

ADJUSTMENTS

ADJUSTING THE LIFT BELT

Periodically slack may appear in the main lift belt, and it may occasionally require small adjustments to maintain belt tension. Using a 1/8" allen wrench turn the socket head cap screw, located on the bottom of the control head, clockwise (see Figure 15) until belt is finger tight and you can force finger under belt.



SERVICE & MAINTENANCE

PROPELLER REPLACEMENT

TOOLS AND RESOURCES REQUIRED:

- Box End Wrench
 - 1/2" for motors with 70 lbs thrust or lower.
 - 9/16" for motors with 80 lbs thrust or higher.
- Screwdriver (optional)

CAUTION:

Disconnect the motor from the battery before beginning any prop work or maintenance.

NOTE: The propeller on your motor may differ from the one pictured.

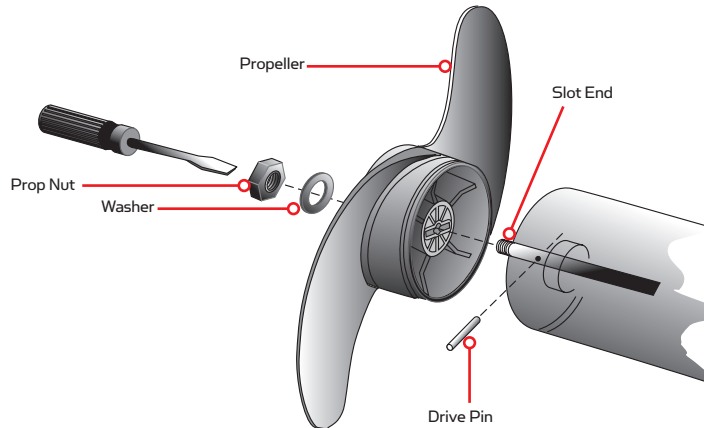

1. Disconnect the motor from all sources of power prior to changing the propeller.
2. Hold the propeller and loosen the prop nut with pliers or a wrench.
3. Remove the prop nut and washer. If the drive pin is sheared or broken, you will need to hold the shaft stationary with a blade screwdriver pressed into the slot on the end of the shaft.
4. Turn the old prop to horizontal (as illustrated) and pull it straight off. If drive pin falls out, push it back in.
5. Align the new propeller with the drive pin.
6. Install the prop washer and prop nut.
7. Tighten the prop nut 1/4 turn past snug [25-35 inch lbs.] Do not over tighten as this can damage the prop.

GENERAL MAINTENANCE

1. After use, the entire motor should be rinsed with freshwater, then wiped down with a cloth dampened with an aqueous based silicone spray. This series of motors is not equipped for saltwater exposure.
2. The propeller must be inspected and cleaned from weeds and fishing line after every use. Fishing line and weeds can get behind the prop, damage the seals and allow water to enter the motor.
3. Verify the prop nut is secure each time the motor is used.
4. To prevent accidental damage during transportation or storage, disconnect the battery whenever the motor is off of the water. For prolonged storage, lightly coat all metal parts with an aqueous based silicone spray.
5. For maximum battery life recharge the battery(s) as soon as possible after use. For maximum motor performance restore battery to full charge prior to use.
6. Keep battery terminals clean with fine sandpaper or emery cloth.
7. The propeller is designed to provide weed free operation with very high efficiency. To maintain this top performance, the leading edge of the blades must be kept smooth. If they are rough or nicked from use, restore to smooth by sanding with fine sandpaper.

TROUBLESHOOTING

ULTERRA

1. Motor fails to run or lacks power:
 - Check battery connections for proper polarity.
 - Are batteries charged?
 - Make sure terminals and wires are clean and corrosion free. Use fine sandpaper or emery cloth to clean terminals.
 - Check circuit protection devices.
 - Check battery water level. Add water if needed.
2. Motor loses power after a short running time:
 - Check battery charge. If low, restore to full charge, or replace.
3. You experience prop vibration during normal operation:
 - Remove and rotate the prop 180°. See removal instructions in the Propeller Replacement Section. Replace prop if worn.
4. Experiencing interference with your fishfinder:
 - You may, in some applications, experience interference in your depth finder display. We recommend that you use a separate deep cycle marine battery for your trolling motor and that you power the depth finder from the starting/cranking battery.
5. Motor contacts an object while trimming causing a current limit (red status LED flashing):
 - Reverse the direction of trimming to clear motor from obstruction.
6. Motor contacts an object while stowing causing current limit (red status LED flashing):
 - Reverse the current cycle by pressing the stow/deploy button to clear from obstruction.
7. Motor fails to trim:
 - Check main lift belt tension per the Adjustments section.
8. Motor fails to stow or deploy:
 - Check for obstructions preventing the motor from deploying or stowing.
 - Ensure that manual tilt knob is engaged. See the Emergency Stow Procedure section for details.
 - Check charge state of trolling motor batteries. If trolling motor battery icon on remote is flashing, battery charge is too low for operation.
9. Prop will not turn on:
 - Ensure batteries are sufficiently charged.
 - For safety reasons there is a prop lock out region (approx. 15" from mounting base to lower unit centerline). Ensure that the lower unit is not in this region.

NOTE: If these problems persist or for all other inquiries, call our customer service number at (800) 227-6433. For motor repair, a listing of Authorized Service Centers in your area can be found at minnkotamotors.com.

i-PILOT GENERAL TROUBLESHOOTING

Problem: **The motor is making erratic steering corrections while in AutoPilot, Spot-Lock or Track to Start/End.**



Solution: Be sure to keep all ferrous metallic objects away from the i-Pilot controller as they will have an impact on the built-in compass. Such objects include: anchors, metal framework, etc.

Problem: **When a button on the remote is pressed the motor doesn't always respond.**

Solutions: Check if the low battery indicator is on. If so, replace the remote's battery. Check for large obstructions between the remote and the motor.

Problem: **I press a button on the remote and nothing happens.**

Solution: Could be a dead battery in the remote. If the battery was just replaced, open the remote case and verify that all the internal components were properly reinstalled.

Solution: If  is displayed, the keypad is locked. Press and hold  for 3 seconds to unlock the keypad.

Problem: **I press a button on the remote and all the icons come on for a few seconds then it shuts off.**

Solutions: Verify that the motor is powered up. Go through the learn process for the remote (see page 17 for the procedure).

Problem: **i-Pilot won't let me turn on certain features like: Advanced AutoPilot, Record, Track to Start/End or Spot-Lock.**

Solution: Verify that the GPS Signal Strength icon on the LCD shows at least one bar. If there are no bars, i-Pilot will not allow these GPS-based features to be enabled.

Problem: **The remote LCD backlighting will not come on.**

Solution: Check if the low battery indicator icon is on. Backlighting is disabled when a low battery level is detected. Replace the battery.

Solution: The **Backlight** will not come on if the remote is not currently communicating with the i-Pilot Controller.

SPOT-LOCK

Problem: **The boat doesn't seem to keep close enough to the recorded Spot-Lock location.**

Solution: Verify the trolling motor batteries are sufficiently charged.

Solution: Check for weeds on the prop.

Solution: In more extreme wind and current conditions, the boat will tend to stabilize a little ways down wind from the intended location. Relock the location the same distance upwind and expect that the boat will drift some in the downwind direction.

CRUISE CONTROL

Problem: **The GPS speed displayed on the remote is different than what my other GPS system shows.**

Solution: If you are using **Cruise Control** with **Advanced AutoPilot** or **Track to Start/End**, i-Pilot calculates the actual speed in the intended direction of travel which may differ from your GPS reported speed.

Problem: **Cruise Control isn't holding the target speed close enough.**

Solution: Verify the trolling motor batteries are sufficiently charged.

TROUBLESHOOTING

AUTOPILOT

Problem: **When in Advanced AutoPilot in strong winds, there is quite a bit of back and forth movement in the boat.**

Solution: While **Advanced AutoPilot** will keep your boat on a true heading, it may be at the expense of the boat having to continuously move to get back on the correct course. In these extreme conditions you may be better off using **AutoPilot** and correcting for the wind manually.

Problem: **I press and release the Advanced AutoPilot button and the system goes into AutoPilot instead of Advanced AutoPilot.**

Solution: If the GPS Signal Strength indicator shows no bars, then pressing and releasing the AutoPilot button will enable **AutoPilot** automatically instead of requiring that the button be held for two to three seconds like when GPS is present.

TRACK RECORD AND PLAYBACK

Problem: **While in Track to Start/End the propeller suddenly stopped.**

Solution: Verify you did not accidentally enable another automatic feature such as **AutoPilot** or **Spot-Lock**.

Solution: When the end (or start) of the track is achieved during playback, i-Pilot will automatically turn off the motor along with canceling **Track to Start/End**.

Problem: **While in Record mode, the recording suddenly stopped.**

Solution: You may have reached the two mile limit for recording a track.

FOR FURTHER TROUBLESHOOTING AND REPAIR

We offer several options to help you troubleshoot and/or repair your product. Please read through the options listed below.

FREQUENTLY ASKED QUESTIONS

We have FAQs available on our website to help answer all of your Minn Kota questions. Visit minnkotamotors.com and click on "Frequently Asked Questions" to find an answer to your question.

CALL US (FOR U.S. AND CANADA)

Our consumer service representatives are available Monday – Friday between 7:00 a.m. – 4:30 p.m. CST at 800-227-6433. If you are calling to order parts, please have the 11-character serial number from your product, specific part numbers, and credit card information available. This will help expedite your call and allow us to provide you with the best consumer service possible. You can reference the parts list located in your manual to identify the specific part numbers.

EMAIL US

You can email our consumer service department with questions regarding your Minn Kota products. To email your question, visit minnkotamotors.com and click on "Support".

AUTHORIZED SERVICE CENTERS

Minn Kota has over 300 authorized service centers in the United States and Canada where you can purchase parts or get your products repaired. Please visit our Authorized Service Center page on our website to locate a service center in your area.

FAQ

ULTERRA

Q: Is there a trolling motor battery meter on Ulterra?

A: Yes. The motor battery meter is displayed on the i-Pilot or i-Pilot Link remote control LCD screen. Battery meter is displayed when prop is off.

Q: Which quick release brackets are compatible with Ulterra

A: The following quick release brackets can be used with Ulterra: MKA-32, MKA-16-02, RTA 17 and RTA 21.

Q: Is there a manual Stow and Deploy procedure?

A: Yes. There is a manual method for stowing Ulterra. See the Emergency Stow Procedure section for instructions.

Q: When Ulterra is deployed, at what depth does the deploy stop?

A: Ulterra will always deploy to the most recent depth that was used.

Q: Are the Ulterra and Terrova foot pedals interchangeable?

A: No. The foot pedals are not interchangeable.

Q: If I engage Spot-Lock on the foot pedal, which Spot-Lock position on the remote is used?

A: i-Pilot: When Spot-Lock is activated from the foot pedal it will always utilize position "A" on the remote.

A: i-Pilot Link: When Spot-Lock is enabled from the foot pedal, the user has the option of saving or discarding the Spot-Lock location. If saved, the next available Spot-Lock number will be utilized.

Q: What is the "Mode" button on the foot pedal?

A: The Ulterra foot pedal is dual function. When it is in "Ulterra" mode, the yellow LED light will be illuminated. In this state the foot pedal toe buttons can be used to auto stow and deploy the motor and control trim. When it is in "steering" mode, the yellow LED will be off. In this state the foot pedal toe buttons can be used to control steering and prop on/off. In either state, the heel/toe pad can be used to control steering.

Q: Is there a way to clean weeds from the lower unit?

A: Yes. During the process of stowing, the stow cycle can be stopped by pressing the stow/deploy button as the motor begins to tilt back. The lower unit is easily accessible at this point to clear weeds. A second button press of the stow/deploy cycle will re-deploy the motor to its previous position.

Q: Can I stow the motor with the prop in or out?

A: Yes, the motor can be configured to stow with either the prop in or out. Follow the procedure outlined in the Installation Mounting Options section.

i-PILOT

Q: Does i-Pilot record the speed I am traveling when recording a track?

A: No. i-Pilot only records its location during track record. It is up to the user to set the desired speed manually or with Cruise Control.

Q: Why doesn't my GPS Signal Strength icon always show all four bars?

A: GPS signal strength is impacted by many influences including:

- i-Pilot controller having a clear view of the sky (especially to the southern sky),
- boat being located alongside a high bank
- your geographic location.

Q: Is i-Pilot compatible with CoPilot?

A: No. None of the components between the two systems are compatible with each other.

Q: Does the remote float?

A: Yes.

Q: How long of a track can I record?

A: Each individual track location (A, B, C, D, E or F) can be up to two miles in length.

Q: Can I use multiple remotes with my i-Pilot?

A: Yes, you can use an unlimited number of remotes simultaneously. Remember to learn each new remote to the i-Pilot controller.

Q: Why does the LCD screen of the remote have dark blotches on it when I wear my sunglasses?

A: Polarized sunglasses can dramatically affect the way an LCD looks to the human eye.

Q: Can I control how fast i-Pilot takes me back to a Spot-Lock location when using Spot-Lock Recall?

A: No, **Spot-Lock** and **Spot-Lock Recall** are fully automatic functions that take full control of motor steering and speed.

Q: Where can I purchase additional remotes?

A: Your local Minn Kota retailer should carry additional remotes.

Q: If I turn off the remote, will i-Pilot continue to operate?

A: Yes. The i-Pilot Controller will continue in its current state of operation until the user makes a change either with the remote or foot pedal (Terrova only).

Q: Where are the six tracks and Spot-Lock locations stored?

A: In the i-Pilot Controller.

Q: Does i-Pilot help to keep the coil cord from wrapping around the motor shaft?

A: Yes and no. When in Spot-Lock, i-Pilot keeps track of how far it has rotated in either direction. If a new correction will cause the coil cord to wrap, it will rotate in the opposite direction in order to prevent the wrapping. In all other modes, it is up to the user to monitor the coil cord and to rotate the motor accordingly to avoid wrapping.

PARTS DIAGRAM

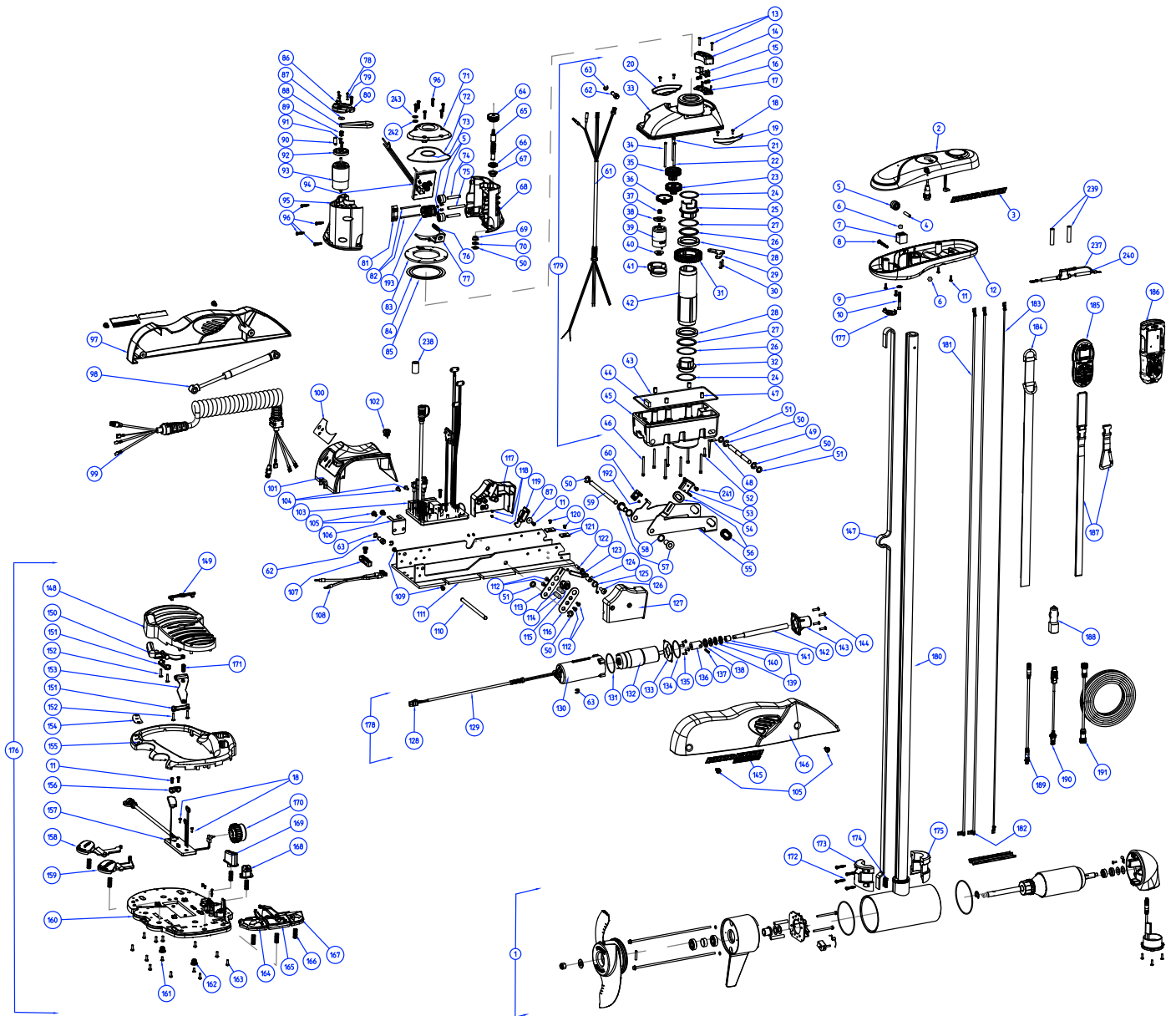

PARTS DIAGRAM

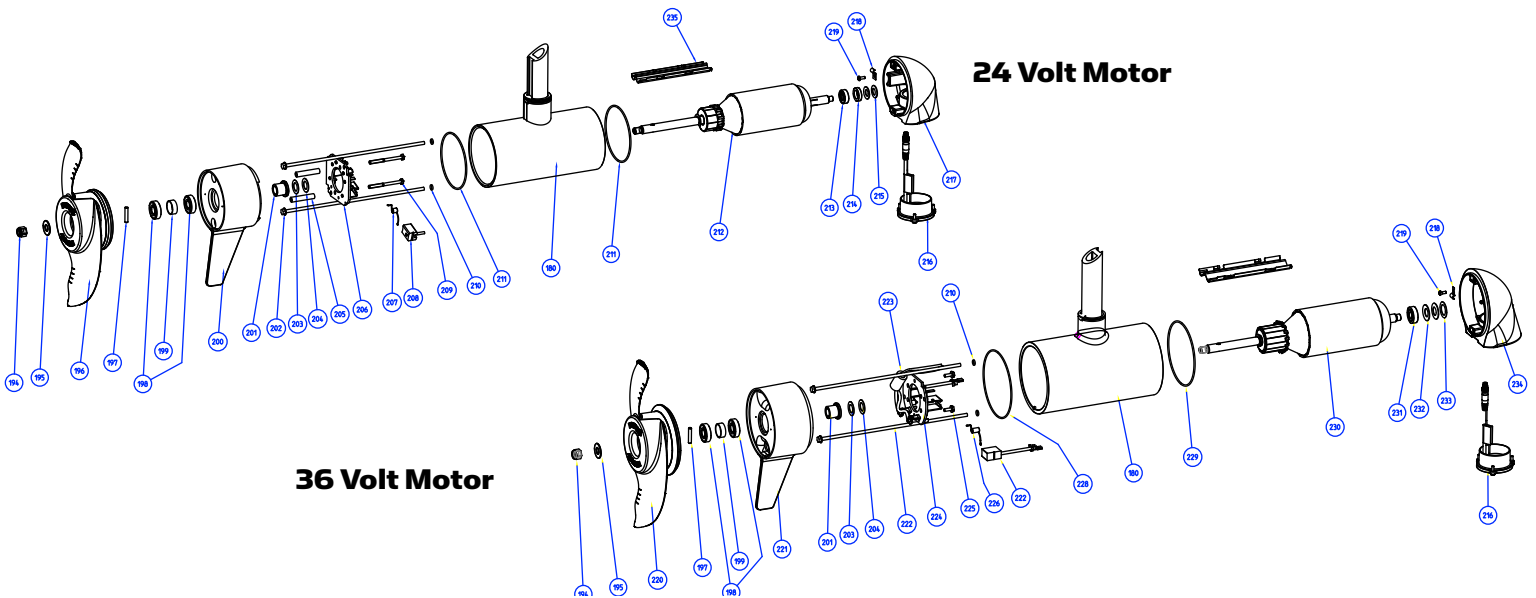

PARTS LIST

ITEM	QTY	PART NUMBER	DESCRIPTION
1	1	2777016	24 V MOTOR 45° FW
	1	2777015	24V MOTOR 60° FW
	1	2777086	36V MOTOR 45° FW
	1	2777085	36V MOTOR 60° FW
2	1	2990206	HEAD ASSY, FW, IPILOT 1.5
	1	2990208	HEAD ASSY, FW, IPILOT LINK
3	2	2205511	DECAL, CONTROL BOX SIDE
4	1	2202635	PIN-DOWEL, 1/4" OD SS
5	3	2202335	PULLEY, BELT, TOP
6	2	2333101	NUT-HEX #10-24
7	1	2202800	BLOCK, BELT
8	1	2332102	SCREW-#10-24 X 1-3/4
9	1	2201721	WASHER, #10 SAE, SS
10	1	2203411	SCREW-#10-24, SHCS, SS
11	6	2372100	SCREW, #8-18 X 5/8 THD
12	1	2202506	CONTROL BOX BOTTOM
13	2	2203406	SCREW, #6-32 X 0.75 PPH, SS
14	1	2202820	BLOCK-BRUSH, SLIPRING
15	2	2208207	BRUSH SHUNT ASSEMBLY
16	4	2202712	SPRING COMPRESSION, BRUSH
17	1	2202815	INSULATOR, BLOCK-BRUSH
18	6	2332103	SCREW-#6-20 X 3/8 THD, SS
19	1	2205905	RIGHT STEERING ADAPTER
20	1	2205900	LEFT STEERING ADAPTER
21	1	2302615	SHAFT-GEAR, INTERMED. CLUSTER
22	1	2302620	SHAFT-GEAR, THIRD CLUSTER
23	1	2302250	GEAR & PINION, DR. HSG, STAGE 3
24	2	2321704	WASHER-THRUST, STEERING
25	1	2201510	COLLAR-DRIVE, OUTPUT TUBE
26	2	2324608	O-RING, 224, PD PRO STEERING HOUSING
27	2	2321720	SHIM, O-RING
28	2	2327308	BEARING-BALL, SEALED, 6809-2R5
29	1	2201920	BRACKET-SENSOR, STEERING HSG
30	2	2303412	SCREW-#6-20 X 5/8 SELF TAP
31	1	2322200	GEAR-OUTPUT
32	1	2321510	COLLAR-DRIVE, BOTTOM
33	1	2206501	BLACK STEERING HSG COVER
34	1	2302610	SHAFT-GEAR, FIRST CLUSTER
35	1	2302255	GEAR & PINION, STAGE 4
36	1	2302245	GEAR & PINION, STAGE 2
37	1	2302240	GEAR & PINION, STAGE 1
38	1	2300265	CAP-MOTOR, PLASTIC
39	1	2327025	MOTOR-STEERING PD/AP 36V
	1	2327020	MOTOR-STEERING PD/AP 24V
40	1	2300260	CAP-SPACER, PLASTIC
41	1	2328610	CRADLE-MOTOR
42	1	2322030	TUBE-OUTPUT, MACHINED
43	1	2324604	O-RING, CASE SEAL
44	1	2308601	BREATHER FILTER, DR. HSG
45	1	2326506	STEERING HSG, BTM, BLK
46	7	2323408	SCREW-#8-32 X 2.0 SHCS SS
47	4	2302605	PIN-ROLL 5/16" X 1/2"
48	2	2322702	SPRING, LATCH PIN SS
49	1	2202625	PIN-LATCH
50	5	2263011	E-RING 3/8 DIA. SHAFT
51	3	2321702	WASHER-FLAT .375 NYLON
52	1	2323410	SCREW-#8-32 X .75 SHCS SS
53	1	2200100	KNOB, TILT RELEASE
54	1	2383463	SCREW-#6-32 X .625" SET SS
55	1	2201911	BRACKET, TILT, ZP
56	2	2207305	BUSHING, LATCH PIN
57	2	2207310	BUSHING, STRG HSG PIVOT
58	2	2201730	WASHER-FLAT, .56 ID NYLON
59	1	2202601	PIN-PIVOT, DRIVE HOUSING, SS
60	1	2778601	HOLDER, TILT, ZP
61	1	2200600	LEADWIRE, STEERING MTR, 8 COND.
62	2	2202902	STANDOFF, OIL DAMPENER
63	4	2263006	E-CLIP, 5/16
64	1	2202332	PULLEY, TRIM JACKSHAFT
65	1	2772310	WORM SHAFT ASSY W/ PULLEY

ITEM	QTY	PART NUMBER	DESCRIPTION
66	1	2200000	BEARING-THRUST, NEEDLE
67	1	2207300	BUSHING, TRIM, TOP
68	1	2206525	HOUSING-TRIM, GEAR SIDE
69	1	2207301	BUSHING, TRIM, BOTTOM
70	1	2201710	WASHER-THRUST, 3/8"
71	1	2206410	COVER, TRIM HOUSING
72	1	2204601	O-RING, TRIM HOUSING
73	1	2204600	O-RING, TRIM HSG COVER
74	2	2202610	PIN, BELT PULLEY
75	1	2202621	PIN, 2"X1/4"
76	1	2202701	SPRING, 5/16" OD, SS
77	1	2200901	HANDLE, TRIM HSG RELS, ZP
78	3	2053422	SCREW-M3-.5 X 10 PPH, ZP
79	3	2051710	LOCKWASHER-SPLIT, 3MM, ZP
80	1	2206400	PLATE, MOTOR
81	1	2202825	BLOCK, TUBE DRIVE
82	2	2202636	PIN-DOWEL, 1/8"
83	1	2208620	CARRIER, SLIPRING CONTACTS
84	1	2203011	CONTACT, SLIPRING SMALL
85	1	2203010	CONTACT, SLIPRING LARGE
86	1	2053420	SCREW-SET-#8-32 X 1/4" SS
87	1	2201722	WASHER-#6, .625 OD
88	1	2200810	BELT-TRIM
89	1	2202336	PULLEY, LIFT MOTOR, MACHINED
90	1	2058411	TENSIONER-BELT
91	2	2053424	SCREW-M4 X 10 PFH, ZP
92	1	2051915	PLATE-ADAPTER, LIFT MOTOR
93	1	2207800	MOTOR, TRIM
94	1	2204003	BOARD ASSY, WIRELESS TRIM
95	1	2206520	HOUSING-TRIM, MOTOR SIDE
96	11	3393481	SCREW, #10X.75 HI-LO, SS, PPH
97	1	2203905	SIDEPLATE, LEFT
98	1	2208800	DAMPER, HYBRID, 80#
	1	2208802	DAMPER, HYBRID, 112#
99	1	2991272	COIL CORD ASSY 54/60" U. SONAR
100	1	2205600	DECAL, B. METER/CON/PWR FW, BLK
101	1	2206510	HOUSING-CONTROL, BLACK
102	1	2202910	STRAIN RLF, HEYCO SR 6N3-4
103	1	2774080	MAIN CONTROL BOARD, 24V, 60°, N AMERICA
		2774081	MAIN CONTROL BOARD, 24V, 45°, N AMERICA
		2774082	MAIN CONTROL BOARD, 36V, 60°, N AMERICA
		2774083	MAIN CONTROL BOARD, 36V, 45°, N AMERICA
		2774084	MAIN CONTROL BOARD, 24V, 60°, EUROPE
		2774085	MAIN CONTROL BOARD, 24V, 45°, EUROPE
		2774086	MAIN CONTROL BOARD, 36V, 60°, EUROPE
		2774087	MAIN CONTROL BOARD, 36V, 45°, EUROPE
104	2	2323406	SCREW-#10-24 X .50 CRPH SS
105	7	2323404	SCREW-1/4-20 X 1/2" T-L ZP
106	1	2200821	CLIP-CORD, ZP
107	1	2321310	STRAIN RELIEF
108	1	2090651	LEADWIRE, 10 GA
109	2	2383447	SCREW-#10-32 X 3/8" PPH SS
110	1	2202606	PIN, ACTUATOR, ZP
111	1	2201901	BASE, MACHINED, FW
112	4	2203410	SCREW #10-32 X .5"
113	1	2204201	ARM-LIFT, INNER, ZP
114	2	2202901	STANDOFF, LIFT ARM
115	1	2203100	NUT, TILT MOTOR
116	1	2204206	ARM-LIFT, OUTER, ZP
117	1	2203916	RAMP-MOTOR, LEFT 80#
	1	2203915	RAMP-MOTOR, LEFT 112#
118	10	2373440	SCREW-#4-24 X 1/4 PHCR SS TY B
119	1	2773700	PLUNGER, RAMP
120	2	2203420	SCREW #10-24 X 5/16 PFH
121	2	2205105	PAD, STOP
122	1	2262632	PIN-SPRING 1/4" X 5/8" SS
123	1	2207900	CAM, PIN SENSOR
124	1	2201702	SPACER, PIN SENSOR
125	1	2042711	SPRING-TORSION, SS
126	1	9280710	HDW SCR 1/4 - 20 X 7/8 TRUSS PHIL

PARTS LIST

ITEM	QTY	PART NUMBER	DESCRIPTION
127	1	2203911	RAMP-MOTOR, RIGHT, 80#
		2203910	RAMP-MOTOR, RIGHT, 112#
128	1	2206550	HOUSING, CONNECTOR WPJ
129	1	2200601	LEADWIRE, TILT MOTOR
130	1	2206421	COVER, TILT ACTUATOR
131	1	2204610	O-RING, TILT, LARGE
132	1	2207810	MOTOR, STOW/DEPLOY
133	1	2201930	MOUNTING PLATE, TILT MOTOR
134	1	2204611	O-RING, TILT, SMALL
135	4	2203400	SCREW-M4 X 8, SS
136	1	2200830	COUPLER, STW/DPLY ACTUATOR
137	1	2202631	SPRING PIN, 5MM X 20MM
138	1	2204620	SEAL, TILT MOTOR
139	2	2201713	WASHER-THRUST, TILT MOTOR
140	1	2200005	BEARING-THRUST, TILT MOTOR
141	1	2201704	SPACER, SHAFT
142	1	2202315	SHAFT, STOW/DEPLOY, SS
143	1	2206425	COVER-NOSE, TILT ACTUATOR
144	4	2373483	SCREW-#8-18 X 5/8" PPH
145	2	2205510	DECAL, SIDEPLATE, FW
146	1	2203900	SIDEPLATE, RIGHT
147	1	2200818	BELT-LIFT 5MM HTD
148	1	2324400	PEDAL, HEEL/TOE FOOT PEDAL
149	1	2326710	PLUG, FOOT PEDAL
150	1	2323710	BUTTON, MOM LEFT, FT PEDAL
151	2	2321300	CLAMP-LEFT, FT PEDAL
152	4	2223430	SCREW-#8 X 3/4 PPH
153	1	2328600	FLEX FINGER, FOOT PEDAL
154	1	2205605	DECAL, 3 INDICATORS
155	1	2200200	COVER, HEEL TOE FOOT PEDAL
156	1	2322900	STRAIN RELIEF, FOOT PEDAL
157	1	2204008	PCB ASSY, FOOT PEDAL
158	1	2323725	BUTTON, AP, FT PEDAL
159	1	2323715	BUTTON, MOM/CON, FT PEDAL
160	1	2204500	BASE PLATE
161	2	2323420	SCREW, #8-18 3/8 PFH SS
162	2	2322706	SPRING-BARREL SS
163	11	2301310	SCREW, #8-18 X 1/2" SS
164	1	2203710	BUTTON, LFT STR W/ TRIM UP ARROW
165	1	2203715	BUTTON, MOMENTARY/STOW-DEPLOY
166	7	2322704	SPRING, LARGE SHORT SS
167	1	2203711	BUTTON, RGT STR W/ TRIM UP ARROW
168	1	2203720	BUTTON, SPOT LOCK
169	1	2203725	BUTTON, MODE
170	1	2320100	KNOB-SPEED, FOOT PEDAL
171	1	2322714	SPRING, MOM ASSIST SS
172	4	3393480	SCREW-#10 X 1.0" PPH HI-LO SS
173	1	2201505	COLLAR, BELT CLAMP
174	1	2200800	BELT-RACK, LOWER
175	1	2201500	COLLAR, CLAMP
176	1	2994740	FOOTPEDAL ASSEMBLY
177	1	2224700	PLUG INSERT (IPILOT)
		2224701	PLUG INSERT (IPILOT LINK)
178	1	2997813	TILT MOTOR ASSY
179	1	2996502	STEERING HOUSING ASSY
180	1	2777098	CTR HSG ASSY, CB, 80#, FW, W/TUBE, 45"
	1	2777099	CTR HSG ASSY, CB, 80#, FW, W/TUBE, 60"
	1	2777248	CTR HSG ASSY, CB, 112#, FW, W/TUBE, 45"
	1	2777249	CTR HSG ASSY, CB, 112#, FW, W/TUBE, 60"
181	1	640-118	LEADWIRE, RED, 80#, 45"
	1	640-132	LEADWIRE, RED, 112#, 45"
	1	640-126	LEADWIRE, RED, 80#, 60"
	1	640-135	LEADWIRE, RED, 112#, 60"
182	1	640-027	LEADWIRE, BLACK, 80#, 45"
	1	640-017	LEADWIRE, BLACK, 112#, 45"
	1	640-022	LEADWIRE, BLACK, 80#, 60"
	1	640-045	LEADWIRE, BLACK, 112#, 60"
183	1	640-315	GROUNDWIRE, BROWN, US2.0, 45"
	1	640-316	GROUNDWIRE, BROWN, US2.0, 60"
184	1	2203800	STRAP, EMERGENCY

ITEM	QTY	PART NUMBER	DESCRIPTION
185	1	2994171	REMOTE ASSY, IPILOT L5
186	1	2994180	REMOTE ASSY, IPILOT LINK *LINK ONLY*
187	1	2370817	LANYARD, REMOTE W/ CARABEENER
188	1	2375901	ADAPTER, USB DC POWER *LINK ONLY*
189	1	2211415	CABLE-EXTENSION, PD/AP 110"
190	1	2373241	CABLE, USB REMOTE CHARGER *LINK ONLY*
191	1	490389	CABLE, ETHERNET, 30' * LINK ONLY*
192	9	2378448	.187 X .125 MAGNET
194	1	2093101	NUT-PROP, NYLOCK, SS
195	1	2091701	WASHER-PROP
196	1	2331160	PROP-WW2, 80#
197	1	2262658	PIN-DRIVE 1" X 3/16" SS
198	2	880-025	SEAL
199	1	725-095	PAPER TUBE, SEAL
200	1	421-070	BRUSH END HSG, 80#
201	1	144-017	BEARING, FLANGE
202	2	830-095	THRU BOLT 12-24
203	1	990-052	WASHER, NYLATRON
204	1	990-051	WASHER-STEEL THRUST
205	2	973-025	SPACER, BRUSHPLATE
206	1	9-738-015	BRUSH PLATE ASSY, 4"
207	2	975-041	SPRING-TORSION
208	2	186-094	BRUSH 4"
209	2	830-027	SCREW-BRUSH PLATE 10-32
210	2	701-009	O-RING, THRU BOLTS
211	2	701-043	O-RING, END HOUSINGS
212	1	2-100-214	ARMATURE ASSEMBLY
213	1	140-010	BEARING - BALL
214	1	990-045	SPACER, THRUST
215	2	992-010	WASHER, SPRING BELLEVILLE
216	1	987-113	TRANSDUCER ASSY US 2.5, 80#, 45"
		987-114	TRANSDUCER ASSY US 2.5, 112#, 45"
		987-116	TRANSDUCER ASSY US 2.5, 80# & 112#, 60"
217	1	421-285	PLAIN END HOUSING MACHINED, SONAR
218	1	230038	CABLE CLAMP, STEEL
219	1	2302104	SCREW-#6 X 3/8
220	1	2341160	PROP-WW2, 112#
221	1	421-150	BRUSH END HSG, 112#
222	2	830-094	THRU BOLT 12-24
223	1	2307312	BEAD-FERRITE
224	1	9-738-011	BRUSH PLATE ASSY, 4.5"
225	2	2053410	SCREW-BRUSH PLATE, 10-32
226	2	975-045	SPRING-TORSION
227	2	188-095	BRUSH, 4.5" LU
228	1	701-107	O-RING, BRUSH END
229	1	701-098	O-RING, PLAIN END
230	1	2-100-245	ARMATURE ASSY.
231	1	140-014	BEARING - BALL
232	2	992-011	WASHER, SPRING BELLEVILLE
233	1	990-011	WASHER, 5HIM
234	1	421-245	PLAIN END HOUSING, ASSY
235	1	582-013	CLIP, RETAINING SHORT
236	1	582-016	CLIP-RETAINING, SONAR
237	1	2218200	FUSE HOLDER ASSY
238	1	2307313	FERRITE BEAD
239	2	2065400	WIRE INSULATOR-LGE 1-3/4, BLUE
240	2	2375400	SHRINK TUBE-1/4 OD X 1-3/4
241	1	2203407	SCREW, #6-32 X .5
242	6	3391732	SEALING WASHER
243	6	3394602	FLAT WASHER #8

PARTS LIST

SERVICE KITS

DESCRIPTION	PART NO.	ITEM NUMBER INCLUDED / QUANTITY
TRIM MOTOR ASSY	2777810	87 (1), 89 (1), 90 (1), 91 (2), 92(1), 93 (1)
TILT BRACKET ASSY	2774201	50 (1), 51 (1), 112 (4), 113 (1), 114 (2), 115 (1), 116 (1)
OUTPUT GEAR W/ MAGNETS	2772200	31 (1), 192 (4)
CAM W/ MAGNET AND SPRING PIN	2777900	122 (1), 123 (1), 192 (1)
PLUNGER W/ MAGNET	2773700	119 (1), 192 (1)
WORM GEAR W/ MAGNET	2772206	192 (1), 193 (2)
WORM SHAFT ASSY W/PULLEY	2772310	64 (1), 65 (1)
MAGNET HOLDER W/ MAGNET	2778601	60 (1), 192 (1)
RELEASE KNOB W/ SCREW	2770100	53 (1), 54 (1)
SENSOR WIRE W/ BUTT CONNECTORS	2880350	
SLIP RING AND CARRIER KIT	2883010	83 (1), 84 (1), 85 (1)
MOUNTING BAG	2994917	

COMPLIANCE STATEMENTS

ENVIRONMENTAL COMPLIANCE STATEMENT:

It is the intention of JOME to be a responsible corporate citizen, operating in compliance with known and applicable environmental regulations, and a good neighbor in the communities where we make or sell our products.

WEEE DIRECTIVE:

EU Directive 2002/96/EC "Waste of Electrical and Electronic Equipment Directive (WEEE)" impacts most distributors, sellers, and manufacturers of consumer electronics in the European Union. The WEEE Directive requires the producer of consumer electronics to take responsibility for the management of waste from their products to achieve environmentally responsible disposal during the product life cycle.

WEEE compliance may not be required in your location for electrical & electronic equipment (EEE), nor may it be required for EEE designed and intended as fixed or temporary installation in transportation vehicles such as automobiles, aircraft, and boats. In some European Union member states, these vehicles are considered outside of the scope of the Directive, and EEE for those applications can be considered excluded from the WEEE Directive requirement.

This symbol (WEEE wheelie bin) on product indicates the product must not be disposed of with other household refuse. It must be disposed of and collected for recycling and recovery of waste EEE. Johnson Outdoors Inc. will mark all EEE products in accordance with the WEEE Directive. It is our goal to comply in the collection, treatment, recovery, and environmentally sound disposal of those products; however, these requirements do vary within European Union member states. For more information about where you should dispose of your waste equipment for recycling and recovery and/or your European Union member state requirements, please contact your dealer or distributor from which your product was purchased.



DISPOSAL:

Minn Kota motors are not subject to the disposal regulations EAG-VO (electric devices directive) that implements the WEEE directive. Nevertheless never dispose of your Minn Kota motor in a garbage bin but at the proper place of collection of your local town council.

Never dispose of battery in a garbage bin. Comply with the disposal directions of the manufacturer or his representative and dispose of them at the proper place of collection of your local town council.

WARNING: This product contains chemicals known to the State of California to cause cancer and birth defects or other reproductive harm.

FCC COMPLIANCE

This device complies with Part 15 of the FCC rules.

Operation is subject to the following two conditions:

1. This device may not cause harmful interference.
2. This device must accept any interference that may be received, including interference that may cause undesired operation.

Changes or modifications not expressly approved by Johnson Outdoors Marine Electronics, Inc. could void the user's authority to operate this equipment.

This product meets the applicable Industry Canada technical specifications. Operation is subject to the following two conditions: (1) this device may not cause interference, and (2) this device must accept any interference, including interference that may cause undesired operation of the device.

Note: This equipment has been tested and found to comply with the limits for a Class B digital device, pursuant to part 15 of the FCC Rules. These limits are designed to provide reasonable protection against harmful interference in a residential installation. This equipment generates, uses and can radiate radio frequency energy and, if not installed and used in accordance with the instructions, may cause harmful interference to radio communications. However, there is no guarantee that interference will not occur in a particular installation. **If this equipment does cause harmful interference to radio or television reception, which can be determined by turning the equipment off and on, the user is encouraged to try to correct the interference by one or more of the following measures:**

- Reorient or relocate the receiving antenna.
- Increase the separation between the equipment and receiver.
- Connect the equipment into an outlet on a circuit different from that to which the receiver is connected.
- Consult the dealer or an experienced radio/TV technician for help.

TRANSMITTER MODEL: 2990206

- IC: 4397A-ULTERRAIP15
- FCC ID: T62-ULTERRAIP15

TRANSMITTER MODEL: 2990208

- IC: 4397A-ULTERRA20
- FCC ID: T62-ULTERRA20

RECOMMENDED ACCESSORIES

ON-BOARD & PORTABLE BATTERY CHARGERS

Stop buying new batteries and start taking care of the ones you've got. Many chargers can actually damage your battery over time – creating shorter run times and shorter overall life. Digitally controlled Minn Kota chargers are designed to provide the fastest charge that protect and extend battery life.



MK345PC



MK210D



MK110P

TALON SHALLOW WATER ANCHOR

Talon deploys faster, holds stronger and runs quieter than any other shallow water anchor. Available in depths up to 12' and bold color options, it boasts an arsenal of features and innovations that no other anchor can touch:



- Vertical, multi-stage deployment
- User-Selectable Anchoring Modes
- 2x Anchoring Force
- Fast Deploy
- Auto Up/Down

- Triple Debris shields*
- Built-In Wave Absorption
- Noise Dissipation
- Versatile Adjustments

*available on 10' and 12' models only

MINN KOTA ACCESSORIES

We offer a wide variety of trolling motor accessories, including:



- 60-Amp Circuit Breaker
- Mounting Brackets
- Stabilizer Kits
- Extension Handles
- Battery Connectors
- Battery Boxes
- Quick Connect Plugs

For a complete listing of Minn Kota accessories, visit minnkotamotors.com

Follow us:



minnkotamotors.com

Minn Kota Consumer & Technical Service
Johnson Outdoors Marine Electronics, Inc.
PO Box 8129
Mankato, MN 56001

121 Power Drive
Mankato, MN 56001
Phone (800) 227-6433
Fax (800) 527-4464



©2014 Johnson Outdoors Marine Electronics, Inc.
All rights reserved.