

FURUNO

GPS Navigator

Model **GP-39**



OPERATOR'S MANUAL



FURUNO ELECTRIC CO., LTD.

www.furuno.com

ECF

(Elemental Chlorine Free)

The paper used in this manual
is elemental chlorine free.

FURUNO ELECTRIC CO., LTD.

9-52 Ashihara-cho,
Nishinomiya, 662-8580, JAPAN

• FURUNO Authorized Distributor/Dealer

All rights reserved. Printed in Japan

Pub. No. OME-44940-A2

(TASU) GP-39

A : FEB. 2016

A2 : JUN. 22, 2016



0 0 0 1 9 1 4 2 1 1 0

IMPORTANT NOTICE

General

- This manual has been authored with simplified grammar, to meet the needs of international users.
- The operator of this equipment must read and follow the descriptions in this manual. Wrong operation or maintenance can cancel the warranty or cause injury.
- Do not copy any part of this manual without written permission from FURUNO.
- If this manual is lost or worn, contact your dealer about replacement.
- The contents of this manual and equipment specifications can change without notice.
- The example screens (or illustrations) shown in this manual can be different from the screens you see on your display. The screens you see depend on your system configuration and equipment settings.
- Save this manual for future reference.
- Any modification of the equipment (including software) by persons not authorized by FURUNO will cancel the warranty.
- All brand and product names are trademarks, registered trademarks or service marks of their respective holders.

How to discard this product

Discard this product according to local regulations for the disposal of industrial waste. For disposal in the USA, see the homepage of the Electronics Industries Alliance (<http://www.eiae.org/>) for the correct method of disposal.

How to discard a used battery

Some FURUNO products have a battery(ies). To see if your product has a battery(ies), see the chapter on Maintenance. Follow the instructions below if a battery(ies) is used. Tape the + and - terminals of battery before disposal to prevent fire, heat generation caused by short circuit.

In the European Union

The crossed-out trash can symbol indicates that all types of batteries must not be discarded in standard trash, or at a trash site. Take the used batteries to a battery collection site according to your national legislation and the Batteries Directive 2006/66/EU.

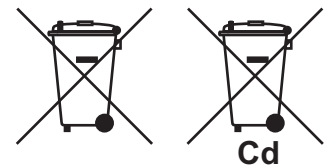

In the USA

The Mobius loop symbol (three chasing arrows) indicates that Ni-Cd and lead-acid rechargeable batteries must be recycled. Take the used batteries to a battery collection site according to local laws.

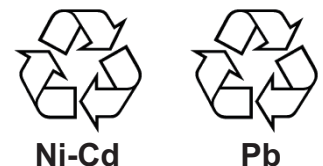

In the other countries

There are no international standards for the battery recycle symbol. The number of symbols can increase when the other countries make their own recycle symbols in the future.



SAFETY INSTRUCTIONS

The operator and installer must read the applicable safety instructions before attempting to operate or install the equipment.



WARNING

Indicates a potentially hazardous situation which, if not avoided, could result in death or serious injury.



CAUTION

Indicates a potentially hazardous situation which, if not avoided, can result in minor or moderate injury.



Warning, Caution



Prohibitive Action



Mandatory Action



WARNING



Do not disassemble or modify the equipment.

Fire, electrical shock or serious injury can occur.



Turn off the power immediately if water leaks into the equipment or the equipment is emitting smoke or fire.

Continued use of the equipment can cause fire or electrical shock.



Turn off the power at the mains switchboard before beginning the installation.

Fire, electrical shock or serious injury can result if the power is left on or is applied while the equipment is being installed.



Be sure that the power supply is compatible with the voltage rating of the equipment.

Connection of an incorrect power supply can cause fire or equipment damage. The voltage rating of the equipment appears on the label above the power connector.



Observe the following safe compass distances to prevent interference to a magnetic compass:

	Standard compass	Steering compass
GP-39	0.60 m	0.40 m



WARNING



Do not install the equipment where it may get wet from rain or water splash.

Water in the equipment can result in fire, electrical shock or damage to the equipment.



CAUTION



The glass of an LCD panel breaks easily. Handle the LCD carefully.

Injury can result if the glass breaks.



No single navigation aid (including this unit) should ever be relied upon as the exclusive means for navigating your vessel.



The navigator is responsible for checking all aids available to confirm his position. Electronic aids are intended to assist, not replace, the navigator.



Ground the equipment to prevent electrical shock and mutual interference.

TABLE OF CONTENTS

FOREWORD	v
SYSTEM CONFIGURATION	vi
1. OPERATIONAL OVERVIEW	1-1
1.1 Controls	1-1
1.2 How to Turn Power On/Off	1-2
1.3 How to Adjust LCD and Key Panel Brilliance	1-3
1.4 Display Modes	1-3
1.5 Menu Overview.....	1-8
1.6 How to Enter the MOB Mark.....	1-10
2. PLOTTER DISPLAY OVERVIEW	2-1
2.1 How to Select the Display Range	2-1
2.2 How to Shift the Cursor	2-1
2.3 How to Shift the Display	2-2
2.4 How to Display/Hide Track and COG Line	2-2
2.5 How to Change Track Plotting Interval, Stop Recording	2-3
2.6 How to Change Track Color	2-4
2.7 How to Erase Track.....	2-4
2.7.1 How to erase track by color.....	2-4
2.7.2 How to erase all tracks	2-5
3. WAYPOINTS	3-1
3.1 How to Enter Waypoints	3-1
3.1.1 How to enter a waypoint with the cursor	3-1
3.1.2 How to enter a waypoint at own ship position	3-1
3.1.3 How to enter a waypoint through the list	3-1
3.1.4 How to enter waypoints automatically	3-3
3.2 How to Display Waypoint Name	3-4
3.3 How to Edit Waypoints	3-5
3.3.1 How to edit waypoints on the plotter display	3-5
3.3.2 How to edit waypoints through the list.....	3-5
3.4 How to Move Waypoints.....	3-6
3.5 How to Erase Waypoints	3-6
3.5.1 How to erase a waypoint on the plotter display.....	3-6
3.5.2 How to erase a waypoint through the waypoint list	3-6
3.5.3 How to erase all waypoints.....	3-7
4. ROUTES	4-1
4.1 How to Create Routes	4-1
4.2 How to Edit Routes.....	4-3
4.2.1 How to replace a waypoint in a route	4-3
4.2.2 How to delete a waypoint from a route.....	4-3
4.2.3 How to insert a waypoint in a route	4-4
4.2.4 How to temporarily deselect a waypoint in a route.....	4-4
4.3 How to Erase a Route	4-5
4.3.1 How to erase a route through the route list	4-5
4.3.2 How to erase all routes.....	4-5

5. DESTINATION	5-1
5.1 How to Set Destination by Cursor Position	5-1
5.2 How to Set Destination by Waypoint.....	5-2
5.2.1 How to set a destination waypoint with the cursor	5-2
5.2.2 How to set a destination waypoint from the list.....	5-2
5.3 How to Set Route as Destination	5-3
5.4 How to Cancel a Destination.....	5-4
5.4.1 How to cancel a destination with the cursor.....	5-4
5.4.2 How to cancel a destination through the list.....	5-4
5.5 How to Set a Destination from Other Displays.....	5-5
6. ALARMS	6-1
6.1 Overview	6-1
6.2 Buzzer Type Selection	6-2
6.3 How to Set an Alarm	6-3
6.4 Alarm Descriptions	6-4
7. OTHER FUNCTIONS	7-1
7.1 Plotter Setup Menu	7-1
7.2 Delete Menu.....	7-2
7.3 GPS Setup Menu	7-2
7.4 WAAS Menu.....	7-4
7.5 Position Display Format	7-4
7.6 System Menu	7-5
7.7 User Display Menu.....	7-7
7.8 I/O Setup Menu	7-10
7.8.1 Uploading data to a USB flash memory.....	7-12
7.8.2 Downloading data from a USB flash memory	7-12
7.8.3 Importing data from GP-32.....	7-13
8. MAINTENANCE, TROUBLESHOOTING.....	8-1
8.1 Maintenance.....	8-1
8.2 Troubleshooting	8-2
8.3 Displaying the Message Board	8-3
8.4 Diagnostics.....	8-3
8.5 Clearing Data	8-4
9. INSTALLATION	9-1
9.1 Equipment Lists.....	9-1
9.2 Installation of Display Unit.....	9-1
9.2.1 Installation consideration.....	9-1
9.2.2 Desktop mount.....	9-2
9.2.3 Flush mount	9-3
9.3 Installation of Antenna Unit	9-5
9.4 Language Setting	9-5
9.5 Input/Output Data.....	9-6
APPENDIX 1 MENU TREE	AP-1
APPENDIX 2 WHAT IS SBAS?	AP-3
APPENDIX 3 LIST OF TERMS	AP-4
APPENDIX 4 GEODETIC CHART LIST	AP-5
SPECIFICATIONS	SP-1
PACKING LISTS.....	A-1
OUTLINE DRAWINGS.....	D-1
INTERCONNECTION DIAGRAM	S-1
INDEX.....	IN-1

FOREWORD

A Word to the Owner of the GP-39

Congratulations on your choice of the GP-39 GPS Navigator.

Since 1948, FURUNO Electric Company has enjoyed an enviable reputation for innovative and dependable marine electronics is furthered by our extensive global network of agents and dealers.

Your navigator is designed and constructed to meet the rigorous demands of the marine environment. However, no machine can perform its intended function unless installed, operated and maintained properly. Please carefully read and follow the recommended procedures for installation, operation and maintenance.

We would appreciate feedback from you, the end-user, about where we are achieving our purposes.

Thank you for considering and purchasing FURUNO equipment.

Features

The main features of the GP-39 are as shown below.

- High-resolution color LCD
- WAAS capability
- Storage for 10,000 waypoints, 100 routes and 3,000 track points
- Alarms: Arrival/Anchor, XTE (Cross-track Error), Trip, Odometer, Time, WAAS and Speed
- Man overboard feature records position at time of man overboard and provides continuous updates of range and bearing when navigating to the MOB position.
- Unique Highway display provides a graphic presentation of boat's progress toward a waypoint.
- User-programmable nav data displays provide analog and digital navigation data.
- Navigation data output to the autopilot when connecting.
- Waypoint and route data can be uploaded/downloaded via a USB flash memory* to the GP-39.
* USB flash memory is a trade mark of USB Implementers Forum, Inc.

Program No.

Name	No.	Ver.
CPU MAIN	2051584-**. **	December, 2015
CPU Boot	2051583-**. **	December, 2015
GPS	4850465014	December, 2015

** : Minor change

With regards to CE declarations, please refer to our website (www.furuno.com), for further information on RoHS conformity declarations.

SYSTEM CONFIGURATION

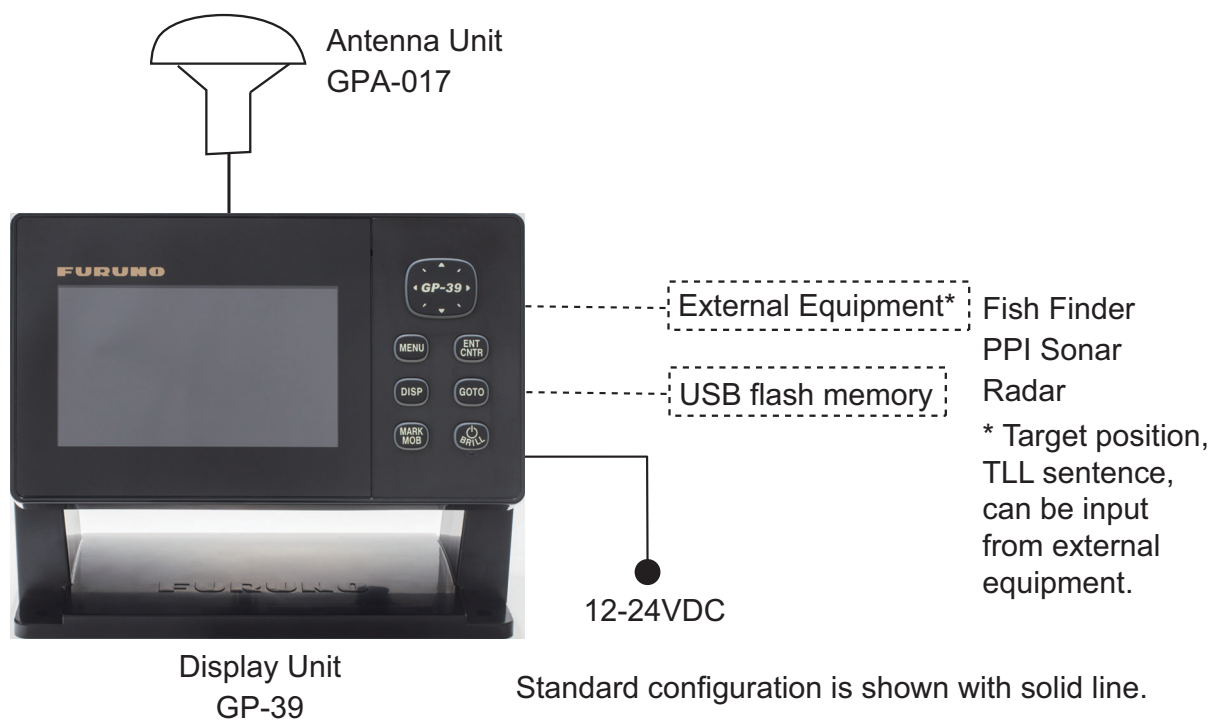







Category of Units

Units	Category
Antenna Unit GPA-017	Exposed to the weather.
Display Unit GP-39	Protected from the weather.

1. OPERATIONAL OVERVIEW

1.1 Controls



Key	Description
 (Cursorpad)	<ul style="list-style-type: none"> - Shifts the cursor. - Selects item on menus.
	<ul style="list-style-type: none"> - Opens the Menu. (For plotter and highway displays, press twice, For other displays, press once) - Shows the zoom window (plotter and highway displays only).
	<ul style="list-style-type: none"> - Long press: Returns own ship position to center (plotter display only). - Momentary press: Confirms selection on menus.
	Selects display mode.
	Sets destination.
	<ul style="list-style-type: none"> - Long press: Inscribes MOB mark. - Momentary press: Registers own ship position as waypoint.
	<ul style="list-style-type: none"> - Long press: Turns power off. - Momentary press: Turns power on./Shows Brill window.

1. OPERATIONAL OVERVIEW

How to detach the hard cover from the unit

Put your thumbs on the front of the cover and forefingers at its back edge, and pull it toward you.

Press here with thumb and pull cover forward.

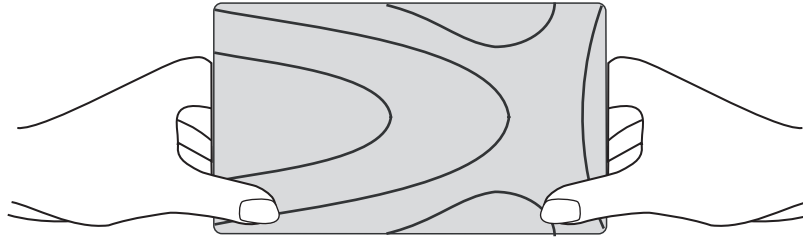

1.2 How to Turn Power On/Off

1. Press the ϕ /**BRILL** key to turn on the power. The unit beeps and then starts up with the last-used display mode. Your equipment takes about 90 seconds to find its position. The equipment shows receiver status indication at the top left-hand corner in most display modes. The table below shows these indications and their meanings.

Status indications

Indication	Meaning
2D	2D GPS position fixed
3D	3D GPS position fixed
W2D	2D WAAS position fixed
W3D	3D WAAS position fixed
DOP*	2D: HDOP larger than 4 3D: PDOP larger than 6
SIM	Simulation mode
- - -	Not fixed

*: DOP (Dilution of Precision) is the index of position accuracy, and it is the distribution pattern of satellites used in position fixing. Generally, the smaller the figure the better the position accuracy. (HDOP: Horizontal DOP, PDOP: Position DOP)

2. To turn off the power, press and hold down the ϕ /**BRILL** key for three seconds. The time remaining until the power is turned off is counted down on the display.

Note: The screen refreshes slower in low ambient temperature.

1.3 How to Adjust LCD and Key Panel Brilliance

1. Press the  /BRILL key to show the following window.

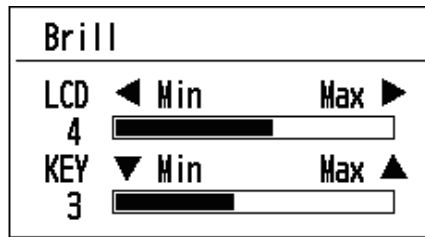

2. To adjust the LCD brilliance, press  /BRILL key. The setting changes "0→1→...→7→6...0→1..." continuously. Maximum setting is 7. You can use also the cursorpad (◀, ▶) to adjust the brilliance.
3. To adjust the panel brilliance, press the cursorpad (▲, ▼, max: 7).
4. Press **ENT/CNTR** or **MENU** key.

1.4 Display Modes

Your unit has seven display modes: Plotter Display, Highway Display, Steering Display, Nav Data Display, Satellite Monitor Display and User Display 1 and User Display 2. Press the **DISP** key to select a display mode. Each time the key is pressed, the display mode changes in the sequence shown below. To step through the displays in reverse order, press the **DISP** key more than three seconds.

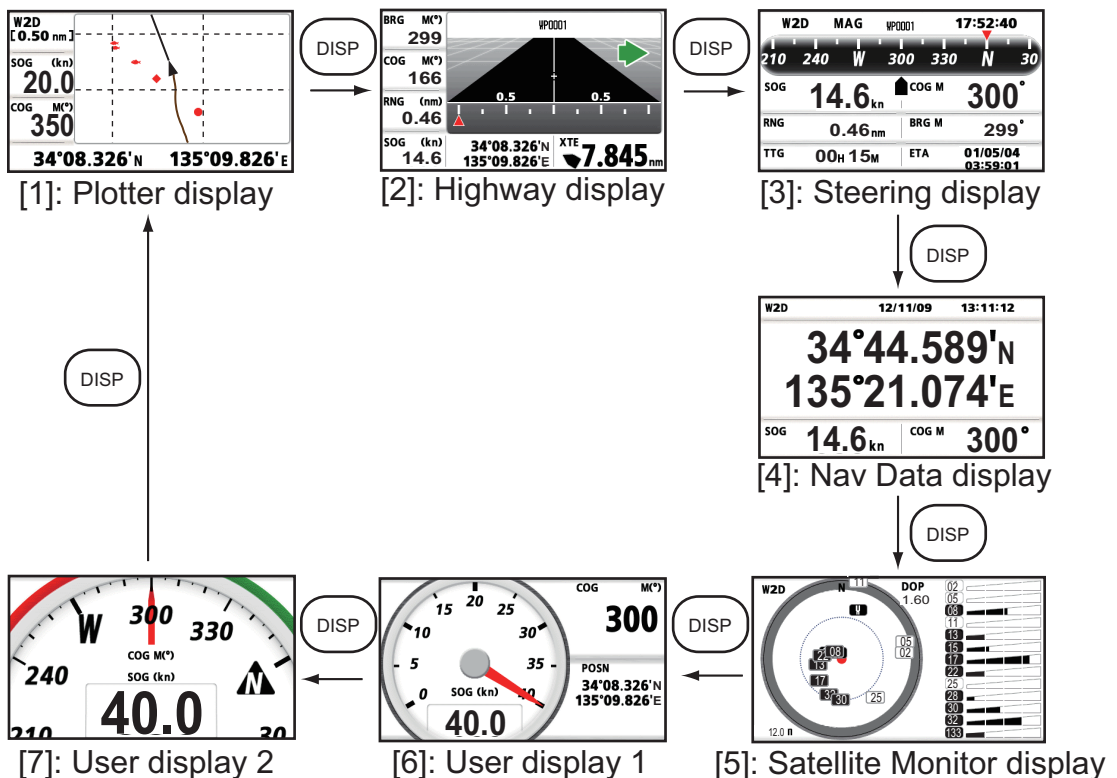

1. OPERATIONAL OVERVIEW

Plotter Display

The plotter display traces own ship's track.

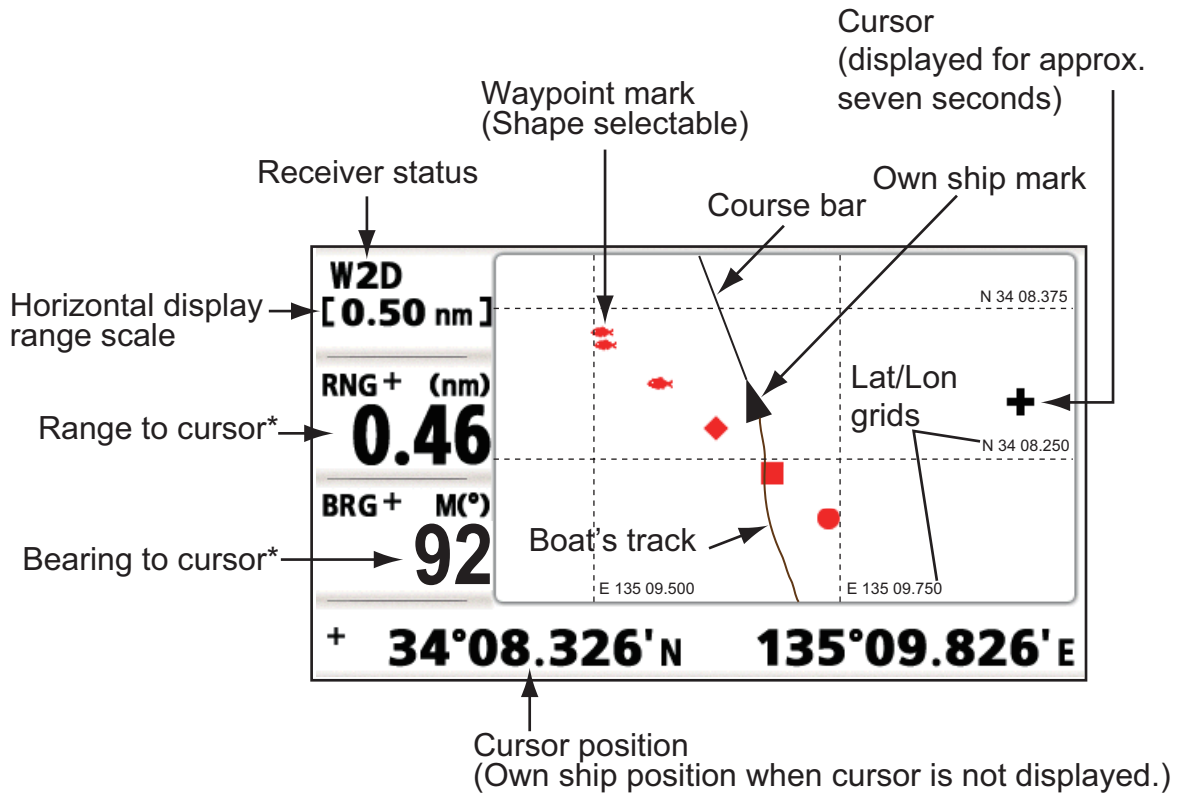

*:COG and SOG replace bearing to cursor and range to cursor when the cursor is not displayed.

Highway Display

The highway display provides a 3D view of own ship's progress toward destination.

XTE (Cross-track error) scale and arrow mark
 Arrow shifts with boat's XTE. When the arrow is aligned with the center line the boat is on course. The arrow blinks if boat's XTE is greater than XTE scale range.

"N (North)" is displayed, instead of the arrow, at the center of the scale when no destination is set.

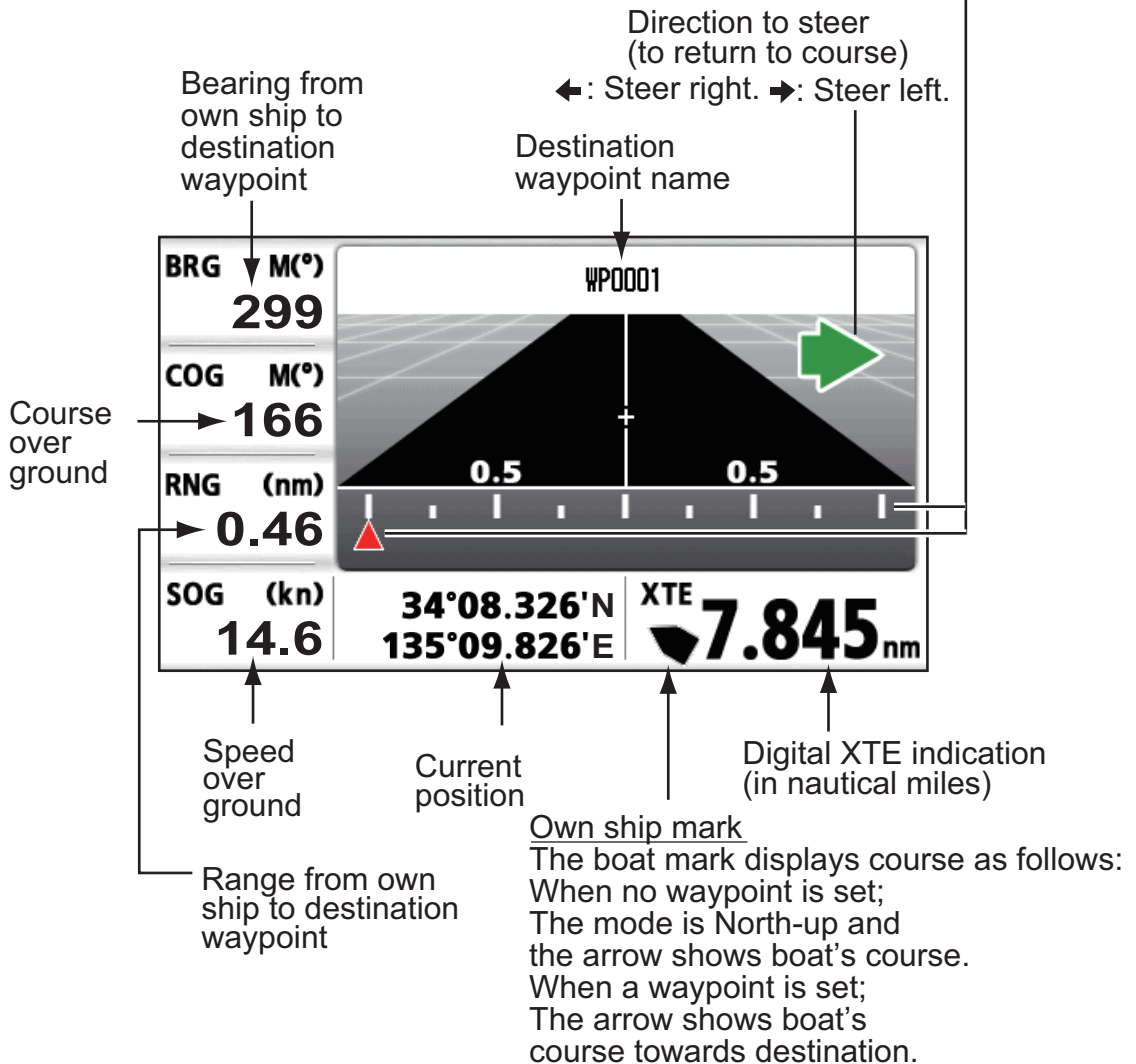

1. OPERATIONAL OVERVIEW

Steering Display

The steering display provides steering information.

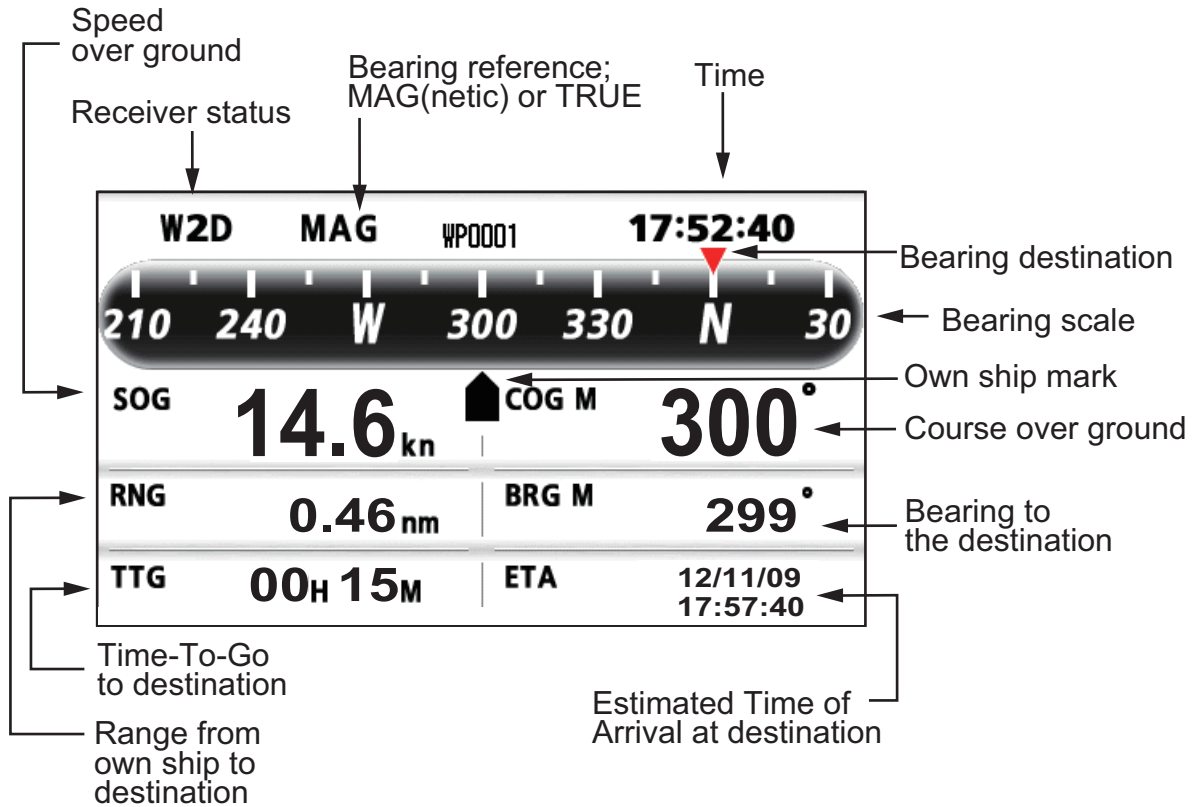

Nav Data Display

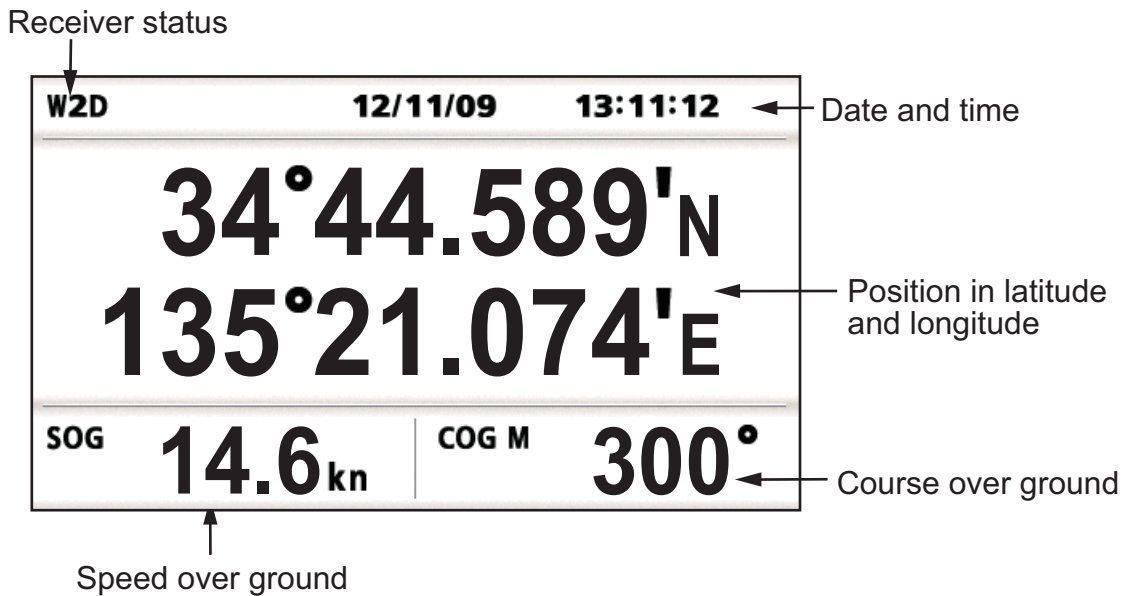

Satellite Monitor Display

The satellite monitor display shows the condition of GPS and GEO (WAAS) satellites. Number, bearing and elevation angle of all GPS and GEO satellites (if applicable) in view of your receiver appear.

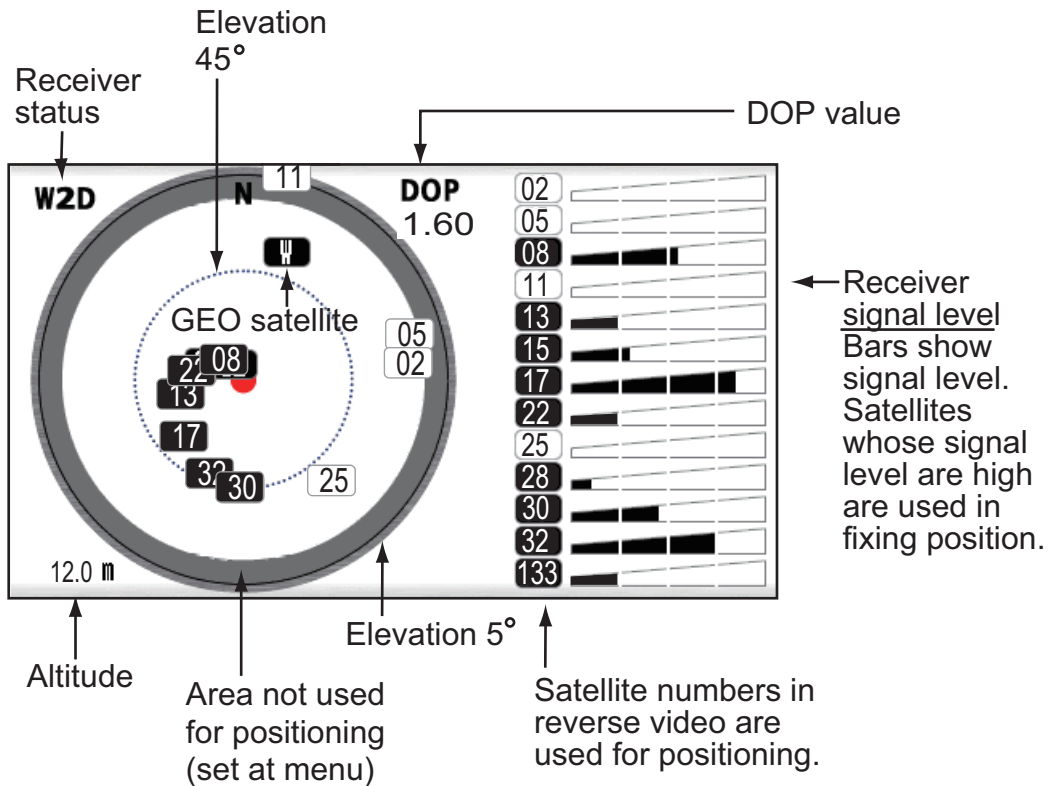

User Display 1 and User Display 2

- Digital display
The digital display shows digital navigation data. You can select what data to display in one to four cells. The choices of data are odometer distance, trip distance, time, date, position, power source voltage, speed over ground, course over ground, range, bearing, cross-track-error, time-to-go to a destination, estimated time of arrival at destination, waypoint and none.
- Speedometer display
The speedometer display provides both digital and analog displays of speed over ground.
- COG display
The COG display shows both analog course over ground, and digital speed over ground.

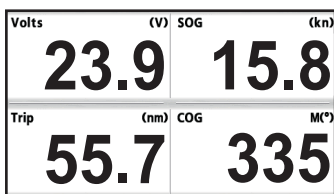

Digital display (four cells)

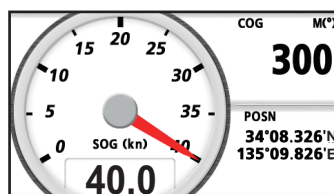

Speedometer display (default: User display 1)



COG display (default: User display 2)

1.5 Menu Overview

Most operations of your unit are done through the menu. Below is a quick introduction on how to select a menu and change menu settings. If you get lost in operation, press the **MENU** key to return to the main menu.

1. Press the **MENU** key once or twice to display the main menu.
 Press once: Steering display, nav data display, satellite monitor display, user display 1 and user display 2.
 Press twice: Plotter display, highway display.

Note: Following explanation takes the menus for the plotter display as an example.

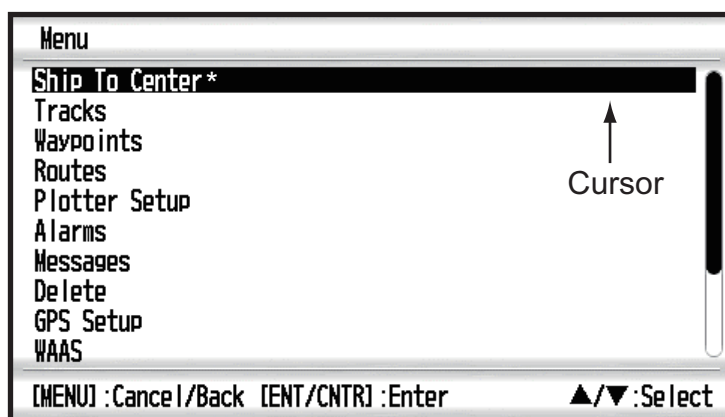

*: Shown only when the **MENU** key is pressed at the plotter display.

2. Press **▲** or **▼** to select an item, and press the **ENT/CNTR** key.
3. Press **ENT/CNTR** (or **▶**) key.
 For example, select [Plotter Setup] and press the **ENT/CNTR** key.

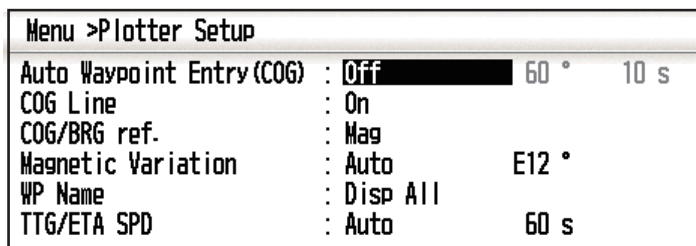

4. Press **▲** or **▼** to select option desired.
 For example, select [COG/BRG ref.]
5. Press the **ENT/CNTR** key (or **▶**).
 A window appears showing the options for the selected item.



6. Press **▲** or **▼** to select option desired.
7. Press the **ENT/CNTR** key (or **▶**).
8. Press the **MENU** key (or **◀**) twice to close the menu.

How to enter alphanumeric data

Some menu operations require you to enter alphanumeric data (A to Z, 0 to 9) and symbols (&, _, #, ' , - , > and space). The procedure which follows shows how to enter alphanumeric data. For example, to change the waypoint name "WP0006" to "KOB", do as follows:

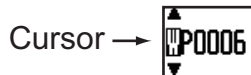

- 1) Press ▲ or ▼ to select "K".
- 2) Press ►, and press ▲ or ▼ to select "O".
- 3) Press ►, and press ▲ or ▼ to select "B".
- 4) Press ►, and press ▲ or ▼ to select "E".
- 5) Press ►, and press ▲ or ▼ to select " "(space).
- 6) Press ►, and press ▲ or ▼ to select " " (space).
- 7) Press the **ENT/CNTR** key.

1.6 How to Enter the MOB Mark

The MOB mark denotes man overboard position. Only one MOB mark is displayed. Each time the MOB mark is entered the previous MOB mark and its position data are overwritten.

1. Press the **MARK/MOB** key until the following message appears.

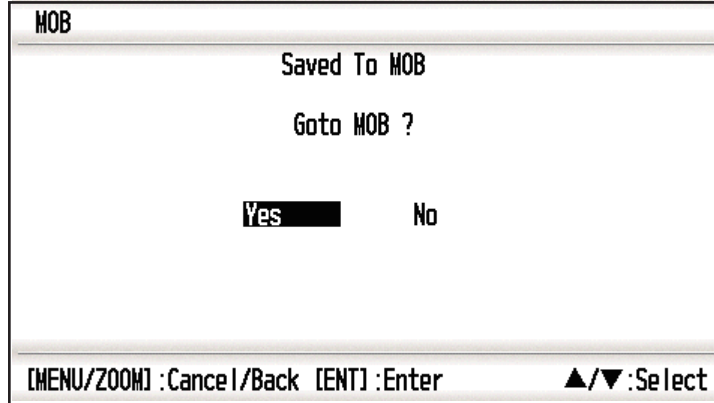

2. To set the MOB position as the destination, confirm that [Yes] is selected and press the **ENT/CNTR** key. MOB mark ("M") appears and a blue line is drawn between own ship mark and the MOB mark. This line shows the shortest course to go to the MOB position, and arrows on the line show the direction to the MOB position.

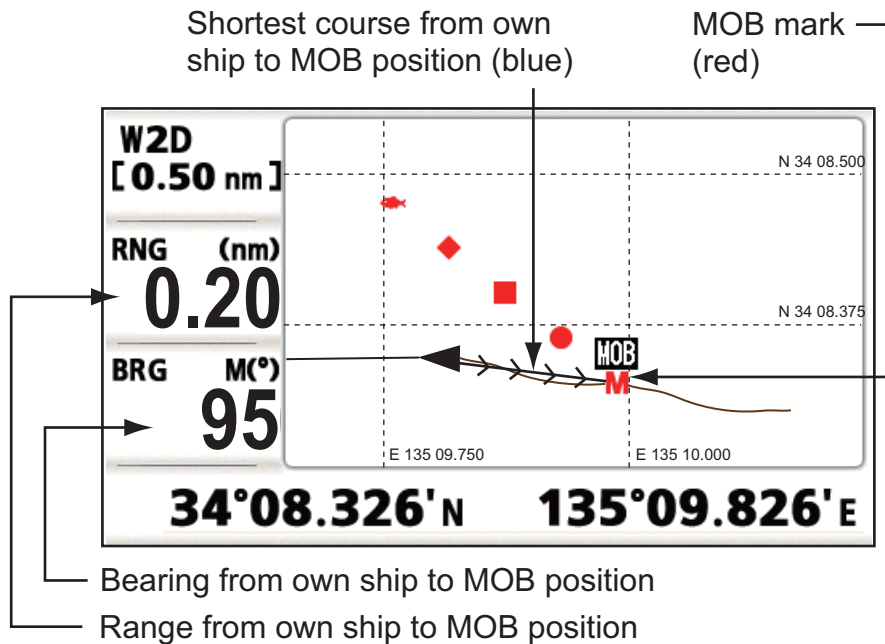

2. PLOTTER DISPLAY OVERVIEW

2.1 How to Select the Display Range

You can change the display range on the plotter and highway displays. The available horizontal range for the plotter display is: 0.02, 0.05, 0.1, 0.2, 0.5, 1, 2, 5, 10, 20, 40, 80, 160 and 320 nautical miles. The available horizontal range for the highway display is: 0.2, 0.4, 0.8, 1, 2, 4, 8 and 16 nautical miles.

1. Press the **MENU** key on the plotter or highway display.
The following window appears.

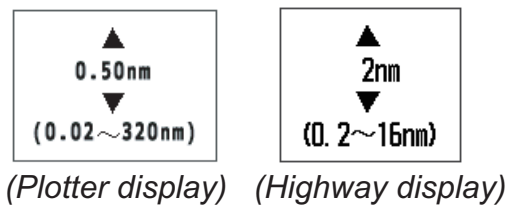

2. Press **▲** or **▼** to select range you want.
3. Press the **ENT/CNTR** key.

2.2 How to Shift the Cursor

Use the cursorpad to shift the cursor. The cursor moves in the direction of the arrow or diagonal.

Cursor state and position indication

The position indication, shown at bottom of the plotter display, changes according to cursor state.

Cursor at rest

When the cursor is not shown, boat's position in longitude and latitude or TDs (depending on the menu setting) appears at the bottom of the display.

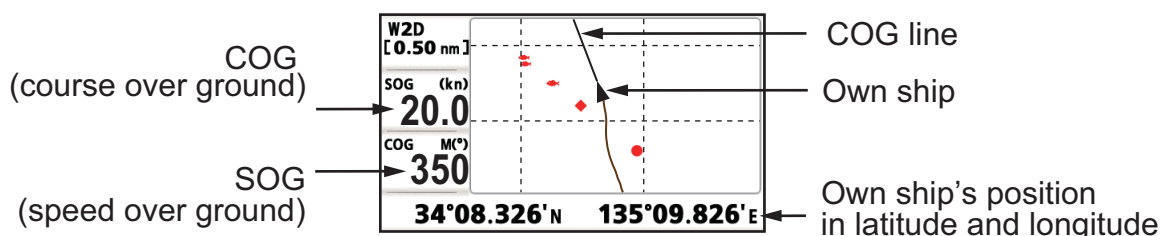

2. PLOTTER DISPLAY OVERVIEW

Cursor state and position indication

Cursor position is displayed in latitude and longitude or TDs at the bottom of the plotter display when the cursor is shown.

If there is no operation for about seven seconds, the cursor disappears.

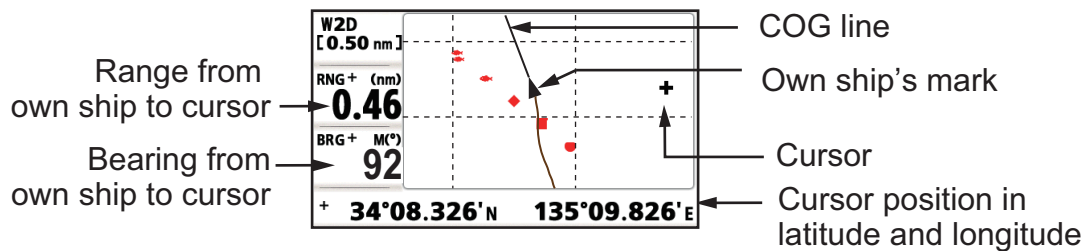

2.3 How to Shift the Display

The display can be shifted on the plotter display.

1. Press the cursorpad to show the cursor.
2. Press and hold down an arrow on the cursorpad.
When the cursor is placed at an edge of the screen, the display shifts in the direction opposite to cursorpad operation.

Centering own ship's position

When own ship tracks off the plotter display, the own ship mark is automatically returned to the screen center. You can also return it manually by pressing and holding the **ENT/CNTR** key for more than three seconds.

2.4 How to Display/Hide Track and COG Line

The own ship's track and COG line can be displayed or hidden separately on the plotter display.

1. Press the cursorpad to show the cursor.
2. Operate the cursorpad to place the cursor on the own ship mark.
3. Press the **ENT/CNTR** key to show the pop-up window.
The default setting is On for Track and COG Line, so the following pop-up window for Off setting appears.



4. Select [Track Off] or [COG Line Off] to hide the track or COG line, and press the **ENT/CNTR** key. To display the track or COG line, select [Track On] or [COG Line On] and press the **ENT/CNTR** key.

2.5 How to Change Track Plotting Interval, Stop Recording

To trace the boat's track, the boat's position is stored into the memory at an interval of distance or according to display range. For distance, a shorter interval provides better reconstruction of the track, but the storage time of the track is shortened. When the track memory becomes full, the oldest track is erased to make room for the latest. The current percentage of the memory used can be confirmed by choosing [Tracks] on the menu.

1. Press the **MENU** key twice to show the main menu.
2. Select [Tracks], and press the **ENT/CNTR** key.

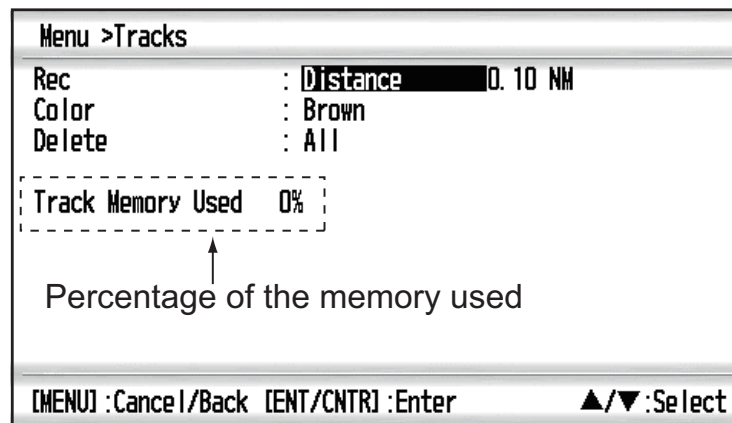

3. Confirm that the [Rec] is selected, and press the **ENT/CNTR** key.

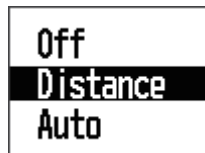

4. Select [Off], [Distance] or [Auto], and press the **ENT/CNTR** key.
 Off: Track is not recorded. This setting is useful when you do not need to record track.
 Distance: Track is recorded and plotted at the distance interval set.
 Auto: Plotting and recording interval changes with display range selected.
5. For [Off] or [Auto], go to step 6. For [Distance], enter the recording interval as follows:
 - 1) Press ►.
 - 2) Press **ENT/CNTR** key.



- 3) Use the cursorpad to enter the interval, and press the **ENT/CNTR** key.
 For entering the numeric data, see page 1-9.
6. Press the **MENU** key twice to close the menu.

2.6 How to Change Track Color

You can select the color for the tracks among red, yellow, green, blue, purple, black and brown. It is useful to change the color to distinguish tracks at different times of a day, for example.

1. Press the **MENU** key twice to show the main menu.
2. Select [Tracks], and press the **ENT/CNTR** key.
3. Select [Color], and press the **ENT/CNTR** key.



4. Select the color to use for the track, and press the **ENT/CNTR** key.
5. Press the **MENU** key twice to close the menu.

2.7 How to Erase Track

The tracks can be erased collectively or by color. The tracks cannot be restored once erased, therefore be absolutely sure you want to erase the tracks.

2.7.1 How to erase track by color

1. Press the **MENU** key twice to show the main menu.
2. Select [Tracks], and press the **ENT/CNTR** key.
3. Select [Delete], and press the **ENT/CNTR** key.

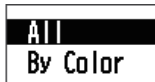

4. Select [By Color], and press the **ENT/CNTR** key.

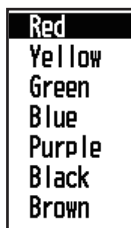

5. Select the track color to erase, and press the **ENT/CNTR** key. The window shown below appears.

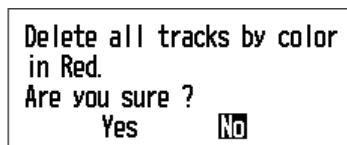

6. Press **◀** to select [Yes], and press the **ENT/CNTR** key. The tracks with the color selected at step 5 are erased. **Note:** To cancel, select [No] at this step.
7. Press the **MENU** key twice to close the menu.

2.7.2 How to erase all tracks

1. Press the **MENU** key twice to show the main menu.
2. Select [Tracks], and press the **ENT/CNTR** key.
3. Select [Delete], and press the **ENT/CNTR** key.
4. Select [All], and press the **ENT/CNTR** key.

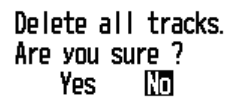

Delete all tracks.
Are you sure ?
Yes 

5. Press ◀ to select [Yes], and press the **ENT/CNTR** key to erase all tracks. [Track Memory Used] on the Tracks menu shows “0%”.
6. Press the **MENU** key twice to close the menu.

2. PLOTTER DISPLAY OVERVIEW

This page is intentionally left blank.

3. WAYPOINTS

3.1 How to Enter Waypoints

In navigation terminology a waypoint is a particular location on a voyage, whether it be a starting, intermediate or destination waypoint. Your unit can store 10,000 waypoints. Waypoints can be entered on the plotter display: at cursor position, at own ship's position, through the waypoints list and at the MOB position. Also, waypoints can be entered automatically when your boat changes course prominently.

3.1.1 How to enter a waypoint with the cursor

1. Use the cursorpad to place the cursor on the location desired for a waypoint.
2. Press the **ENT/CNTR** key to enter the waypoint mark (default shape: green solid circle). This waypoint is named with the youngest unused waypoint number, and saved to the waypoint list.

3.1.2 How to enter a waypoint at own ship position

Press the **MARK/MOB** key to enter the waypoint mark (default shape: green solid circle). This waypoint is named with the youngest unused waypoint number, and saved to the waypoint list.

3.1.3 How to enter a waypoint through the list

1. Press the **MENU** key to show the main menu.
2. Select [Waypoints], and press the **ENT/CNTR** key.
3. Select [Alpha] or [Distance], and press the **ENT/CNTR** key.



4. Press the **ENT/CNTR** key to show the waypoint list.

Menu >Waypoints >Waypoint List				
Name	Symbol	Color	RNG (NM)	BRG (°)
[New]				
G WPO001	●	Red	1.11	167
WPO002	■	Red	0.83	171
WPO003	◆	Red	0.70	175
WPO004	⦿	Red	0.64	177
WPO005	⦿	Red	0.60	178

[MENU] :Cancel/Back [ENT/CNTR] :Enter ▲/▼:Select

3. WAYPOINTS

5. Confirm that [New] is selected, and press the **ENT/CNTR** key.

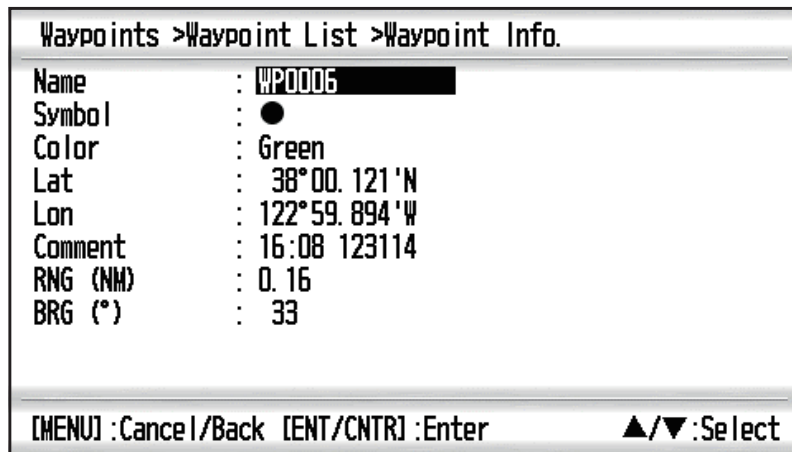

The default name, Lat/Lon and Comment are as follows:

Name: The youngest unused waypoint number.

Lat, Lon: Current own ship position

Comment: Current date/time

6. To change the waypoint name, press the **ENT/CNTR** key.

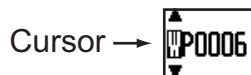

7. Operate the cursorpad to change the waypoint name (max. 8 characters).
8. To change the mark shape, select [Symbol] and press the **ENT/CNTR** key.



9. Select a mark desired, and press the **ENT/CNTR** key.
10. To change the mark color, select [Color], and press the **ENT/CNTR** key.



11. Select a color desired, and press the **ENT/CNTR** key.
12. To change the position, do as follows:
 - 1) Select [Lat], and press the **ENT/CNTR** key.
 - 2) Enter the latitude, and press the **ENT/CNTR** key.
 - 3) Press ▼ to select [Lon], and press the **ENT/CNTR** key.
 - 4) Enter the longitude, and press the **ENT/CNTR** key.

13. To change the comment, select [Comment] and press the **ENT/CNTR** key.
14. Enter the comment, and press the **ENT/CNTR** key.
15. Press the **MENU** key to register the new waypoint into the list.
16. To register other waypoints, repeat steps 4 through 14.
17. Press the **MENU** key several times to close the menu.

3.1.4 How to enter waypoints automatically

Waypoints can be entered automatically when your course changes by a specified degree. This function is useful for following the recorded waypoints on an outward voyage in reverse when you return home. To set the criteria for automatic entering of waypoints, do the following:

1. Press the **MENU** key twice to show the main menu.
2. Select [Plotter Setup], and press the **ENT/CNTR** key.

Menu >Plotter Setup			
Auto Waypoint Entry (COG)	: Off	60 °	10 s
COG Line	: On		
COG/BRG ref.	: Mag		
Magnetic Variation	: Auto	E12 °	
WP Name	: Disp All		
TTG/ETA SPD	: Auto	60 s	

3. Select [Auto Waypoint Entry (COG)], and press the **ENT/CNTR** key.
4. Select [On], and press the **ENT/CNTR** key.
5. Press ► to select the degree setting, and press the **ENT/CNTR** key.
6. Enter the degree, and press the **ENT/CNTR** key (setting range: 15 to 150°).
7. Press ► to select the seconds setting, and press the **ENT/CNTR** key.
8. Enter the seconds, and press the **ENT/CNTR** key (setting range: 1 to 60 seconds).
9. Press the **MENU** key twice to close the menu.

3.2 How to Display Waypoint Name

You can display waypoint names as follows:

1. Press the **MENU** key twice to show the main menu.
2. Select [Plotter Setup], and press the **ENT/CNTR** key.

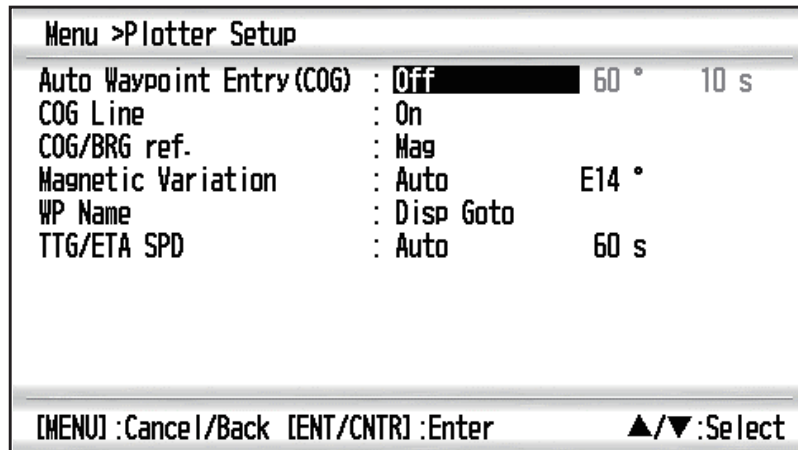

3. Select [WP Name], and press the **ENT/CNTR** key.

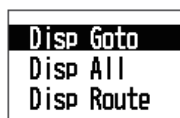

4. Select [Disp Goto], [Disp All] or [Disp Route], and press the **ENT/CNTR** key.
 Disp Goto: Displays only the destination waypoint name.
 Disp All: Displays all waypoint names.
 Disp Route: Displays all waypoint names in the route when it is set as destination.
5. Press the **MENU** key twice to close the menu.

3.3 How to Edit Waypoints

Waypoint position, name, mark shape and comment can be edited on the plotter display or through the waypoint list.

Note: When the waypoint selected is set as the destination, the message "Change The Waypoint. Are you sure?" appears.

3.3.1 How to edit waypoints on the plotter display

1. Operate the cursorpad to place the cursor on the waypoint to edit.
2. Press the **ENT/CNTR** key to show the pop-up window.

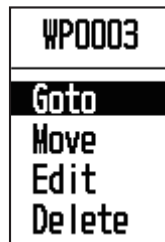

3. Select [Edit], and press the **ENT/CNTR** key to show the waypoint information.
4. Edit the waypoint (see the paragraph 3.1.3).
5. Press the **MENU** key to return to the plotter display.

3.3.2 How to edit waypoints through the list

1. Press the **MENU** key twice to show the main menu.
2. Select [Waypoints], and press the **ENT/CNTR** key.
3. Select [Alpha] or [Distance], and press the **ENT/CNTR** key.
Alpha: The list shows waypoints in alphabetical order.
Distance: The list shows waypoints from the nearest to the furthest.
4. Select the waypoint to edit, and press the **ENT/CNTR** key to show the pop-up window.



5. Select [Edit], and press the **ENT/CNTR** key to show the waypoint information.
6. Edit the waypoint data (see the paragraph 3.1.3).
7. Press the **MENU** key several times to close the menu.

3.4 How to Move Waypoints

You can move waypoints to any position on the plotter display.

1. Operate the cursorpad to place the cursor on the waypoint to move.
2. Press the **ENT/CNTR** key to show the pop-up window.

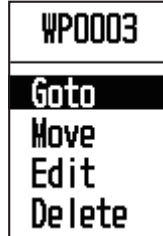

3. Select [Move], and press the **ENT/CNTR** key to show the waypoint information.
4. Operate the cursorpad to move the cursor to the new position.
5. Press the **ENT/CNTR** key.

3.5 How to Erase Waypoints

You can erase individual or all waypoint(s).

Note: You cannot individually erase the waypoint used as the current destination. (See paragraphs paragraph 3.5.1, paragraph 3.5.2.)

3.5.1 How to erase a waypoint on the plotter display

1. Operate the cursorpad to place the cursor on the waypoint to erase.
2. Press the **ENT/CNTR** key to show the pop-up window.

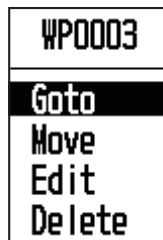

3. Select [Delete], and press the **ENT/CNTR** key.

3.5.2 How to erase a waypoint through the waypoint list

1. Press the **MENU** key twice to show the main menu.
2. Select [Waypoints], and press the **ENT/CNTR** key.
3. Select [Alpha] or [Distance], and press the **ENT/CNTR** key.
4. Select the waypoint to erase, and press the **ENT/CNTR** key.



5. Select [Delete], and press the **ENT/CNTR** key.
6. Press the **MENU** key several times to close the menu.

3.5.3 How to erase all waypoints

1. Press the **MENU** key twice to show the main menu.
2. Select [Delete], and press the **ENT/CNTR** key.

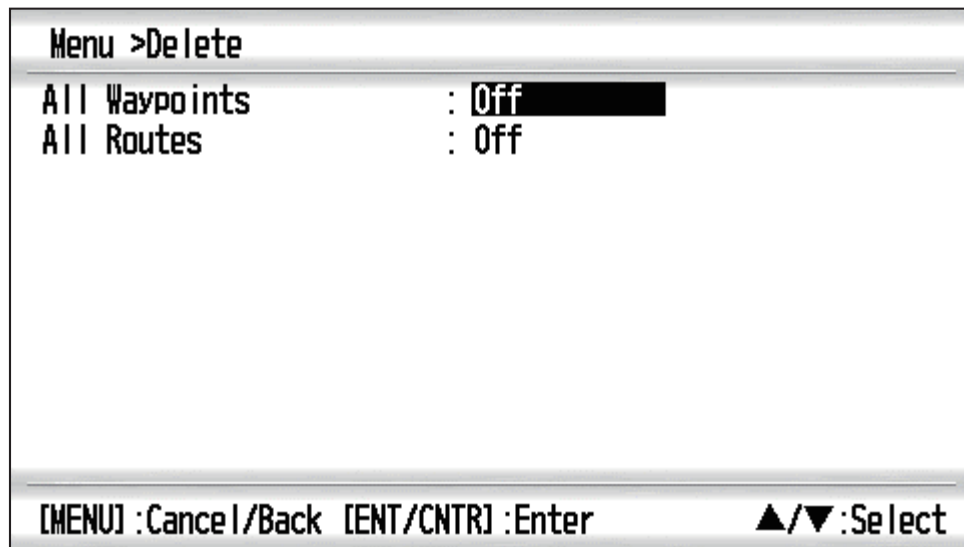

3. Confirm that [All Waypoints] is selected, and press the **ENT/CNTR** key.



4. Select [Delete], and press the **ENT/CNTR** key.

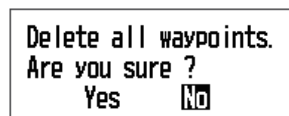

When no waypoint is set as destination

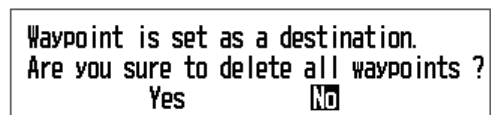

When a waypoint is set as destination

5. Select [Yes], and press the **ENT/CNTR** key to erase all waypoints.
Note: To cancel, select [No].
6. Press the **MENU** key twice to close the menu.

3. WAYPOINTS

This page is intentionally left blank.

4. ROUTES

In many cases a trip from one place to another involves several course changes, requiring a series of waypoints which you navigate to, one after another. The sequence of waypoints leading to the ultimate destination is called a route. Your unit can automatically advance to the next waypoint on a route, so you do not have to change the destination waypoint repeatedly.

4.1 How to Create Routes

You can store up to 100 routes, and a route can have 30 waypoints. A route is constructed with the waypoints you have entered.

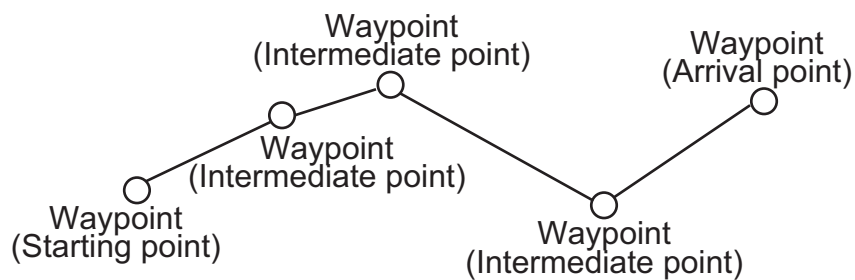

Sample route

1. Press the **MENU** key twice to show the main menu.
2. Select [Routes], and press the **ENT/CNTR** key.
3. Select [Alpha] or [Distance], and press the **ENT/CNTR** key.
4. Press the **ENT/CNTR** key to show the route list.

Menu >Routes >Route List		
Name	TLEG (NM)	Number
[New]		

[MENU] :Cancel/Back [ENT/CNTR] :Enter ▲/▼:Select

4. ROUTES

- Confirm that [New] is selected, and press the **ENT/CNTR** key to show the route information.

Routes >Route List >Route Info.					
Name	:	RT0001	Total LEG	0.00NM	0 Points
Cmnt	:	->	LEG		BRG
1	:	_____			
2	:	_____	___NM		___
3	:	_____	___NM		___
4	:	_____	___NM		___
5	:	_____	___NM		___
6	:	_____	___NM		___
7	:	_____	___NM		___
8	:	_____	___NM		___

[MENU] :Cancel/Back [ENT/CNTR] :Enter ▲/▼ :Select

- Press the **ENT/CNTR** key to change the route name.



- Operate the cursorpad to enter the route name, and press the **ENT/CNTR** key (maximum: six characters).
- Press ▼. Confirm that the cursor is at the right of [Cmnt], and **ENT/CNTR** key.

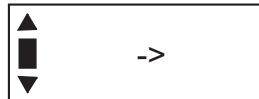

- Operate the cursorpad to enter the comment (maximum: 18 characters).
- Press ▼ to move the cursor to [1], and press the **ENT/CNTR** key.



- Confirm that [Add] is selected, and press the **ENT/CNTR** key.
- Select [Alpha] or [Distance], and press the **ENT/CNTR** key to show the waypoint list.
- Select the waypoint to add to the route, and press the **ENT/CNTR** key.
The selected waypoint (as the starting point) is registered to [1].
- Press ▼ to select [2], and press the **ENT/CNTR** key.
- Repeat steps 10 through 13 to complete the route.
- Press the **MENU** key several times to close the menu.

4.2 How to Edit Routes

You can edit the route created.

Note: When the route that is selected is set as route navigation, the message "Route is set as a destination. Are you sure?" appears.

4.2.1 How to replace a waypoint in a route

1. Press the **MENU** key twice to show the main menu.
2. Select [Routes], and press the **ENT/CNTR** key.
3. Select [Alpha] or [Distance], and press the **ENT/CNTR** key to show the route list.
4. Select the route to edit, and press the **ENT/CNTR** key.



5. Select [Edit], and press the **ENT/CNTR** key to show the route list.
6. Select the waypoint to replace, and press the **ENT/CNTR** key.

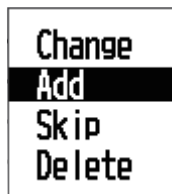

7. Select [Change], and press the **ENT/CNTR** key.
8. Select [Alpha] or [Distance], and press the **ENT/CNTR** key to show the waypoint list.
9. Select the new waypoint, and press the **ENT/CNTR** key.
10. Press the **MENU** key several times to close the menu.

4.2.2 How to delete a waypoint from a route

1. Press the **MENU** key twice to show the main menu.
2. Select [Routes], and press the **ENT/CNTR** key.
3. Select [Alpha] or [Distance], and press the **ENT/CNTR** key to show the route list.
4. Select the route to edit, and press the **ENT/CNTR** key.
5. Select [Edit], and press the **ENT/CNTR** key to show the route information.
6. Select the waypoint to delete from the route, and press the **ENT/CNTR** key.
7. Select [Delete], and press the **ENT/CNTR** key.
8. Press the **MENU** key several times to close the menu.

4.2.3 How to insert a waypoint in a route

To insert a waypoint in a route, do the following:

1. Press the **MENU** key twice to show the main menu.
2. Select [Routes], and press the **ENT/CNTR** key.
3. Select [Alpha] or [Distance], and press the **ENT/CNTR** key to show the route list.
4. Select the route to edit, and press the **ENT/CNTR** key.
5. Select [Edit], and press the **ENT/CNTR** key to show the route list.
6. Select the waypoint which will come after the waypoint to be inserted, and press the **ENT/CNTR** key.
7. Select [Add], and press the **ENT/CNTR** key.
8. Select [Alpha] or [Distance], and press the **ENT/CNTR** key to show the waypoint list.
9. Select the waypoint, and press the **ENT/CNTR** key.
10. Press the **MENU** key several times to close the menu.

4.2.4 How to temporarily deselect a waypoint in a route

You can temporarily deselect an unnecessary waypoint from a route. Using the route created in the illustration shown below as an example, deselect the second intermediate waypoint.

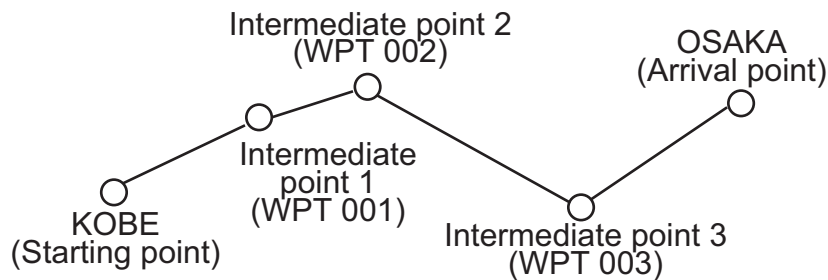

If you reconstruct the route without the second intermediate point it would look like the illustration below.

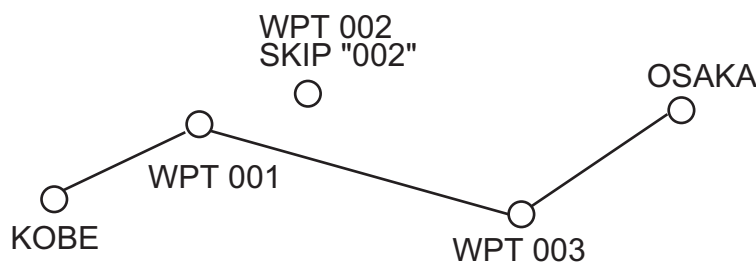

1. Press the **MENU** key twice to show the main menu.
2. Select [Routes], and press the **ENT/CNTR** key.
3. Select [Alpha] or [Distance], and press the **ENT/CNTR** key to select the route list.
4. Select the route to edit, and press the **ENT/CNTR** key.
5. Select [Edit], and press the **ENT/CNTR** key to show the route information.
6. Select the waypoint to skip, and press the **ENT/CNTR** key.

7. Select [Skip], and press the **ENT/CNTR** key to show “X” next to the waypoint selected at step 6.
8. Press the **MENU** key several times to close the menu.

Note: To restore a waypoint to a route, select [Skip Off] at step 7, and press the **ENT/CNTR** key.

4.3 How to Erase a Route

You can erase routes individually or collectively.

4.3.1 How to erase a route through the route list

Note: The route used as route navigation can not be erased.

1. Press the **MENU** key twice to show the main menu.
2. Select [Routes], and press the **ENT/CNTR** key.
3. Select [Alpha] or [Distance], and press the **ENT/CNTR** key to show the route list.
4. Select the route to erase, and press the **ENT/CNTR** key.
5. Select [Delete], and press the **ENT/CNTR** key to erase the route selected at step 4.
6. Press the **MENU** key several times to close the menu.

4.3.2 How to erase all routes

1. Press the **MENU** key twice to show the main menu.
2. Select [Delete], and press the **ENT/CNTR** key.
3. Select [All Routes], and press the **ENT/CNTR** key.
4. Select [Delete], and press the **ENT/CNTR** key to show the following message.

Delete all routes.
Are you sure?
Yes **No**

When no route is set as destination

Route is set as destination.
Are you sure to delete all routes?
Yes **No**

When a route is set as destination

5. Select [Yes], and press the **ENT/CNTR** key to erase all routes.
Note: To cancel, select [No].
6. Press the **MENU** key twice to close the menu.

4. ROUTES

This page is intentionally left blank.

5. DESTINATION

Destination can be set four ways: by cursor, by waypoint, by route and by MOB position. The previous destination is cancelled whenever a new destination is set. How to set a MOB position is described in section 1.6. When setting a destination, a blue line is shown between own ship and the destination selected. Also, the range and bearing from own ship to the destination are shown at the left-hand side of the screen.

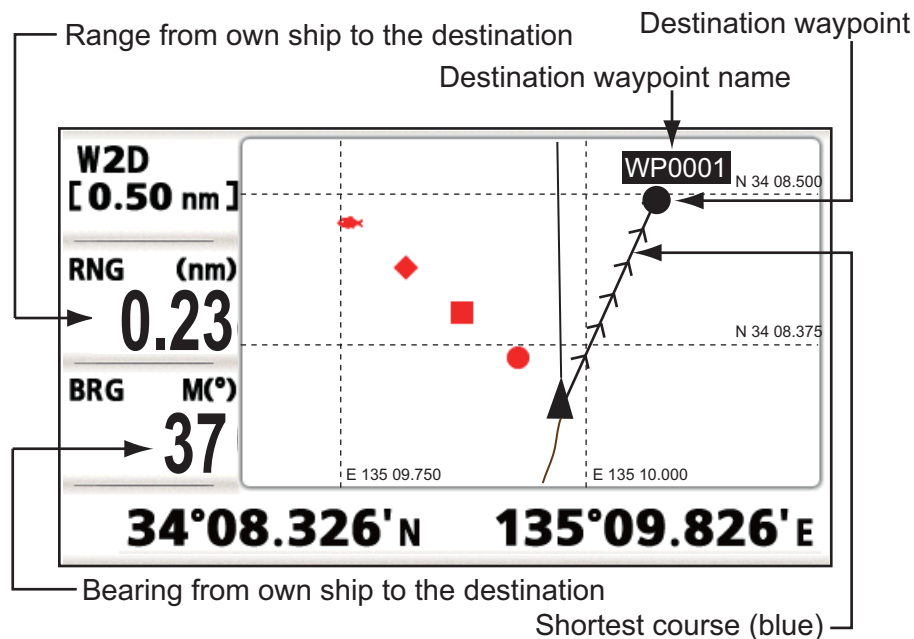

5.1 How to Set Destination by Cursor Position

You can quickly set a destination called "Quick Point", i.e. "QP".

1. On the plotter display, operate the cursorpad to place the cursor on the location desired for destination.
2. Press the **GO TO** key to enter the quick point.
The quick point is shown with a green solid circle, and named as "QP". This point is saved in the waypoint list automatically.
3. Cancel the destination, referring to section 5.4, when you arrive at the waypoint.

Note: Each quick point set is erased when a new one is entered.

5.2 How to Set Destination by Waypoint

You can set a waypoint as a destination by using the cursor or the waypoints list.

5.2.1 How to set a destination waypoint with the cursor

1. On the plotter display, operate the cursorpad to place the cursor on the waypoint which you want to set as the destination.
2. Press the **ENT/CNTR** key.

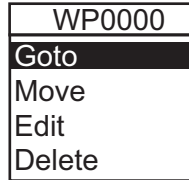

3. Select [Goto], and press the **ENT/CNTR** key.
4. Cancel the destination, referring to section 5.4, when you arrive at the waypoint.

5.2.2 How to set a destination waypoint from the list

1. Press the **MENU** key twice to show the main menu.
2. Select [Waypoints], and press the **ENT/CNTR** key.
3. Select [Alpha] or [Distance], and press the **ENT/CNTR** key to show the waypoint list.

Menu >Waypoints >Waypoint List				
Name	Symbol	Color	RNG (NM)	BRG (°)
[New]				
G WP0001	●	Red	1.11	167
WP0002	■	Red	0.83	171
WP0003	◆	Red	0.70	175
WP0004	⦿	Red	0.64	177
WP0005	⦿	Red	0.60	178

[MENU] :Cancel/Back [ENT/CNTR] :Enter ▲/▼ :Select

4. Select the waypoint to set as a destination, and press the **ENT/CNTR** key.



5. Select [Goto], and press the **ENT/CNTR** key to show the plotter display.
6. Cancel the destination, referring to section 5.4, when you arrive at the waypoint.

5.3 How to Set Route as Destination

You can set a route as destination through the list.

1. Press the **MENU** key twice to show the main menu.
2. Select [Routes], and press the **ENT/CNTR** key.
3. Select [Alpha] or [Distance], and press the **ENT/CNTR** key.

Menu >Routes >Route List				
Name		TLEG (NM)	Number	
[New]				
RT0000	: WP0000 ->WP0001	0. 14	2	
RT0001	: WP0003 ->WP0001	0. 23	2	
RT0002	: WP0001 ->WP0002	0. 30	3	
RT0003	: WP0001 ->WP0003	0. 23	2	

[MENU] :Cancel/Back [ENT/CNTR] :Enter ▲/▼:Select

4. Select the route to set as a destination, and press the **ENT/CNTR** key.

Goto
Edit
Delete

5. Select [Goto], and press the **ENT/CNTR** key.
6. Select [Forward] or [Reverse].
 Forward: Follows waypoints in order registered (1→2→3...)
 Reverse: Follows waypoints in reverse order registered (30 (when maximum entered) →29→28...→1)
7. Press the **ENT/CNTR** key to show the plotter display. The destination route is shown with waypoints connected with legs.
8. Cancel the destination referring to section 5.4 when arriving at the waypoint.

How to change the route direction after a destination is set

After a route is started, you can change the direction of the route from [Forward] to [Reverse], or vice versa. Place the cursor on a leg of the route, and press the **ENT/CNTR** key to show the following pop-up window. Select [Reverse] (or [Forward]). Then, select [Yes] and press the **ENT/CNTR** key.

RT0000
Cancel Route
Reverse
Route Info.

Note: If your boat has not yet arrived at the first waypoint in the route, the current route destination is cancelled when you select [Reverse] (or [Forward]). Set the route destination again.

5.4 How to Cancel a Destination

You can cancel a destination by using the cursor, or through the list.

5.4.1 How to cancel a destination with the cursor

1. On the plotter display, operate the cursorpad to place the cursor on the waypoint (route) set as the current destination.
2. Press the **ENT/CNTR** key.

WP0001
Move
Cancel Goto
Edit
Delete

QP0001
Move
Cancel Goto
Edit
Delete

WP0001
Move
Skip
Cancel Route
Edit

RT0000
Cancel Route
Reverse
Route Info.

(for waypoint destination) (for QP destination) (for route navigation)

(for route leg)

3. Select [Cancel Goto (Route)], and press the **ENT/CNTR** key.

Cancel Goto. Are you sure?
Yes No

Cancel Route Navigation. Are you sure?
Yes No

(for waypoint destination)

(for route navigation)

4. Chose [Yes], and press the **ENT/CNTR** key.
To cancel, select [No].

5.4.2 How to cancel a destination through the list

1. Press the **MENU** key twice to show the main menu.
2. Select [Waypoints] (or [Routes]), and press the **ENT/CNTR** key twice.
3. Select the waypoint (route) set as the current destination.

Menu >Waypoints >Waypoint List					
Name	Symbol	Color	RNG (nm)	BRG (°)	
[New]					
G WP0001	●	Red	115	115	Destination mark
WP0002	■	Red	116	116	
WP0003	◆	Red	117	117	
R WP0004	⦿	Red	118	118	Waypoint used for destination route
WP0005	⦿	Red	119	119	
[MENU] :Cancel/Back [ENT/CNTR] :Enter ▲/▼:Select					

4. Press the **ENT/CNTR** key.

Cancel Goto
Edit
Delete

Cancel Route
Edit
Delete

(for waypoint destination) (for route navigation)

5. Select [Cancel Goto (Route)], and press the **ENT/CNTR** key.

Cancel Goto.
Are you sure?
Yes **No**

(for waypoint destination)

Cancel Route Navigation.
Are you sure?
Yes **No**

(for route navigation)

6. Select [Yes], and press the **ENT/CNTR** key.
To cancel, select [No].
7. Press the **MENU** key several times to close the menu.

5.5 How to Set a Destination from Other Displays

You can select a destination from displays other than the plotter display by pressing **GO TO** key.

Press **GO TO** key when using a display other than plotter to show the [Goto] menu.

```
Goto
Waypoints-Alpha
Waypoints-Distance
Routes-Alpha
Routes-Distance
QP
```

```
[MENU] :Cancel/Back [ENT/CNTR] :Enter ▲/▼ :Select
```

- [Waypoints-Alpha]: Waypoint list in alphabetical order
- [Waypoints-Distance]: Waypoint list showing waypoints near from current position.
- [Routes-Alpha]: Route list in alphabetical order.
- [Routes-Distance]: Route list showing routes in distance order.
- [QP]: Moves to plotter display to enter QP.

5. DESTINATION

This page is intentionally left blank.

6. ALARMS

6.1 Overview

There are eight alarm conditions which generate both audio and visual alarms: Arrival alarm, Anchor watch alarm, XTE (Cross-Track Error) alarm, Speed alarm, WAAS alarm, Time alarm, Trip alarm and Odometer alarm.

When an alarm setting is violated, the buzzer sounds and the name of the offending alarm and the alarm icon appear on the display (alarms other than Speed Based Output).

You can silence the buzzer and remove the alarm indication by pressing any key. The alarm icon remains on the screen until the reason for the alarm is cleared.

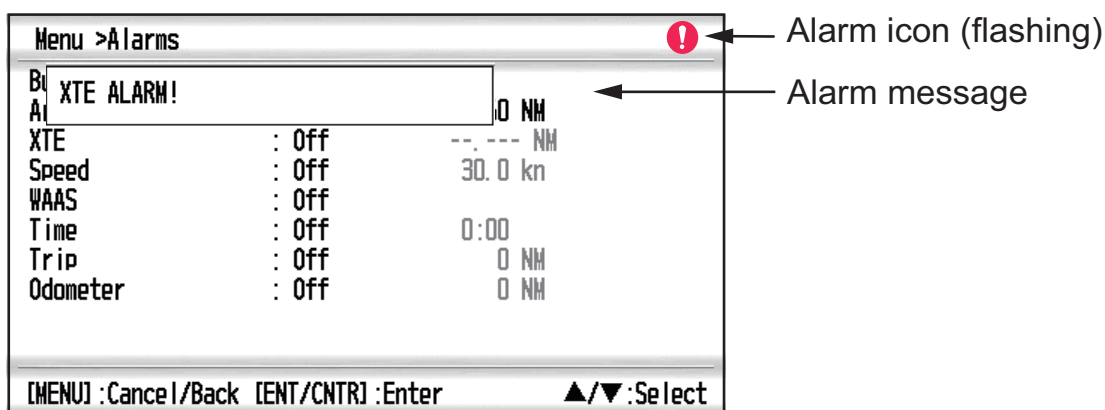

To know which alarm has been violated, do the following procedure.

1. Press the **MENU** key twice to show the main menu.
2. Select [Messages], and press the **ENT/CNTR** key.

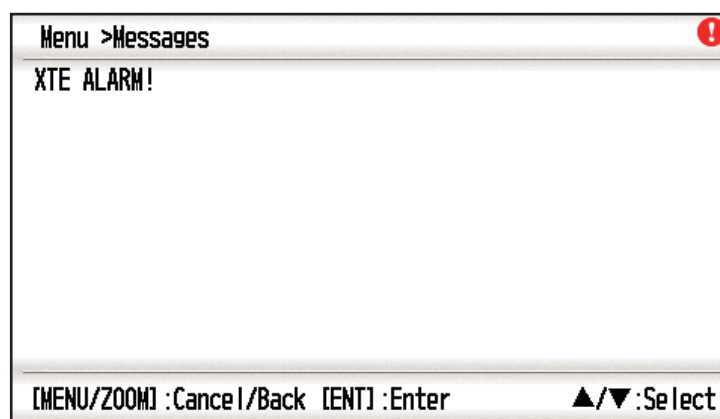

Example alarm message

The display shows the names of offending alarms. When there are no alarms, the message "No Message!" appears.

Message and meanings

Message	Meaning
XTE ALARM!	The boat is off its intended course by the range set.
TIME ALARM!	The time set has come.
SPEED ALARM!	The boat's speed is higher than the range set.
ARRIVAL ALARM!	The boat is approaching the arrival area.
TRIP ALARM!	The boat has traveled further than the preset trip distance.
ODOMETER ALARM!	The boat has traveled the total distance set.
ANCHOR WATCH!	The boat has moved a certain distance (when it should be at rest).
NO WAAS SIGNAL!	WAAS signal cannot be found.

Note: The message screen also shows equipment trouble. See section 8.3.

6.2 Buzzer Type Selection

The buzzer sounds whenever an alarm setting is violated. You can select the type of buzzer as follows:

1. Press the **MENU** key twice to show the main menu.
2. Select [Alarms], and press the **ENT/CNTR** key.
3. Select [Buzzer], and press the **ENT/CNTR** key.

Short
Long
Cont inuous

4. Select buzzer type, and press the **ENT/CNTR** key.
 Short: Unit emits a short beep sound for 1 second and off for 1 second.
 Long: Unit emits a long beep sound for approximately 3 seconds for three times.
 Continuous: Unit continuously emits long beep sounds until a key is pressed.
5. Press the **MENU** key twice to close the menu.

6.3 How to Set an Alarm

Set alarms as below:

Note: For the Anchor alarm, press the **MARK/MOB** key to enter the waypoint at own ship's position, and set it as a destination referring to paragraph 5.2.1.

1. Press the **MENU** key twice to show the main menu.
2. Select [Alarms], and press the **ENT/CNTR** key.

Menu >Alarms			
Buzzer	:	Long	
Arrival/Anchor	:	Off	0.50 NM
XTE	:	Off	--, --- NM
Speed	:	Off	30.0 kn
WAAS	:	Off	
Time	:	Off	0:00
Trip	:	Off	0 NM
Odometer	:	Off	0 NM
[MENU] :Cancel/Back [ENT/CNTR] :Enter ▲/▼:Select			

3. Select an alarm item, and press the **ENT/CNTR** key.
4. Do one of the following:
 - (Arrival/Anchor)
 - 1) Select [Arrival] or [Anchor], and press the **ENT/CNTR** key.
 - 2) Press ► and **ENT/CNTR** key.
 - 3) Enter the alarm area, and press the **ENT/CNTR** key.
 - (XTE, Speed, Trip and Odometer)
 - 1) Select [On], and press the **ENT/CNTR** key.
 - 2) Press ► and **ENT/CNTR** key.
 - 3) Enter the value, and press the **ENT/CNTR** key.
 - (WAAS)

Select [On], and press the **ENT/CNTR** key.
 - (Time)
 - 1) Select [On], and press the **ENT/CNTR** key.
 - 2) Press ► and **ENT/CNTR** key in order.
 - 3) Enter the time, and press the **ENT/CNTR** key.
 - 4) For 12-hour clock, press ► and **ENT/CNTR** key.
 - 5) Select [AM] or [PM], and press the **ENT/CNTR** key.
5. Press the **MENU** key twice to close the menu.

Note 1: To cancel an alarm, select [Off] at 1) on step 4.

Note 2: You can activate either the arrival alarm or the anchor watch alarm; they cannot be activated together.

6.4 Alarm Descriptions

Arrival alarm

The arrival alarm informs you that own ship is approaching a destination waypoint. The "arrival zone" is circle-shaped and the alarm setting is the radius of the circle. The alarm activates if your boat enters the circle.

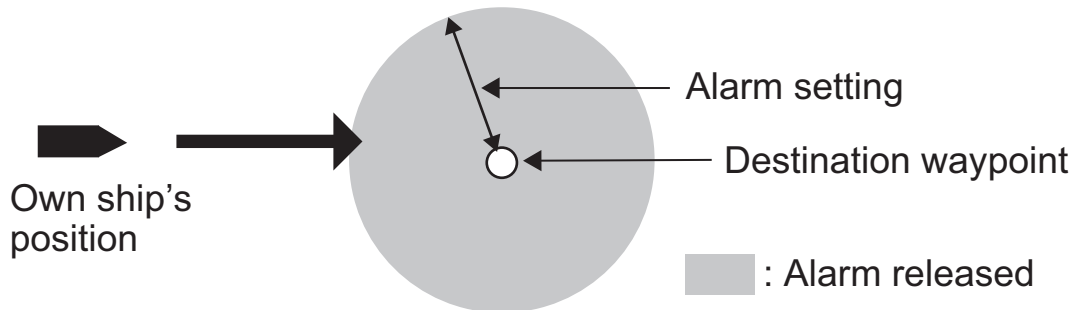

How the arrival alarm works

Anchor watch alarm

The anchor watch alarm sounds to warn you that your boat is moving when it should be at rest. Before setting the anchor watch alarm, set current position as destination waypoint.

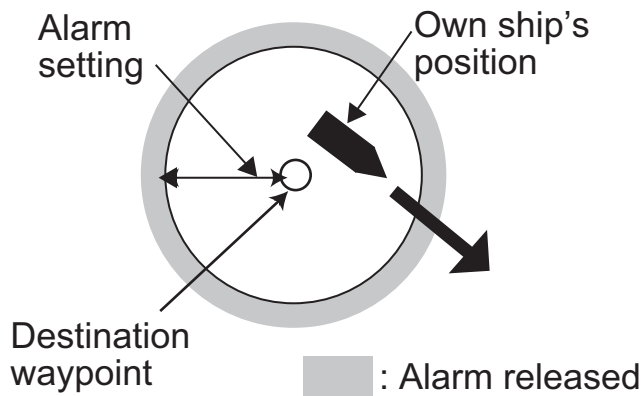

How the anchor watch alarm works

XTE (Cross-Track Error) alarm

The XTE alarm warns you when own ship is not on its intended course.

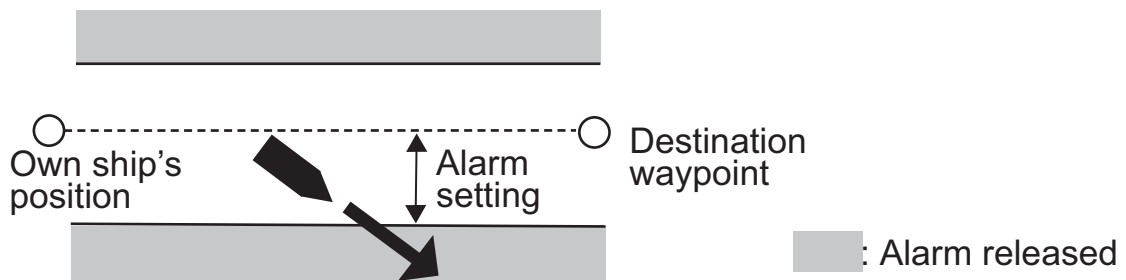

How the XTE alarm works

Speed alarm

The speed alarm alerts you when the boat's speed is higher than the alarm range set.

WAAS alarm

This alarm alerts you when the WAAS signal is lost (for all status indications except W2D/W3D). Note that [On] cannot be selected if [Mode] in [WAAS] menu is set to [GPS].

Time alarm

The time alarm works like an alarm clock, releasing audio and visual alarms when the time entered has come.

Trip alarm

The trip alarm tells you when your boat has traveled further than the preset trip distance.

Odometer alarm

This alarm alerts you when your boat has traveled the total distance you set.

6. ALARMS

This page is intentionally left blank.

7. OTHER FUNCTIONS

This chapter describes menu items not covered in other chapters.

7.1 Plotter Setup Menu

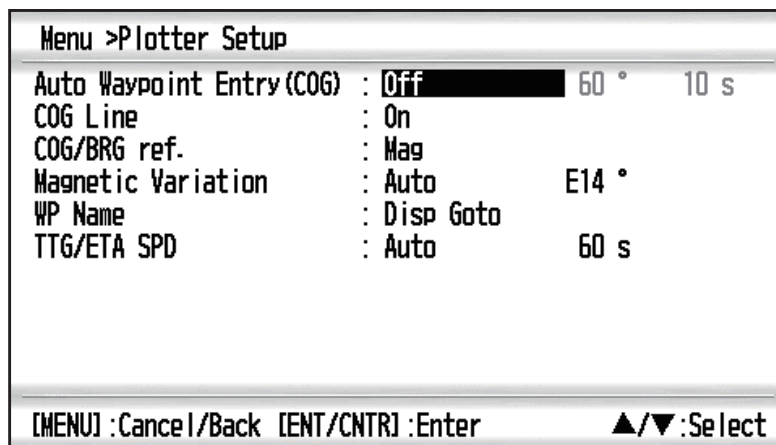

COG Line

You can show or hide the COG line on the plotter display.

COG/BRG ref.

Boat's course and bearing to a waypoint are displayed in true or magnetic bearing. Magnetic bearing is true bearing plus (or minus) earth's magnetic variation. Select the bearing reference according to the installed compass: magnetic for magnetic compass, true for gyrocompass or satellite compass using true bearing.

Magnetic Variation

The location of the magnetic north pole is different from the geographical north pole. This causes a difference between the true and magnetic north direction. The difference is called magnetic variation, and varies with respect to the observation point on earth. Your unit is pre-programmed with all the earth's magnetic variation. However, you may wish to enter variation manually to refine accuracy using the latest chart. Set [COG/BRG ref.] on the Plotter Setup menu to [Mag] to use magnetic variation.

To enter magnetic variation manually, do the following:

- 1) If necessary, change coordinate from east to west or vice versa.
- 2) Enter the value referring to a recent nautical chart.
- 3) Press the **ENT/CNTR** key.

TTG/ETA SPD

To calculate time to go and estimated time of arrival, enter your speed as below.

- Auto (GPS calculated speed)

1. Press ► and **ENT/CNTR** in order.
2. Enter the speed average (1 to 999 sec.) to use, and press the **ENT/CNTR** key.

7. OTHER FUNCTIONS

- Manual (Speed calculated manually)

1. Press ► and **ENT/CNTR** in order.
2. Enter speed (1 to 999 knot), and press the **ENT/CNTR** key.

7.2 Delete Menu

You can delete all waypoints and routes listed in [Waypoint List] and [Route List].

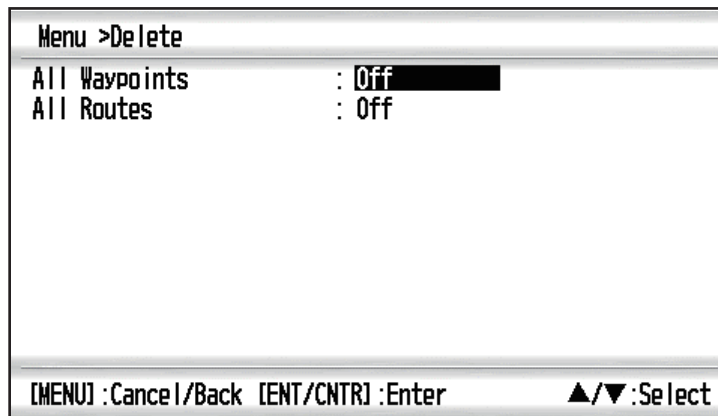

7.3 GPS Setup Menu

The GPS Setup menu smooths position and course, averages speed, applies position offset, and deactivates unhealthy satellites.

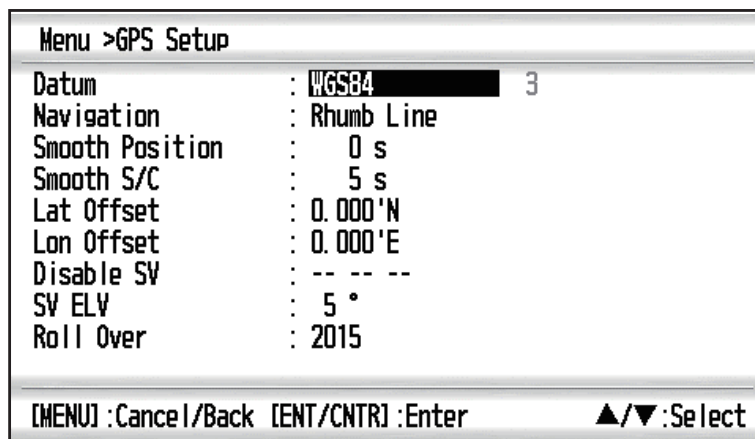

Datum

Your unit is programmed to recognize most of the major chart systems of the world. Although the WGS-84 system, the GPS standard, is now widely used other categories of charts still exist. Select the same datum which is used in your nautical charts. Select WGS84 (default setting), WGS72 or Other (Datum entry required).

Navigation

When you set a destination, the equipment displays the range, bearing and course to that destination. Range and bearing are calculated by the Great Circle or Rhumb Line method. Route total distance is also calculated. Cross-track error is only calculated in the Rhumb Line method.

Rhumb line: This method calculates the range and bearing between two points drawn on a nautical chart. Since the bearing is kept constant it is ideal for short-range navigation.

Great circle: This course line is the shortest course between two points on the surface of the earth, like stretching a piece of string between two points on earth. Frequent bearing changes are required to navigate by this method. For long-range navigation, divide the Great Circle route into several routes, and navigate each route by Rhumb Line.

Smooth Position

When the receiving condition is unfavorable, the GPS fix may change randomly, even if the boat is at a stop in water. This change can be reduced by smoothing the raw GPS fixes. The setting range is from 0 (no smoothing) to 999 seconds. The higher the setting the more smoothed the raw data, however too high a setting slows response time. This is especially noticeable at high boat speeds. "0" is the normal setting; increase the setting if the GPS fix changes randomly.

Smooth S/C (speed/course)

During position fixing, your boat's velocity (and course) is directly measured by receiving GPS satellite signals. The raw velocity data may change randomly depending on receiving conditions and other factors. You can reduce this random variation by increasing the smoothing. Similar to latitude and longitude smoothing, the higher the speed and course smoothing the more smoothed the raw data. If the setting is too high, however, the response to speed and course change slows. The setting range is from 0 (no smoothing) to 9999 seconds.

Lat Offset, Lon Offset

If there is the error between the positions shown on your equipment and chart when docking at a pier, you can apply an offset to latitude and longitude position. Mark the own ship's position on the chart to calculate the error with latitude and longitude, then enter the values.

Disable SV (satellite)

Every GPS satellite is broadcasting abnormal satellite number(s) in its Almanac, which contains general orbital data about all GPS satellites. Using this information, the GPS receiver automatically eliminates any malfunctioning satellite from the GPS satellite schedule. However, the Almanac sometimes may not contain all of the available information. You can disable an inoperative satellite manually. Enter satellite numbers (max. three satellites) in two digits.

SV ELV (satellite elevation)

Set the minimum elevation of satellites to use to fix position.

Roll Over

Set the year when the roll over occur. The GP-39 will automatically turns off and on to reset the satellite observation.

7.4 WAAS Menu

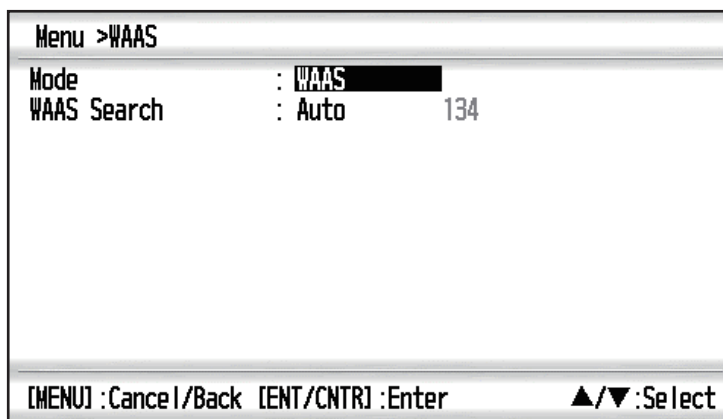

*Use "0" (as default setting).

Mode

You can select [WAAS] or [GPS] for the position fixing mode. In both mode, [WAAS Search] has [Auto] or [Manual] as [WAAS Search] mode. When selecting [Auto], the mode automatically select the satellite. When selecting [Manual], you can manually select the satellite number.

WAAS Search

For WAAS setting, the GEO satellite is searched automatically or manually.
For GEO satellite number, see page AP-3.

Auto: The system automatically searches for the optimum GEO satellite from your current position. (All satellites are searched.)

Manual: Enter a GEO satellite number manually.

Correction Data Set

Use [0] as default setting.

7.5 Position Display Format

Position can be shown in latitude and longitude or TDs (Loran C). Loran C chain data is programmed into the equipment.

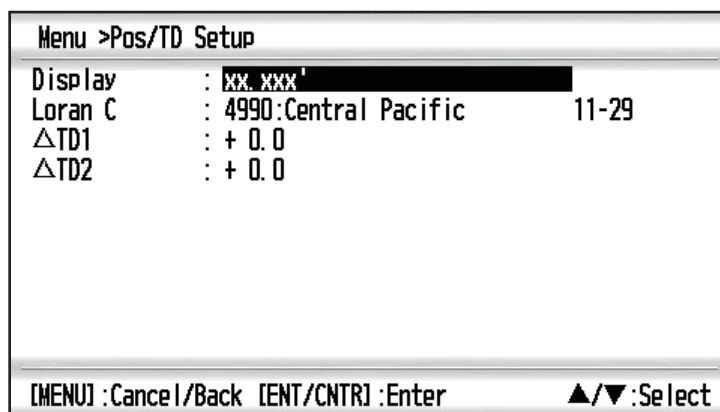

Display

Select the position format.

- xx.xxx': Shows L/L position with no seconds.
- xx'xx.x": Displays L/L position with seconds.
- LC TD: Loran C TDs

Loran C

When choosing LC TD at Display, do the following:

- 1) Press the **ENT/CNTR** key.
- 2) Select the GRI code, and press the **ENT/CNTR** key.
- 3) Press **▶** and **ENT/CNTR** key.
- 4) Select the pair of slave station, and press the **ENT/CNTR** key.

△TD1, △TD2

Enter TD offsets to refine Loran C position accuracy.

7.6 System Menu

In the System menu, you can customize various display settings, for example, time and date formats, etc.

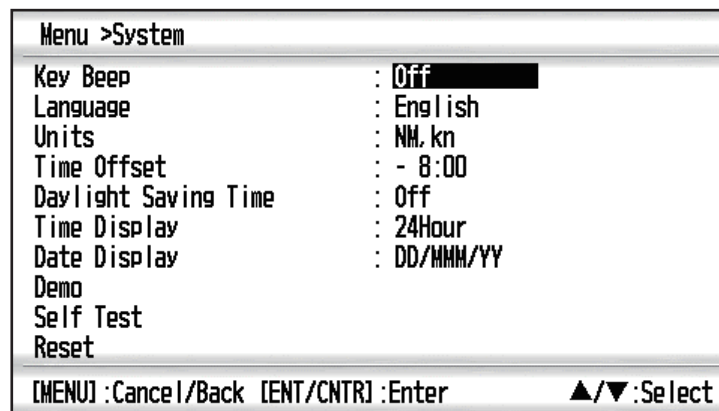

Key Beep

This item turns the key beep on or off.

Units

The Units item lets you select the unit of measurement for range, speed and distance, from the units shown below.

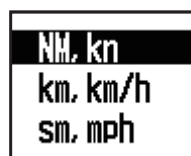

7. OTHER FUNCTIONS

Time Offset

GPS uses UTC time. If you would rather use local time, enter the time difference (range: -14:00 to +14:00, 15 minutes step) between it and UTC time.

Daylight Saving Time

For countries that use daylight savings time, select On to enable daylight savings time.

Time Display

You can display the time in 12 or 24 hour format.

Date Display

Select the date display, DD/MM/YY or MM/DD/YY.

Demo

The demonstration display provides simulated operation of this unit. You may set the speed manually and course manually or automatically. All controls are operative - you may enter marks, set destination, etc.

- **Mode:** Select [On]. The indication SIM appears at the top left-hand side to inform you that the simulation mode is in use. To cancel, select [Off].
- **Speed:** Enter the speed (two digits) to use for the demonstration mode.
- **Course:** Select Auto or Manual. For manual entry of course, enter course in three digits. The Auto course tracks a circular course.
- **Lat, Lon:** Enter latitude and longitude of the position to start the demonstration.

Reset (Trip)

You can reset the trip meter to zero. Select [On] at [Trip] on System>Reset menu.

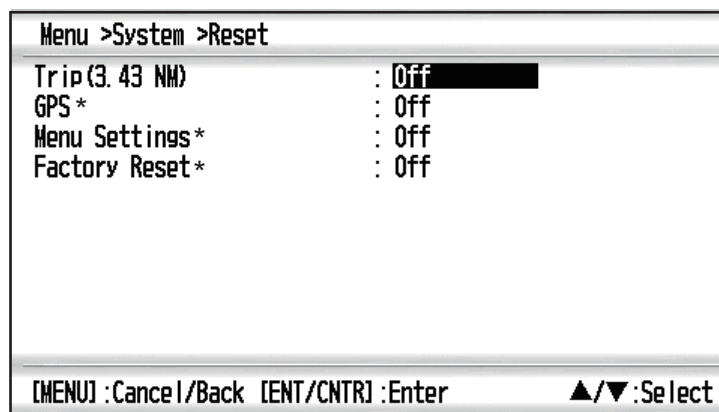

*: Items to be cleared (See section 8.5.)

7.7 User Display Menu

To customize user displays, which are [6] and [7] appeared when the **DISP** key is pressed (see section 1.4), use the User Display menu.

	DISP key is pressed	Item name on User Display menu
User display 1	Display [6]	Display 1
User display 2	Display [7]	Display 2

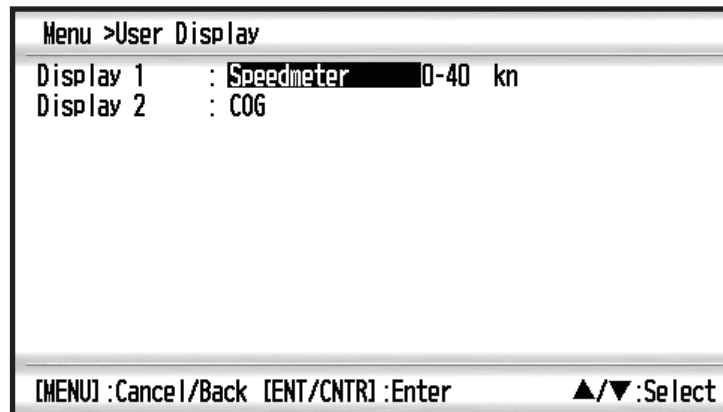

Note: You can show the User Display menu by pressing the **ENT/CNTR** key more than three seconds at the User display 1 (display [6]) and 2 ([7]).

Display 1, Display 2

You can select items to show on the User display 1 (display [6]) and 2 ([7]), from among digital data, speedometer and COG (see page 1-7). When choosing [Off] for Display 2, for example, the display [7] is not shown.

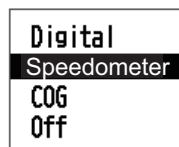

For [Digital], you can display one to four items of digital navigation data on the user display.

1. Press ► and **ENT/CNTR** key in order to show the following window.



7. OTHER FUNCTIONS

2. Select the screen division, which is the number of data to display, and press the **ENT/CNTR** key.
The display now looks something like the one shown below, showing data choices and screen division selected.

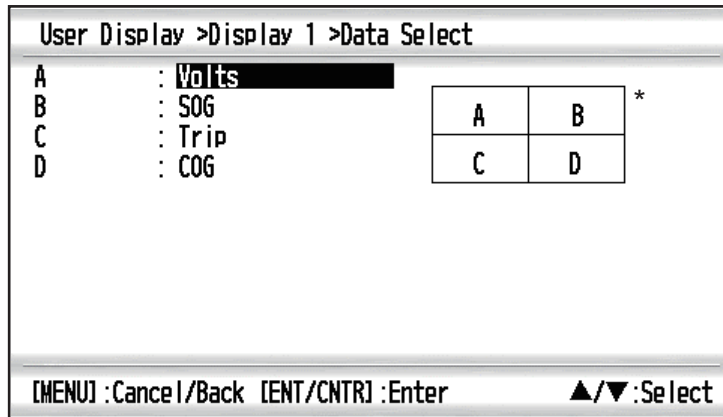

*: Depending on the selection at step 2.

A
B

A	B
C	D

A	B	C
---	---	---

3. Select [A], [B], [C] or [D], and press the **ENT/CNTR** key.

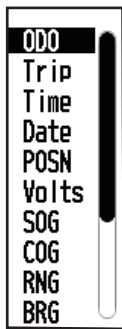

Page 1

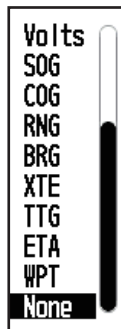

Page 2

ODO: Odometer distance
 Trip: Trip distance
 Time: Time
 Date: Date
 POSN: Position
 Volts: Power voltage
 SOG: Speed over ground
 COG: Course over ground
 RNG: Range
 BRG: Bearing
 XTE: Cross-track error
 TTG: Time to go (to destination)
 ETA: Estimated time to arrival (to destination)
 WPT: Range and bearing to waypoint
 None: No display

4. Select data desired, and press the **ENT/CNTR** key.
5. Repeat steps 3 and 4 to set other data.

You can select digital data also from the User display 1 (display [6]) and 2 ([7]) directly.

1. Press the **DISP** key several times to show User display 1 or 2 desired, and press the **ENT/CNTR** key to show the cursor.

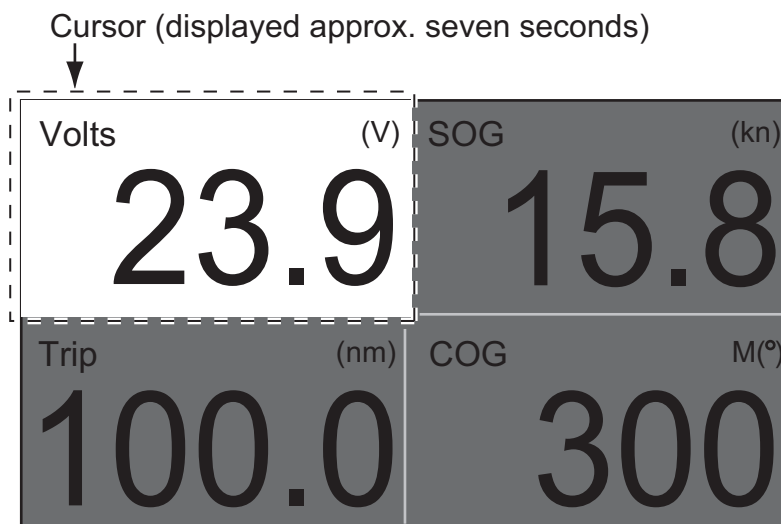

- Operate the cursorpad to select the column to select data, and press the **ENT/CNTR** key.



Page 1

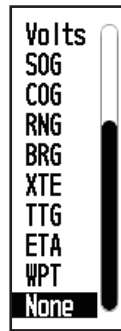

Page 2

ODO: Odometer distance
 Trip: Trip distance
 Time: Time
 Date: Date
 POSN: Position
 Volts: Power voltage
 SOG: Speed over ground
 COG: Course over ground
 RNG: Range
 BRG: Bearing
 XTE: Cross-track error
 TTG: Time to go
 (to destination)
 ETA: Estimated time to
 arrival (to destination)
 WPT: Range and bearing
 to waypoint
 None: No display

- Select the item to show, and press the **ENT/CNTR** key.
- Repeat steps 2 and 3 for other displays if necessary.

Speedometer

When choosing [speedometer], you can select the range for the speedometer to show on the User display 1 or 2.

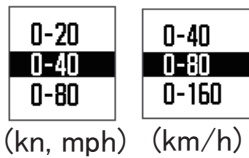

7.8 I/O Setup Menu

Waypoint and route data can be uploaded or downloaded between a USB flash memory and your unit.

There are two kinds of data for route data: route data and route comment data.

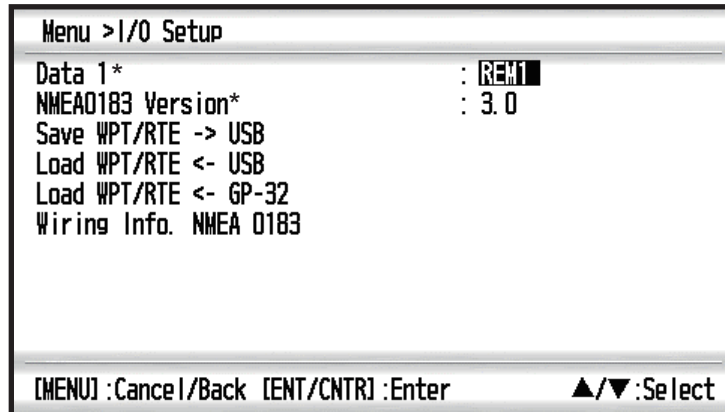

*: See chapter 9.

Note: No position fix is available during uploading or downloading.

Waypoint data format

\$PFEC,	GPwpl,	llll.ll,	a,	yyyyy.yy,	a,	c—c,	c,	c—c,	a,	hhmmss,	xx,	xx,	xxxx	<CR><LF>
		1	2	3	4	5	6	7	8	9	10	11	12	

1: Waypoint latitude

2: N/S

3: Waypoint longitude

4: E/W

5: Waypoint name (1 to 8 characters)

6: Waypoint color

(NULL/0: black, 1: red, 2: yellow, 3: green, 4: brown, 5: purple, 6: blue)

7: Waypoint mark and waypoint comment ("@_" (see below.)) + 0 to 13 characters)

-Following characters can be used for comments:

_ABCDEFGHIJKLMNQRSTUvwxyz0123456789&()+/=/?> (space)

-Following marks are waypoint marks:

●: @q, ■: @r, ◆: @s, 🐟: @t, 🚤: @u,

⚓: @v, 🏠: @w, ⚓: @x, 🗿: @y, 🏠: @z

8: Flag marking waypoint (A: displayed, V: Not displayed)

9: UTC (Always NULL)

10: Day (Always NULL)

11: Month (Always NULL)

12: Year (Always NULL)

Route data format

$\$GPRTE, \frac{x.x}{1}, \frac{x.x}{2}, \frac{a}{3}, \frac{c--c}{4}, \frac{c--c}{5}, \dots, \frac{c--c}{12} <CR><LF>$

- 1: Number of sentences required for one complete route data (1 to 6) See note.
- 2: Number of sentences currently used (1 to 6)
- 3: Message mode (Always set to "C".)
- 4: Route No. (1 to 100)
- 5 to 12: Waypoint name (1 to 8 characters, length of each waypoint name is fixed to 7 byte)
 - 1st byte: "-" (hyphen)= skip ON, " " (space)= skip OFF
 - After 2nd byte: Waypoint name (1 to 8 characters)

Note: A route can contain max.30 waypoints and GPRTE sentence for one route data may exceed 80 byte limitation. In this case, route data is divided into several GPRTE sentences (max. 4 sentences). This value shows the number of sentences route data has been divided.

Route comment data format

$\$PFEC, GPrtc, \frac{x}{1}, \frac{c--c}{2}, \frac{c--c}{3} <CR><LF>$

- 1: Route No. (1 to 100)
- 2: Route comment (Max. 18 characters, variable length)
- 3: Route name (Max. 6 characters, variable length)

End of sentence

$\$PFEC, GPxfr, CTL, E <CR><LF>$

7.8.1 Uploading data to a USB flash memory

Note: Do not remove the USB flash memory during data upload.

1. Connect a USB flash memory to your GP-39, referring to the interconnection diagram at the back of this manual.
2. Press the **MENU** key twice to show the main menu.
3. Select [I/O Setup], and press the **ENT/CNTR** key.
4. Select [Save WPT/RTE -> USB], and press the **ENT/CNTR** key.

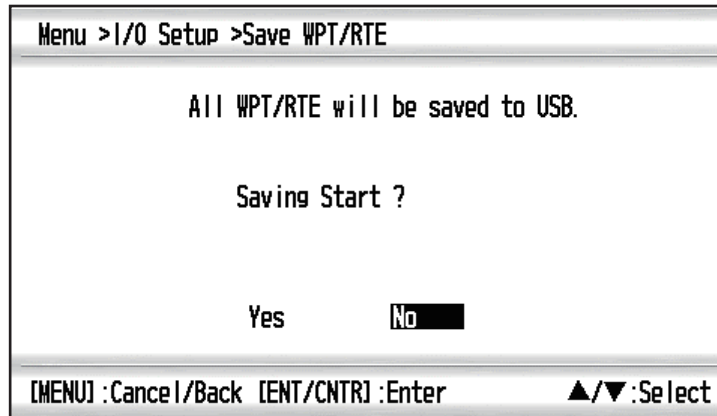

5. Press ◀ to select [Yes], and press the **ENT/CNTR** key to start the uploading.
6. When the completion message appears, press any key to finish.

7.8.2 Downloading data from a USB flash memory

Note 1: All waypoint and route data stored in the GP-39 will be deleted when data is downloaded from USB flash memory.

Note 2: Do not remove the USB flash memory during data download.

1. Connect a USB flash memory to your GP-39, referring to the interconnection diagram at the back of this manual.
2. Press the **MENU** key twice to show the main menu.
3. Select [I/O Setup], and press the **ENT/CNTR** key.
4. Select [Load WPT/RTE <- USB], and press the **ENT/CNTR** key.

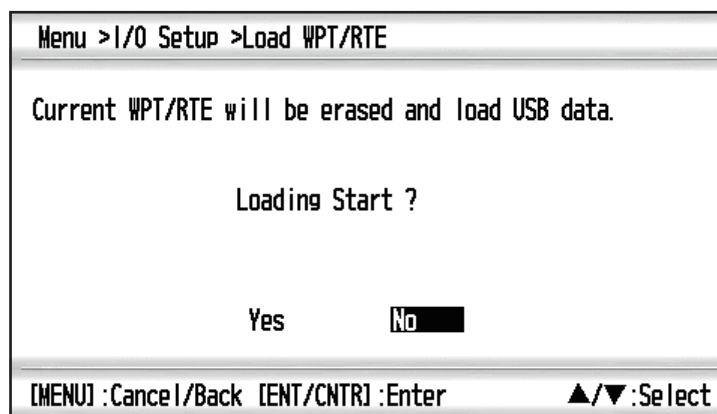

5. Press ◀ to select [Yes], and press the **ENT/CNTR** key to start the downloading.
6. After the completion message appears, press any key to finish.

7.8.3 Importing data from GP-32

Waypoint and route data can be imported from GP-32 to GP-39 by connecting two GP units with serial cable.

Preparation

1. Connect the serial cables of GP-32 and GP-39 as below illustration using the signal converter.

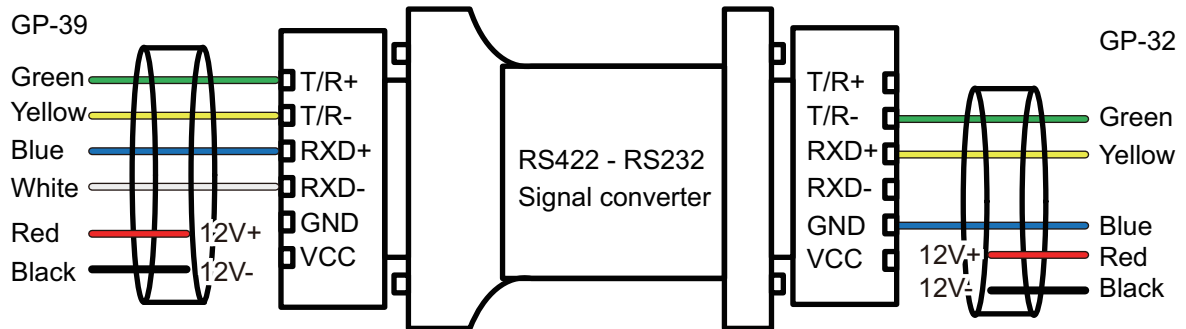

2. Turn on the display units of GP-32 and GP-39.

Operation on GP-39

1. Press the **MENU** key to show the main menu.
2. Select [I/O Setup], and press the **ENT/CNTR** key.
3. Select [Load WPT/RTE <- USB], and press the **ENT/CNTR** key.
4. Select [Yes] and press the **ENT/CNTR** key.

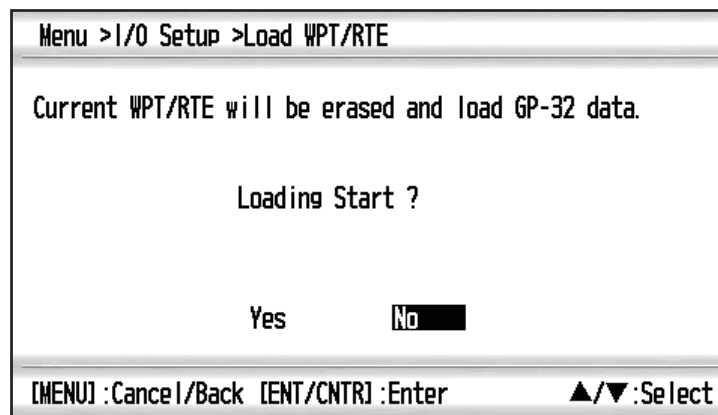

Note: After selecting [Yes], all waypoints and routes are erased from GP-32.

5. The below screen appears on the GP-39 display.

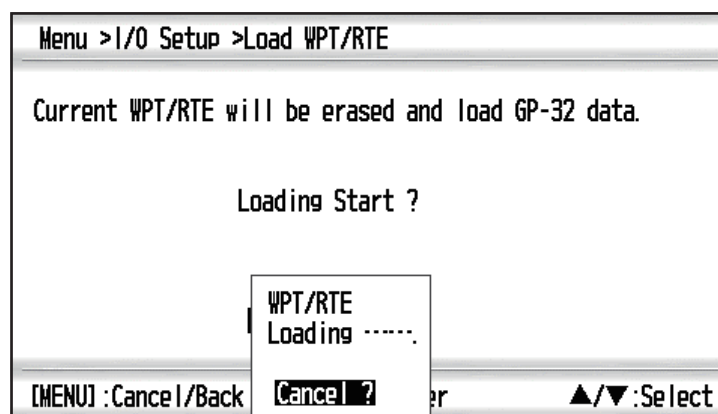

7. OTHER FUNCTIONS

Operation on GP-32

Only after the operation on GP-39 is done, proceed to operate the GP-32.

1. Press the **MENU** key to show the main menu.
2. Select [I/O Setup], and press the **ENT** key.
3. Select [Save WPT/RTE -> PC?], and press the **ENT** key to select [CONTINUE?].

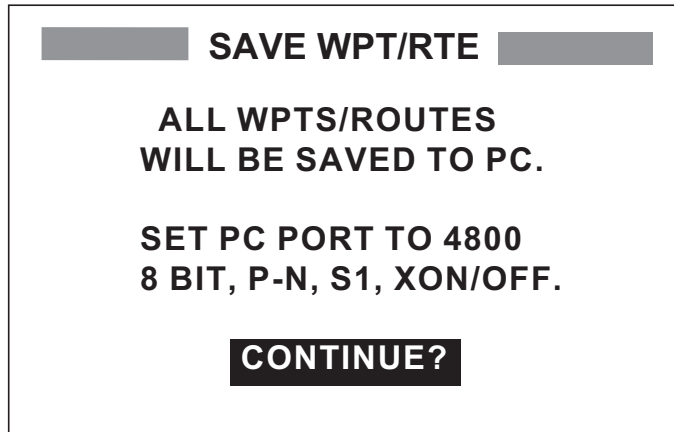

4. Below message pops-up. Select [YES] and press the **ENT** key.

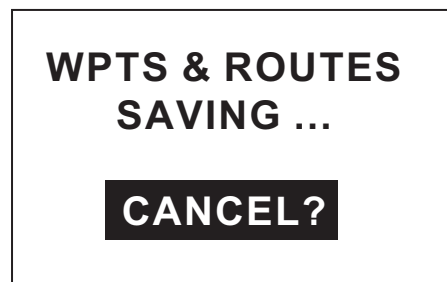
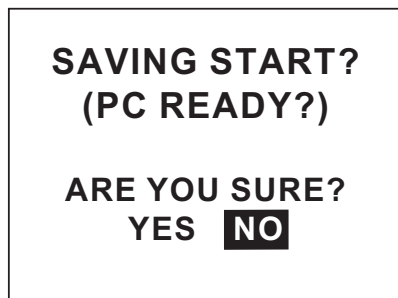

Data is being saved.
To cancel, press the [ENT] key.

When data transfer from GP-32 to GP-39 completed

GP-32 shows below pop-up message.



GP-39 shows below pop-up message.

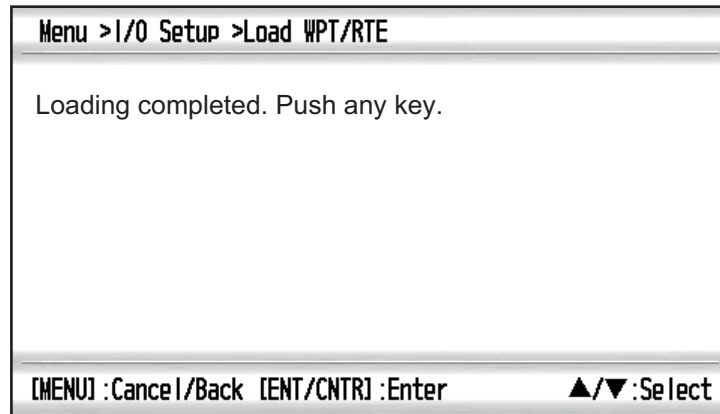

7. OTHER FUNCTIONS

This page is intentionally left blank.

8. MAINTENANCE, TROUBLE-SHOOTING

NOTICE

Do not apply paint, anti-corrosive sealant or contact spray to plastic parts or equipment coating.

Those items contain products that can damage plastic parts and equipment coating.

8.1 Maintenance

Regular maintenance is important to maintain performance. Check the following points to help maintain performance.

- Check that connectors on the rear panel are firmly tightened and free of rust.
- Check that the ground system is free of rust and the ground wire is tightly fastened.
- Check that battery terminals are clean and free of rust.
- Dust or dirt may be removed from the cabinet with soft cloth. Water-diluted mild detergent may be used if desired. DO NOT use chemical cleaners to clean the display unit; they may remove paint and markings.
- Wipe the LCD carefully to prevent scratching, using tissue paper and a soft cloth. To remove dirt or salt, use a damp soft cloth, wiping slowly so as to dissolve the dirt or salt. Rinse the cloth regularly so the dirt or salt will not scratch the LCD. Do not use solvents such as thinner, acetone or benzene for cleaning. Also, do not use degreaser or antifog solution, as they can strip the coating from the LCD.

Life of LCD

The life of the LCD is approximately 30,000 hours. The actual number of hours depends on ambient temperature and humidity. When the brilliance cannot be raised sufficiently, ask your dealer about replacement.

8.2 Troubleshooting

This section provides simple troubleshooting procedures which the user can follow to restore normal operation. If you cannot restore normal operation, do not attempt to check inside the unit. Any trouble should be referred to a qualified technician.

Symptom	Remedy
You cannot turn on the power.	Check that power cable is firmly fastened.
	Check for damaged power cable and connector.
	Check battery for proper voltage output.
No picture appears.	Press the  /BRILL key several times to adjust the brilliance.
There is no response when a key is pressed.	Turn off and on the power. If no change, ask your dealer.
Position is not fixed within 90 seconds.	Check that antenna connector is firmly fastened.
	Check the number of satellites on Satellite Monitor display. If there are two or less, check for obstructions between antenna unit and satellites.
Position is wrong.	Check that the correct geodetic chart system is selected on the GPS Setting screen.
	Enter position offset on the GPS Setting screen.
Loran C/Decca TDs do not appear.	Check Loran C/Decca chain data on the Pos/TD Setup screen.
Loran C/Decca TDs are wrong.	Enter TD offset on the Pos/TD Setup screen.
Bearing is wrong.	Check Magnetic Variation on the Plotter Setup screen.

8.3 Displaying the Message Board

When an error occurs, a message and an alarm icon appear on the screen. The message board displays the error messages (see page 6-2) shown in table below.

Messages and meanings

Message	Meaning, remedy
GPS ERROR!	Request service.
GPS NO FIX!	No GPS signal. Check antenna cable.
RAM ERROR!	Request service.
ROM ERROR!	Request service.
BACKUP ERROR!	RAM data corrupted. Try to clear backup data.

8.4 Diagnostics

The diagnostic test checks the ROM, RAM, input data, GPS core, keyboard and LCD performance. The user can do the tests to help the service technician in troubleshooting.

Note: Do not pull out or plug in the USB flash memory during [Self Test].

1. Press the **MENU** key twice to show the menu.
2. Select [System], and press the **ENT/CNTR** key.
3. Select [Self Test], and press the **ENT/CNTR** key.

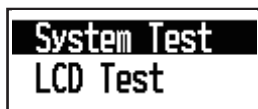

4. Select [System Test], and press the **ENT/CNTR** key to start the test. The results are individually displayed as OK or NG (No Good). If NG appears, try the test again. If NG re-appears, contact your dealer for advice.

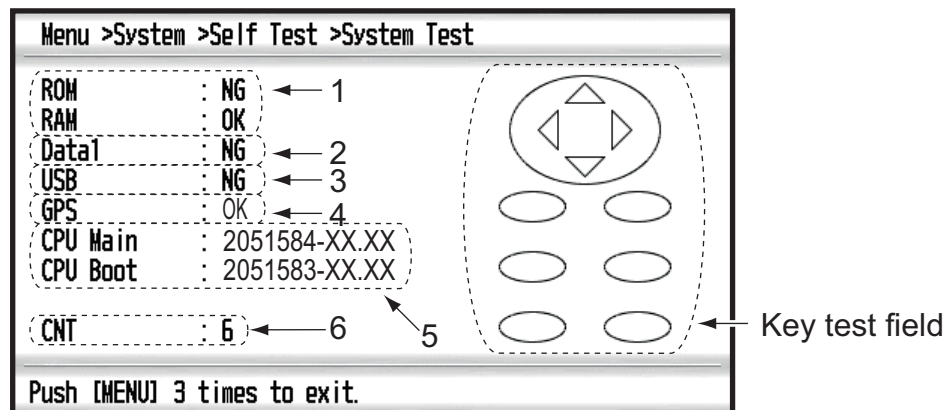

XX: Program version No.

No.	Test Items	Description
1	ROM, RAM test	Correct: "OK", Wrong: "NG"
2	Data3 test	"-" (This test is used at factory only.)

No.	Test Items	Description
3	USB	Correct: "OK", Wrong: "NG"
4	GPS test	Correct: "OK", Wrong: "NG"
5	Program version No.	The program version No. which is currently used appears.
6	CNT	Number of test repetition.

5. Press each key one by one.
The corresponded mark on the display turns red if the key is functioning properly.
6. Press the **MENU** key three times to close the test screen.
7. Select [LCD Test], and press the **ENT/CNTR** key.
Each press of this key changes the LCD pattern in the sequence shown below.
Red→Green→Blue→Red (gradation)→Green (gradation)→Blue (gradation)→White→Black→White/Black (gradation)→return to System screen.
Note: To cancel the test, press the **MENU** key.
8. Press the **MENU** key twice to close the menu.

8.5 Clearing Data

You can clear GPS data, menu settings* and all backup data* to start afresh (*excludes Language, Units and TD).

1. Press the **MENU** key twice to show the menu.
2. Select [System], and press the **ENT/CNTR** key.
3. Select [Reset], and press the **ENT/CNTR** key.

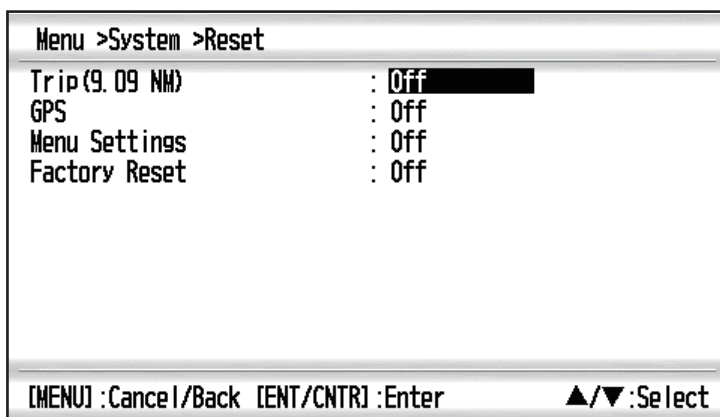

4. Select [GPS], [Menu Settings] or [Factory Reset], and press the **ENT/CNTR** key.
5. Select [On], and press the **ENT/CNTR** key.
6. Press ◀ to select [Yes], and press the **ENT/CNTR** key.
[Menu Settings], [Factory Reset]: Go to Initial Setting screen. Select the language, then press **ENT/CNTR** and **MENU** key in order.

9. INSTALLATION

9.1 Equipment Lists

Standard Supply

Name	Type	Code No.	Qty	Remarks
Display unit	GP-39	000-029-443	1	
Antenna Unit	GPA-017	000-029-316	1	w/10 m cable
Spare Parts	SP20-01601	001-435-700	1	Fuse FGMB 125V 1.5A PBF
Installation Materials	CP20-03901	001-435-710	1	Self-tapping screw 5 × 16, 4 pcs.
	CP20-03900	001-435-720	1	
Accessories	FP20-01300	001-435-730	1	Plastic bag

Optional Supply

Name	Type	Code No.	Qty	Remarks
Flush Mount Kit F	OP20-45	001-435-860	1	
Flush Mount Kit S	OP20-46	001-435-870	1	
Mast Mounting Kit	CP20-01111	004-365-780	1	
Operator's Manual	OME-44940-*	001-435-850	1	

9.2 Installation of Display Unit

9.2.1 Installation consideration

The display unit can be installed on a desktop, underside of table or in a panel. Refer to the outline drawings at the end of this manual for installation instructions. When selecting a mounting location, keep in mind the following points:

- Locate the unit away from exhaust pipes and vents.
- The mounting location should be well ventilated.
- Mount the unit where shock and vibration are minimal.
- Locate the unit away from equipment which generates electromagnetic fields such as a motor or generator.
- Allow sufficient maintenance space at the sides and rear of the unit and leave sufficient slack in cables, to facilitate maintenance and service.
- Observe compass safe distances noted on SAFETY INSTRUCTIONS to prevent interference to a magnetic compass.
- Locate the unit away from direct sunlight. The LCD display may black out if it is exposed to direct sunlight for a long time.

9.2.2 Desktop mount

1. Detach the display unit from the hanger.

Note: To detach the display unit from the hanger, align the arrow marks on the unit and hanger. If the arrows are not aligned when you detach the unit, you may damage the unit or the hanger.

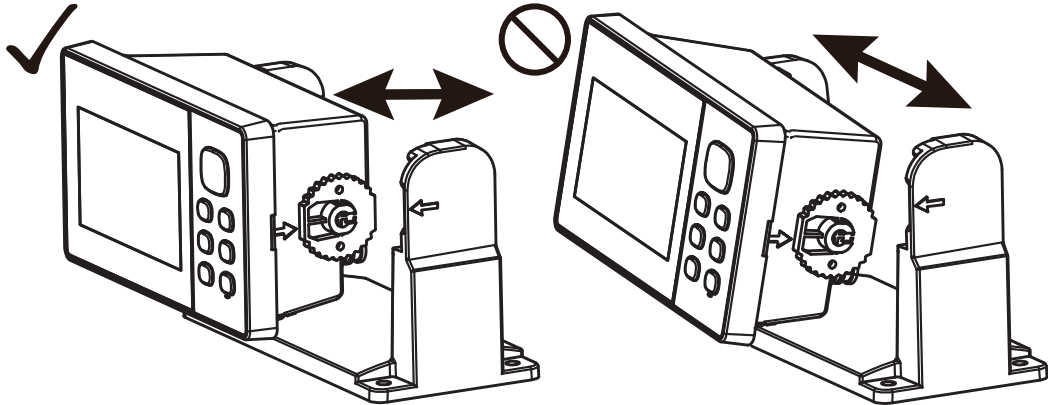

2. Prepare four pilot holes (for 5×16 self-tapping screws) at the mounting location.
3. Fix the hanger to the mounting location with four self-tapping screws (5×16, supplied).

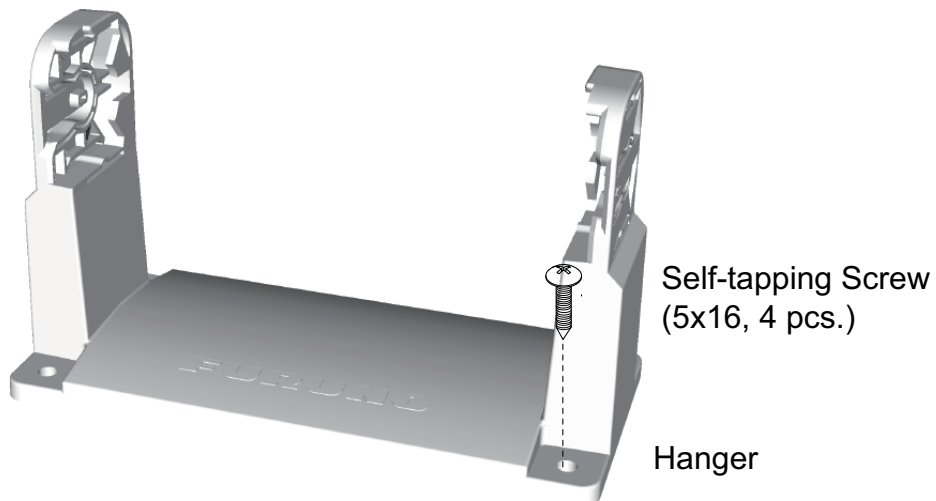

4. Attach cables to the back of the display unit.
5. Attach the display unit to the hanger.
Note: To attach the display unit to the hanger, align the arrow marks on the unit and hanger.

9.2.3 Flush mount

Using Flush Mount Kit F (OP20-45)

An optional flush mount kit type F is required. The table below shows the contents of the OP20-45 kit.

Name: Flush Mount Kit F, Type: OP20-45, Code No. 001-435-860

Name	Type	Code No.	Qty
Self-tapping screw	4 × 8 SUS304	000-163-797-10	4
Cosmetic panel	20-038-1201	100-406-600-10	1
Self-tapping screw	5 × 16 SUS304	000-162-607-10	4

1. Using the template (supplied), cut out a hole in the mounting location.
2. Prepare four pilot holes (for 5x16 self-tapping screws) at the mounting location.
3. Detach the display unit from the hanger.
This hanger can be discarded.
4. Attach the flush mount kit F to the display unit using four self-tapping screws (4 × 8) to fasten the kit F to the display unit.

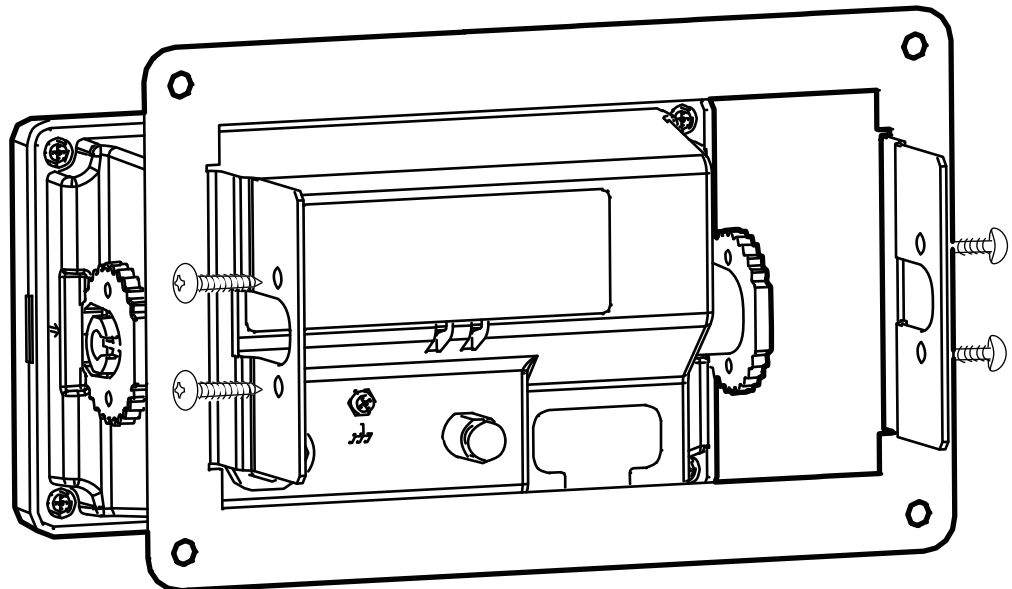

5. Attach the display unit and flush mount kit F to the hole made at step 1.
6. Connect cables to the back of the display unit.
7. Use four self-tapping screws to fasten the display unit to the mounting location.

Self-tapping Screw
(5 × 16, 4 pcs.)

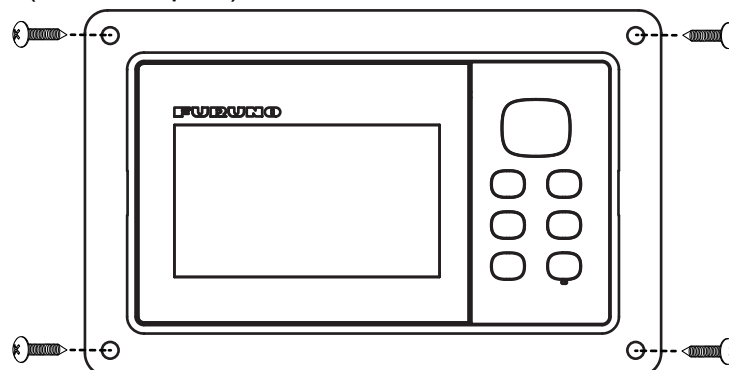

Using Flush Mount Kit S (OP20-46)

An optional flush mount kit type S is required. The table below shows the contents of the OP20-46 kit.

Name: Flush Mount Kit F, Type: OP20-46, Code No. 001-435-780

Name	Type	Code No	Qty
Self-tapping screw	4 × 8 SUS304	000-163-797-10	4
Butterfly bolt	M4 × 35 SUS304	000-163-933-10	4
Butterfly nut	M4 SUS304	000-167-545-10	4
Flush mount metal	20-038-1101-0	100-406-570-10	2
Mount S Sponge	20-038-1102-0	100-406-580-10	1

1. Using the template (supplied), cut out a hole in the mounting location.
2. Detach the display unit from the hanger.
This hanger can be discarded.
3. Attach the Mount S Sponge (supplied) at the back of the display unit.
4. Set the display unit into the mounting hole. Make sure that the display unit is not tilted and has a service space more than 100 mm at the back of unit.
5. Attach the flush mount metal (supplied) to the both sides of display unit using four self-tapping screws (4 × 8) to fasten the kit S to the display unit.

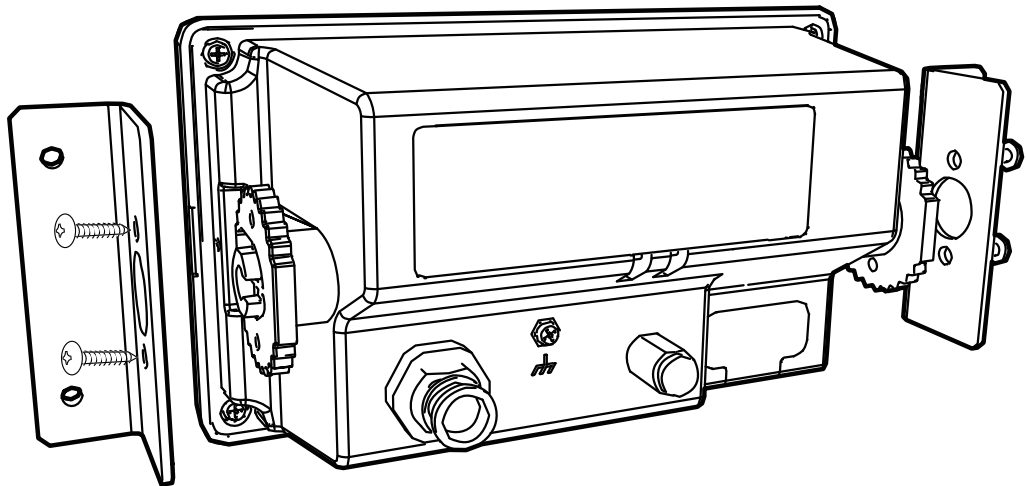

6. Tighten the butterfly bolts and butterfly nuts (supplied) from the back of display unit.

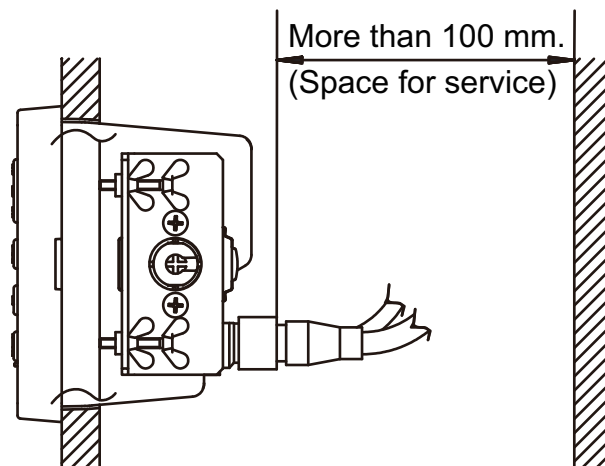

9.3 Installation of Antenna Unit

Install the antenna unit referring to the antenna installation diagram at the back of this manual. When choosing a mounting location for the antenna unit, keep in mind the following points:

- Select a location out of the radar beam. The radar beam will obstruct or prevent reception of the GPS signal.
- The location should be well away from a VHF/UHF antenna. VHF/UHF antenna emit harmonic waves which can interfere with the GPS receiver.
- There should be no interfering object within the line-of-sight to the satellites. An object within line-of-sight to satellites, for example, a mast, may block reception or prolong acquisition time.
- Mount the antenna unit as high as possible to keep it free from interfering objects and water spray. Freezing water can interrupt reception of the GPS satellite signal.

Note 1: Do not shorten the antenna cable.

Note 2: If the antenna cable is to be passed through a hole which is not large enough to pass the connector, disconnect the connector with needle nose pliers and a 3/8-inch open-end wrench. Reconnect the connector as shown below, after running the cable through the hole.

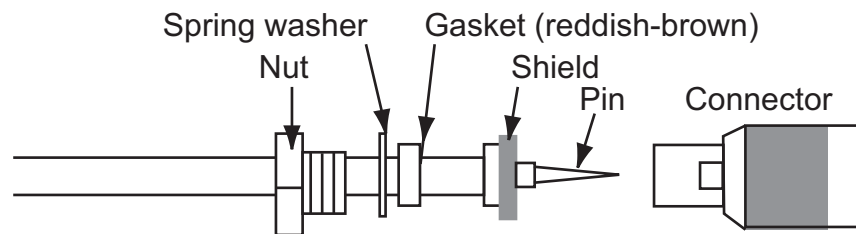

9.4 Language Setting

When you first turn the power on after installation, you are asked the language to use on the equipment. Press ▲ or ▼ to select the language, and press the **ENT/CNTR** key.

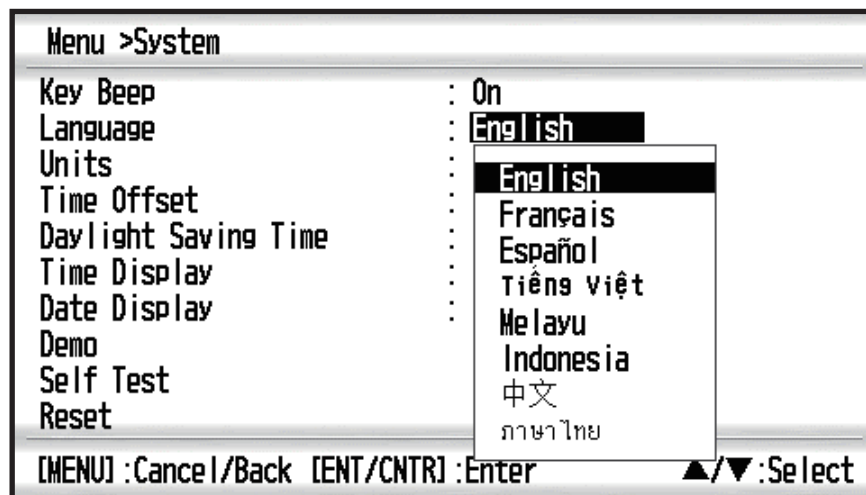

9.5 Input/Output Data

This equipment inputs/outputs NMEA0183 data shown below. Note that NMEA0183 version (1.5/2.0/3.0) can be selected from the I/O setup screen.

NMEA0183 Input Sentence

Talker	Format	Note
GP	RTE	
PFEC, GPwp1		
PFEC, GPrtc		
PFEC, GPxfr		
PFEC, cprst		
SD	TLL	Request for Target
PFEC, SDmrk		Mark Additional information of longitude, latitude and its position.

NMEA0183 Output Sentence

Format**	REM1	REM2	AP	GPS
AAM*			ON	
APB*			ON	
BOD*			ON	
BWC*		ON	ON	
BWR*		ON	ON	
DTM	ON	ON		
GGA	ON	ON		ON
GLL	ON		ON	
GSA				ON
GSV				ON
RMB*	ON	ON		
RMC	ON	ON		
VTG	ON	ON	ON	ON
XTE			ON	
ZDA	ON	ON	ON	

Other output sentences:

REM1/REM2: Output data to radar, echo sounder and so on.

AP: Mainly output data to an autopilot.

GPS: Mainly output GPS satellite information for serviceman.

*: Not output when no waypoint is set.

** : Talker; GP

Output setting

1. Press the **MENU** key twice to show the main menu.
2. Select [I/O Setup], then press the **ENT/CNTR** key.
3. Select [Data 1] or [NMEA0183 Version] depending on the equipment connected.
4. Press the **ENT/CNTR** key. One of the following screens appears depending on the item selected at step 3.

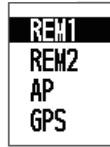

"Data1"

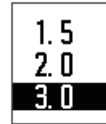

"NMEA0183 Version"

5. Press ▲ or ▼ to select the option.
 [REM1], [REM2]: Output data to radar, echo sounder.
 [AP]: Output data to an autopilot.
 [GPS]: Output GPS data (used for the service)
 [1.5], [2.0], [3.0]: select the NMEA version of external equipment. If you are unsure of the version number, try both and select the one which successfully outputs data.
6. Press the **ENT/CNTR** key.
7. Press the **MENU** key twice to close the menu.

9. INSTALLATION

This page is intentionally left blank.

APPENDIX 1 MENU TREE

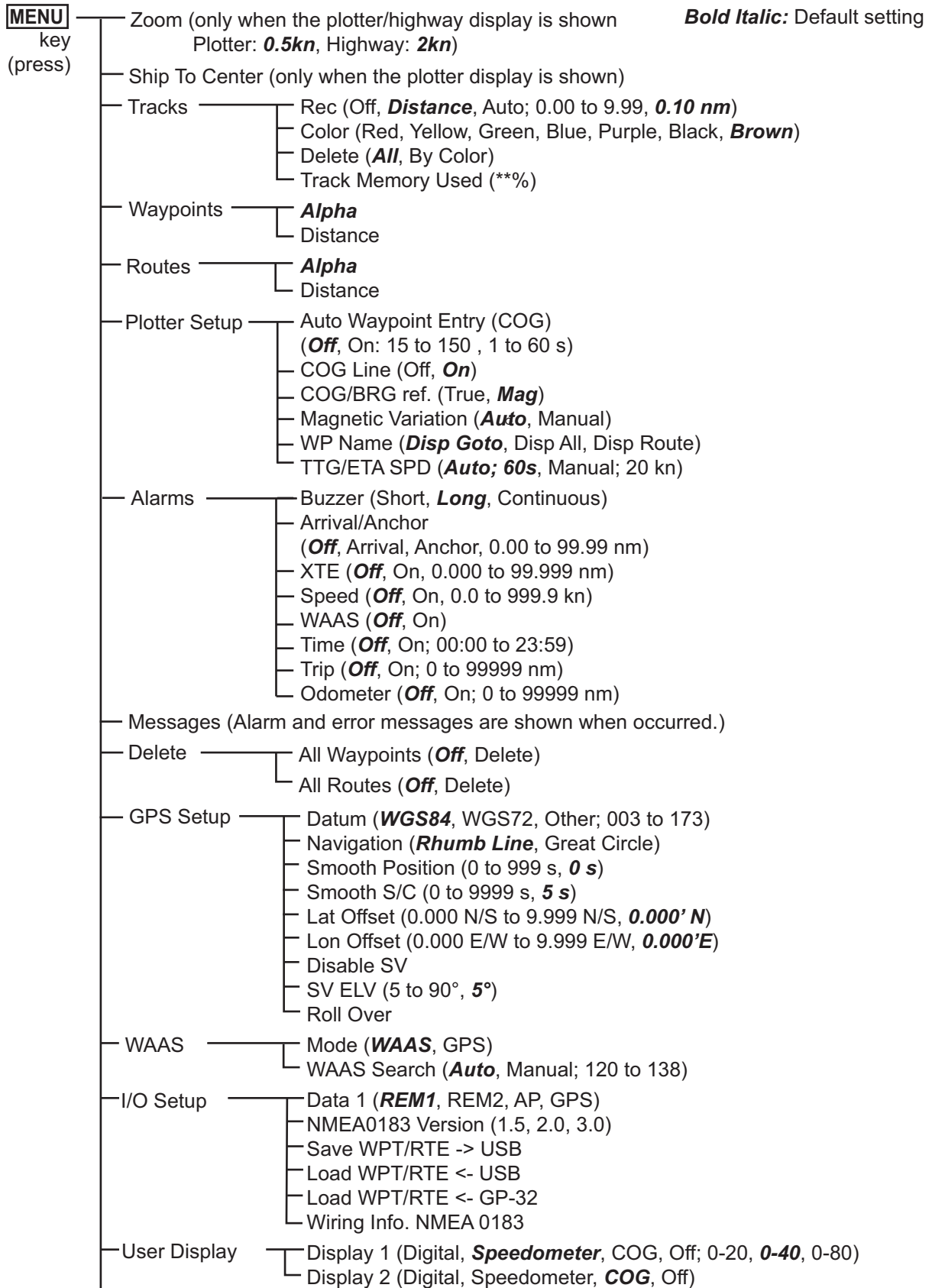

① (Continued on next page.)

APPENDIX 1 MENU TREE

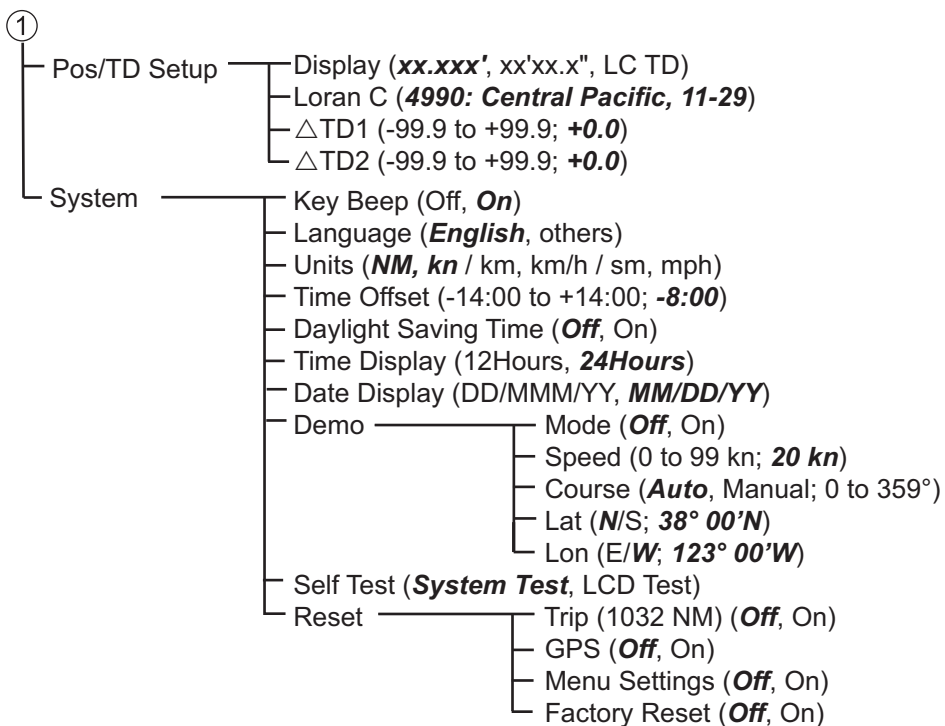

APPENDIX 2 WHAT IS SBAS?

A satellite based augmentation system, or SBAS (Satellite Based Augmentation System), is an augmentation system that uses additional messages from satellite broadcasts to support regional and wide area augmentation. SBAS provides GPS signal corrections to SBAS users, for even better position accuracy, through the GPS error corrections that are widely broadcasted from the geostationary satellite.

SBAS is used in America, Europe, Japan and India.

- America: WAAS (Wide Area Augmentation System)
- Europe: EGNOS (Euro Geostationary Navigation Overlay Service)
- Japan: MSAS (Multi-Functional Satellite Augmentation System)
- India: GAGAN (GPS And GEO Augmented Navigation)

These four systems have interoperability. The illustration below shows the coverage area for each provider. This manual uses “SBAS” for these four providers generically.

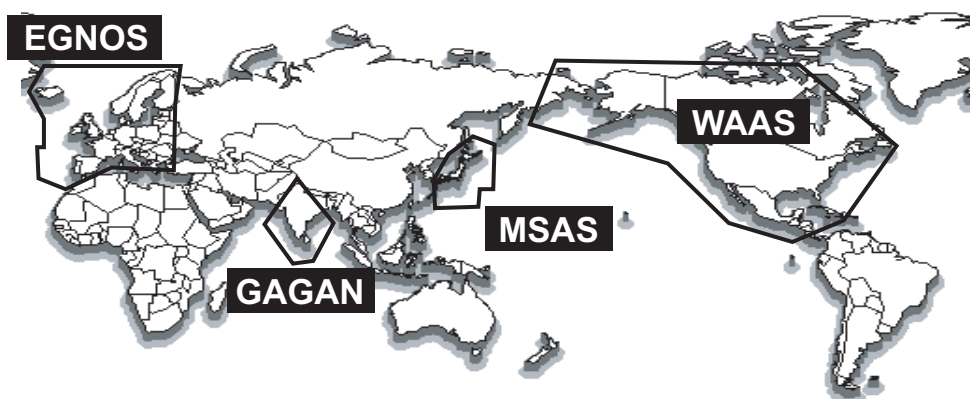



Provider	Satellite type	Longitude	Satellite No.
WAAS	Intelsat Galaxy XV	133°W	135
	TeleSat Anik F1R	107.3°W	138
	Inmarsat-4-F3	98°W	133
EGNOS	Inmarsat-3-F2/AOR-E	15.5°W	120
	Inmarsat-4-F2	25°E	126
	SES-5	5°E	136
MSAS	MTSAT-1R	140°E	129
	MTSAT-2	145°E	137
GAGAN	GSAT-8	55°E	127
	GSAT-10	83°E	128

As of March 6th, 2014

APPENDIX 3 LIST OF TERMS

The following table shows the terms used in GP-39.

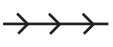
Terms/Symbols	Meaning	Terms/Symbols	Meaning
	Waypoints	Lat	Latitude
		Lon	Longitude
	Own Ship	LC	Loran-C
"M"	Man Overboard	M, Mag	Magnetic
	Shortest course to the destination	MAR	March
+	Cursor	MAY	May
%	Percentage	MM (MMM)	Month
2D, 3D	2D/3D GPS position fix	mph	mile per hour
W2D, W3D	2D/3D WAAS position fix	N	North
AP	Autopilot	nm	Nautical Mile
APR	April	NMEA	National Marine Electronics Association
AUG	August	NOV	November
Auto	Automatic	OCT	October
Brill	Brilliance	ODO	Odometer
BRG	Bearing	PDOP	Position Dilution Of Precision
Cmnt	Comment	Pos	Position
COG	Course Over Ground	ref.	Reference
DD	Day	QP	Quick Point
DE	Decca	REM	Remote
DEC	December	RNG	Range
Demo, SIM	Demonstration Mode	RTE, RT	Route
Disp	Display	S	South
DOP	Dilution Of Precision	s	seconds
E	East	S/C	Speed/Course
ELV	Elevation	SEP	September
ENT/CNTR	Enter	sm	Statute Mile
ETA	Estimated Time of Arrival	SOG	Speed Over Ground
FEB	February	SPD	Speed
G	Go to	T	True
GPS	Global Positioning System	TD	Time Difference
I/O	Input/Output	TTG	Time To Go
HDOP	Horizontal Dilution Of Precision	Volt	Voltage
JAN	January	W	West
JUL	July	WAAS	Wide Area Augmentation System
JUN	June	WPT, WP	Waypoint
km	kilometer	XTE	Cross Track Error
kn	knot	YY	Year

APPENDIX 4 GEODETIC CHART LIST

001: WGS84		
002: WGS72		
003: TOKYO	: Mean Value (Japan, Korea & Okinawa)	
004: NORTH AMERICAN 1927	: Mean Value (CONUS)	
005: EUROPEAN 1950	: Mean Value	
006: AUSTRALIAN GEODETIC 1984	: Australia & Tasmania	
007: ADINDAN	: Mean Value (Ethiopia & Sudan)	
008: ADINDAN	: Ethiopia	
009: ADINDAN	: Mali	
010: ADINDAN	: Senegal	
011: ADINDAN	: Sudan	
012: AFG	: Somalia	
013: AIN EL ABD 1970	: Bahrain Is.	
014: ANNA 1 ASTRO 1965	: Cocos Is.	
015: ARC 1950	: Mean Value	
016: ARC 1950	: Botswana	
017: ARC 1950	: Lesotho	
018: ARC 1950	: Malawi	
019: ARC 1950	: Swaziland	
020: ARC 1950	: Zaire	
021: ARC 1950	: Zambia	
022: ARC 1950	: Zimbabwe	
023: ARC 1960	: Mean Value (Kenya & Tanzania)	
024: ARC 1960	: Kenya	
025: ARC 1960	: Tanzania	
026: ASCENSION IS. 1958	: Ascension Is.	
027: ASTRO BEACON "E"	: Iwo Jima Is.	
028: ASTRO B4 SOR. ATOLL	: Tern Is.	
029: ASTRO POS 71/4	: St. Helena Is.	
030: ASTRONOMIC STATION 1952	: Marcus Is.	
031: AUSTRALIAN GEODETIC 1966	: Australia & Tasmania	
032: BELLEVUE (IGN)	: Efate & Erromango Is.	
033: BERMUDA 1957	: Bermuda Is.	
034: BOGOTA OBSERVATORY	: Columbia	
035: CAMPO INCHAUSPE	: Argentina	
036: CANTON IS. 1966	: Phoenix Is.	
037: CAPE	: South Africa	
038: CAPE CANAVERAL	: Mean Value (Florida & Bahama Is.)	
039: CARTHAGE	: Tunisia	
040: CHATHAM 1971	: Chatham Is. (New Zealand)	
041: CHUA ASTRO	: Paraguay	
042: CORREGO ALEGRE	: Brazil	
043: DJAKARTA (BATAVIA)	: Sumatra Is. (Indonesia)	
044: DOS 1968	: Gizo Is. (New Georgia Is.)	
045: EASTER IS. 1967	: Easter Is.	
046: EUROPEAN 1950 (Cont'd)	: Western Europe	
047: EUROPEAN 1950 (Cont'd)	: Cyprus	
048: EUROPEAN 1950 (Cont'd)	: Egypt	
049: EUROPEAN 1950 (Cont'd)	: England, Scotland, Channel & Shetland Is.	
050: EUROPEAN 1950 (Cont'd)	: England, Ireland, Scotland & Shetland Is.	
051: EUROPEAN 1950 (Cont'd)	: Greece	
052: EUROPEAN 1950 (Cont'd)	: Iran	
053: EUROPEAN 1950 (Cont'd)	: Italy, Sardinia	
054: EUROPEAN 1950 (Cont'd)	: Italy, Sicily	
055: EUROPEAN 1950 (Cont'd)	: Norway & Finland	
056: EUROPEAN 1950 (Cont'd)	: Portugal & Spain	
057: EUROPEAN 1979	: Mean Value	
058: GANDAJIKA BASE	: Republic of Maldives	
059: GEODETIC DATUM 1949	: New Zealand	
060: GUAM 1963	: Guam Is.	
061: GUX 1 ASTRO	: Guadalcanal Is.	
062: HJORSEY 1955	: Iceland	
063: HONG KONG 1963	: Hong Kong	
064: INDIAN	: Thailand & Vietnam	
065: INDIAN	: Bangladesh, India & Nepal	
066: IRELAND 1965	: Ireland	
067: ISTS 073 ASTRO 1969	: Diego Garcia	
068: JOHNSTON IS. 1961	: Johnston Is.	
069: KANDAWALA	: Sri Lanka	
070: KERGUELEN IS.	: Kerguelen Is.	
071: KERTAU 1948	: West Malaysia & Singapore	
072: LA REUNION	: Mascarene Is.	
073: L. C. 5 ASTRO	: Cayman Brac Is.	
074: LIBERIA 1964	: Liberia	
075: LUZON	: Philippines (excl. Mindanao Is.)	
076: LUZON	: Mindanao Is.	
077: MAHE 1971	: Mahe Is.	
078: MARCO ASTRO	: Salvage Islands	
079: MASSAWA	: Eritrea (Ethiopia)	
080: MERCHICH	: Morocco	
081: MIDWAY ASTRO 1961	: Midway Is.	
082: MINNA	: Nigeria	
083: NAHRWAN	: Masirah Is. (Oman)	
084: NAHRWAN	: United Arab Emirates	
085: NAHRWAN	: Saudi Arabia	
086: NAMIBIA	: Namibia	
087: MAPARIMA, BWI	: Trinidad & Tobago	
088: NORTH AMERICAN 1927	: Western United States	
089: NORTH AMERICAN 1927	: Eastern United States	
090: NORTH AMERICAN 1927	: Alaska	
091: NORTH AMERICAN 1927	: Bahamas (excl. San Salvador Is.)	
092: NORTH AMERICAN 1927	: Bahamas, San Salvador Is.	
093: NORTH AMERICAN 1927 (Cont'd)	: Canada (incl. Newfoundland Is.)	
094: NORTH AMERICAN 1927 (Cont'd)	: Alberta & British Columbia	
095: NORTH AMERICAN 1927 (Cont'd)	: East Canada	
096: NORTH AMERICAN 1927 (Cont'd)	: Manitoba & Ontario	
097: NORTH AMERICAN 1927 (Cont'd)	: Northwest Territories & Saskatchewan	
098: NORTH AMERICAN 1927 (Cont'd)	: Yukon	
099: NORTH AMERICAN 1927 (Cont'd)	: Canal Zone	
100: NORTH AMERICAN 1927 (Cont'd)	: Caribbean	
101: NORTH AMERICAN 1927 (Cont'd)	: Central America	
102: NORTH AMERICAN 1927 (Cont'd)	: Cuba	
103: NORTH AMERICAN 1927 (Cont'd)	: Greenland	
104: NORTH AMERICAN 1927 (Cont'd)	: Mexico	
105: NORTH AMERICAN 1983	: Alaska	
106: NORTH AMERICAN 1983	: Canada	
107: NORTH AMERICAN 1983	: CONUS	
108: NORTH AMERICAN 1983	: Mexico, Central America	
109: OBSERVATORIO 1966	: Corvo & Flores Is. (Azores)	
110: OLD EGYPTIAN 1930	: Egypt	
111: OLD HAWAIIAN	: Mean Value	
112: OLD HAWAIIAN	: Hawaii	
113: OLD HAWAIIAN	: Kauai	
114: OLD HAWAIIAN	: Maui	
115: OLD HAWAIIAN	: Oahu	
116: OMAN	: Oman	
117: ORDNANCE SURVEY OF GREAT BRITAIN 1936	: Mean Value	
118: ORDNANCE SURVEY OF GREAT BRITAIN 1936	: England	
119: ORDNANCE SURVEY OF GREAT BRITAIN 1936	: England, Isle of Man & Wales	
120: ORDNANCE SURVEY OF GREAT BRITAIN 1936	: Scotland & Shetland Is.	
121: ORDNANCE SURVEY OF GREAT BRITAIN 1936	: Wales	
122: PICO DE LAS NIVIAS	: Canary Is.	
123: PITCAIRN ASTRO 1967	: Pitcairn Is.	
124: PROVISIONAL SOUTH CHILEAN 1963	: South Chile (near 53°S)	
125: PROVISIONAL SOUTH AMERICAN 1956	: Mean Value	
126: PROVISIONAL SOUTH AMERICAN 1956	: Bolivia	
127: PROVISIONAL SOUTH AMERICAN 1956	: Chile-Northern Chile (near 19°S)	
128: PROVISIONAL SOUTH AMERICAN 1956	: Chile-Southern Chile (near 43°S)	
129: PROVISIONAL SOUTH AMERICAN 1956	: Columbia	
130: PROVISIONAL SOUTH AMERICAN 1956	: Ecuador	
131: PROVISIONAL SOUTH AMERICAN 1956	: Guyana	
132: PROVISIONAL SOUTH AMERICAN 1956	: Peru	
133: PROVISIONAL SOUTH AMERICAN 1956	: Venezuela	
134: PUERTO RICO	: Puerto Rico & Virgin Is.	
135: QATAR NATIONAL	: Qatar	
136: QORNOQ	: South Greenland	
137: ROME 1940	: Sardinia Is.	
138: SANTA BRAZ	: Sao Miguel, Santa Maria Is. (Azores)	
139: SANTO (DOS)	: Espirito Santo Is.	
140: SAPPER HILL 1943	: East Falkland Is.	
141: SOUTH AMERICAN 1969	: Mean Value	
142: SOUTH AMERICAN 1969	: Argentina	
143: SOUTH AMERICAN 1969	: Bolivia	
144: SOUTH AMERICAN 1969	: Brazil	
145: SOUTH AMERICAN 1969	: Chile	
146: SOUTH AMERICAN 1969	: Columbia	
147: SOUTH AMERICAN 1969	: Ecuador	
148: SOUTH AMERICAN 1969	: Guyana	
149: SOUTH AMERICAN 1969	: Paraguay	
150: SOUTH AMERICAN 1969	: Peru	
151: SOUTH AMERICAN 1969	: Trinidad & Tobago	
152: SOUTH AMERICAN 1969	: Venezuela	
153: SOUTH ASIA	: Singapore	
154: SOUTHEAST BASE	: Porto Santo & Madeira Is.	
155: SOUTHWEST BASE	: Faial, Graciosa, Pico, Sao Jorge & Terceira Is.	
156: TIMBALAI 1948	: Brunei & East Malaysia (Sarawak & Sabah)	
157: TOKYO	: Japan	
158: TOKYO	: Korea	
159: TOKYO	: Okinawa	
160: TRISTAN ASTRO 1968	: Tristan da Cunha	
161: VITI LEVU 1916	: Viti Levu Is. (Fiji Is.)	
162: WAKE-ENIWETOK 1960	: Marshall Is.	
163: ZANDERIJ	: Surinam	
164: BUKIT RIMPAH	: Bangka & Belitung Is. (Indonesia)	
165: CAMP AREA ASTRO	: Camp Morduro Area, Antarctica	
166: G. SEGARA	: Kalimantan Is. (Indonesia)	
167: HERAT NORTH	: Afghanistan	
168: HU-TZU-SHAN	: Taiwan	
169: TANANARIVE OBSERVATORY 1925	: Madagascar	
170: YACARE	: Uruguay	
171: RT-90	: Sweden	
172: PULKOVO 1942	: Russia	
173: FINNISH KKK	: Finland	

This page is intentionally left blank.

**SPECIFICATIONS OF GPS RECEIVER
GP-39**

1 ANTENNA UNIT

- 1.1 Receiving channel
 - GPS 12 channels parallel, 12 satellites tracking
 - SBAS 2 channels
- 1.2 Rx frequency 1575.42 MHz ±1.023 MHz
- 1.3 Rx code GPS: C/A code, SBAS: L1 C/A
- 1.4 Position fixing system All in view, 8 state Kalman filter
- 1.5 Position accuracy
 - GPS 10 m (95% of the time, HDOP ≤4)
 - WAAS 3 m (95% of the time, HDOP ≤4)
 - MSAS 7 m (95% of the time, HDOP ≤4)
- 1.6 Tracking velocity 1000 kn
- 1.7 Position fixing time Warm start: 30 s approx, Cold start: 90 s approx.
Hot start: 1 s approx.
- 1.8 Position update interval 1 s

2 DISPLAY UNIT

- 2.1 Display system 4.2-inch Color LCD, 480 x 272 dots, 92.88 (W) x 52.632 (H) mm
- 2.2 Display mode Plotter, Highway, Steering, NAV data, Satellite monitor,
User display
- 2.3 Brilliance 700 cd/m² nominal
- 2.4 Projection Mercator
- 2.5 Range scale
 - Plotter 0.02/0.05/0.1/0.2/0.5/1/2/5/10/20/40/80/160/320 NM
 - Highway 0.2/0.4/0.8/1/2/4/8/16 NM
- 2.6 Memory capacity Track: 3000 pts, Waypoint: 10,000 pts w/ comment 13 character
- 2.7 Storage capacity 100 routes w/ 30 waypoint each
- 2.8 Alarms Arrival and anchor watch, Cross track error, Ship's speed, WAAS,
Time, Trip

3 INTERFACE

- 3.1 Number of ports NMEA0183 V1.5/2.0/3.0: 1 port, current loop
USB: 1 port, USB2.0
- 3.2 Data sentences
 - Input RTE, TLL
 - Output AAM, APB, BOD, BWC, BWR, DTM, GGA, GLL, GSA, GSV, RMB,
RMC, VTG, XTE, ZDA
- 3.3 Output proprietary sentences
 - PFEC GPrtst, GPrtc, GPwpl, GPxfr, SDmrk

4 POWER SUPPLY

4.1 Display unit 12-24 VDC: 0.7-0.3 A

5 ENVIRONMENTAL CONDITIONS

5.1 Ambient temperature

Antenna unit -25°C to +70°C (storage: -30°C to +75°C)

Display unit -15°C to +55°C (storage: -30°C to +75°C)

5.2 Relative humidity 93% or less at +40°C

5.3 Degree of protection

Antenna unit IP56

Display unit IP55

5.4 Vibration IEC 60945 Ed.4

6 UNIT COLOR

6.1 Antenna unit N9.5





6.2 Display unit N1.0

PACKING LIST

20BH-X-9851 -1 1/1

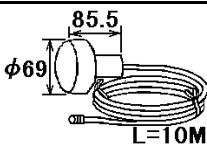
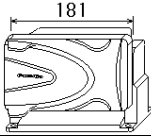
GP-39

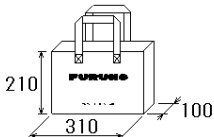
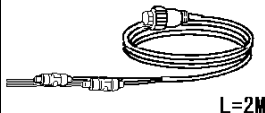
A-1

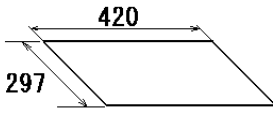
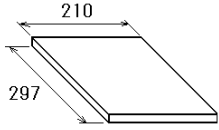
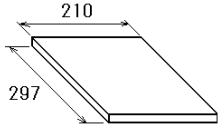
NAME	OUTLINE	DESCRIPTION/CODE No.	Q' TY
ユニット UNIT			
空中線部 ANTENNA UNIT		GPA-017 000-029-316-00	1
受信演算部 DISPLAY UNIT		GP-39 000-029-445-00	1
予備品 SPARE PARTS			
予備品 SPARE PARTS		SP20-01601 001-435-820-00	1
付属品 ACCESSORIES			
PLASTIC BAG PLASTIC BAG		20-038-1051-3 100-406-563-00	1
工事材料 INSTALLATION MATERIALS			
ケーブル(クミヒン)MJ CABLE ASSEMBLY		MJ-A7SPF0017-020+ 000-191-487-10	1
工事材料 INSTALLATION MATERIALS		CP20-03901 001-435-830-00	1
図書 DOCUMENT			
ユーザガイド(英) USER'S GUIDE (EN)		E42-01510-* 000-191-425-1*	1
操作要領書(中) OPERATOR'S GUIDE (CN)		NZS-44940-* 000-191-426-1*	1
装備要領書(多言語) OPERATOR'S GUIDE (MLG)		MLG-44940-* 000-191-422-1*	1

(略図の寸法は、参考値です。 DIMENSIONS IN DRAWING FOR REFERENCE ONLY.)

CN

C4494-Z01-B

PACKING LIST

OP20-45

20BH-X-9852 -0 1/1

NAME	OUTLINE	DESCRIPTION/CODE No.	QTY
KIT PARTS			
MOUNT F		20-038-1201-0	1
MOUNT F		100-406-600-10	
+		4X8 SUS	4
+		100-163-797-10	
+		5X16 SUS304	4
+		100-162-607-10	
図書			
フラッシュマウント型紙		E42-01511-*	1
FLUSH MOUNTING TEMPLATE		000-191-423-1*	

(略図の寸法は、参考値です。DIMENSIONS IN DRAWING FOR REFERENCE ONLY.)

C4494-Z02-A

PACKING LIST

OP20-46

20BH-X-9853 -0 1/1

NAME	OUTLINE	DESCRIPTION/CODE No.	QTY
KIT PARTS			
+		4X8 SUS	4
PAN HEAD P-TIGHT SCREW		000-163-797-10	
MOUNT S		20-038-1101-0	2
MOUNT S		100-406-570-10	
MOUNT S SPONGE		20-038-1102-0	1
MOUNT S SPONGE		100-406-580-10	
蝶ネット 2ヶ		MAX35 SUS304	4
WING BOLT-2		000-163-933-10	
冷間圧造蝶ネット		M4 SUS304	4
WING NUT		000-167-545-10	
図書			
フラッシュマウント型紙		E42-01512-*	1
FLUSH MOUNTING TEMPLATE		000-191-445-1*	

(略図の寸法は、参考値です。DIMENSIONS IN DRAWING FOR REFERENCE ONLY.)

C4494-Z03-A

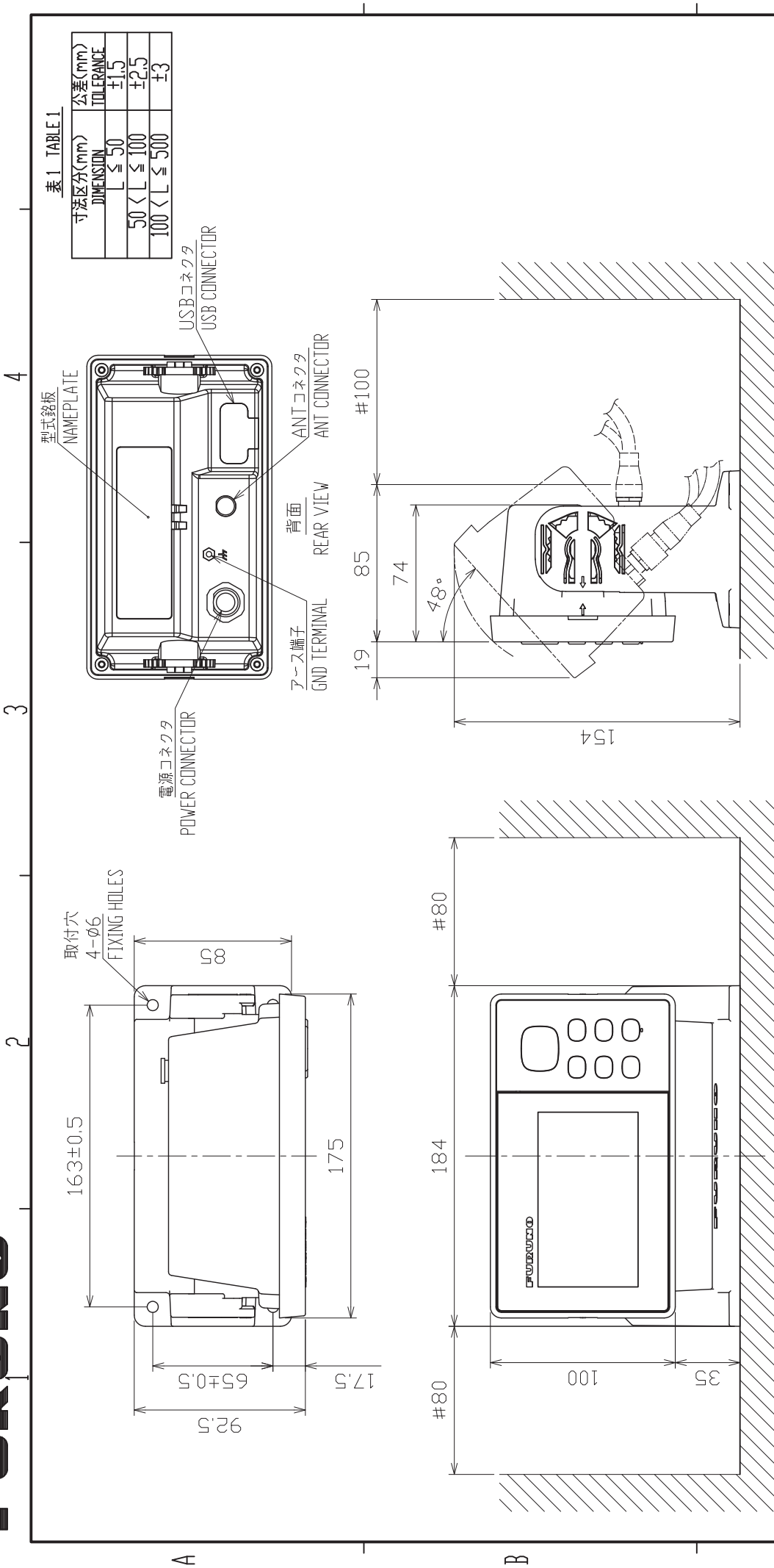

注記

- 1) 指定なき寸法公差は表 1 による。
- 2) 印寸法は最小サービス空間寸法とする。
- 3) 取付用ネジはトラスチックピンネジ呼び径5×16を使用のこと。
- 4) ケーブルはサービス時、本体を前方に十分引き出せるよう余裕を持たせること。

NOTE

1. TABLE 1 INDICATES TOLERANCE OF DIMENSIONS WHICH IS NOT SPECIFIED.
2. # MINIMUM SERVICE CLEARANCE.
3. USE TAPPING SCREWS φ5x16 FOR FIXING THE UNIT.
4. KEEP THE SUFFICIENT CABLE LENGTH FOR MAINTENANCE.

DRAWN	1/01-1/2015	I.YAMASAKI	TITLE	GP-39
CHECKED	1/01-1/2015	H.MAKI	名称	受信演算部 (卓上装備)
APPROVED	2/Oct/2015	H.MAKI	外寸図	
SCALE	1/3	質量はケーブルを含みません。 MASS DOES NOT INCLUDE CABLE.	NAME	DISPLAY UNIT (TABLETOP MOUNT)
DWG.No.	C4494-G01-A	REF.No.	20-038-100G-0	OUTLINE DRAWING

表 1 TABLE 1

寸法区分 (mm) DIMENSION	公差 (mm) TOLERANCE
$L \leq 50$	± 1.5
$50 < L \leq 100$	± 2.5
$100 < L \leq 500$	± 3

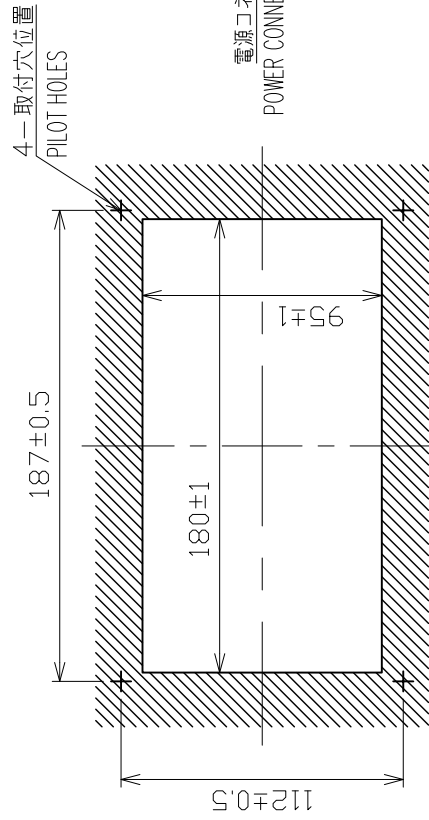
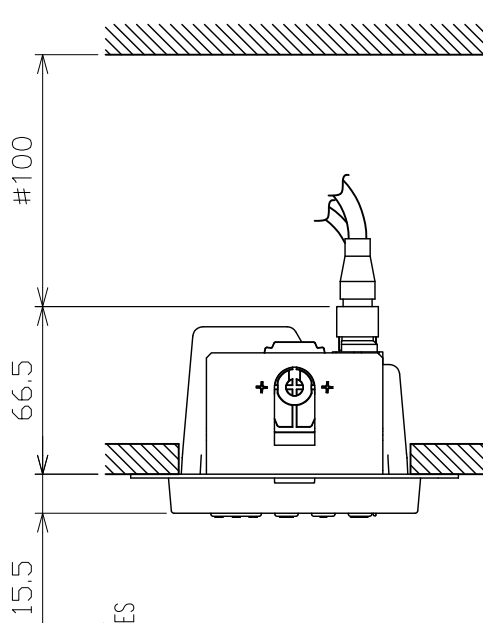

取付穴寸法
CUTOUT DIMENSIONS

注記

- 指定なき寸法公差は表 1 による。
 - 印寸法は最小サービス空間寸法とする。
 - 取付用ネジはトラスタップピンネジ呼び径5×16を使用のこと。
- NOTE
- TABLE 1 INDICATES TOLERANCE OF DIMENSIONS WHICH IS NOT SPECIFIED.
 - # MINIMUM SERVICE CLEARANCE.
 - USE TAPPING SCREWS $\phi 5 \times 16$ FOR FIXING THE UNIT.

DRAWN	1/Oct/2015	I.YAMASAKI	TITLE	GP-39
CHECKED	1/Oct/2015	H.MAKI	名称	受信演算部 (埋込装備F)
APPROVED	2/Oct/2015	H.MAKI		外寸図
SCALE	1/3	FROM MASS 0.45 kg	質量はケーブルを含みません。 MASS DOES NOT INCLUDE CABLE.	DISPLAY UNIT (FLUSH MOUNT F)
DWG.No.	C4494-G03-A	REF.No.	20-038-120G-0	OUTLINE DRAWING

表 1 TABLE 1

寸法区分 (mm)	公差 (mm)
DIMENSION	TOLERANCE
L ≤ 50	±1.5
50 < L ≤ 100	±2.5
100 < L ≤ 500	±3

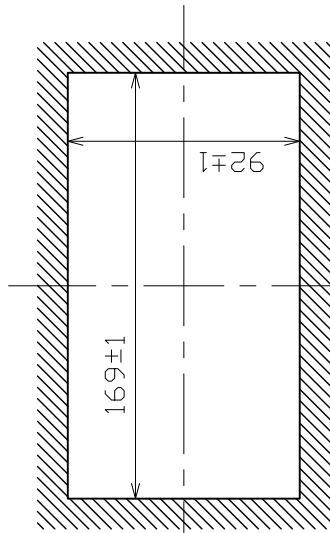
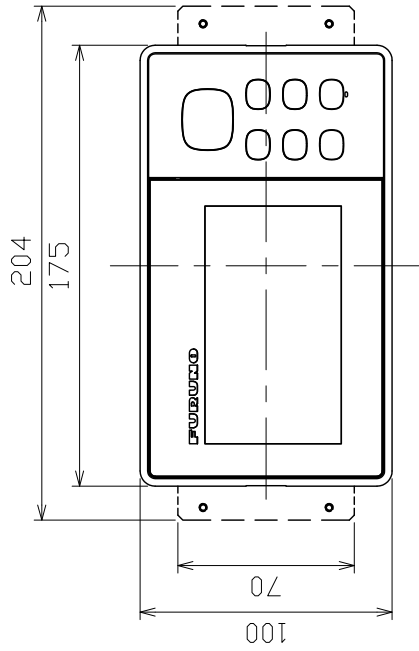
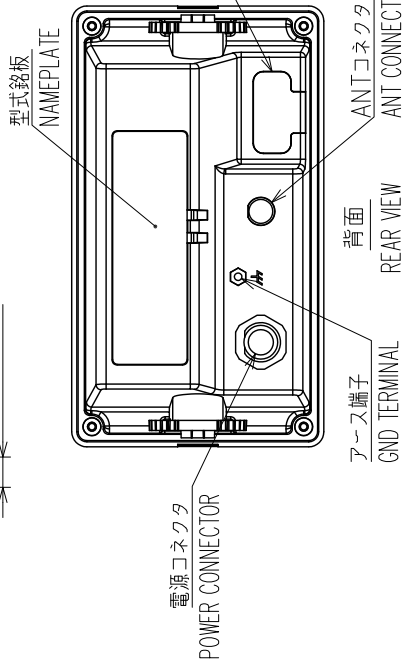
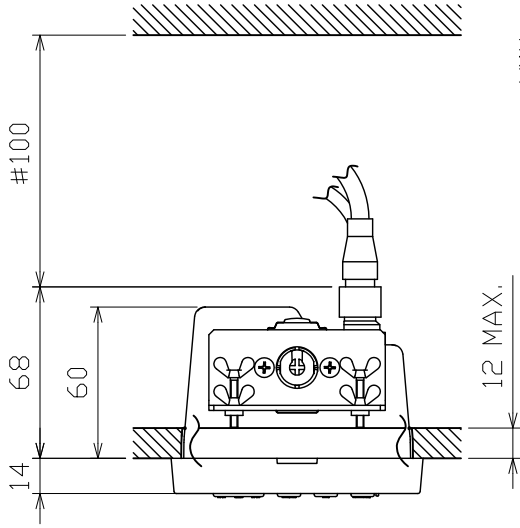

取付穴寸法
CUTOUT DIMENSIONS

注記

- 1) 指定なき寸法公差は表 1 による。
 - 2) # 印寸法は最小サービス空間寸法とする。
- NOTE
1. TABLE 1 INDICATES TOLERANCE OF DIMENSIONS WHICH IS NOT SPECIFIED.
 2. # MINIMUM SERVICE CLEARANCE.

DRAWN	1/Oct/2015	I.YAMASAKI	TITLE	GP-39
CHECKED	1/Oct/2015	H.MAKI	名称	受信演算部 (埋込装置 S)
APPROVED	2/Oct/2015	H.MAKI		外寸図
SCALE	1/3	質量はケーブルを含みません。 FROM MASS DOES NOT INCLUDE CABLE.	NAME	DISPLAY UNIT (FLUSH MOUNT S)
DWG.No.	C4494-G02-A	REF.No.	20-038-110G-0	OUTLINE DRAWING



表1 TABLE 1

寸法区分(mm) DIMENSION	公差(mm) TOLERANCE
$L \leq 50$	± 1.5
$50 < L \leq 100$	± 2.5
$100 < L \leq 500$	± 3

1-14UNS1B

ねじ山数 (25.4mmにつき) : 14
 ピッチ : 1.8143 mm
 オネジ有効長さ : 19 mm以上
 オネジ有効径 : 24.17mm

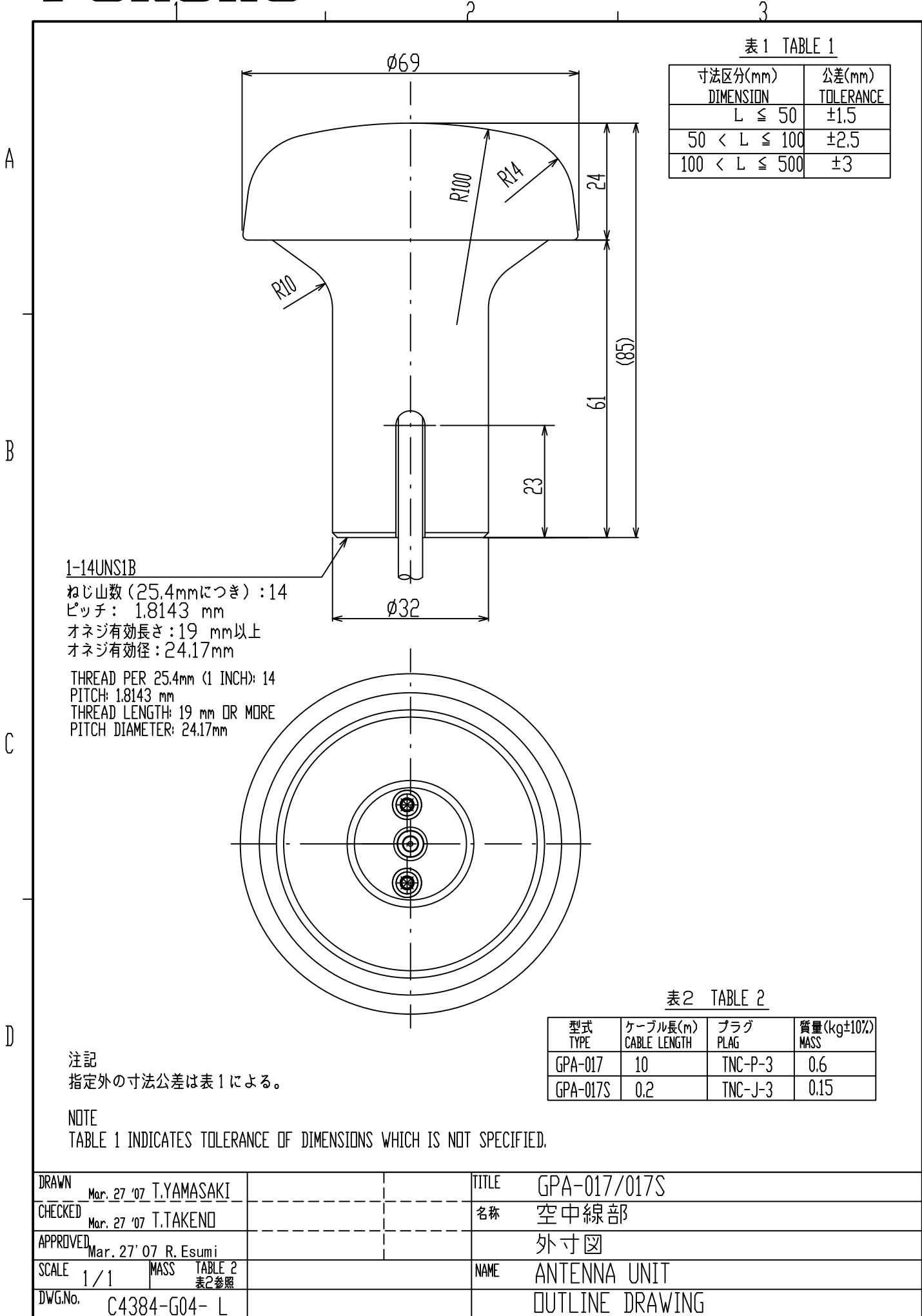
THREAD PER 25.4mm (1 INCH): 14
 PITCH: 1.8143 mm
 THREAD LENGTH: 19 mm OR MORE
 PITCH DIAMETER: 24.17mm

表2 TABLE 2

型式 TYPE	ケーブル長(m) CABLE LENGTH	プラグ PLUG	質量(kg $\pm 10\%$) MASS
GPA-017	10	TNC-P-3	0.6
GPA-017S	0.2	TNC-J-3	0.15

注記

指定外の寸法公差は表1による。

NOTE

TABLE 1 INDICATES TOLERANCE OF DIMENSIONS WHICH IS NOT SPECIFIED.

DRAWN Mar. 27 '07 T.YAMASAKI	TITLE GPA-017/017S
CHECKED Mar. 27 '07 T.TAKENO	名称 空中線部
APPROVED Mar. 27 '07 R.Esumi	外寸図
SCALE 1/1 MASS TABLE 2 表2参照	NAME ANTENNA UNIT
DWG.No. C4384-G04-L	OUTLINE DRAWING

取付位置
MOUNTING LOCATION

他の機器のアンテナから下の図の距離以上離す。
THIS FIGURE SHOWS THE SEPARATION DISTANCES FROM OTHER ANTENNAS TO AVOID MUTUAL INTERFERENCE.

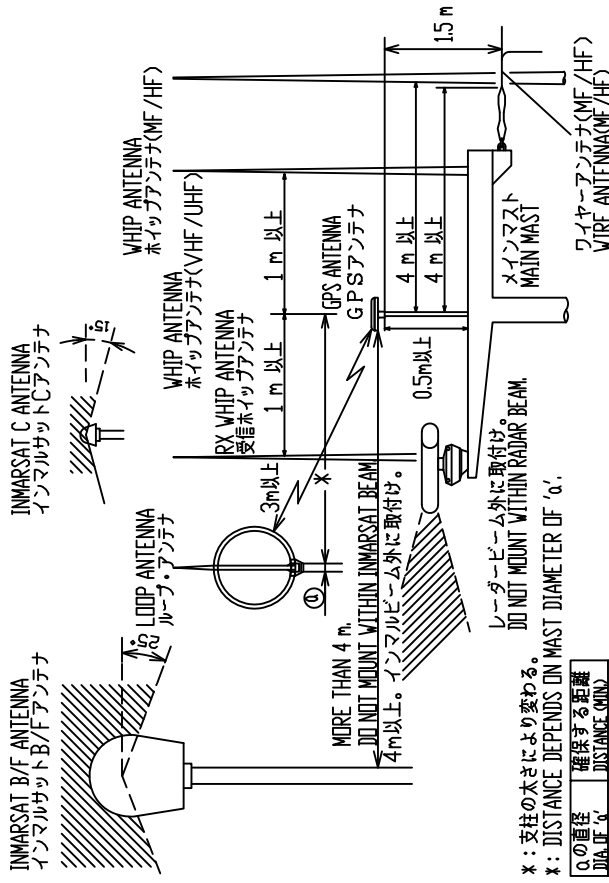

B) スタンションやパルピットにつけるとき

レール用アンテナベース No.13-RC5160
(取付可能レール直径:φ19~φ32)
(コード番号: 000-806-114)

HANDRAIL MOUNTING

USE HANDRAIL MOUNTING BASE No.13-RC5160
(CODE No.000-806-114, OPTION).
THE DIAMETER OF THE HANDRAIL MAY BE
FROM φ19mm TO φ32mm.

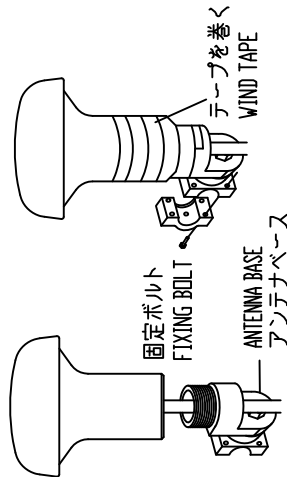

注記 1) パイプやアンテナベースはアンテナユニットにねじ込んだ後に固定する。

2) アンテナを固定するときはパイプ(アンテナベース)をアンテナにねじ込むこと。
アンテナ脚をねじるとコネクタ部やケーブルに無理がかかり、故障の原因となる。

NOTE 1. FASTEN PIPE(ANTENNA BASE) TO ANTENNA UNIT FIRST THEN FIX THEM TO MAST OR HANDRAIL.
2. WHEN FIXING ANTENNA, TURN PIPE OR ANTENNA BASE; NOT THE ANTENNA.
TURNING THE ANTENNA MAY TWIST THE CABLE AND PLACE STRESS ON CONNECTOR.

A) マストへの取付け

マスト取付金具CP20-0111(工事材料)でマストに固定する。
USE MAST MOUNTING KIT CP20-0111.

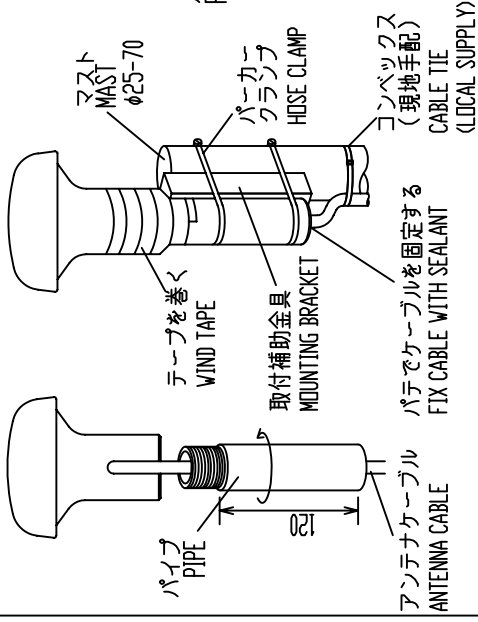

わ)パイプのみを使うとき
USE A PIPE ONLY.

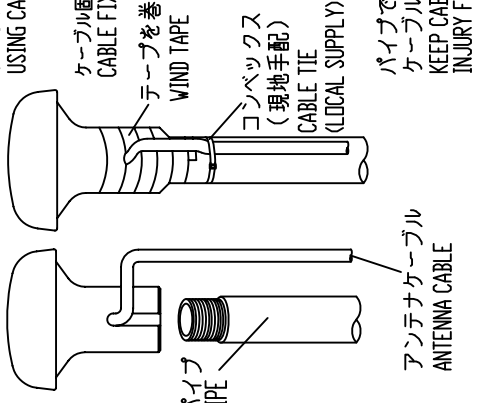

C) 取付ける場所が傾斜しているとき ANTENNA BASE MOUNTING
オプションのアンテナベースを使う。
USE OPTIONAL ANTENNA BASE.

アンテナベース基部
MOUNTING DIMENSIONS OF ANTENNA BASE.

傾斜 INCLINATION	5° - 33°	32° - 65°	65° - 98°
取付方法 MOUNTING METHOD			
アンテナ ベース型式 ANT. BASE TYPE コード番号 CODE No.	直型アンテナベース RIGHT ANGLE ANTENNA BASE No.13-QA330 000-803-239	L型アンテナベース L-TYPE ANTENNA BASE No.13-QA310 000-803-240	

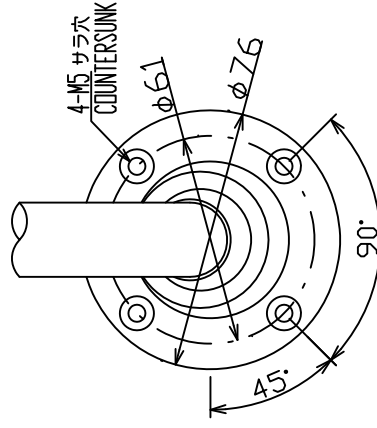

DRAWN 14/MAY/2014 T. YAMASAKI TITLE GPA series

CHECKED 14/MAY/2014 H. MAKI 名称 空中線部

APPROVED 15/May/2014 H. MAKI 装備要領図

SCALE MASS NAME ANTENNA UNIT

Drawing No. C4384-Y01-F INSTALLATION PROCEDURE

4

3

2

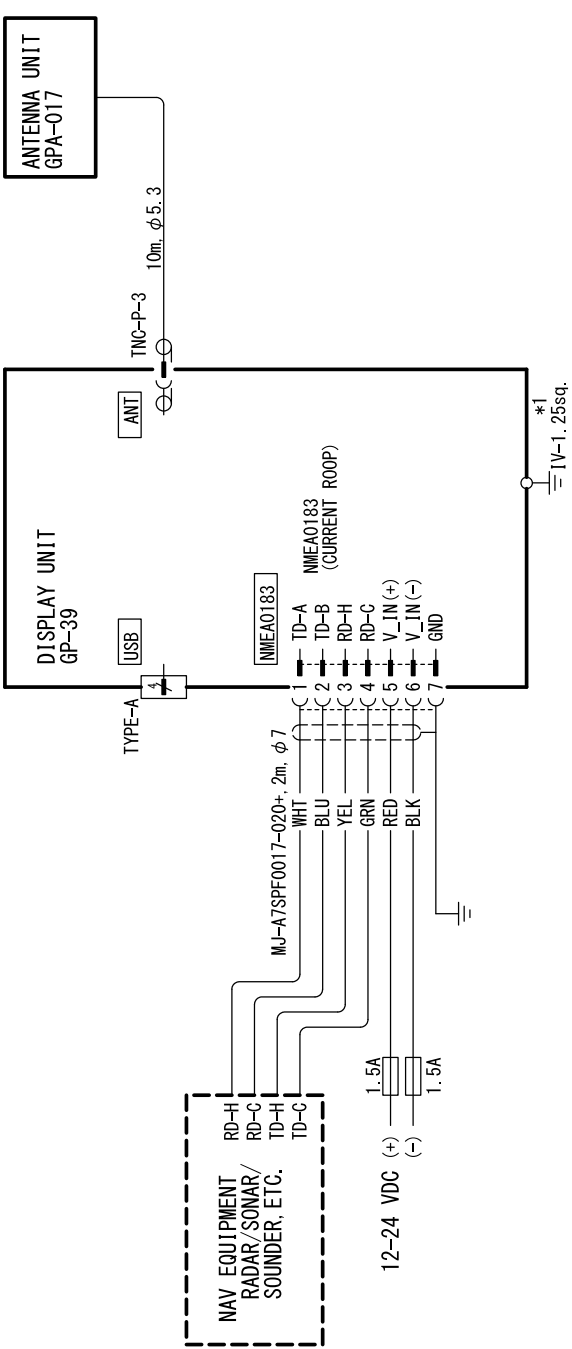

A

B

C

DRAWN	8./Jun/2016	T. YAMASAKI	TITLE	GP-39
CHECKED	8./Jun/2016	H. MAKI	NAME	GPS RECEIVER
APPROVED	9./Jun/2016	H. MAKI	INTERCONNECTION DIAGRAM	
SCALE	MASS	kg	REMARK	
DWG. No.	E4494-C01-B	REF. No.	20-038-5001-0	

NOTE
*1: SHIPYARD SUPPLY.

INDEX

A

- Alarm icon 6-1
- Alarm message 6-1
- alphanumeric data 1-9
- Anchor watch alarm 6-4
- Arrival alarm 6-4

B

- buzzer 6-2
- Buzzer type 6-2

C

- Centering own boat's position 2-2
- COG Line 7-1
- COG/BRG ref. 7-1
- Comment 3-2
- Correction Data Set 7-4
- Cursorpad 1-1

D

- Date Display 7-6
- Datum 7-2
- Daylight Saving Time 7-6
- Delete a waypoint from a route 4-3
- Demo 7-6
- diagnostic test 8-3
- Disable SV (satellite) 7-3
- DISP key 1-1
- Display 7-5
- DOP 1-2
- Downloading data from PC 7-12

E

- Edit waypoints on the plotter display 3-5
- Edit waypoints through the list 3-5
- End of sentence 7-11
- ENT/CNTR key 1-1
- Enter a waypoint at own boat position 3-1
- Enter a waypoint through the list 3-1
- Enter a waypoint with the cursor 3-1
- Enter waypoints automatically 3-3
- Erase a route through the route list 4-5
- Erase a waypoint on the plotter display
..... 3-6
- Erase a waypoint through the waypoint list
..... 3-6
- Erase all routes 4-5
- Erase all waypoints 3-7

G

- GO TO key 1-1
- Great circle 7-3

H

- Highway Display 1-5

I

- Insert a waypoint in a route 4-4

K

- Key Beep 7-5

L

- Lat Offset 7-3
- LCD brilliance 1-3
- Life of LCD 8-1
- Lon Offset 7-3
- Loran C 7-5

M

- Magnetic Variation 7-1
- MARK/MOB key 1-1
- MENU key 1-1
- MOB mark 1-10
- Mode 7-4

N

- Nav Data Display 1-6
- Navigation 7-2
- NMEA 9-6, 9-7

O

- Odometer alarm 6-5

P

- Panel brilliance 1-3
- Plotter Display 1-4

R

- Replace a waypoint in a route 4-3
- Reset (Trip) 7-6
- Rhumb line 7-3
- Route comment data format 7-11
- Route data format 7-11

S

- Satellite Monitor Display 1-7
- Set destination by cursor position 5-1
- Set destination by waypoint 5-2
- Set route as destination 5-3
- Smooth Position 7-3
- Smooth S/C (speed/course) 7-3
- Speed alarm 6-4
- Speedometer 7-9
- Steering Display 1-6
- SV ELV (satellite elevator) 7-3

T

- Temporarily deselect a waypoint in a route
..... 4-4
- Time alarm 6-5
- Time Display 7-6
- Time Offset 7-6
- Track Color 2-4
- Track Memory Used 2-3

INDEX

Trip alarm.....	6-5
TTG/ETA SPD	7-1
U	
Units.....	7-5
Uploading data to a PC.....	7-12
User Display.....	1-7
W	
WAAS alarm	6-5
WAAS Search.....	7-4
Waypoint data format.....	7-10
Waypoint Name	3-4
X	
XTE (Cross Track Error) alarm	6-4