

Thank You

Thank you for choosing MotorGuide, one of the finest trolling motors available. Years of experience have been committed to the goal of producing the finest quality products. This led to MotorGuide's reputation for strict quality control, excellence, durability, long-lasting performance and being the best at providing after-the-sale service and support.

Please read this manual carefully before operating your motor. This manual has been prepared to assist you in the operation, safe use, and care of your trolling motor.

Again, thank you for your confidence in MotorGuide.

NEVER STOP LEARNING, NEVER STOP IMPROVING, AND NEVER, EVER STOP FISHING.

Warranty Message

The product you have purchased comes with a **Two Year Limited Warranty** from MotorGuide, the terms of the policy are set forth in the **Warranty Information** section of this manual. The policy statement contains a description of the duration of coverage, **important disclaimers and limitations of damages**, and other related information. Please review this important information.

The description and specifications contained herein were in effect at the time this manual was approved for printing. Mercury Marine, whose policy is one of continued improvement, reserves the right to discontinue models at any time, to change specifications, designs, methods, or procedures without notice and without incurring obligation.

MotorGuide, Lowell, Michigan U.S.A.

Litho in U.S.A.

© 2010, MotorGuide

Mercury, Mercury Marine, MerCruiser, Mercury MerCruiser, Mercury Racing, MotorGuide, Mercury Precision Parts, Mercury Propellers, Mariner, Quicksilver, #1 On The Water, Alpha, Bravo, Bravo Two, Pro Max, OptiMax, Sport-Jet, K-Planes, MerCathode, RideGuide, SmartCraft, Total Command, VesselView, Zero Effort, Zeus, M with Waves logo, Mercury with Waves logo, and SmartCraft logo are all registered trademarks of Brunswick Corporation. Mercury Product Protection logo is a registered service mark of Brunswick Corporation.

General Information

MotorGuide Limited Warranty.....	1
General Information.....	4
Recording Serial Number.....	5
Boater's Responsibilities.....	6
Passenger Safety Message.....	6
Safe Boating Suggestions.....	7
Component Identification.....	8
Extending and Retracting the Handle.....	10
Installing the Propeller.....	11

Wiring and Battery

Battery Precautions.....	12
Standard Practices and Procedures.....	12
Battery Recommendations.....	12
Wire Color Code Abbreviations.....	13
Wire and Cable Routing.....	13

Mount Installation

Transom Mount Installation.....	18
Pontoon Mount Installation.....	18
Bow Mount Installation.....	18

Bow Mount Operation

Installing the Motor into the Mount.....	21
Removing the Motor from the Mount.....	21
Raising and Lowering the Trolling Motor.....	22
Adjusting the Steering Tension (Hand Operated Motors).....	23
Adjusting the Motor Depth.....	24

Trolling Motor Operation

Directional Indicator.....	26
Speed Control.....	27
Constant/Momentary/High-Bypass.....	27
Twist Tiller Speed Control.....	28
Permanent Foot Pedal Mounting.....	28

Maintenance

Trolling Motor Care.....	30
Inspection and Maintenance Schedule.....	30
Storage Preparation.....	31
Battery Inspection.....	32
Propeller Replacement.....	32
Great White Saltwater Models Only.....	33

Owner Service Assistance

Troubleshooting.....	34
Service Assistance.....	36
Mercury Marine Service Offices.....	36

GENERAL INFORMATION

MotorGuide Limited Warranty

KEEP YOUR ORIGINAL PURCHASE RECEIPT OR BILL OF SALE.

1. For recreational use customers, MotorGuide electric trolling motors are warranted to the original retail purchaser to be free from defects in material or workmanship for two (2) years.
2. To obtain warranty service, the purchaser should deliver or return the unit (postage prepaid and insured) to any authorized MotorGuide service dealer. **DO NOT RETURN TO PLACE OF PURCHASE** unless they are an authorized service center. Products returned by mail should be carefully packaged and include a note describing the nature of the problem and/or service requested, customer address, and phone number. A copy of the receipt, Bill of Sale, registration verification, or other proof of purchase is required with the return of the product for warranty consideration. Warranty claims will not be accepted without presentation of purchase receipt for trolling motor, other verification of registration, or Bill of Sale for boat package.
3. MotorGuide, at its discretion, will repair or replace items covered under the terms of this warranty. Neither MotorGuide nor MotorGuide service dealers are responsible for damages to MotorGuide products due to repairs performed by anyone other than an authorized MotorGuide service dealer. Neither MotorGuide nor Mercury Marine is responsible for failure or damage caused by improper installation, setup, preparation, or previous service or repair errors.
4. For commercial use and government use customers, MotorGuide electric trolling motors are warranted to the original retail purchaser to be free from defects in material or workmanship for one (1) year. Commercial use is defined as any work or employment-related use of the product, or any use of the product which generates income, for any part of the warranty period, even if the product is only occasionally used for such purpose such as Rental Fleets, Guides, Fish Camps, or similar operations. Warranty is not transferable to any subsequent purchaser. The Mercury Product Protection plan is not available to commercial use or government use customers.

GENERAL INFORMATION

5. Warranty coverage is available to customers that purchase from an authorized dealer or retailer that is authorized by MotorGuide Marine to distribute the product in the country in which the sale occurred. Warranty coverage and duration varies by the country in which the owner resides. This warranty applies to MotorGuide trolling motors sold and used in the United States. This Limited Warranty begins on the date the product is first sold to a purchaser or the date on which the product is first put into service, whichever occurs first. MotorGuide accessories are covered by this Limited Warranty for a coverage period of one (1) year from the date of retail sale. The repair or replacement of parts, or the performance of service under this warranty, does not extend the life of this warranty beyond its original expiration date. Promotional warranties are not included in this statement and coverage may vary by promotion. Product either sold or put into service more than six years from date of manufacture is excluded from warranty coverage.
6. This warranty does not apply to normal worn parts, for example, worn cables, adjustments, or product damage due to; 1) neglect, lack of maintenance, accident, abnormal operation, or improper installation or service; 2) abuse, such as, bent metal columns, bent armature shafts, broken control cables, etc., accidents, modifications, misuse, excessive wear or damage caused by an owner's failure to provide reasonable and necessary installation or care; 3) use of an accessory or part not manufactured by MotorGuide or Mercury; 4) alteration or removal of parts; 5) opening the lower unit (motor) by anyone other than an authorized MotorGuide service center will void this warranty.
7. We reserve the right to improve the design of any trolling motor without assuming any obligation to modify any trolling motor previously manufactured.

GENERAL INFORMATION

8. All serialized "Service-Repair" trolling motors receive a one (1) year warranty. Nonserialized "Service-Repair" electric trolling motors are NOT warranted. "Service-Repair" motor denotes a trolling motor sold by MotorGuide that may be used, but has been inspected and may have had minor repairs. Original retail purchaser of a "Service-Repair" motor is the first purchaser of the motor after it is denoted as "Service-Repair." "Service-Repair" motors have a blue sticker on the battery cable and box denoting "Manufacturer Certified Service-Repair Motor."
9. This warranty will not apply to 1) haul-out, launch, towing and storage, transportation charges and/or travel time, telephone or rental charges of any type, inconvenience, or loss of time or income, or other consequential damages; or 2) removal or replacement of boat partitions or material because of boat design for necessary access to the Product; or 3) disconnection and reconnection of hard-wired trolling motors.
10. TERMINATION OF COVERAGE: Warranty coverage may be terminated for repossessed product, or product purchased at auction, from a salvage yard, from a liquidator, from an insurance company, from unauthorized marine dealers or boatbuilders, or other third party entities.
11. ALL INCIDENTAL OR CONSEQUENTIAL DAMAGES ARE EXCLUDED FROM THIS WARRANTY, WARRANTIES OF MERCHANTABILITY AND FITNESS ARE EXCLUDED FROM THIS WARRANTY, IMPLIED WARRANTIES ARE LIMITED TO THE LIFE OF THIS WARRANTY. SOME STATES DO NOT ALLOW LIMITATIONS ON HOW LONG AN IMPLIED WARRANTY LASTS OR THE EXCLUSION OR LIMITATION OF INCIDENTAL OR CONSEQUENTIAL DAMAGES, SO THE ABOVE LIMITATIONS OR EXCLUSIONS MAY NOT APPLY TO YOU. THIS WARRANTY GIVES YOU SPECIFIC LEGAL RIGHTS, AND YOU MAY ALSO HAVE OTHER LEGAL RIGHTS WHICH MAY VARY FROM STATE TO STATE.

For your records:

Model Number _____

Serial Number _____

GENERAL INFORMATION

General Information

Please read and retain this manual. The information within describes the proper procedures for safely installing, operating, and maintaining your motor.

The description and specifications contained herein were in effect at the time this manual was approved for printing. MotorGuide, whose policy is one of continual improvement, reserves the right to discontinue models at any time, to change specifications, designs, and methods of procedure without notice and without incurring obligation.

Safety and operating information that is practiced along with good common sense can help prevent personal injury and product damage.

SAFETY DO'S AND DON'TS

Do not allow children to operate the trolling motor without adult supervision.

Do not modify the unit in any way or add accessories other than approved MotorGuide accessories.

Do not power-wash your trolling motor.

Do disconnect the power from the motor when replacing the propeller, removing debris around the propeller, charging batteries, putting your boat on a trailer, or when the motor is not in use.

Do verify the foot pedal is secured and the motor is securely locked into the stowed position when using a gasoline motor to move to another location, or when putting your boat on a trailer.

Do secure loose items on your boat before traveling at high speeds across the water.

HOW TO USE THIS MANUAL

Review the following information carefully. These notices will alert you to potential dangers and important information.

The observance of WARNINGS and CAUTIONS alone does not eliminate the possibility of personal injury or product damage. Your close attention to the performance of recommended service procedures and the practice of responsible personal safety are major accident prevention measures.

GENERAL INFORMATION

WARNING

Failure to follow a safety WARNING can result in bodily injury.

Recording Serial Number

Record the serial number for future reference. For warranty purposes, complete the enclosed warranty card or register your trolling motor at www.motorguide.com.

TRANSOM MOUNT FOOT CONTROL MODEL

The transom mount serial number decal is located underneath the bottom cover.

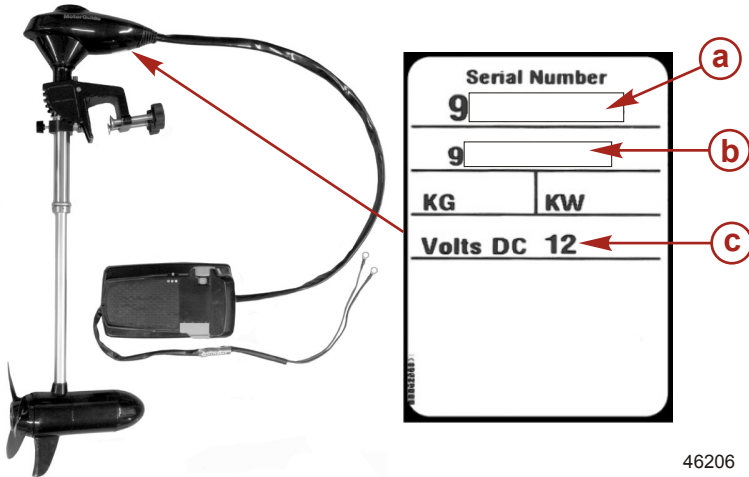

46206

- a** - Serial number
- b** - Model identification number
- c** - Voltage

GENERAL INFORMATION

BOW MOUNT HAND CONTROL MODEL

The bow mount serial number decal is located underneath the bottom cover.

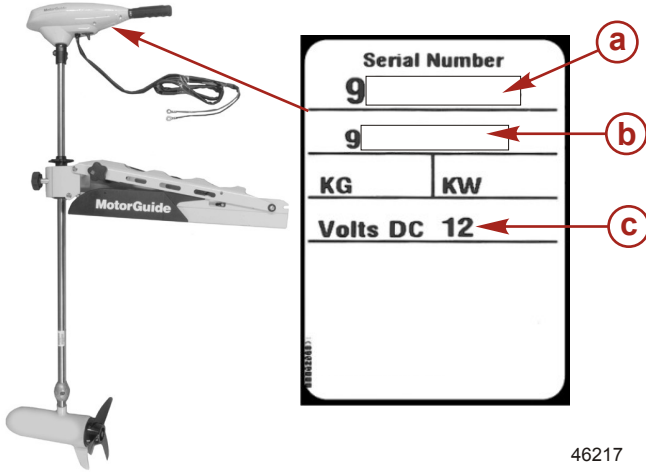

46217

- a** - Serial number
- b** - Model identification number
- c** - Voltage

Boater's Responsibilities

The operator (driver) is responsible for the correct and safe operation of the boat and safety of its occupants and general public. It is strongly recommended that each operator (driver) read and understand this entire manual before operating the trolling motor.

Be sure at least one additional person on board is instructed in the basic operation of the trolling motor in case the driver is unable to operate the boat.

Passenger Safety Message

Whenever the boat is in motion, observe the location of all passengers. A sudden reduction in boat speed, such as a sharp change of boat direction, could throw them off the boat.

GENERAL INFORMATION

Safe Boating Suggestions

In order to safely enjoy the waterways, familiarize yourself with local and other governmental boating regulations and restrictions, and consider the following suggestions.

Use flotation devices. It is the law to have an approved personal flotation device of suitable size for each person aboard and have it readily accessible.

Do not overload your boat. Most boats are rated and certified for maximum load (weight) capacities, refer to your boat capacity plate. If in doubt, contact your dealer or the boat's manufacturer.

Perform safety checks and required maintenance. Follow a regular schedule and ensure all repairs are made properly.

Never be under the influence of alcohol or drugs while boating (it is the law). Alcohol or drug use impairs your judgment and greatly reduces your ability to react quickly.

Passenger boarding. Stop the trolling motor whenever passengers are boarding or unloading.

Be alert. The operator of the boat is responsible by law to maintain a proper lookout by sight and hearing. The operator must have an unobstructed view particularly to the front. No passengers, load, or fishing seats should block the operators view when operating the boat.

Underwater hazards. Reduce speed and proceed with caution whenever navigating in shallow water.

Tripping hazards. To avoid a trip hazard, route all cables and wiring neatly and out of the way.

Report accidents. Boat operators are required by law to file a Boating Accident Report with their state boating law enforcement agency when their boat is involved in certain boating accidents. A boating accident must be reported if 1) there is loss of life or probable loss of life, 2) there is personal injury requiring medical treatment beyond first aid, 3) there is damage to boats or other property where the damage value exceeds \$500.00 or 4) there is complete loss of the boat. Seek further assistance from local law enforcement.

GENERAL INFORMATION

Component Identification

TRANSOM MOUNT FOOT CONTROL

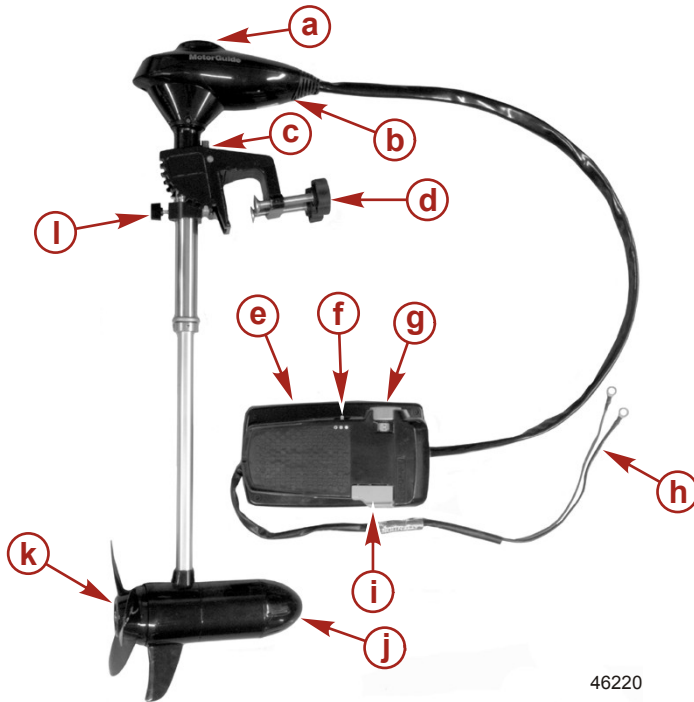

46220

- a** - Directional indicator
- b** - Serial number decal
- c** - Tilt latch
- d** - Clamp bracket (Bulldog model)
- e** - Foot pedal
- f** - Three-position switch
- g** - Speed control
- h** - Battery cables
- i** - Momentary switch
- j** - Lower unit
- k** - Propeller
- l** - Steering tension knob

GENERAL INFORMATION

BOW MOUNT HAND CONTROL

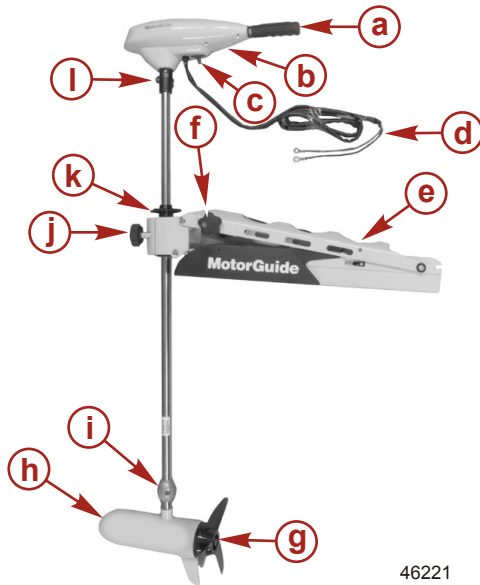

- a** - Extendable speed control handle
- b** - Serial number decal
- c** - On/off switch
- d** - Battery cables
- e** - Mount
- f** - Breakaway adjustment knob
- g** - Propeller
- h** - Lower unit
- i** - Anode
- j** - Bracket door knob
- k** - Steering tension knob
- l** - Depth adjustment collar

46221

BOW MOUNT FOOT CONTROL

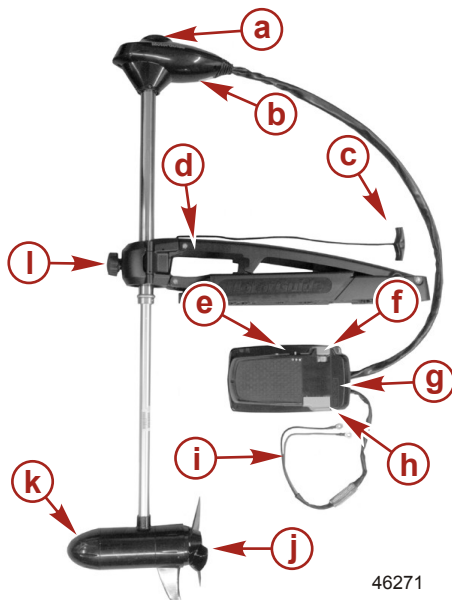

- a** - Directional indicator
- b** - Serial number decal
- c** - Lockslide release handle
- d** - Mount
- e** - Three-position switch
- f** - Speed control
- g** - Foot pedal
- h** - Momentary switch
- i** - Battery cables
- j** - Propeller
- k** - Lower unit
- l** - Bracket door knob

46271

GENERAL INFORMATION

Extending and Retracting the Handle

1. Speed and direction control are provided through the tiller handle on the bow mount and transom mount hand control models.



a - Tiller handle

46265

2. Extend or retract the handle to the desired length.

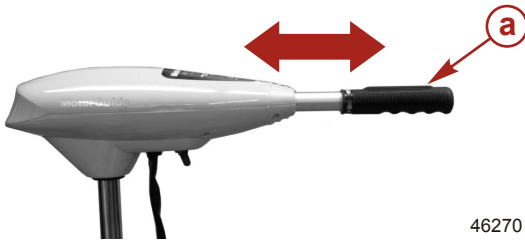

a - Speed and directional control handle

46270

GENERAL INFORMATION

Installing the Propeller

WARNING

Performing service or maintenance without first disconnecting the battery can cause product damage, personal injury, or death due to fire, explosion, electrical shock, or unexpected motor starting. Always disconnect the battery cables from the battery before maintaining, servicing, installing, or removing motor components.

1. Rotate the motor shaft to insert the propeller pin horizontally.

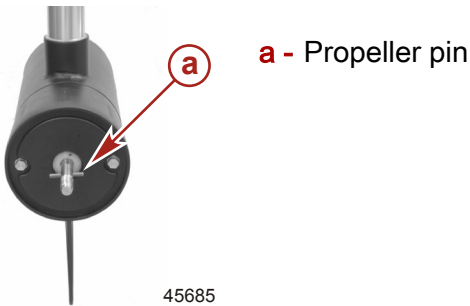

2. Install the propeller onto the motor shaft by engaging the propeller onto the propeller pin.
3. Install the propeller nut. Tighten securely.

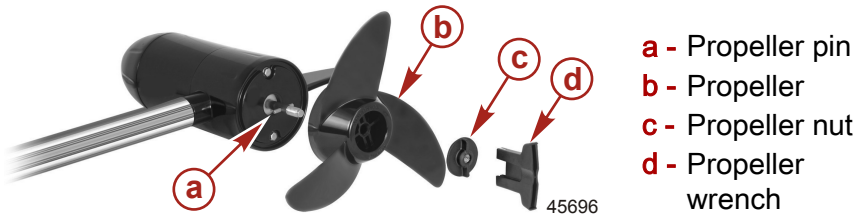

4. Use a MotorGuide propeller wrench or pliers to tighten the propeller nut another $\frac{1}{4}$ turn.

Recommended MotorGuide Accessory Description	Part Number
MotorGuide prop wrench kit	MGA050B6

WIRING AND BATTERY

Battery Precautions

WARNING

An operating or charging battery produces gas that can ignite and explode, spraying out sulfuric acid, which can cause severe burns. Ventilate the area around the battery and wear protective equipment when handling or servicing batteries.

When charging batteries, an explosive gas mixture forms in each cell. Part of this gas escapes through holes in the vent plugs and may form an explosive atmosphere around the battery if ventilation is poor. This explosive gas may remain in or around the battery for several hours after it has been charged. Sparks or flames can ignite this gas and cause an internal explosion, which may shatter the battery.

The following precautions should be observed to prevent an explosion:

1. Do not smoke near batteries being charged or which have been charged very recently.
2. Do not break live circuits at terminals of batteries, because a spark usually occurs at the point where a live circuit is broken. Always be careful when connecting or disconnecting cable clamps on chargers. Poor connections are a common cause of electrical arcs which cause explosions.
3. Do not reverse polarity of battery terminal to cable connections.

Standard Practices and Procedures

- Do not use the main engine battery to power the trolling motor.
- Disconnect the trolling motor from the battery when charging and after each use.
- Route the trolling motor wires on the opposite side of the boat from other miscellaneous boat wiring.
- Connect boat accessories directly to the main engine battery.

Battery Recommendations

- Use a 12 volt, deep cycle marine battery.
- Install a 50 amp manual reset circuit breaker in line with the trolling motor positive leads within 180 cm (72 in.) of the batteries.

WIRING AND BATTERY

- Use 13 mm (6 gauge) battery cables if extending the existing wire beyond the standard battery cable.

Recommended MotorGuide Accessory Description	Part Number
Trolling motor power plug	8M4000953
Trolling motor sp (receptacle)	8M4000954
50 amp alligator clips	8M4000287
6 gauge battery cable and terminals with 50 amp manual reset circuit breaker	MM309922T
50 amp manual reset circuit breaker	MM5870

Wire Color Code Abbreviations

Wire Color Abbreviations			
BLK	Black	BLU	Blue
BRN	Brown	GRY	Gray
GRN	Green	ORN or ORG	Orange
PNK	Pink	PPL or PUR	Purple
RED	Red	TAN	Tan
WHT	White	YEL	Yellow
LT or LIT	Light	DK or DRK	Dark

Wire and Cable Routing

Route trolling motor wires on the opposite side of the boat from other miscellaneous boat wiring (bow light wiring, spot light wiring, etc.).

Transducer installation should be installed according to the manufacturer's specifications. To avoid interference, cables should be routed separately from the trolling motor power cables.

IMPORTANT: Do not route the transducer cable down the trolling motor power cord or foot pedal assembly cable. Route the transducer cable down the arm of the mount, then into the bow console.

Sensitive electronics, depth finders in particular, should be connected directly to the main engine battery. If only a one battery system is used, then connect with separate cables.

WIRING AND BATTERY

ESTABLISHING A COMMON GROUND

MotorGuide recommends isolating the trolling motor battery/batteries from the main engine battery.

Electrolysis issues: Using the engine starting battery as a source of power for any trolling motor may cause electrolysis on metallic parts.

- If you have followed the battery wiring and installation instructions in this manual and your boat continues to have electrolysis issues, you will need to separate the trolling motor from any other boat electronics.
- Remove the engine starting battery from the wiring configuration of the boat and isolate the power circuit for your trolling motor.

Establish a common ground: Common ground means the ground for the main engine accessories and your trolling motor are connected to the same negative ground terminal.

- Not having a common ground can cause severe corrosion or electrolysis. If left unchecked, damage may be caused to your trolling motor and boat.
- Establishing a common ground connection will allow increased sensitivity and improve detail on a sonar display.

RECOMMENDATIONS

Battery type: The recommended battery is a 12 volt deep cycle battery.

Circuit protection: MotorGuide recommends installing a 50 amp manual reset circuit breaker in line with the trolling motor positive leads within 180 cm (72 in.) of the batteries. To order a circuit breaker kit, contact your local service dealer, request kit number **MM5870**.

Wire size: For optimum performance, MotorGuide recommends the use of 13 mm (6 gauge) wire if extending the existing wire beyond the standard battery cable supplied with the product.

Bow plugs: For temporary trolling motor installations, MotorGuide recommends the use of a quality plug designed for marine applications.

WIRING AND BATTERY

Connect the red battery lead to the battery positive (+) post and the black battery lead to the battery negative (-) post. Install a 50 amp circuit breaker in line with the positive lead, as shown.

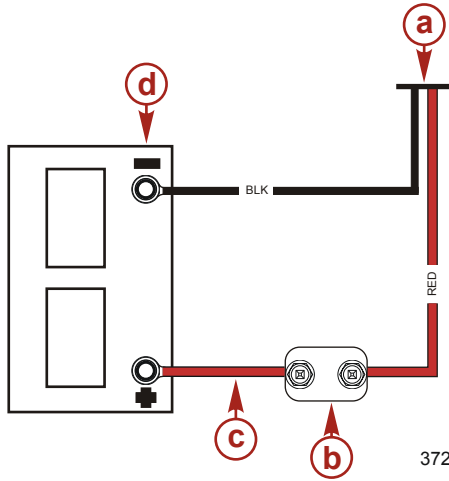

12 volt battery hookup

- a** - Power cable
- b** - 50 amp manual reset circuit breaker
- c** - Jumper wire
- d** - Common ground

37289

WIRING AND BATTERY

Connect the black battery lead from the power cable to the negative (-) post on battery A and the red lead to the positive (+) post on battery B. Connect a jumper wire between the negative (-) post of battery B and the positive (+) post of battery A. Install a 50 amp circuit breaker in line with the positive lead to battery B, as shown.

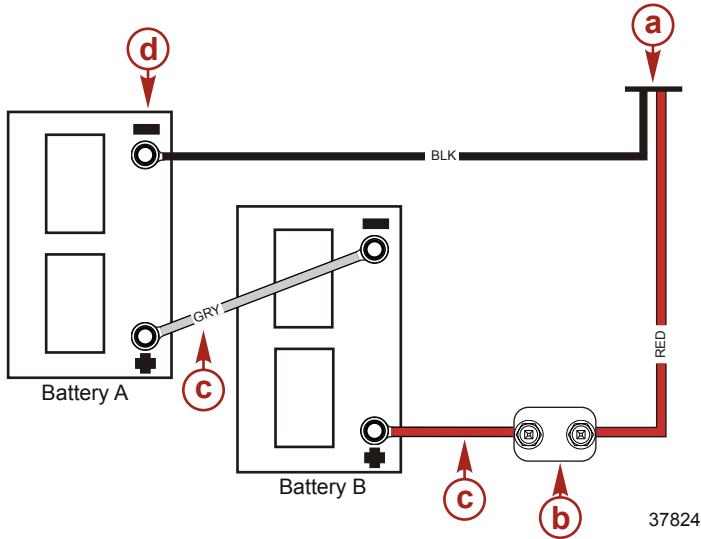

24 volt battery hookup

- a** - Power cable
- b** - 50 amp manual reset circuit breaker
- c** - Jumper wire
- d** - Common ground

WIRING AND BATTERY

Connect the black battery lead from the power cable to the negative (-) post on battery A. Connect the red battery lead from the power cable to the positive (+) post of battery C. Connect a jumper wire between the positive (+) post of battery A to the negative (-) post of battery B. Connect another jumper wire between the positive (+) post of battery B to the negative (-) post of battery C. Install a 50 amp circuit breaker in line with the positive battery lead.

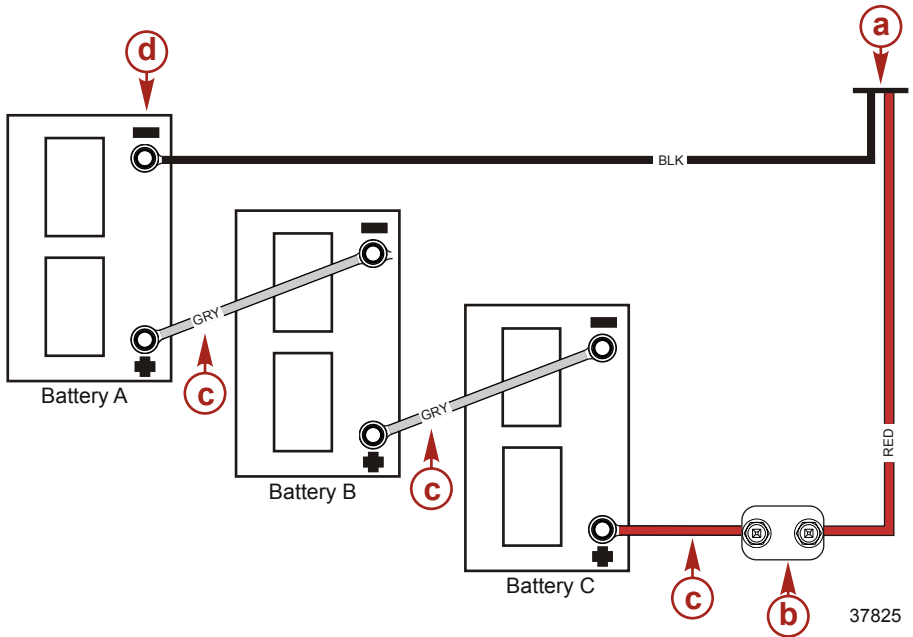

36 volt battery hookup

- a** - Power cable
- b** - 50 amp manual reset circuit breaker
- c** - Jumper wire
- d** - Common ground

MOUNT INSTALLATION

Transom Mount Installation

TWIST TILLER MODELS

1. **Clamp screws:** The clamp screws allow for easy motor installation and removal. Mount your motor on the transom and then tighten the clamp screws securely.
2. **Tilt position pin:** This pin allows you to adjust the tilt of the motor.
3. **Depth collar adjustment:** The depth of the motor can be adjusted up and down by loosening the depth collar knob. The depth collar is located on the column directly above the mount. After adjusting to the position and depth desired, tighten the knob.
4. **Steering tension adjustment:** To adjust the steering resistance, simply tighten or loosen the steering friction knob.

Pontoon Mount Installation

1. Carefully select the area on the deck to install the mount. Choose an area where the mount will provide ample clearance for all of the motor positions, including the running and stowing positions.
2. Place the mount base on the surface of the boat deck where it is to be mounted; use the mount base as a template to mark the location of the holes.
3. Drill mounting holes with a 6.5 mm (0.25 in.) drill bit and clear the holes of any debris. Countersink the holes (only on fiberglass boats) and again clear any remaining debris from the holes.
4. Install the four stainless steel mounting bolts through each of the bracket mounting holes.
5. Install the four stainless steel washers and nuts on the bottom side of the deck and tighten securely.
6. The trolling motor can now be placed in the mount.

Bow Mount Installation

IMPORTANT: Choose an area on the deck that provides 7.6 cm (3 in.) clearance from the bow of the boat for all motor positions, including deployed and stowed positions.

MOUNT INSTALLATION

1. Select an appropriate area on the deck of the boat to install the mount. Ensure the forward mounting screws will not penetrate the hull.

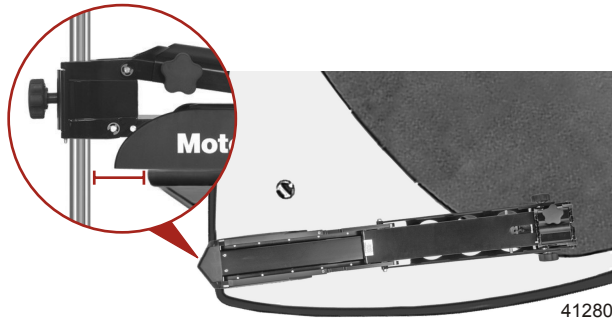

Mount on deck with a 7.6 cm (3 in.) clearance

2. Using a Phillips head screwdriver and the decket screws provided in the hardware bag, secure the decket to the mount base. (The decket for heavy duty spring mounts can be installed last.)
3. Use the bow mount base as a template to mark the location of the front mounting holes in the plastic decket and the rear mounting holes on the mount base.

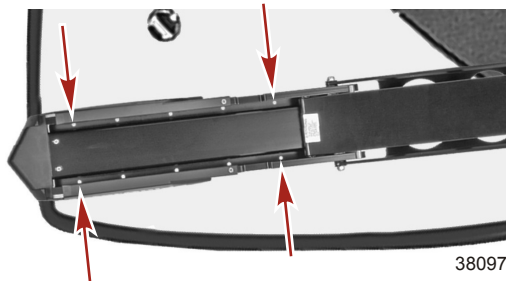

4. Drill the mounting holes with a 6.5 mm (0.25 in.) diameter drill bit. Remove any debris.

MOUNT INSTALLATION

5. If using rubber mounting isolators, drill each mounting hole with a 13 mm (0.5 in.) diameter drill bit.



NOTE: A rubber spacer or washer should be used between the base of the mount and the boat mounting surface when the rubber isolators are not used.

6. Insert the rubber mounting isolators into the drilled holes. Position the wider side of the isolator toward the outside of the mount bracket.
7. Place the mount bracket on the isolators and align the holes. Install the two longer screws into the front holes and the two shorter screws into the rear holes. Tighten all of the mounting screws with a Phillips screwdriver. Do not tighten the mounting screws with an electric screwdriver.

NOTE: It is important that the bracket lies even against the isolators before bolting it to the deck. If the mount is not even, it will bind as it is bolted down making it difficult or impossible to unlatch. Once installed, the latch pins should snap firmly into place and release easily with a quick snap of the wrist and a light pull of the rope handle.

8. When the bracket is installed, it should fasten securely and evenly with the latch pins and release with a light, quick, pull of the rope handle.

BOW MOUNT OPERATION

Installing the Motor into the Mount

1. Turn the bracket door knob counterclockwise and open the bracket door.
2. Place the motor column into the bracket and close the door.
3. Turn the bracket door knob clockwise to tighten the motor column in the bracket.

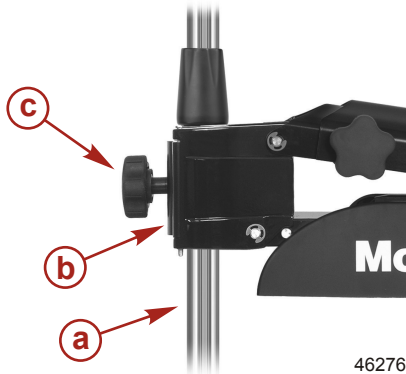

- a - Motor column
- b - Bracket door
- c - Bracket door knob

Removing the Motor from the Mount

1. Turn the bracket door knob counterclockwise to loosen and open the bracket door.
2. Remove the motor column from the bracket and close the door.

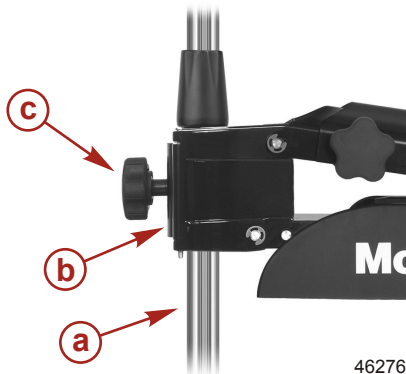

- a - Motor column
- b - Bracket door
- c - Bracket door knob

BOW MOUNT OPERATION

Raising and Lowering the Trolling Motor

⚠ WARNING

Rotating propellers can cause serious injury or death. Never start or operate the motor out of water.

⚠ CAUTION

Moving parts, such as hinges and pivot points, can cause serious injury. Keep away from moving parts when stowing, deploying, or tilting the motor.

RAISING THE MOTOR

1. Raise the motor by pulling on the mount rope handle. Do not let the weight of the motor cause it to drop.



41443

Mount rope

2. Pull the rope handle until the motor can be laid across the mount into the stow position.

BOW MOUNT OPERATION

3. Apply pressure by pushing down on the top housing and the shaft to lock the motor into the stow position.

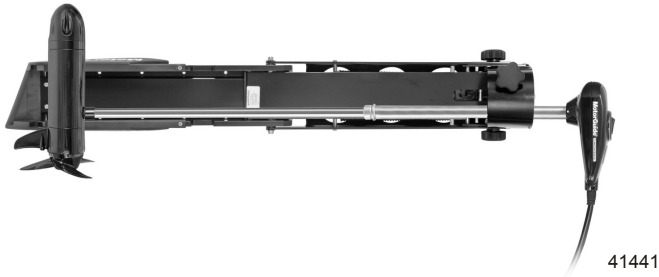

Motor in the stowed position

LOWERING THE MOTOR

1. Pull the rope handle to lift the motor up.
2. Do not let the weight of the motor cause it to drop.
3. Gently lower the motor into the water.

Adjusting the Steering Tension (Hand Operated Motors)

Loosen the steering tension knob until the motor column turns around freely. Tighten the steering tension knob to secure the motor column in place.

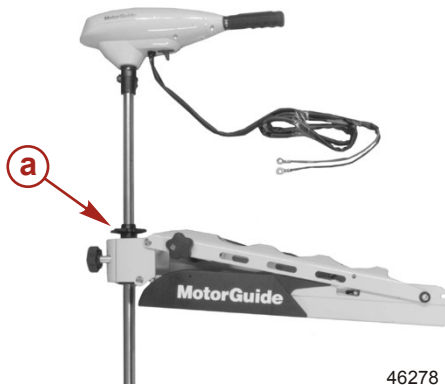

a - Steering tension knob

BOW MOUNT OPERATION

Adjusting the Motor Depth

Hand operated motors: Loosen the depth adjustment collar so the motor column moves freely up and down. Raise or lower the motor column until the propeller blades are submerged 15–30 cm (6–12 in.) below the water surface and tighten the collar.



- a** - Depth adjustment collar
- b** - Breakaway knob

IMPORTANT: Adjust the breakaway knobs on the side of the mount so the motor will breakaway when encountering underwater obstacles. Do not overtighten or lubricate the breakaway knob.

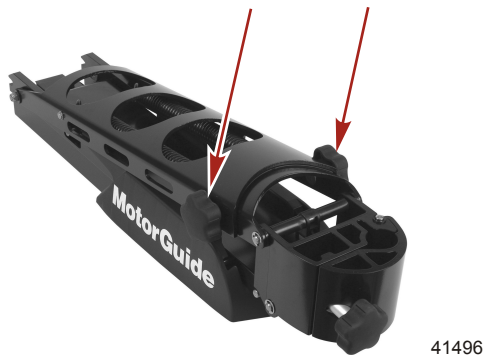

BOW MOUNT OPERATION

Foot operated motors: Loosen the bracket door knob so the column moves freely up and down. Raise or lower the motor column until the propeller blades are submerged 15–30 cm (6–12 in.) below the water surface and tighten the door.

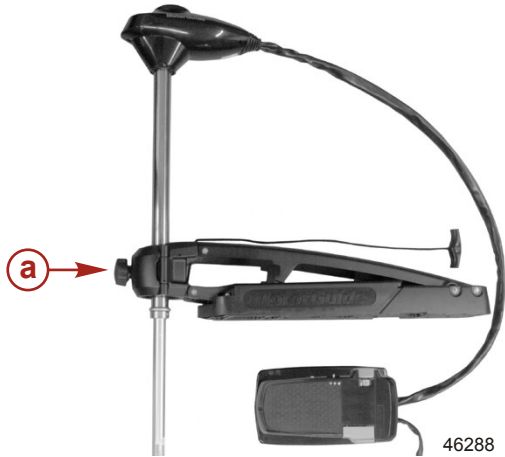

a - Bracket door knob

46288

TROLLING MOTOR OPERATION

Directional Indicator

The indicator provides directional information at a glance.

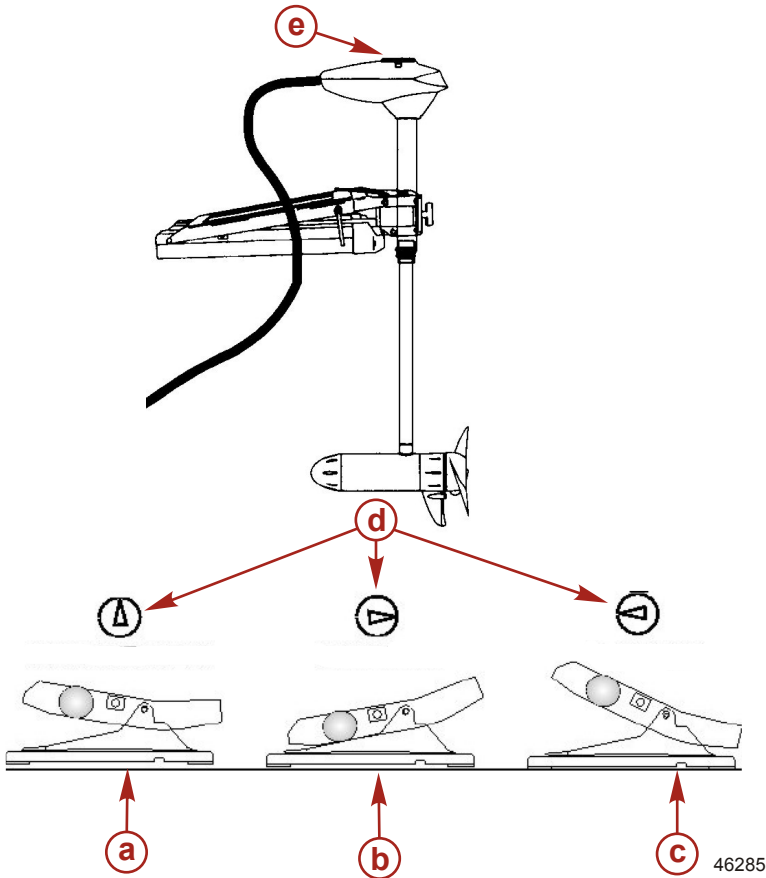

- a** - Straight ahead - foot pedal in middle
- b** - Right turn - toe down; motor steers boat to right (continue to push all the way down for reverse)
- c** - Left turn - heel down; motor steers boat to left (continue to press all the way down for reverse)
- d** - Directional indicator arrows
- e** - Directional indicator

TROLLING MOTOR OPERATION

Speed Control

FIVE-SPEED AND VARIABLE SPEED MOTORS

Foot operated motors are either five-speed or variable speed models. Control the speed of your motor by rolling the speed control knob with your hand or foot until you reach the desired speed.

- **Five-speed motor:** The speed control knob on a five-speed motor is numbered 1–5 and allows you to select one of five preset speeds.
- **Variable speed motor:** The speed control knob on a variable speed motor allows you the capability of variable speed selections from off to high.

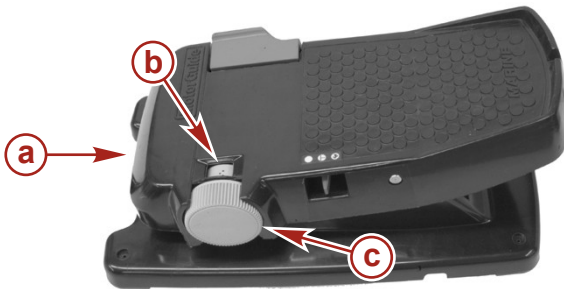

46289

- a** - Foot pedal
- b** - Speed select window (1–5)
- c** - Speed control knob

Constant/Momentary/High-Bypass

Momentary switch: The momentary switch is located on the top right side of the foot pedal. The momentary switch works in conjunction with the three-position switch when it is in momentary or high-bypass position.

Three-position switch: This three-position switch provides three options for operating the motor: constant on, momentary, and high-bypass.

- **Constant on:** This allows the motor to run continuously at the speed selected by the speed control knob without the use of the momentary switch.
- **Momentary:** This allows the motor to activate with the momentary switch at the speed selected by the speed control knob.

TROLLING MOTOR OPERATION

- **High-bypass:** This will automatically deliver full thrust when the momentary switch is activated.

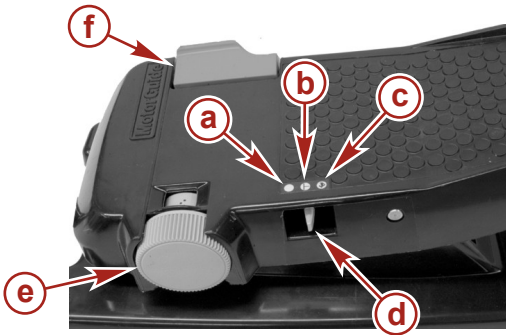

- a** - Constant on
- b** - Momentary
- c** - High-bypass
- d** - Three-position switch
- e** - Speed control knob
- f** - Momentary switch

46291

Twist Tiller Speed Control

Twist tiller handle: Rotate the handle clockwise for forward speeds and counterclockwise for reverse speeds.

Toggle switch: Flip the toggle switch to "—" to turn the motor on and "O" to turn the motor off. This switch is available on variable speed motors only.

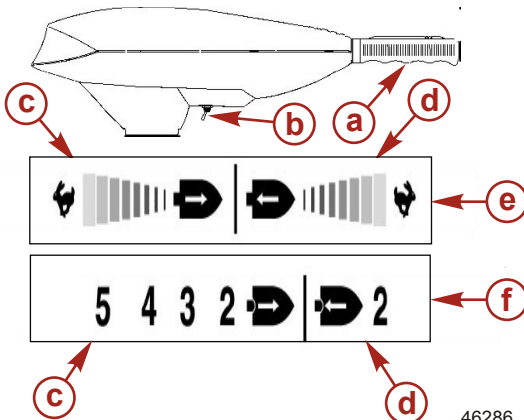

- a** - Twist tiller handle
- b** - Toggle switch
- c** - Forward speed
- d** - Reverse speed
- e** - Variable speed decal
- f** - Five-speed decal

46286

Permanent Foot Pedal Mounting

1. Place the foot pedal in the desired location on the boat deck.
2. Using a 3 mm (7/64 in.) drill bit, drill holes through the holes in the foot pedal base and into the boat deck.

TROLLING MOTOR OPERATION

3. Use four #8 x 2 inch stainless screws and screw the foot pedal base securely to the boat deck.

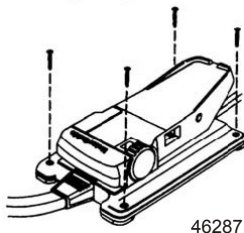

MAINTENANCE

Trolling Motor Care

To keep your trolling motor in the best operating condition and retain its dependability, your trolling motor must receive periodic inspections and maintenance. Keep it maintained properly to ensure the safety of you and your passengers.

WARNING

Neglecting to inspect, maintain, or repair your trolling motor can result in product damage or serious injury or death. Do not perform maintenance or service on your trolling motor if you are not familiar with the correct service and safety procedures.

Record all maintenance performed and save maintenance work orders and receipts.

SELECTING REPLACEMENT PARTS

Use only original MotorGuide replacement parts.

Inspection and Maintenance Schedule

BEFORE EACH USE

- Inspect for loose or corroded wiring connections.
- Check the tightness of the battery lead connections.
- Check the tightness of the propeller nut.
- Check the propeller blades for damage.

AFTER EACH USE

- Disconnect the battery cables from the power source or unplug the motor from the boat.
- Check each side of the propeller and propeller shaft for debris such as weeds and fishing line. Remove all debris.
- Check the tightness of the propeller nut.
- Rinse the trolling motor with clean water to remove dirt and dust that may scratch the surface.

MAINTENANCE

EVERY 100 HOURS OF USE OR ANNUALLY

- Periodically lubricate all the pivot points with a nonaerosol, nonsolvent based lubricant.

IMPORTANT: Never use an aerosol lubricant to grease or oil any part of the unit. Many aerosol lubricants contain harmful propellants that can cause damage to various parts of the trolling motor.

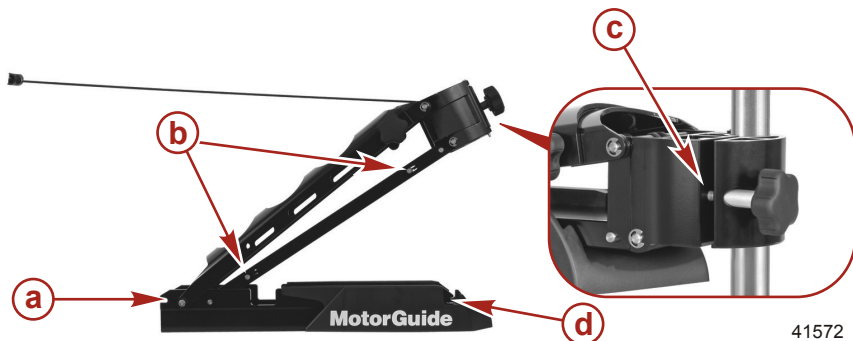

41572

Lubrication points

- a** - Rear deck channel grooves
- b** - Lockslide pin
- c** - Door knob shaft
- d** - Forward deck channel grooves

Tube Ref No.	Description	Where Used	Part No.
 95	2-4-C with Teflon	Pivot points	92-802859A 1

- Check the tightness of bolts, nuts, and other fasteners.
- Inspect the battery. Refer to **Battery Inspection**.

Storage Preparation

The major consideration in preparing your trolling motor for storage is to protect it from corrosion and damage caused by freezing of trapped water.

MAINTENANCE

Refer to the **Maintenance—Inspection and Maintenance Schedule** section and complete the appropriate care instructions to prepare your trolling motor for storage. Store the trolling motor in a dry location where it will not be affected by temperatures below $-29\text{ }^{\circ}\text{C}$ ($-20\text{ }^{\circ}\text{F}$).

IMPORTANT: Trolling motors stored in temperatures below $0\text{ }^{\circ}\text{C}$ ($32\text{ }^{\circ}\text{F}$) should be operated slowly for a minimum of 15 minutes before going above 30% operation.

Battery Inspection

The battery should be inspected at periodic intervals to ensure proper trolling motor operation.

IMPORTANT: Read the safety and maintenance instructions which accompany your battery.

1. Ensure that the battery is secured to the vessel.
2. Ensure that the battery cable terminals are clean, tight, and correctly installed. For installation instructions, refer to **Wiring and Battery**.
3. Ensure that the battery is equipped with a battery box to prevent accidental shorting of the battery terminals.

Propeller Replacement

WARNING

Performing service or maintenance without first disconnecting the battery can cause product damage, personal injury, or death due to fire, explosion, electrical shock, or unexpected motor starting. Always disconnect the battery cables from the battery before maintaining, servicing, installing, or removing motor components.

REMOVING THE PROPELLER

1. Disconnect the battery cables from the power source.
2. While holding the propeller blade with one hand, use a propeller wrench or pliers to remove the propeller nut.

IMPORTANT: If the propeller cannot be removed easily, hold one blade and use a rubber mallet to lightly tap the backside of the opposite blade. If the propeller cannot be removed, refer to Troubleshooting.

MAINTENANCE

NOTE: If the propeller pin is bent, replace the propeller pin.

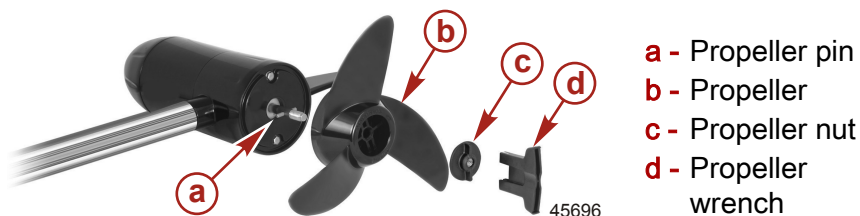

Recommended MotorGuide Accessory Description	Part Number
MotorGuide Prop Wrench Kit	MGA050B6

INSTALLING THE PROPELLER

1. Rotate the motor shaft to insert the propeller pin horizontally.
2. Install the propeller onto the motor shaft by engaging the propeller onto the propeller pin.
3. Install the propeller nut. Tighten securely.
4. Use a MotorGuide propeller wrench or pliers to tighten the propeller nut another $\frac{1}{4}$ turn.

Great White Saltwater Models Only

Corrosion on the metal components of the trolling motor occurs when two or more metals that are dissimilar are brought into electrical contact underwater.

The use of a sacrificial anode causes all of the other metals on the trolling motor to become the cathodes. The anode will corrode and the trolling motor will not.

Maintenance: If excessive corrosion occurs, replace the anode.

Recommended MotorGuide Accessory Description	Part Number
Sacrificial Anode Kit	MAR00204

OWNER SERVICE ASSISTANCE

Troubleshooting

NOTE: For service information, contact any certified MotorGuide service center. For a full listing of MotorGuide service centers, go to www.motorguide.com or contact any Mercury Marine service office.

Symptom	Possible Cause	Resolution
Loss of power	Weak 12 volt trolling motor battery	Check 12 volt battery charge. Recharge or replace battery as required.
	Loose or corroded battery connections	Inspect battery connections for cleanliness and tightness.
	Propeller is loose, damaged, or off-balance	Refer to Removing the Propeller .
	Wiring or electrical connection faulty	Wire gauge from the battery to the trolling motor is insufficient. 6 gauge wire is recommended.
	Magnets cracked or chipped	The motor will whine or grind. Contact service center.
	Water intrusion in the lower unit	Contact service center.
Excessive noise, vibration	Motor shaft is bent	Contact service center.
	Propeller is loose, damaged, or off-balance	Refer to Removing the Propeller .
	Damaged bearings or bushings	Contact service center.
	Magnets interfering with armature	Turn off the power and manually rotate the propeller. If the propeller does not rotate freely with a slight magnetic drag, contact service center.
	Magnets cracked or chipped	The motor will whine or grind. Contact service center.

OWNER SERVICE ASSISTANCE

Symptom	Possible Cause	Resolution
Motor failure (motor runs at partial speed)	Electrical	Connections in the top housing may be loose or damaged. Contact service center.
	Thermal protection	Temperature exceeds specification. Contact service center.
	Damaged speed potentiometer	Contact service center.
	Propeller is loose, damaged, or off-balance	Refer to Removing the Propeller .
Motor failure (motor does not run)	Weak 12 volt trolling motor battery	Check 12 volt battery charge. Recharge or replace battery as required.
	Loose or corroded battery connections	Inspect battery connections for cleanliness and tightness.
	Wiring or electrical connection faulty	Wire gauge from the battery to the trolling motor is insufficient. 6 gauge wire is recommended.
	Electrical	Check the connector for a loose or damaged connection. Contact service center.
	Thermal protection	Temperature exceeds specification. Contact service center.
	Three-position switch is damaged	Contact service center.
	Fuse on circuit breaker is open	Replace the fuse or reset the circuit breaker only after determining the root cause of the problem.
	Magnets interfering with armature	Turn off the power and manually rotate the propeller. If the propeller does not rotate freely with a slight magnetic drag, contact service center.
	Boat wiring	Contact service center.

OWNER SERVICE ASSISTANCE

Symptom	Possible Cause	Resolution
The motor does not operate in the same direction as the directional indicator	Directional indicator misaligned	Contact service center.
Mount is hard to unlatch with the pull rope	Mount bracket is not level or twisted	Loosen or twist the two forward bracket screws slightly and latch the bracket. Continue to loosen each of the bracket screws until the bracket releases easily. If necessary, install shim washers (not supplied) and then tighten the screws. Refer to Mount Installation for help.
Difficulty removing propeller	Bent propeller pin	Hold one blade and lightly tap the opposite blade with a rubber mallet. Use a putty knife on both sides of the propeller to apply equal pressure.
	Bent armature shaft	Contact service center.

Service Assistance

Your satisfaction with your product is very important to us. If you have a problem or question about your motor, contact your dealer or any certified MotorGuide Service Center. For more service assistance information, refer to **Warranty Information**.

The following information will be needed by the service office:

- Your name and address
- Daytime telephone number
- Model and serial number of your trolling motor
- Proof of purchase or registration verification
- Nature of problem

Mercury Marine Service Offices

For assistance, call, fax, or write. Please include your daytime telephone number with mail and fax correspondence.

OWNER SERVICE ASSISTANCE

United States, Canada		
Telephone	English - (920) 929-5040 Français - (905) 636-4751	Mercury Marine W6250 W. Pioneer Road P.O. Box 1939 Fond du Lac, WI 54936-1939
Fax	English - (920) 929-5893 Français - (905) 636-1704	
Website	www.motorguide.com	

Australia, Pacific		
Telephone	(61) (3) 9791-5822	Brunswick Asia Pacific Group 132-140 Frankston Road Dandenong, Victoria 3164 Australia
Fax	(61) (3) 9706-7228	

Europe, Middle East, Africa		
Telephone	(32) (87) 32 • 32 • 11	Brunswick Marine Europe Parc Industriel de Petit-Rechain B-4800 Verviers, Belgium
Fax	(32) (87) 31 • 19 • 65	

Mexico, Central America, South America, Caribbean		
Telephone	(954) 744-3500	Mercury Marine 11650 Interchange Circle North Miramar, FL 33025 U.S.A.
Fax	(954) 744-3535	

Brunswick Asia Pacific Group		
Telephone	(65) 65466160	T/A Mercury Marine Singapore Pte Ltd 29 Loyang Drive Singapore, 508944
Fax	(65) 65467789	