



OceanLED Marine
Product Support

**Sport Series
DockLight
Installation Manual**

OceanLED

This installation manual covers the following products:

Sport DockLight



Sport Series DockLight

S3116d	S3124d
--------	--------

OceanLED reserve the right to change this document without notice. Please refer to www.oceanled.com for latest documentation.



IMPORTANT: Please read the instructions completely before proceeding with the installation. These instructions supersede any other instructions if they differ.

Chapter 1.....4
An overview of the underwater light installation and mounting locations.

Chapter 2.....7
Detailed instructions on how to mount and connect each type of light.

Chapter 3.....13
Maintenance and troubleshooting tips.

PRETEST

Always test the lights prior to installation. Failure to do this may result in additional installation time and could invalidate the warranty.

GENERAL

OceanLED underwater dock lights are generally used for illuminating the waters around marinas and waterways. Best placement for achieving the best results are described in selecting the right location.

WARRANTY COVERAGE

2 year warranty from time of purchase, regardless of installation date.
Please refer to www.oceanled.com/downloads for full warranty statement.

WARNING!

Never Use Solvents! Cleaners, fuel, paint, sealants, and other products that may contain strong solvents, such as acetone, that attack many plastics greatly reducing their strength and irreversibly damaging the special lens coatings and cable sheathings.

WARNING!

Do not submerge your cable ends in water; cable and connections exposed to underwater submersion will not be covered by warranty. Mounting the light in any other configuration, other than those described in this guide, will invalidate its warranty.



IMPORTANT SAFETY PRECAUTIONS!

ATTENTION INSTALLER: This manual contains important information about the installation, operation and safe use of this product. This information should be given to the owner and/ or operator of this equipment.

CAUTION: (Risk Group 2): Possibly hazardous optical radiation emitted from this product. Do not stare at operating lamp. May be harmful to the eye.



CLASS 3: This equipment is designed to operate at voltages of less than 50v DC.

WARNING

- Before installing your OceanLED Light, read and follow all warning notices and instructions which are included. Failure to follow safety warnings and instructions can result in property damage, severe injury or even death.
- Before installing your OceanLED Light, check local laws for restrictions regarding the use of colored lights in your area.
- It is advised not to operate lights out of water for a period longer than 5 minutes. Exceeding this may cause damage to the light unit
- Salt is an inherently corrosive material. Metal parts and certain natural and man-made surfaces are particularly susceptible to corrosion and deterioration when used in and around salt water. Some OceanLED lights contain combinations of plastic and polymer products which are impervious to salt water corrosion, however, screws and fasteners used for the installation must be of a marine grade type stainless steel or equivalent and monitored annually to ensure the lights remain in service for years to come.
- Never Use Solvents! Cleaners, fuel, and other products that may contain strong solvents, such as acetone, that attack many plastics greatly reducing their strength and irreversibly damaging the special lens coatings and cable sheathings.

DANGER! Risk of Electrical Shock or Electrocutation!

 This underwater light must be installed by a licensed or certified electrician in accordance with all applicable local codes and ordinances. Improper installation will create an electrical hazard which could result in death or serious injury to swimmers, installers, or others due to electrical shock, and may also cause damage to property. Always disconnect the power to the light at the circuit breaker before servicing the light. Failure to do so could result in death or serious injury to serviceman, swimmers or others due to electrical shock.

READ AND FOLLOW ALL INSTRUCTIONS IN THIS MANUAL.

Chapter 1: Overview

This handbook provides instructions to assist you in the installation and set up of the Sport DockLight Series lights from OceanLED.

1.1 Identifying your model

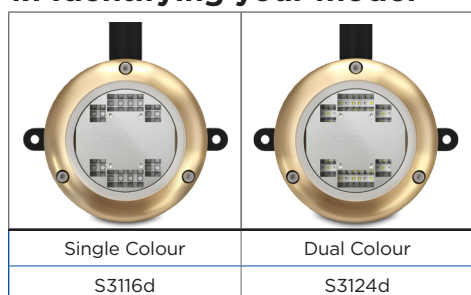

1.2 DC power / fuse ratings

For AC to DC power supply, allow at least 15% reserve for voltage fluctuations due to variables beyond your control such as ambient temperature and supply voltage fluctuations to ensure your lights are always receiving the proper voltage and to ensure the power supply is not “overworked” causing premature failure. Use chart below in determining power supplies.



Model	Current @ 24v DC	Power consumption in Watts	15% reserve in Watts	Recommended fuse 24v DC
S3116d	2.3A	66	76w	7A
S3124d	1.7A	43	50w	7A

1.3 Tools and materials

- Drill
- Pozi head screwdriver
- Zip-ties
- Waterproof cable connectors / butt splices and gluelined heat shrink and/or IP68 junction box(s)
- 1/2" Conduit (schedule 40)
- PVC Solvent Adhesive



1.4 Accessories

<p>SPORT DOCKLIGHT FLOATING KIT #012108</p> <p>Optional Easi-Kleen floating bracket mechanism makes it simple to swing the light out of the water to clean.</p>	
<p>4 WAY V DC POWER JUNCTION BOX #019901</p> <p>Provides 4x individually fused outputs.</p>	
<p>POWER SUPPLY 001-600072</p> <p>Powers 2 x S3116d Single Colour or Powers 3 x S3124d Dual Colour</p>	

Products may vary from image shown.



Finding The Mounting Location

Considerations

- **Design** - Your new OceanLED Dock Light(s) have a wide angle light beam that allows you to engineer a beautiful look around your property. Consider even spacing, boat traffic, tidal fluctuations, storms, seasons, and the overall desired effect when designing your installation.
- **Depth** - Fixed Piling or Bulkhead - The lights should be mounted approximately 300mm - 500mm (UK) / 12" - 20" (US) below mean low water. Keep in mind that you will want them mounted within reach of a cleaning brush on a pole for standard maintenance.
- **Spacing** - Your lights should be spaced evenly between 5 feet to 10 feet (1.5 meters to 3.0 meters) apart depending on the effect you wish to achieve, the clarity of the water (clear water: 10 feet/3 meters; dirty water: 5 feet/1.5 meters), and considering the overall design of the installation.

Example Dock Light Installation

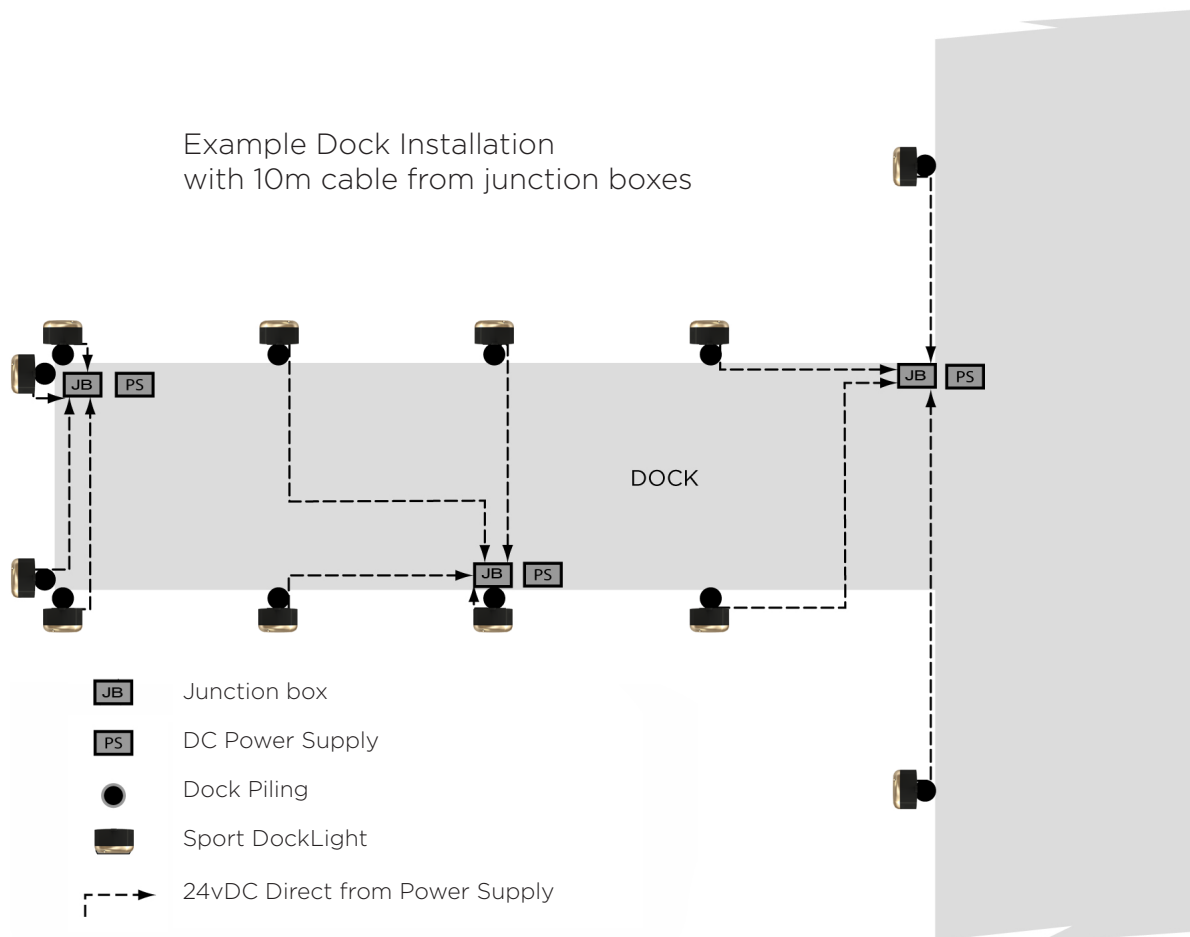



Chapter 2: Installation

Note: OceanLED makes every effort to protect our marine and fresh water environment as well as our natural resources. Please take care to keep packaging away from and out of the water by ensuring loose packaging materials are secured and not susceptible to being blown into the water. Please recycle all packaging materials as the sustainability of our environment is everyone's responsibility.

WARNINGS:

- Never use power tools to secure your lights; hand tighten only.
- We recommend you use screws provided. If alternative screws are used, do not use counter sunk or non flat shoulder screws to secure your lights.
- Please check all components prior to installation. If there is any damage to connectors, cables, and/ or any other component, please notify OceanLED BEFORE installation. Failure to notify OceanLED of damage in transit prior to installation will lead to violation of warranty.
- Do not submerge your cable in water; cable and connections exposed to underwater submersion will not be covered by warranty. Mounting the light in any other configuration, other than those described in this guide, will invalidate its warranty.

2.1 Installing Dock Light Model Light Fixtures

Fixed

1. Install ½ inch conduit into dock light, feeding the cable through the conduit. Bond the conduit to the dock light using PVC solvent weld adhesive (not supplied).
2. Mark the positioning of the 2x mounting holes and drill pilot hole or adequate sized hole for screw anchor / wall plug.
3. Attach the unit to the installation surface using 2x screws provided.
4. Once the light is installed protect the top of the conduit from water ingress

Floating

1. Install ½ inch conduit into dock light, feeding cable through the conduit. Bond the conduit to the dock light using PVC solvent weld adhesive (not supplied).
2. Install the other end of the conduit into Tee adapter feeding cable through the 90° exit and bond in place using PVC solvent weld adhesive (not supplied)
3. Mark the positioning of the 4x mounting holes on the metal bracket and drill pilot hole or adequate sized hole for screw anchor / wall plug.
4. Fix the conduit in place using the central detent pin. Ensure the pin is pushed all the way through both sides of the bracket.
5. The light can now be lowered into the water and locked into place using the bottom detent pin.



2.2 Connecting lights to your power source

WARNINGS:

- Always consult a qualified electrician when connecting OceanLED light fixtures.
- When connecting light units, please note that all OceanLED lights will operate within a specific voltage range.

Connecting lights to your DC power source

OceanLED Sport models require a 24v DC supply. This supply should be a minimal 3A @ 24v DC per light. It is recommended to connect the light to the DC power source using a two pole, screw type terminal block with a minimum voltage rating of 50V and a current rating of at least 6A. The ends of the cable should be stripped back (if required) and suitable ferrules fitted. The terminal block should be fixed inside a waterproof enclosure (IP66 minimum).

Tip: For complete instructions on vDC connections, please refer to The National Electric Code and consult local electrical codes.

WARNING:

Never leave the bare cables unprotected. Take care to not leave the bare wire ends in water before making the waterproof connections. Water deposits in the connectors and cables will cause corrosion. Over time water can also work its way into the unit along the inside of the cable due to capillary action causing the light to fail. This will NOT be covered under warranty.

1. Depending on the model and number of lights installed you will need to pull the correct sized power cable from the breaker/fuse panel to the light locations to supply constant power to the units. It is imperative that the correct sized cable is used to avoid voltage drop issues. See appendix for recommended cable gauges.
2. Using waterproof butt splices or IP66 waterproof junction boxes, make the connections at either end of the system to attach the lights to the DC system. If appropriate, use a dielectric grease when making the connections and make sure any heat shrink used completely encapsulates the outer wire sheath (the use of glue-lined heat shrink is highly recommended to ensure water tightness).

Note: Corrosion of wire, and/or water ingress into the light unit via the cable is NOT covered under warranty.

3. If you are not installing a custom fuse panel, it is imperative that the OceanLED supplied fuse is installed on each power line from each light. See table in chapter 1.
4. Secure cables ensuring where the cable exits the light it is not under undue stress. Finish and test light units, if you have any issues and need troubleshooting advice, please contact your local OceanLED representative.

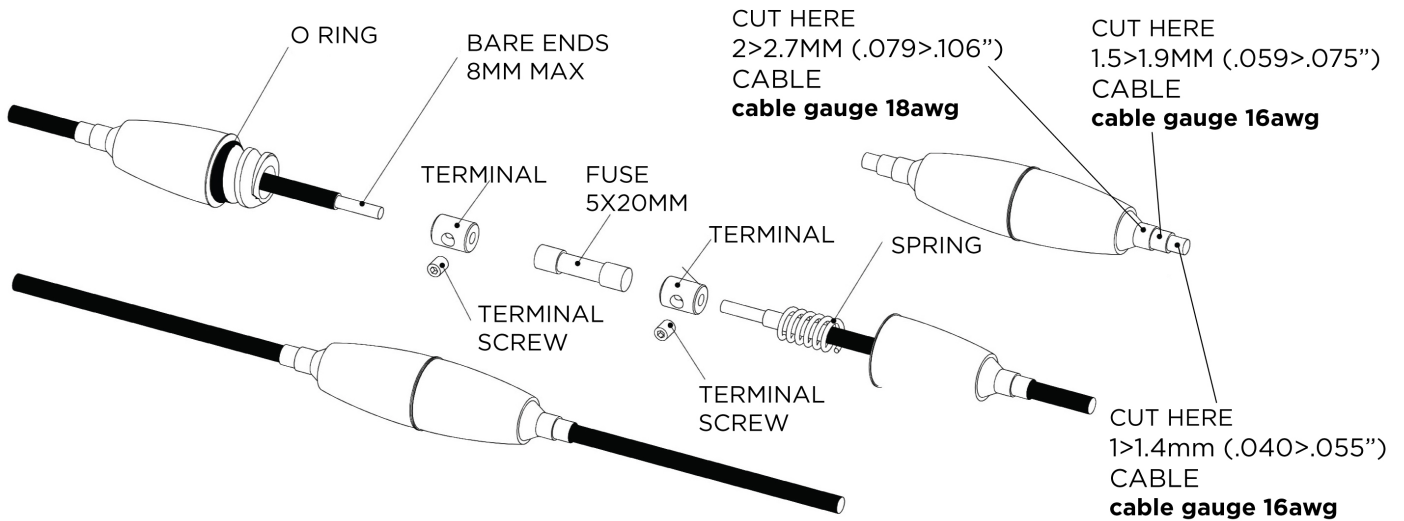

Connection Diagram

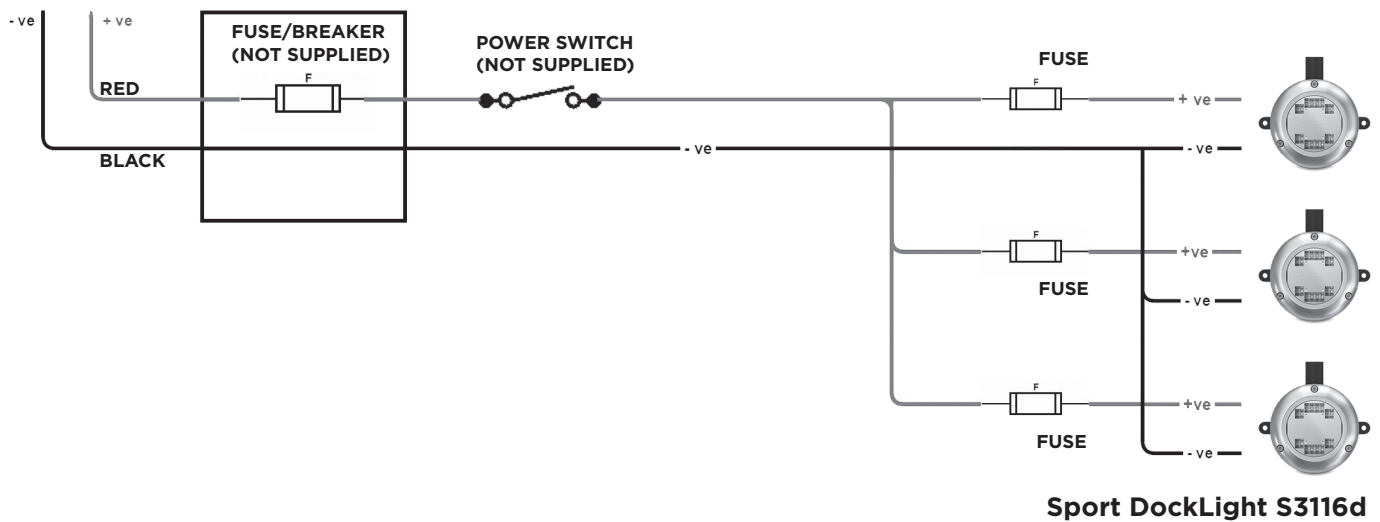

Power Supply requirements

A suitably fused 24v supply is required for each light. **DO NOT CONNECT DIRECTLY TO MAINS AC!** A 7 Amp fuse / breaker is recommended for each light.

When selecting the mains AC to DC converter(s) it is important to ensure that the overall power requirements are met, allowing a 'reserve' of at least 15% of the overall power to allow for losses in cable runs.

When connecting multiple lights to one power source the OceanLED 4-way junction box is recommended as this provides four independent separately fused outputs for each light.



Power Cable selection

It is important to select the correct size cable for the supply to the dock lights. The required cable gauge depends on the current draw and the length of the cable run from the power source to the light(s). Note that where the power source is remote from the power junction box connected to each light, this cable will carry the total current for all the connected lights, and should be sized correctly to prevent excessive voltage drop and power loss.

The cables from the power junction box to the lights themselves can be a smaller gauge, but again should be correctly selected depending on their length to prevent excessive voltage drop. Please refer to the cable gauge diagram in the Appendix.

NOTE: THE SUPPLY CABLE MUST BE PROTECTED BY A SUITABLE FUSE OR BREAKER.

2.3 Finalize your OceanLED installation

Test your lights

At this final stage make sure all of the system is operational. See Chapter 3 Operation. If you have any issues, please contact your local OceanLED representative.



Chapter 3: Operation, Maintenance, Repair, & Parts

CHAPTER

3

THREE

3.2 Dual Colour Operation

The Dual colour change has four modes of operation;

1. Single colour white - this mode is entered when the light is first turned on.
2. Single colour blue
3. Fade - Fade between white and blue.
4. Dual colour (blue and white both on)

To cycle between the above modes, turn off the light for less than 1 second, then back on again.

PLEASE NOTE: Fade mode is not guaranteed to stay in sync between lights over time.

3.3 Sport Dual Colour Configuration Mode

Description: Enables selection of either white or blue colour as default at power up.

To enter configuration mode:

1. Turn on light(s)
2. Wait around 1 second (or until light(s) illuminate)
3. Turn off light(s)
4. Wait for a minimum of 5 seconds then turn light(s) back on again.
5. Repeat steps 2-4 another 4 times. (If the light changes mode on re power up then the light has not been turned off for long enough in step 4)
6. On the 5th power up, the light(s) should enter the configuration mode - this will be confirmed with a sequence of five blue/white flashes followed by a steady white (the steady colour indicates the default start up colour).

Setting the default start up colour:

1. Once the configuration mode has been entered (see above). Toggling off the power and back on again quickly (as in a normal mode change) will toggle between the default start-up colours (blue & white). This is indicated by the colour displayed after the blue/white flash sequence.
2. To save the selected state simply turn off the light(s) when the required start up colour is displayed and wait for 5-10 seconds.
3. The light(s) should now be configured to start with the selected colour as default.



Chapter 4: Installation

4.1 - Cleaning Instructions

Sea growth can collect quickly on the light and this can reduce the performance in just a few weeks. To prevent the build-up of sea growth, all OceanLED lights have been coated with a specialized Tritonium coating which makes the surface of the lens a non-stick layer which helps ward off long term barnacle buildup. Lights should be cleaned with a boat brush or similar biweekly or as needed to keep the lens of the light clear. Growth varies greatly around the world and maintenance is imperative to the proper operation and longevity of the product. If heavy fouling occurs, barnacles can be removed from the lens using a plastic scraper and moderate pressure. This can be done in the water using a plastic scraper. If out of water, moisten the growth before wiping.

CAUTION:

Harsh cleaning solvents will damage the light and Tritonium coating.



4.2 Troubleshooting Common Problems and Their Solutions

Sport DockLight				
Problem	Check	Result	Fix	
Light does not look bright	Check that there is no marine growth on the lens.	Sea life / Barnacles present	Clean the lens as per Chapter 3.	
	Check voltage supply to the light is between 20 volts and 28 volts DC.	Voltage is either too high or too low	Investigate reason for high or low voltage and fix.	
	Check voltage supply is stable and does not fluctuate.	Voltage is fluctuating	Investigate reason for voltage fluctuation and fix.	
	Check that the electrical connections between the driver power cable and the supply cable have been made correctly.	Poor electrical connection	Remake connection and seal joint correctly.	
	Confirm all LEDs are illuminated.		1 - 5 LEDs are not working	Contact your dealer.
			6+ LEDs are not working	Typically this is due to water penetration of the cable due to poor connection or abraded cable.
	Check lights to see if water is present inside the light.	Water present	If water is present contact your dealer. Typically this is due to water penetration via the cable due to poor connection or damaged cable.	



4.2 Troubleshooting Common Problems and Their Solutions

Sport DockLight			
Problem	Check	Result	Fix
Light does not light up.	Check that there is power supplied to the light cable connection.	Poor electrical connection.	Trace the cables back, checking at joints until break has been located.
	Check that the wiring polarity is correct, red to positive and black to negative.	Polarity incorrect.	Change the wiring polarity and seal joint correctly.
	Check that there is power supplied to the light cable connection.	Replace fuse.	If fuse keeps blowing then there is a short circuit in the light system that must be traced and rectified. If no external short can be located contact your local OceanLED representative.
Light has water inside.	Check connections to make sure they are not submerged in water.	Light will require replacing.	This is not covered by the warranty.
	Check cable to make sure there is no damage to the cable. (If cable is damaged, it must only be replaced by OceanLED, service agent or similar qualified person).	Light will require replacing.	This is not covered by the warranty.



Chapter 5: Appendix

SUPPLY CABLE CONDUCTOR SIZE CHART								
CABLE LENGTH (FEET)	CIRCUIT CURRENT							
	2 AMP	4 AMP	6 AMP	8 AMP	10 AMP	12 AMP	14 AMP	16 AMP
0-5	18 AWG	18 AWG	16 AWG	16 AWG	16 AWG	14 AWG	14 AWG	14 AWG
10-15	18 AWG	18 AWG	16 AWG	16 AWG	14 AWG	14 AWG	14 AWG	14 AWG
15-20	18 AWG	18 AWG	16 AWG	14 AWG	14 AWG	14 AWG	12 AWG	12 AWG
20-25	18 AWG	16 AWG	14 AWG	14 AWG	12 AWG	12 AWG	12 AWG	10 AWG
25-30	18 AWG	16 AWG	14 AWG	12 AWG	12 AWG	10 AWG	10 AWG	10 AWG
30-35	18 AWG	14 AWG	14 AWG	12 AWG	10 AWG	10 AWG	10 AWG	8 AWG
35-40	18 AWG	14 AWG	12 AWG	12 AWG	10 AWG	10 AWG	8 AWG	8 AWG
40-45	16 AWG	14 AWG	12 AWG	10 AWG	10 AWG	8 AWG	8 AWG	8 AWG
45-50	16 AWG	14 AWG	12 AWG	10 AWG	10 AWG	8 AWG	8 AWG	8 AWG
50-55	16 AWG	12 AWG	10 AWG	10 AWG	8 AWG	8 AWG	8 AWG	4 AWG
55-60	16 AWG	12 AWG	10 AWG	10 AWG	8 AWG	8 AWG	4 AWG	4 AWG
60-65	14 AWG	12 AWG	10 AWG	8 AWG	8 AWG	8 AWG	4 AWG	4 AWG
65-70	14 AWG	12 AWG	10 AWG	8 AWG	8 AWG	4 AWG	4 AWG	4 AWG
70-75	14 AWG	12 AWG	10 AWG	8 AWG	8 AWG	4 AWG	4 AWG	4 AWG
75-80	14 AWG	10 AWG	10 AWG	8 AWG	4 AWG	4 AWG	4 AWG	2 AWG
80-85	14 AWG	10 AWG	8 AWG	8 AWG	4 AWG	4 AWG	4 AWG	2 AWG
85-90	14 AWG	10 AWG	8 AWG	8 AWG	4 AWG	4 AWG	2 AWG	2 AWG
90-95	14 AWG	10 AWG	8 AWG	8 AWG	4 AWG	4 AWG	2 AWG	2 AWG
95-100	12 AWG	10 AWG	8 AWG	4 AWG	4 AWG	4 AWG	2 AWG	2 AWG

© 2016 Ocean LED Marine LTD
All Rights Reserved

Specifications are subject to change
without notice.

Trademarks are the property of
Ocean LED Marine LTD

Ocean LED Marine LTD

Unit 1 Jacknell Road
Dodwells Bridge Industrial Estate
Hinckley,
Leicestershire LE10 3BS
United Kingdom
Tel: +44 (0) 1455 637505
Fax: +44 (0) 1455 238553
service@oceanledusa.com

OceanLED USA LLC

778 South Military Trail
Deerfield Beach
Florida
FL 33442-3025
United States
Tel: +1 954.523.2250
Fax: +1 954.523.2249
service@oceanledusa.com



www.oceanled.com