

OWNER MANUAL

Version 1.0

Product description

The only wireless ZigBee® GPS in the market. Tracks boat location and movement. Sends alarms when the boat is out of the set geofencing area. GPS positioning allows detection if your anchor starts to drag. Moreover, shows both the current daily weather forecast and for the next 7 days.

Placement

The ZigBee® GPS/Tracking can be installed both inside and outside the boat. When installed outside, choose a location for the sensor that has a clear view of the sky. Ensure there are no obstacles in the immediate proximity to the sensor. The sensor relies on direct "line of sight" satellites reception. If you are not sure that the chosen location is suitable, it is advisable to install the antenna temporarily to verify correct operation. The GPS positioning requires at least 4 satellites locked by the GPS receiver.

NOTE: For metal boats, the sensor must be installed outside.

WARNING: Do not mount the ZigBee® GPS/TRACKING in the immediate proximity of electromagnetic fields, radio-frequency equipments and metal obstacles. Keep the separation distance from other antennas to avoid mutual interference:

- RADAR antenna: do not mount within radar beam
- VHF antenna: more than 1m
- HF antenna: more than 4m
- Satellite voice communication: do not mount within Inmarsat/Iridium beam

Assembly Instructions

Mount the sensor facing upwards and in a level position. There are 2 mounting options with the supplied mount. The ZigBee® GPS/Tracking can be assembled with any mount with 1"-14 standard thread. **SUGGESTION:** keep the supplied power cable at least 50 cm (1.64 ft) in length to make the assembly and disassembly phases easier.

OPTION 1: Pass the power cable through the supplied mount central hole

- Check that the collar and the cable slot cover are mounted in the mount.

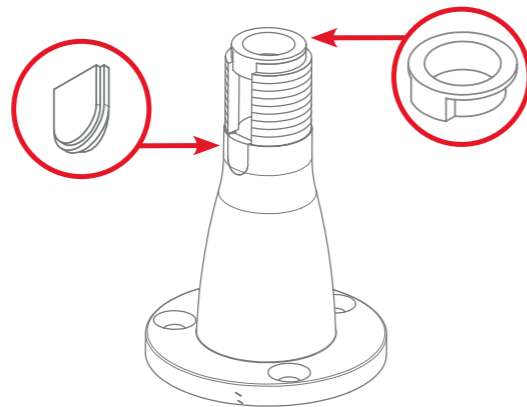

- If necessary, insert the cover into the mount cable slot and put the collar in the upper part of the mount
- Pass the power cable through the central hole of the supplied mount
- Screw the sensor into the mount

NOTE: During this operation, be careful not to damage the power cable.

- Connect the power cable to a 12/24V DC power source (red cable: positive pole, black cable: negative pole). Check that the status LED (located on the back) is on and colored red.

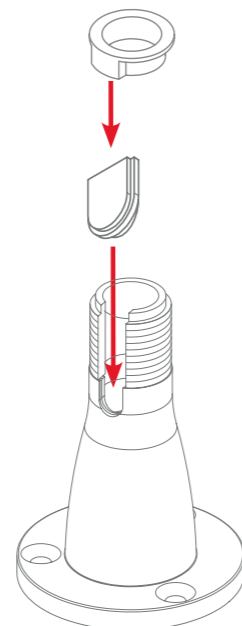

- Fix the mount with 3 screws (not supplied)

OPTION 2: Pass the power cable through the supplied mount side cable slot

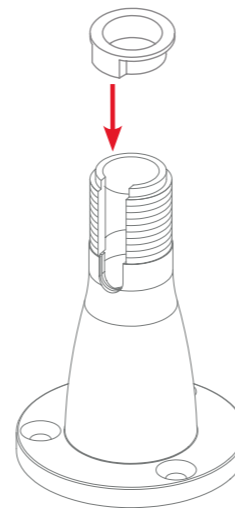

- Remove the cable slot cover from the supplied mount
- Place the collar in the upper part of the mount (if already assembled, skip this step)
- Fix the mount with 3 screws (not supplied)
- Pass the power cable through the mount cable slot
- Screw the sensor into the mount

NOTE: During this operation, be careful not to damage the power cable

- Connect the power cable to a 12/24V DC power source (red cable: positive pole, black cable: negative pole). Check that the status LED (located on the back) is on and colored red.

Disassembly Instructions

OPTION 1 - Power cable through the supplied mount central hole

- Unscrew the screws on the mount
- Pull up the ZigBee® GPS/Tracking till the end of the supplied power cable
- Disconnect the power cable from the power source
- Unscrew the mount from the GPS antenna (NOTE: hold the GPS antenna with the hand)

OPTION 2 - Power cable through the mount side cable slot

- Disconnect the power cable from the power source
- Unscrew the GPS from the mount

Adding the sensor to the Gateway

NOTE: Make sure the gateway is turned on and configured correctly. For more details, please see the gateway installation manual.

WARNING: Make sure the FW version of the Gateway ZigBoat™ is 1.2 or later. To check which version of firmware is currently installed on the ZigBoat™ Gateway, click the button Menu on the top right (fig.1), select Setting and then Firmware Update tab. The firmware currently installed is reported in the row "Firmware installed".

Fig. 1

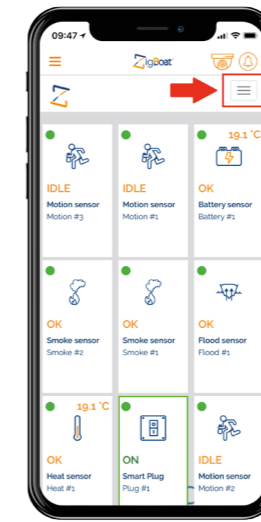

1. Open the ZigBoat™ APP, select the Gateway in the ZB Gateways menu and wait a few seconds. Then, select the "menu" button on the top right (fig. 1). Select "Device list" (fig. 2). Add the sensor by

Fig. 2



entering the serial number which is on the sensor's label and in this manual (fig. 3)

Fig. 3

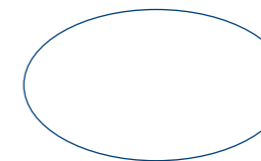

2. You can change the device name by selecting "Sensor Name" (fig. 4) Then, press the "Add Device" button

Fig. 4

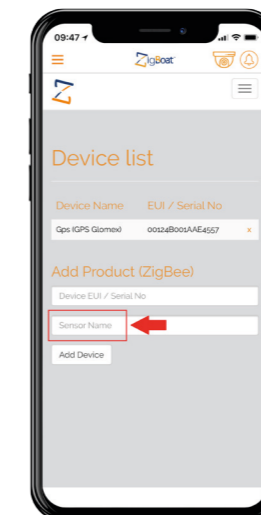

NOTE: If the field "Sensor Name" is not filled up, the sensor is identified by default via its serial number

- WARNING:** it is possible to join only one GPS sensor for Gateway.
3. The GPS sensor will now start searching for the ZigBoat™ network to join.
 4. When the status LED is green, the sensor has successfully joined the ZigBoat™ network
 5. To check the correct configuration, select the overview tab of the ZigBoat™ App (fig.5).

Fig. 5

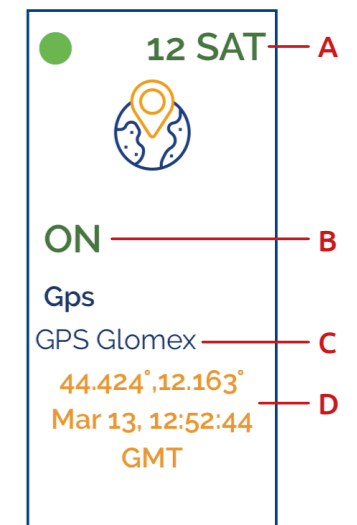

Green dot: The sensor is working properly

Red dot: The sensor is not able to reach the Gateway:

• Please check that the device is properly powered

• Please check the serial number has been entered correctly

• In case of weak signal, change the position of the GPS: check that there are no metal obstacles between the Gateway and the GPS sensor.

A - Number of GPS satellites in use

B - Geofencing status:

• ON: Geofencing enabled

• DISABLED: Geofencing disabled

• ALARM: the boat is outside of the geofence

C - GPS sensor name

D - Latitude/Longitude and Date/Time: Shows the coordinates of the last boat location detected by the sensor. By clicking on this information, the GPS section is accessed directly.

GPS Section

To access the GPS section, click on the Menu button at the top right (fig. 1) and select GPS (fig. 6)



Fig. 6

NOTE: The map is not available offline. It can only be viewed when both the Gateway and the mobile device (smartphone, tablet) are connected to the Internet. If your smartphone is connected directly to the Wi-Fi network generated by the ZigBoat™ Gateway, the map will not be loaded.

The GPS section is composed by 4 tabs:

- Geofencing/Anchor Watch
- Tracking
- Events
- Weather

Geofencing/Anchor Watch

Shows the map with target and geofence (if geofencing is enabled).

Hybrid map and Google map mode are available (fig. 7)

Here you can check (fig. 8):

- the number of satellites currently hooked up

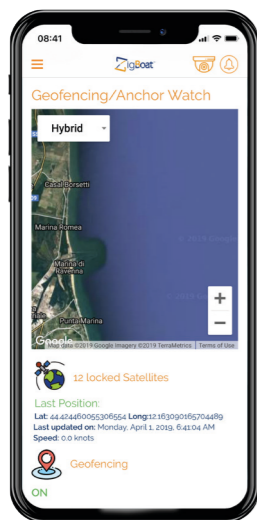

Fig. 7

- the last position: latitude/longitude and date/time of the last update
- speed in knots (sea miles/h)

Geofencing

• Geofencing status:

- N/A: Not available. The GPS is disconnected or the GPS fixing is not ended
- DISABLED: Geofencing is disabled
- ON: Geofencing is enabled
- ALARM: the target is out of the set geofencing area

- "Re-center" button: When geofencing is enabled, it is possible to set the target at the center of the geofencing area based on the last position detected

- "Enable/Disable Geofencing": click here to enable and disable Geofencing

• Geofencing area radius:

You can set the radius of the geofencing area by selecting one of the following options:

- 15m / 49.3 ft (default setting)
- 50m / 164.5 ft
- 100m / 328 ft
- 200m / 657.9 ft
- 1000m / 3289.5 ft

• Tracking

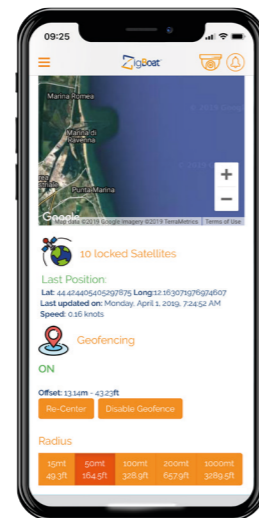

Fig. 8

- You can view the real time location and movements of your boat (fig. 9)

- Routes and average speeds are saved day by day. The route history can be checked up to 100 days

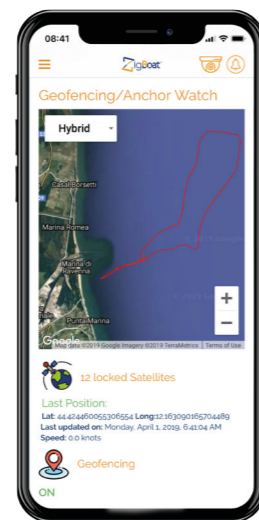

Fig. 9

- In the daily tracking section you can select a day (up to 100 days) and view the route on the map, with info about average speed and miles traveled. Furthermore, by clicking on the route, you can view the following information on the map (fig. 10):

- Latitude
- Longitude
- Speed
- Date/Time

Events

History of events related to the GPS sensor (fig. 11). The following events are reported:

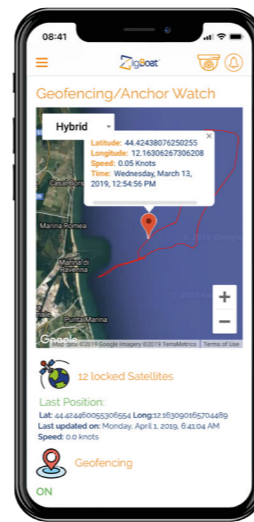

Fig. 10

- Status connection (Connected / Disconnected)
- Geofence status changes
- Left the geofence
- Entry into the geofence

Weather

Shows the current daily weather forecasts and for the next 7 days. (fig. 12)

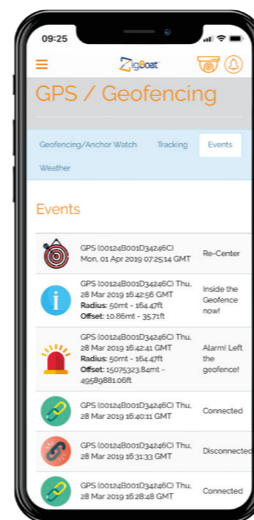

Fig. 11

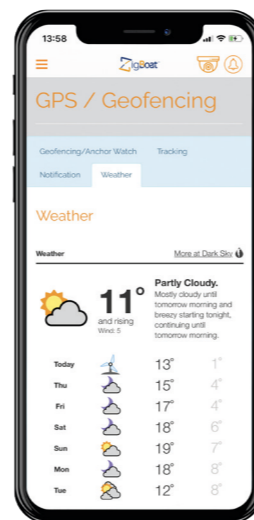

Fig. 12

Resetting

Resetting is needed if you want to connect your GPS to another gateway or if you need to perform a factory reset to eliminate abnormal behavior.

STEPS FOR RESETTING

1. Remove the plastic cap (fig. 13)
2. Check the sensor is powered
3. Press the reset button until the status LED blinks red
4. Release the button
5. Re-insert the plastic cap



Fig. 13

Status LED

The color of the status LED shows the status connection between the GPS ZigBee® and the ZigBoat™ Gateway (fig. 13).

- RED: the GPS sensor is not joined to a Gateway
- ORANGE: the GPS sensor is joined to a Gateway but the Gateway is unreachable.
- GREEN: the GPS sensor is joined to the Gateway and it exchanges ZigBee® telegrams with the Gateway.

The blinking mode of the status LED shows the GPS fixing.

- Blinking: the position is not available (less than 4 GPS satellites locked)
- Steady on: the position is available (at least 4 GPS satellites are locked)

Technical specifications

1. Color: White
2. Dimensions: 100mm (4") Ø / Height: 58mm (2.3") GPS unit + 72mm (2.7") mount
3. Weight: 180 gr (0.4 lb)
4. GPS Rx frequency: L1 (1575.42 MHz)
5. Power supply: 12/24 V DC
6. Power consumption: Max 0.8 W, Typical 0.2 W
7. Connectivity IEEE 802.15.4 / ZigBee® (2.4 GHz)
8. Output power: up to 20 dBm
9. GPS: up to 3 GNSS (GPS, Galileo, GLONASS, BeiDou)
10. Operating temperature: -25°C to +55°C
11. Distance: accuracy: < 10 m (in condition of clear view of the sky)

Simplified EU Declaration of Conformity

The manufacturer Glomex declares that the radio equipment type ZigBee® GPS is in compliance with European Directive 2014/53/EU. The full text of the EU Declaration is available at the following internet address <http://www.glomex.it/leisure/eng/certifications.php>

FCC statement

This device contains FCC ID Z7H-EMB2530PA

NOTE: This equipment has been tested and found to comply with the limits for a Class B digital device, pursuant to part 15 of the FCC Rules. These limits are designed to provide reasonable protection against harmful interference in a residential installation. This equipment generates, uses and can radiate radio frequency energy and, if not installed and used in accordance with the instructions, may cause harmful interference to radio communications. However, there is no guarantee that interference will not occur in a particular installation. If this equipment does cause harmful interference to radio or television reception, which can be determined by turning the equipment off and on, the user is encouraged to try to correct the interference by one or more of the following measures:

- Reorient or relocate the receiving antenna.
- Increase the separation between the equipment and receiver.
- Connect the equipment into an outlet on a circuit different from that to which the receiver is connected.
- Consult the dealer or an experienced radio/TV technician for help.



Other certifications

Distributed by Glomex Srl
via Faentina 165/G
48124 Ravenna
Italy

All rights reserved

Glomex assumes no responsibility for any errors, which may appear in this manual. Furthermore, Glomex reserves the right to alter the hardware, software, and/or specifications detailed herein at any time without notice, and Glomex does not make any commitment to update the information contained herein. All the trademarks listed herein are owned by their respective owners.

Warranty

Glomex guarantees the ZigBoat™ (ZB101) and the GPS Sensor (ZB211) against manufacturing defects for a period of 2 years from date of purchase. Warranty can be in the form of repair or replacement of the unit if manufacturing defects have been found and are confirmed by Glomex or one of its affiliates. In order to validate warranty, either the original sales receipt or a copy must be provided at the time warranty is requested. Before returning any items for warranty, please contact the Glomex Customer Service department to receive a RMA which should be completed and sent with the unit to the following address:

GLOMEX S.r.l.
Via Faentina 165/G
48124 Ravenna (Italy)

complete with all the accessories supplied at the time of purchase for shipment. The serial number must neither be erased nor made illegible, otherwise the warranty will be voided.



Consulta il manuale utente in italiano su:

Consultez le manuel d'utilisation en français sur:

Siehe das deutsche Benutzerhandbuch auf:

Consulte el manual de usuario en español en:

