

 SEAKEEPER
RIDE

YOU'RE IN FOR ONE
HELL
OF A RIDE

 SEAKEEPER
RIDE

RIDE.SEAKEEPER.COM

3434 HANCOCK BRIDGE PKWY | FORT MYERS, FL 33903 | 410.326.1590

THEY SAY
HISTORY REPEATS ITSELF.



WE **DRASTICALLY**
CHANGED THE BOATING EXPERIENCE ONCE, AND
WE'RE DOING IT AGAIN.

**THROW EVERYTHING YOU KNOW
ABOUT TRANSOM-MOUNTED SYSTEMS AWAY.**

NOW,
IMAGINE **BOATING WITHOUT SLAMMING.**

IT'S THE SWITCH FROM STICK SHIFT
TO AN AUTOMATIC TRANSMISSION.

WE'RE ABOUT TO
**KNOCK YOUR
BOAT
SHOES OFF.**

YOU THOUGHT YOU
KNEW BOATING, **BUT
YOU'RE IN FOR**

**ONE OF THE HELL
OF A RIDE.**

A small image of a speedboat moving across the water, leaving a wake, positioned diagonally across the bottom right of the advertisement.

A CATEGORY OF ITS OWN

Inspired by advanced aerospace technology to control pitch, roll, and yaw, Seakeeper Ride is the first and only Vessel Attitude Control System (VACS).

Eliminate up to 70% of underway pitch and roll. It's intuitive. It's automatic. It's transformational.



Seakeeper Ride 450 is standard equipment on the Sportsman Open 232 Center Console

THE FIRST AND ONLY
VESSEL ATTITUDE CONTROL SYSTEM

WAVES COME
AT YOU **FAST.**

TO ELIMINATE MOTIONS,

WE HAD
TO BE **FASTER.**

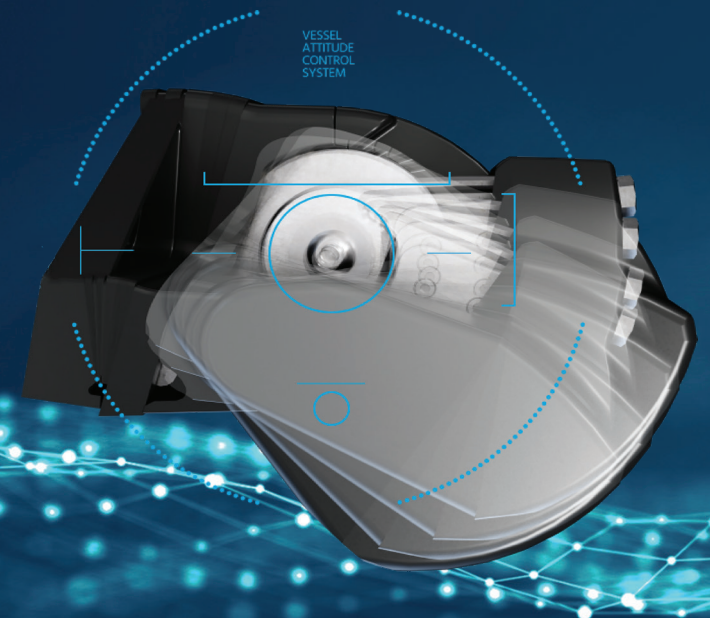

THE NEED FOR SPEED

Wave motions are often unpredictable and ever-changing, occurring in just milliseconds. It took expert control software and hardware to compete.

Seakeeper Ride's sensors take **1,000 measurements** and its proprietary rotary blades make **100 adjustments** **EVERY SECOND** to combat wave motions.

IT DOES WHAT?

Seakeeper Ride eliminates up to 70% of underway pitch and roll motions that often cause the boat to slam - without ever touching a button.

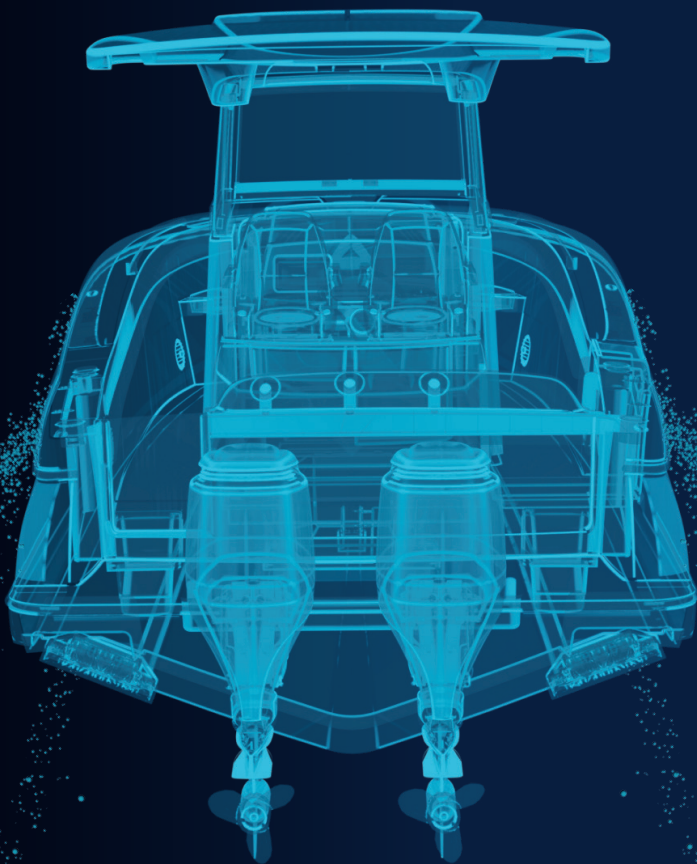

BUT THAT'S NOT ALL...

LIST/LEVEL CONTROL

Never allows vessel list from movement onboard, wind, uneven load while underway, and/or prop torque



AUTOTRIM

Customized Trim Command Curve automatically adjusts the boat to match the optimal running angle at any given speed

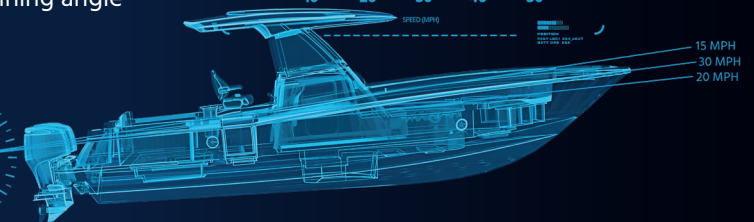
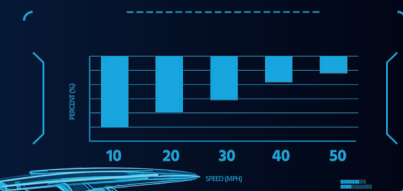

SIGHT LINE

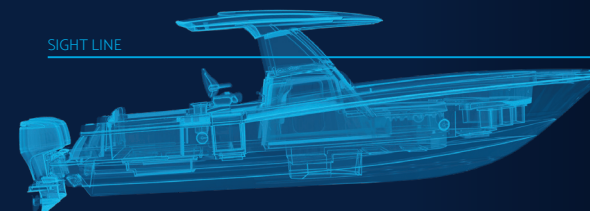

HOLESHOT

Optimized to allow for faster acceleration, getting the boat on plane more quickly and improving fuel economy during the transition to planing

COORDINATED TURN

Automatically adjusts the heeling angle of your boat during turns for more comfort, increased safety, and better performance at any given speed

THE SEAKEEPER RIDE DIFFERENCE

RAPID ACTUATION

Rotary blades deploy at a rate of up to 300 mm per second, enabled by a power-dense rotary design that requires just 7-10 Amps for operation

FULL UNDERWAY CONTROL

Controls all motions (pitch, roll, yaw) thanks to deployment speed and proprietary control software and hardware

INTUITIVE

Predicts motion and responds automatically and instantaneously to eliminate them before they're felt with no manual adjustments needed

RELIABLE

Drivetrain is completely sealed in a dry and greased environment with no mechanical exposure to saltwater

SIMPLE INSTALLATION

Easily installed on most transoms

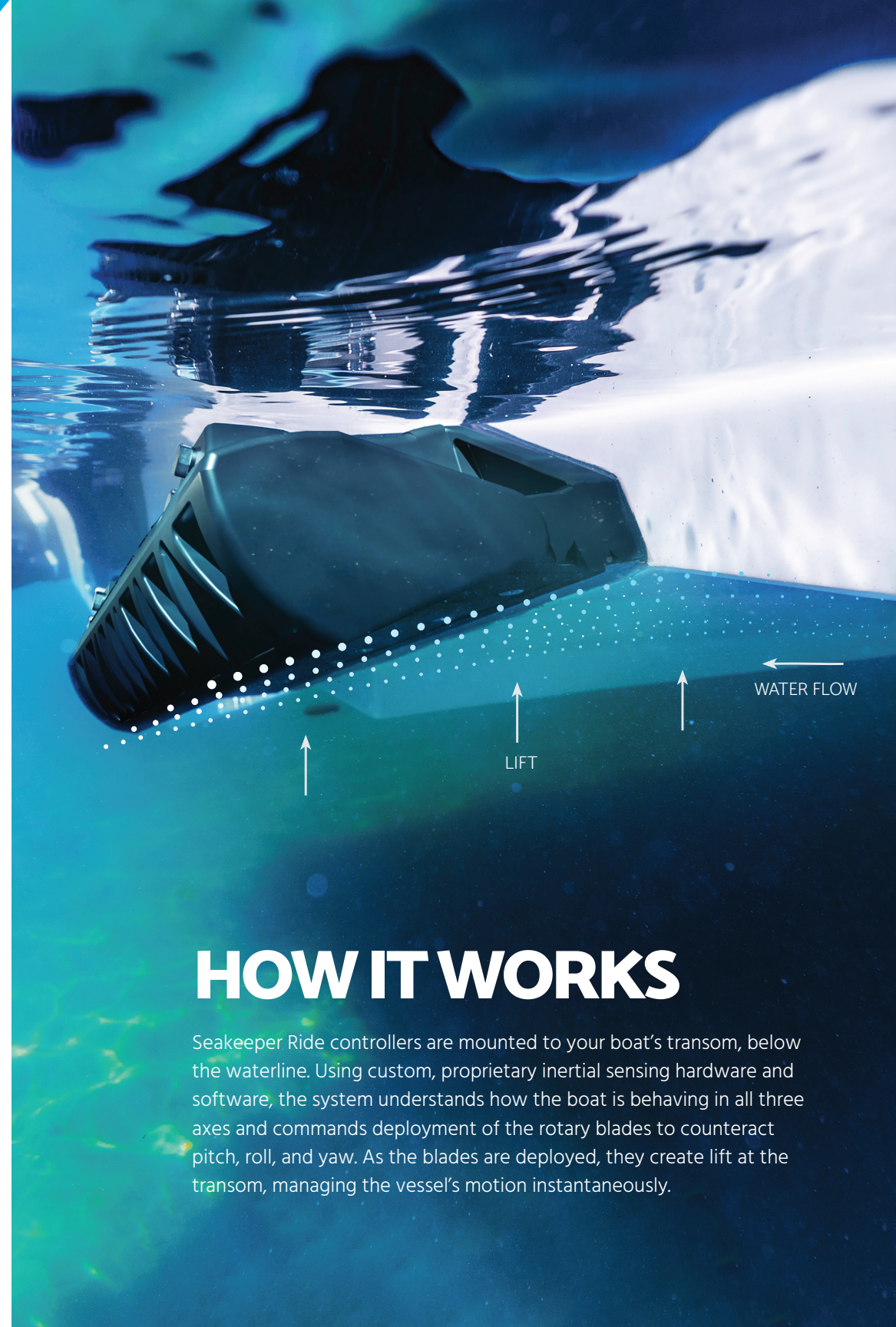

HOW IT WORKS

Seakeeper Ride controllers are mounted to your boat's transom, below the waterline. Using custom, proprietary inertial sensing hardware and software, the system understands how the boat is behaving in all three axes and commands deployment of the rotary blades to counteract pitch, roll, and yaw. As the blades are deployed, they create lift at the transom, managing the vessel's motion instantaneously.



UP TO
70%
PITCH & ROLL
ELIMINATED

PROVE IT

Claims of pitch and roll elimination are nothing without the backing of real, measurable results, so we've created a library of data to prove it.

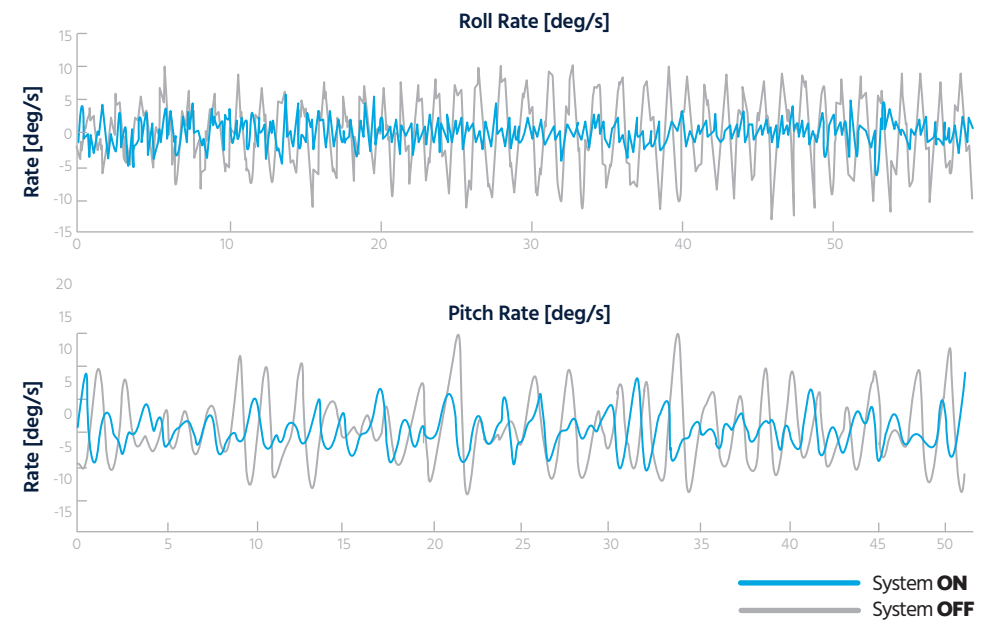

Visit ride.seakeeper.com/performance to see our full library of performance reports.

Seakeeper Ride 525 is standard equipment on the Chris-Craft Catalina 30

PRODUCTS



SEAKEEPER RIDE 450

For Boats Up to 26 ft
Blade Size 450 mm (~18 in.)
Power Draw 12V 7-8 Amps @ Cruising Speeds
Retail Price \$4,500



SEAKEEPER RIDE 525

For Boats 27 - 30 ft
Blade Size 525 mm (~21 in.)
Power Draw 12V 7-8 Amps @ Cruising Speeds
Retail Price \$7,500



SEAKEEPER RIDE 600

For Boats 31 - 35 ft
Blade Size 600 mm (~24 in.)
Power Draw 12V 7-8 Amps @ Cruising Speeds
Retail Price \$10,500

KEEP IT SIMPLE

Manually adjusting trim and list from a keypad is so last year. High tech doesn't have to mean extra difficult. Seakeeper Ride is completely automatic with no manual keypad adjustments needed. Just turn the key and enjoy the ride.



COMPONENTS

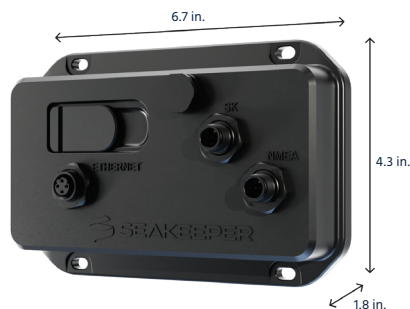

SOFTWARE MODULE

The “brain” of the system that includes Seakeeper Ride’s proprietary software and motion sensor



DISTRIBUTION MODULE

Provides power and communication between the controllers and the software module



USER INTERFACE

Compatible with select models from Garmin, Raymarine, Simrad, Navico, Lowrance, B&G, and Furuno

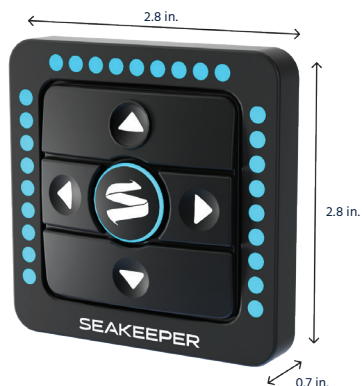

KEYPAD (OPTIONAL)

Physical, mountable keypad that can be used for manual adjustments outside the MFD application

HOW TO BUY



REFITS

Learn more about refitting the boat you have and love with Seakeeper Ride.

ride.seakeeper.com/refits

NEW BOATS

Seakeeper Ride is available as standard equipment on select boat models.

ride.seakeeper.com/how-to-buy

Seakeeper Ride 525 is standard equipment on the Scout 305 LXF

CONTROLLER CARE

Seakeeper Ride's maintenance is minimal. As with most boating accessories, you should use fresh water to rinse the controllers after use or each time the boat is removed from saltwater.

ZINCS

The actuators on each controller have zincs that need to be periodically inspected and replaced when about half of the anode has worn down. Zincs can be purchased through Seakeeper.

BOTTOM PAINT

Bottom paint is recommended for systems that will be submerged for more than two weeks at a time.

MARINE GROWTH

A pressure washer or mild marine soap and a scrub brush can be used to remove pesky marine growth.

See more controller care instructions at ride.seakeeper.com/support

WARRANTY

Each Seakeeper Ride system comes with a 2-year standard warranty, so rest assured, we've got you covered.

See warranty details at ride.seakeeper.com/warranty



WE'RE JUST GETTING STARTED

So, let's keep in touch!
Join our email list:

 SEAKEEPER
RIDE



 @seakeeper.ride

 facebook.com/seakeeperride

 seakeeper

#seakeeperride