

XPLORE™ SERIES

» FISH FINDERS

Easy Access to Epic Fishing Days

With stunning HD – and unmatched clarity and imaging options – the new XPLORE™ Series makes every fish as clear as day. No guessing, just catching. Featuring a smarter, faster and easier-to-use interface. A new waypoint management system. And quick access to everything through a lightning-fast touchscreen, plus shortcuts for your favorite tools and technologies. Find your fishing spots efficiently with LakeMaster® and CoastMaster® charts included.* Connect instantly to Minn Kota® products – from advanced GPS navigation to shallow water anchors – with One-Boat Network® compatibility. Experience fishing faster than ever before.



FEATURES	
DISPLAY FEATURES	SONAR CAPABILITY
High-Def Display	MEGA Live 2
Engineered for Polarized Eyewear	MEGA Live Imaging®
	MEGA 360 Imaging®
FISH FINDER FUNCTIONALITY	DUAL SPECTRUM CHIRP SONAR
Intuitive Cross Touch®	Full: 150-220 kHz @ 25/42o
Quick-Launch Home Screen	Narrow: 180-240 kHz @ 25o
	Wide: 140-200 kHz @ 42o
CONNECTIVITY	SONAR
CE	MEGA Side Imaging+®
NMEA 2000®	Range:
Bluetooth®	800ft (244m) 455 kHz: 405-505 kHz
Ethernet	400ft (122m) MEGA: 1100-1200 kHz
Wi-Fi	MEGA Down Imaging+®
MFi	Depth:
	400ft (122m) 455 kHz: 420-520 kHz
	200ft (61m) MEGA: 1125-1225 kHz
INCLUDED IN THE BOX	
XPLORE Fish Finder, Power Cable, Unit Cover, Gimbal Mount with Hardware and Knobs	
CARTOGRAPHY**	
LakeMaster® VX	
CoastMaster® VX	
SmartStrike™	
AutoChart® Live	
PLUG-AND-PLAY MINN KOTA CAPABILITY	
Share waypoints between XPLORE and your phone via the One-Boat Network® App	

MODELS - NORTH AMERICA*		
XPLORE 9		
412000-1	XPLORE 9 CMSI+	UPC: 0-82324-05865-3
412000-1CHO	XPLORE 9 CHO	UPC: 0-82324-05866-0
XPLORE 10		
412010-1	XPLORE 10 CMSI+	UPC: 0-82324-05867-7
412010-1CHO	XPLORE 10 CHO	UPC: 0-82324-05868-4
XPLORE 12		
412020-1	XPLORE 12 CMSI+	UPC: 0-82324-05869-1
412020-1CHO	XPLORE 12 CHO	UPC: 0-82324-05870-7
MODELS - INTERNATIONAL		
XPLORE 9		
412000-1M	XPLORE 9X CMSI+	UPC: 0-82324-05972-8
412000-1MCHO	XPLORE 9X CHO	UPC: 0-82324-05971-1
XPLORE 10		
412010-1M	XPLORE 10X CMSI+	UPC: 0-82324-05968-1
412010-1MCHO	XPLORE 10X CHO	UPC: 0-82324-05967-4
XPLORE 12		
412020-1M	XPLORE 12X CMSI+	UPC: 0-82324-05970-4
412020-1MCHO	XPLORE 12X CHO	UPC: 0-82324-05969-8
WARRANTY		
2-Year Limited Warranty***		

*LakeMaster and CoastMaster card included for models sold in North America only.

**CARTOGRAPHY applicable to fish finders sold in North America only. Includes US Coastal and North American Standard data.

***Extend warranty from two to three years when registering with Humminbird online or in the app.



XPLORE 9

» FISH FINDER

Gimbal Mount

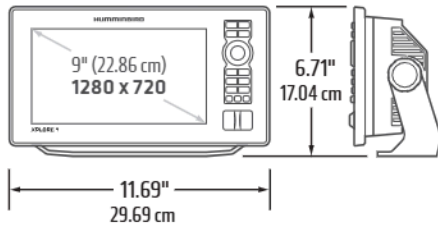

In-Dash Mount

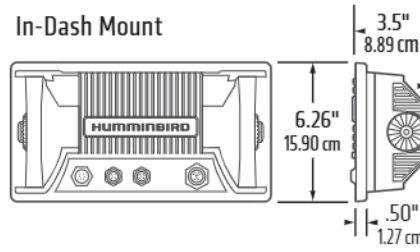

XPLORE 10

» FISH FINDER

Gimbal Mount

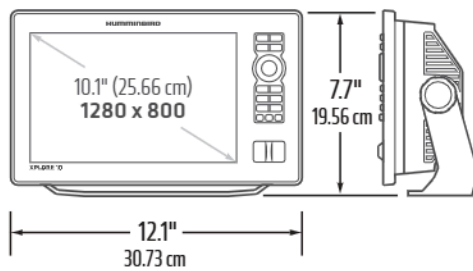

In-Dash Mount

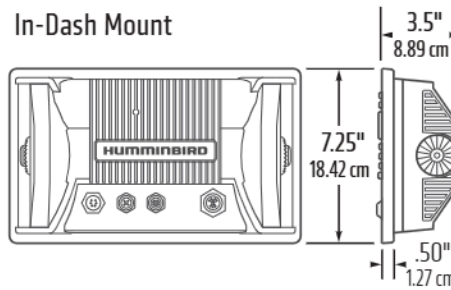

XPLORE 12

» FISH FINDER

Gimbal Mount

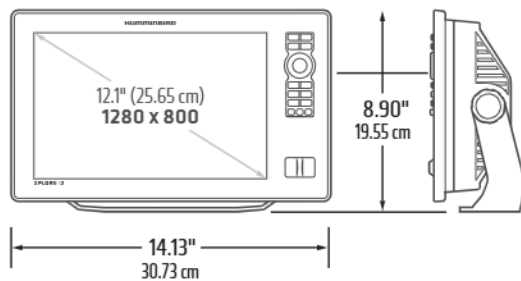

In-Dash Mount

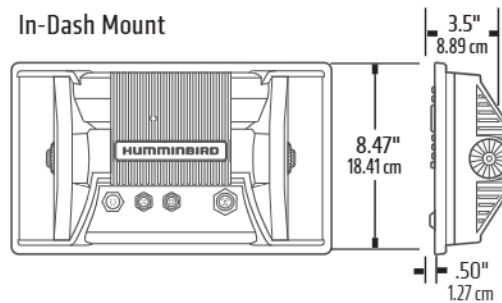

Control Head Ports

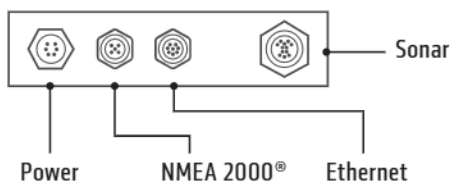

POWER OUTPUT

4,000 W (8,000 W^{***}) Peak-to-Peak
500 W (1,000 W^{***}) RMS

Optional HW MSI+ transducer available for increased depth and range capabilities.

***To obtain 1,000 watts, optional deepwater transducer is required.

