

FURUNO®

THE WORLDS OF COMPUTER
TECHNOLOGY AND
MARINE ELECTRONICS
HAVE FINALLY MERGED...
NOW IT'S TIME TO GET
PLUGGED IN!



NAVnet®



The future today with FURUNO's electronics technology.

FURUNO ELECTRIC CO., LTD.

9-52 Ashihara-cho, Nishinomiya City, Japan Phone: +81 (0)798 65-2111

Fax: +81 (0)798 65-4200, 66-4622 URL: www.furuno.co.jp

Catalogue No. R-180h

TRADE MARK REGISTERED
MARCA REGISTRADA



THE FUTURE OF MARINE ELECTRONICS IS HERE!

Welcome to the future of marine electronics! Introducing NavNet, Furuno's new line of Ethernet networked products. NavNet gives you the capability to communicate from one display to another over Furuno's High Speed Network.

THE **NAVnet** NETWORK

The heart of Furuno's NavNet is its Ethernet based network. Using today's technology, NavNet runs on a 10Base-T network, which means fast data transfer between your equipment. And because Ethernet offers the option to increase speeds from 10 Megabits per second all the way to 1 Gigabit per second, NavNet's future expansion is limitless!

WHAT WILL **NAVnet** DO FOR ME?

NavNet products will allow you to customize your marine electronics according to what you need. From a standard Radar & VideoPlotter unit, you can add on a WAAS/GPS, Fish Finder, Weather Facsimile and even multiple displays. When multiple displays are connected, you can operate each display as an individual product or as part of the network. With more than 50 different display modes, NavNet can display the information you care the most about, the way you want to see it.

- Perfect for single or multiple display installations
- All display units are capable of controlling any component connected to the NavNet network
- Common interface on all four models of the NavNet products shortens training time
- Over 50 display modes to choose from when all components are active
- Simplified cabling requirements

THE **NAVnet** INTERFACE

Furuno's Research & Development engineers have spent countless hours making the NavNet products extremely easy and intuitive to use. The straightforward menu structure is easily selected through the softkeys and the standardized control philosophy ensures simple operation of the Radar, WAAS/GPS VideoPlotter, Fish Finder and Weather Facsimile. The controls are exactly the same from one unit to the other, so once you know one, you'll know them all.

THE **NAVnet** EXPANDABILITY FACTOR

Furuno's NavNet keeps future expansion in mind by allowing you to add on multiple units. You can turn a single display system into a multiple display system by simply adding an Ethernet hub. The Hub will allow the products to talk to each other and share information through a simple cable. You can even connect your PC to a NavNet Display, allowing you to download or upload waypoints and routes.

NAVnet SUPPORT AND SERVICE

With Furuno sales and service centers on six continents – plus continental service centers in the United States, Denmark and Japan – the Furuno NavNet products support and service spans the globe.

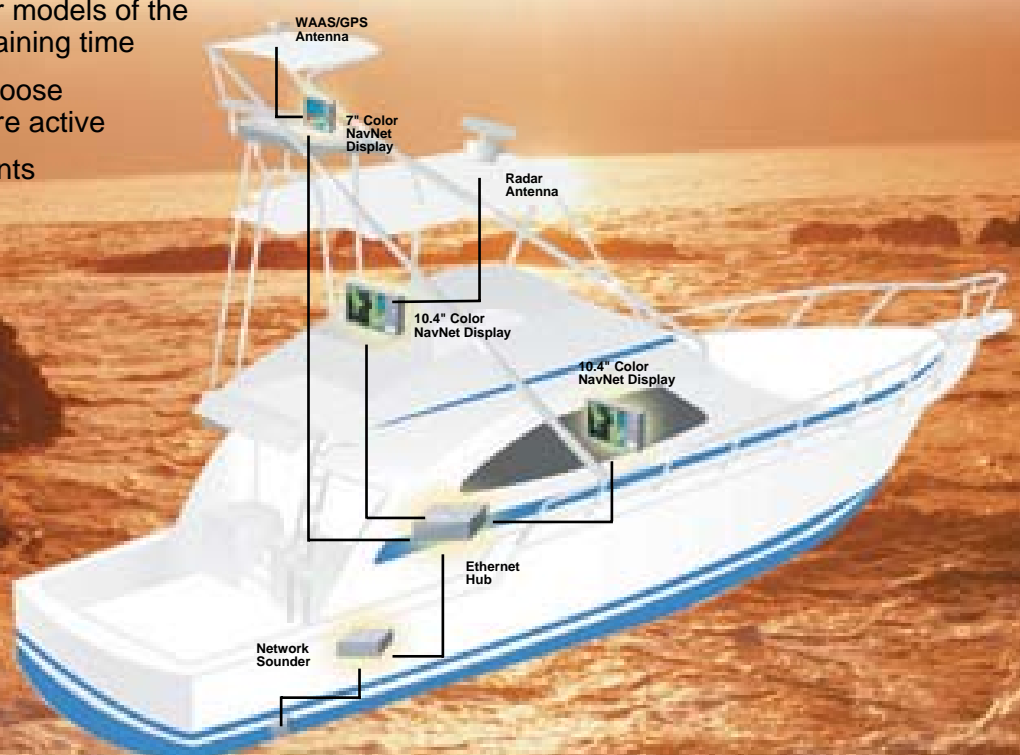

HIGH-SPEED LAN NETWORK MAKING COMPLEX INSTALLATIONS SIMPLE

Multiple NavNet Components can be connected using Ethernet. Each unit becomes a universal display, allowing you to access any component that is connected.

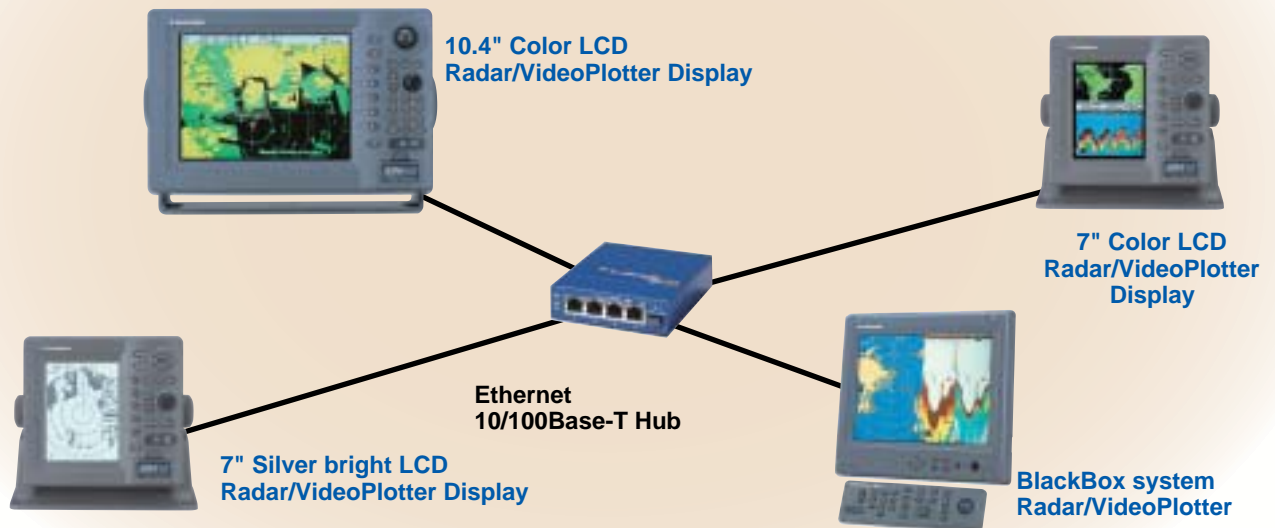

Furuno's NavNet products give you the flexibility to use them as a single, stand-alone system or as part of an integrated network bridge. Using the same network technology seen in modern office environments, the NavNet network utilizes an Ethernet Hub, providing virtually limitless expandability.

The current network allows you to have up to four NavNet displays connected simultaneously. Add a WAAS/GPS receiver antenna, a Network Sounder and a Network Weather facsimile and you will

have a complete electronics package.

But integration doesn't stop there! You can connect multiple radar and WAAS/GPS antennas if needed. The NavNet network will allow you to view any component on any of the NavNet displays. So if you want to have multiple displays on one bridge or individual displays throughout the vessel, you will be able to fully operate every component connected to the NavNet network.

Navigational Data Organizer Remote Display RD-30



- Easily connects to NavNet display via NMEA cable
- Optional Smart Sensor™ integrates a 235 kHz depth transducer, paddlewheel and thermosensor (0.02°F or 0.01°C resolution) which is available in a variety of housings
- High frequency transducer is free from surface clutter and wakes, giving excellent performance at high speed and in shallow water
- Own ship position, speed, course, water temperature, depth, speed and direction of current and wind are displayed on any display units in the network

Note: All displays require appropriate sensors or external input.

12", 15" Sun Light Viewable MULTI-PURPOSE MARINE LCD DISPLAY Models MU-120C/155C

- Crystal clear 12" and 15" monitors for use as main or remote displays
- Built-in scaler allows monitors to accept up to SXGA (1280 x 1024) resolution
- Waterproof, low profile unit allows for flush mount installation
- Wide range of inputs: 2 RGB analog, 1 Digital Video Interface (DVI) and 3 NTSC/PAL
- Unique programmable video input names
 - PIP function allows for displaying two images on the screen at the same time
 - Easily control display with standard infrared remote



Color Radar / VideoPlotter



10.4" Color LCD Radar/VideoPlotter

MODEL 1823C	0.125 to 24 nm, 2.2 kW, 18" Radome
MODEL 1833C	0.125 to 36 nm, 4 kW, 24" Radome
MODEL 1933C	0.125 to 48 nm, 4 kW, 3.5' Open Array
MODEL 1943C	0.125 to 64 nm, 6 kW, 4' Open Array
MODEL 1953C	0.125 to 72 nm, 12 kW, 4' 6" Open Array



Radar Antenna



7" Color LCD Radar/VideoPlotter

MODEL 1723C	0.125 to 24 nm, 2.2 kW, 18" Radome
MODEL 1733C	0.125 to 36 nm, 4 kW, 24" Radome
MODEL 1753C	0.125 to 36 nm, 4 kW, 2' Open Array
MODEL 1763C	0.125 to 48 nm, 4 kW, 3.5' Open Array

When it comes to desirable features, user interface and screen definition, the 10.4" Color LCD NavNet Radar/VideoPlotter is the cream of the crop. This rugged, waterproof and compact unit offers professional features that meet the needs of serious mariners.

Furuno's 10.4" NavNet Radars were engineered around powerful X-Band transmitters that cut through all types of weather. They are packed with high-speed processors that help you identify what's out there.

As with its big brother, the 7" NavNet Display's crystal clear VGA LCD is capable of showing a variety of display configurations to suit your needs. Each display comes standard as a Radar and VideoPlotter; optionally, you can add a Network Sounder and WAAS/GPS.

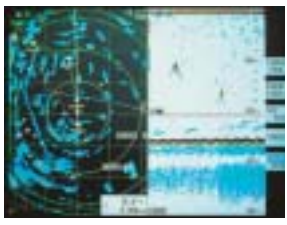

Radar/Fish Finder

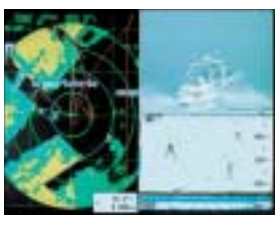

Radar Overlay*/Video/Fish Finder

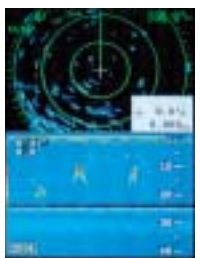

Radar/Fish Finder

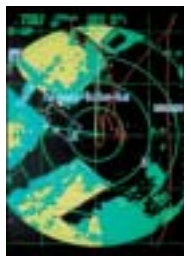

Radar Overlay*

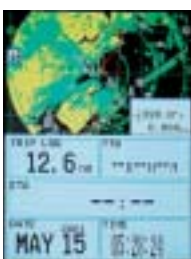

Radar Overlay*/Nav Data

*Required appropriate heading sensor.

NavNet Displays offer more flexibility than any other product on the market. With more than 50 possible display combinations selected through Furuno's exclusive NavNet menus, you are sure to find a display mode to suit your needs. If that weren't enough, there are five user programmable modes (six for 10.4" LCD) to allow you to customize your favorite displays with just a few key strokes.



Six User Programmable Modes (10.4" LCD model)

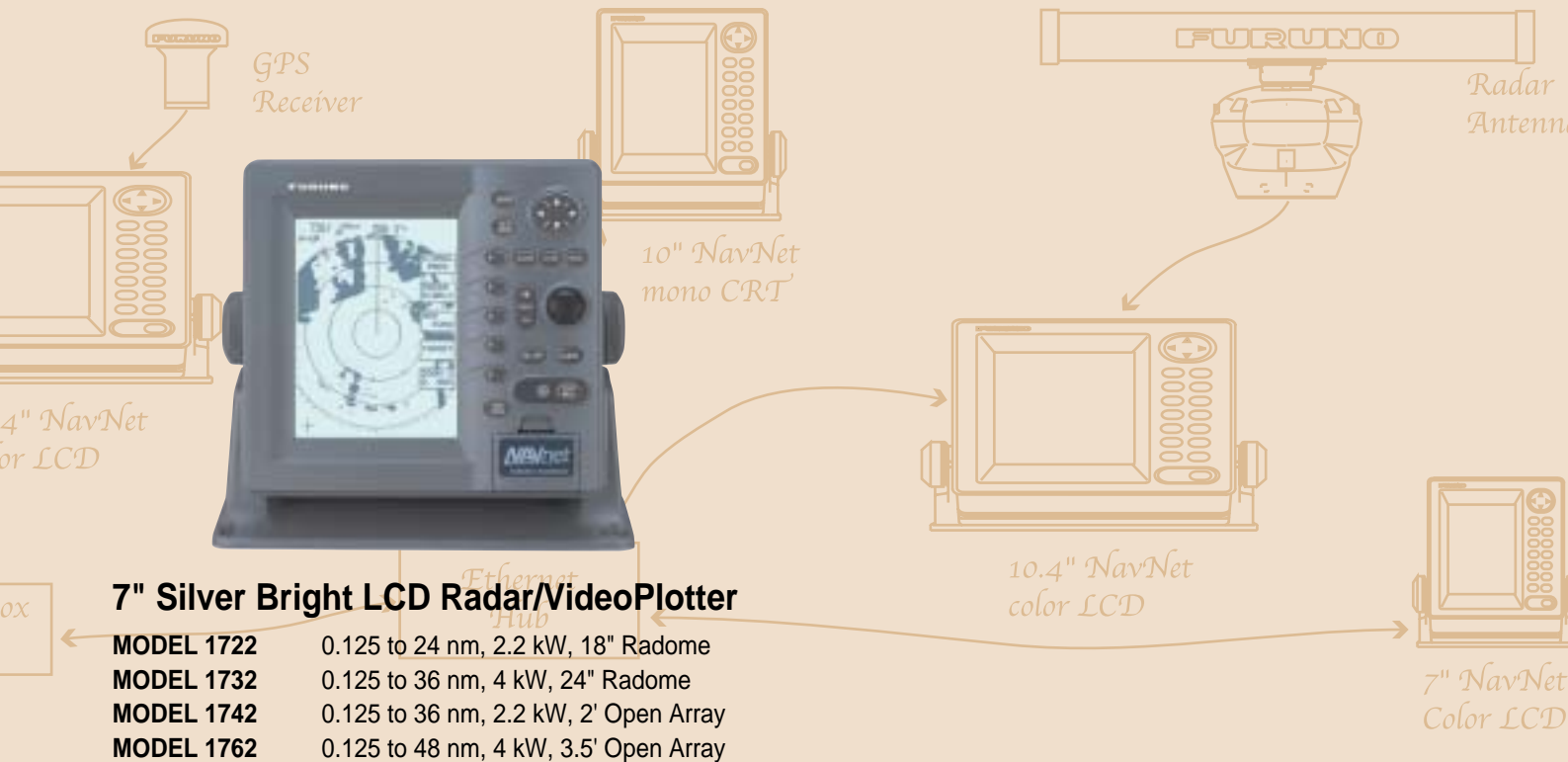

Note: Part numbers listed above are for Navionics Version.
Add "NT" at the end of any part number order a C-MapNT version.

If you want powerful, vivid performance, but don't have a lot of space, the 7" NavNet series is for you. These waterproof units are some of the most compact LCD displays we've ever offered with these features. Smaller in size, but similar in features, the 7" NavNet series has followed in its big brother's footsteps.

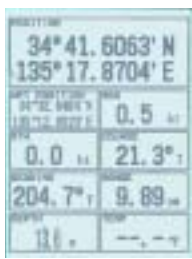

7" Monochrome Nav Data display



7" Monochrome Radar/Fish Finder



Each NavNet, excluding BlackBox, comes standard with an infrared remote controller. This fully functional controller allows you to operate every mode of the NavNet unit without having to access the display unit.

- Special Anti-Reflective coating on display (7" and 10.4" color LCDs only)
- VGA LCD provides crisp and clear images for high quality presentations in any modes
- Over 50 different display modes to choose from when connected with optional WAAS/GPS and Network Sounder
- Choose from two types that accept either Furuno and Navionics® or C-MapNT mini chart cards
- Store up to 8,000 points for ship's track and marks, 999 waypoints and 200 planned routes
- Vertical split screen allows for two display modes to be displayed simultaneously (7" LCD)
- Display VideoPlotter and Radar side by side (all units), or overlay* Radar image on chart (color units) * Requires appropriate heading sensor
- Dual EBLs (Electronic Bearing Lines) and dual VRMs (Variable Range Markers) give distance and bearing to targets
- Optional NTSC/PAL interface allows for TV/VCR/DVD video input on the 10.4" LCD (standard on BlackBox models)
- RGB video output available on 10.4" LCD (Not available on BlackBox models)
- Radar Guard Zone and Watchman features help to alert you to potential danger
- Four radar display modes: Head-up, North-up, Course-up and True Motion

Mono Radar / VideoPlotter

VideoPlotter

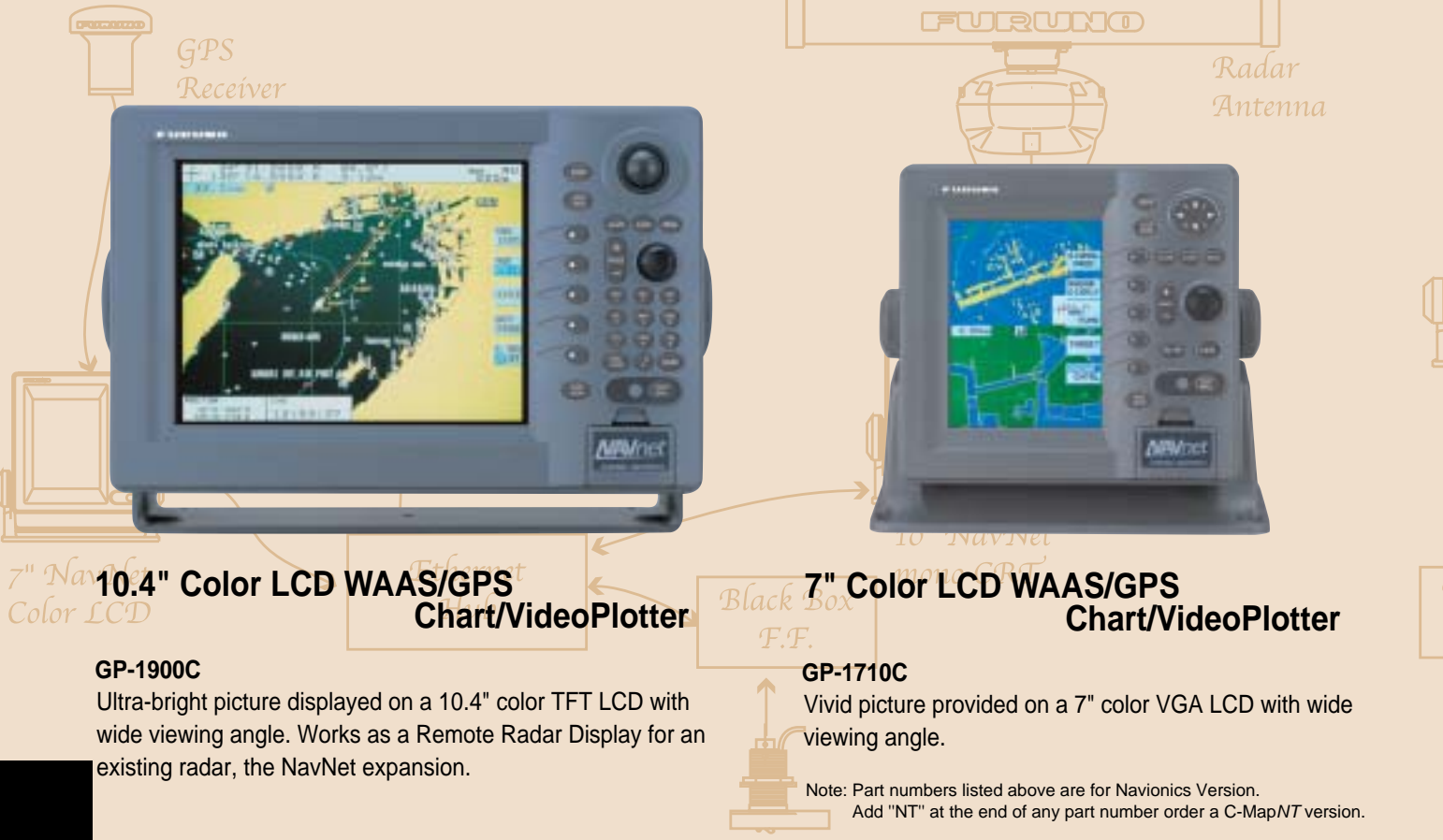

10.4" Color LCD WAAS/GPS Chart/VideoPlotter

GP-1900C
 Ultra-bright picture displayed on a 10.4" color TFT LCD with wide viewing angle. Works as a Remote Radar Display for an existing radar, the NavNet expansion.

7" Color LCD WAAS/GPS Chart/VideoPlotter

GP-1710C
 Vivid picture provided on a 7" color VGA LCD with wide viewing angle.

Note: Part numbers listed above are for Navionics Version. Add "NT" at the end of any part number order a C-MapNT version.

- Special Anti-Reflective coating on display (7" and 10.4" color LCDs only)
- VGA LCD provides crisp and clear images for high quality presentations in any modes
- Over 50 different display modes to choose from when connected with optional Radar and Network Sounder
- Display modes in various configurations, including dual or tri-split screens (10.4" LCD)
- Versatile display modes including: Course Plot, Alphanumerical Nav Data, Steering and 3-D Highway modes
- Choose from two types that accept either Furuno and Navionics® or C-MapNT mini chart cards
- Store up to 8,000 points for ship's track and marks, 1,000 waypoints and 200 planned routes
- Selectable background colors, including high-contrast white (on color displays)
- Optional NTSC/PAL interface allows for TV/VCR/DVD video input on the 10.4" LCD (standard on BlackBox models)
- RGB video output available on 10.4" LCD (Not available on BlackBox models)

If a WAAS/GPS VideoPlotter is what you need to complete your bridge, Furuno's NavNet GPS/VideoPlotter has all the features you are searching for in a 10.4" color or 7" color LCD display.

All of the NavNet products are capable of being networked through a standard Ethernet Hub. Simply plug all of the various NavNet components into the Hub, then you can share information from one display to another.



Plotter/Radar/ Highway



Nav Data/Radar/ Plotter



Nav Data/Fish Finder/Highway

New



BlackBox Radar/VideoPlotter

MODEL 1823C-BB	0.125 to 24 nm, 2.2 kW, 18" Radome
MODEL 1833C-BB	0.125 to 36 nm, 4 kW, 24" Radome
MODEL 1933C-BB	0.125 to 48 nm, 4 kW, 3.5' Open Array
MODEL 1943C-BB	0.125 to 64 nm, 6 kW, 4' Open Array
MODEL 1953C-BB	0.125 to 72 nm, 12 kW, 4'/6' Open Array

BlackBox WAAS/GPS Chart/VideoPlotter GP-1900C-BB

Note: Part numbers listed above are for Navionics Version. Add "NT" at the end of any part number order a C-MapNT version.

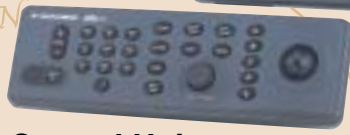

Control Unit

MU-120C



Processor Unit



Chart card slot

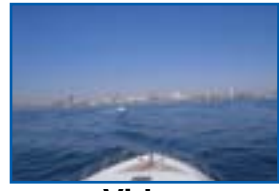

Video

For those who would like to utilize a large external monitor with NavNet, Furuno now offers the NavNet BlackBox series. The BlackBox series (Models 18x3C-BB/19x3C-BB and GP-1900C-BB) allows you the flexibility to choose virtually any type and size display, as long as it is a multi-sync PC monitor that supports VGA input. Each NavNet BlackBox system includes an antenna, processor and control unit that is based on the original Furuno NavNet series.

The processor unit comes with a built-in NTSC/PAL video interface, allowing you to display external video from a camera, DVD, etc., in addition to the radar, sounder and plotter information. The control unit is compact and waterproof, making it perfect for mounting at any helm, even an open fly bridge.

The operation and functions of the NavNet BlackBox are identical to the original NavNet. So you can have a network containing an original NavNet display with a NavNet BlackBox and they will work the same. This reduces the learning curve, because once you know how to operate one, you will know how to operate them all.

- Connect with multi-sync VGA monitor
- Compact keyboard has same key structure as all of the NavNet series (Operations/functions are based on the NavNet 10.4" displays)
- Standard NTSC/PAL video interface



USER-FRIENDLY INTERFACE

A common user interface and control panel is used on all of the NavNet products. This ensures that no matter which model you are using, when you connect another display, it will work exactly the same. The 10.4" Color LCD and BlackBox units come with a bonus ten-key keypad to make entering waypoints, routes and other information even easier.

NavNet Displays offer more flexibility than any other product on the market. With more than 50 possible display combinations selected through Furuno's exclusive NavNet menus, you are sure to find a display mode to suit your needs. If that weren't enough, there are five user programmable modes to allow you to customize your favorite displays with just a few key strokes.



BlackBox

WAAS/GPS RECEIVER ANTENNA



GP-320B

Make any NavNet product capable of receiving WAAS and GPS information by simply adding this receiver antenna. This WAAS/GPS receiver antenna has everything you need.

The antenna provides accurate and reliable position fixing; GPS 10 m, WAAS 3 m. Simply connect the antenna to any NavNet display and you can display WAAS/GPS information on one display to the entire NavNet network.

* WAAS (Wide Area Augmentation System) is one of the Satellite Based Augmentation systems (SBAS). There are three different SBASs: WAAS in USA, EGNOS in Europe and MSAS in Japan. These three systems are developed to be interoperable and fully compatible. (further information: please refer to the specifications)

CARTOGRAPHY OPTIONS



FURUNO MINI CHART CARD

Furuno's NavNet products give you the power to choose what type of charts you want to use for the plotter. You can choose from two types that accept either FURUNO CDC and Navionics® or C-MapNT mini-chart cards. Specify which charting system you prefer to use when you place your order. All cards are front loaded to allow for flush mounting of the display units.



WAAS

(Wide Area Augmentation System)

WAAS is a GPS navigation system with a differential correction by means of geostationary satellites. The US FAA has been testing this system throughout 2003 and more field tests are expected. Similar systems, using Satellite-Based Augmentation Systems (SBAS), are under development in Japan (MSAS: MSAT Satellite-based Augmentation System) and Europe (EGNOS: European Geostationary Navigation Overlay System). They are said to be fully interoperable and compatible. MSAS and EGNOS are expected to become fully operated in 2004 or after.

As the WAAS utilizes the same frequency as the GPS, a single antenna can receive GPS and WAAS signals. Currently two Inmarsat GEO satellites are available, i.e., AOR-W and POR. Major contributors of an error in a single frequency GPS system is receiver clock drift and signal delays by refraction. The WAAS reference stations on the earth monitor the GPS constellation and route GPS error data to the satellites via the master earth station. The Inmarsat or communication satellite broadcasts the differential corrections to marine and aviation users.

NETWORK SOUNDERS



ETR-6/10N

Frequency: Dual-frequency, 50 kHz and 200 kHz
 Output power: 600 W/1 kW rms
 Basic range: Any ranges customizable between 2 m and 1200 m



ETR-30N

Frequency: Dual-frequency, Select two from 28/38/50/88/107/200 kHz
 Output power: 1/2/3 kW rms
 Basic range: Any ranges customizable between 2 m and 1500 m

The Network sounders are sensors that plug into any NavNet display or into a Hub for multi-display installations. The sensors turn any NavNet Display into a high-performance sounder. The ETR-6/10N is a dual-frequency 50/200 kHz, 600 W or 1 kW sounder. The ETR-30N employs the Furuno Free Synthesizer (FFS) transceiver. It allows the user to select two operating frequencies from 28 to 200 kHz. Output power is also selectable from 1, 2 and 3 kW depending on the transducer used. They incorporate all of the award winning Furuno Sounder features you've grown to depend on, including:

- Variety of presentation modes, including marker zoom, bottom discrimination, bottom lock expansion, A-scope and more
- Audible and adjustable depth and fish alarms
- Choice of feet, fathoms or meters
- Selectable screen background colors, including white
- Automatic Cruising & Fishing modes to meet your style of boating

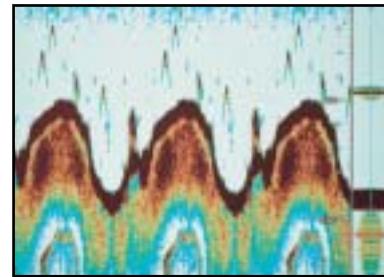

NETWORK WEATHER FACSIMILE



FAX-30



Normal



Reverse

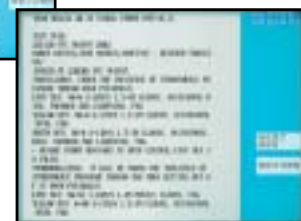

Navtex

The Network Weather facsimile is a BlackBox Facsimile receiver designed to work with 10.4" NavNet display, BB system or PC. It receives weather maps, satellite images, safety messages (NAVTEX) and maritime navigation information.

- Store up to 12 pictures
- 320 user programmed channels
- Noise rejection function for clear image
- Navtex receiver standard. Up to 130 messages can be stored.
- Ability to print images & messages from PC with printer

RADAR ANTENNA SELECTIONS



Each NavNet Radar comes with a durable Furuno antenna. The power output ranges from the sleek 2.2 kW radome, to the powerful 12 kW open array. There is a radar and antenna type for any situation. Please refer to the specifications page for a complete listing of beam width, TX output power and range scales.

Standard configuration (with standard LCD monitor)

Single Display System

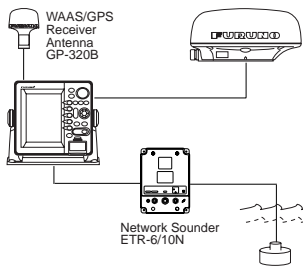

Single Display System

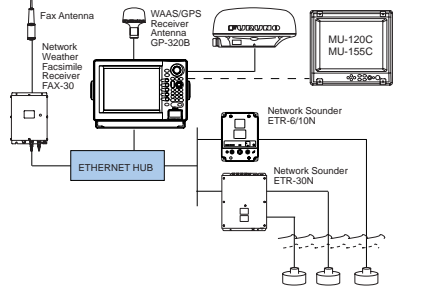

Dual Display System

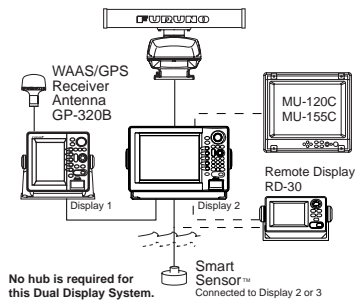

Multiple Display System 1

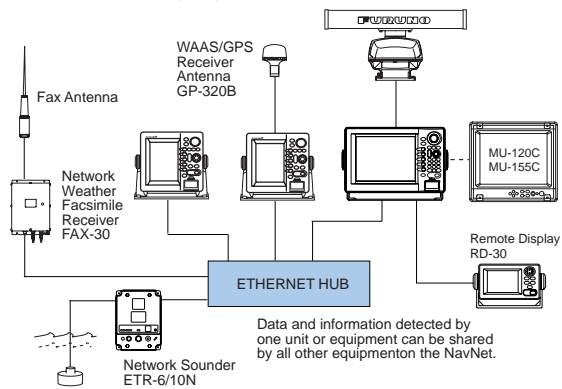

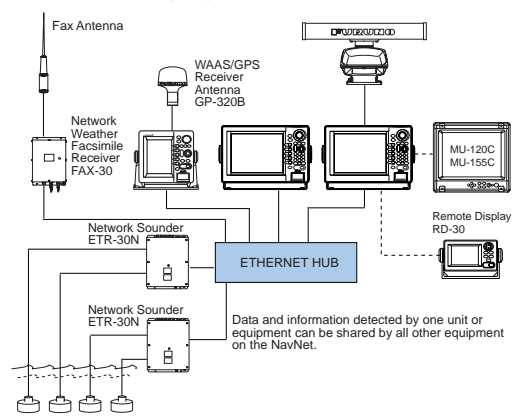

Multiple Display System 2

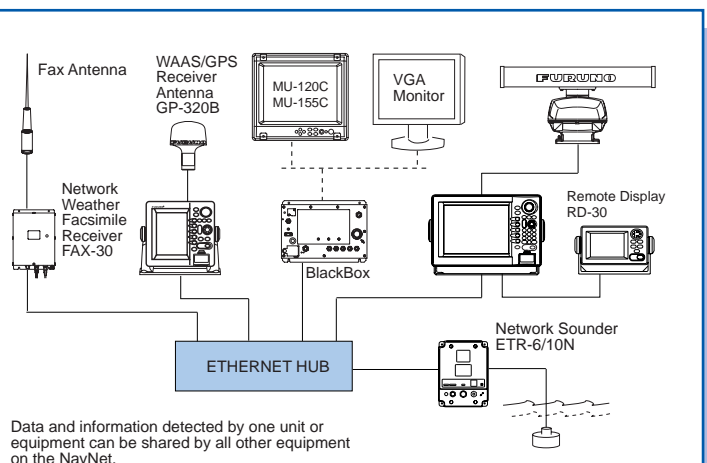
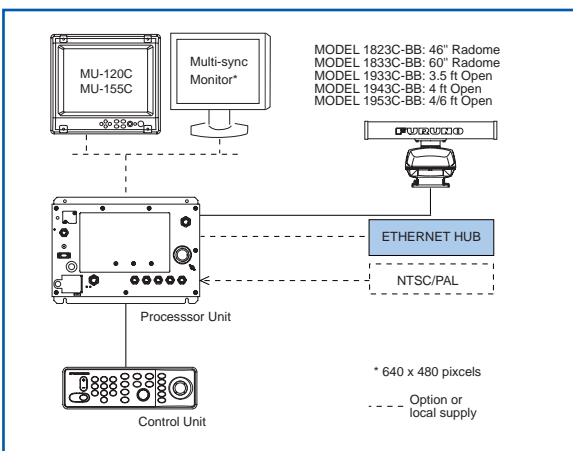

BlackBox configuration (with custom monitor)



SPECIFICATIONS OF NavNet SERIES

	7" Monochrome Radar / VideoPlotter				7" Color Radar / VideoPlotter			
	MODEL 1722	MODEL 1732	MODEL 1742	MODEL 1762	MODEL 1723C	MODEL 1733C	MODEL 1753C	MODEL 1763C
								
DISPLAY UNIT								
1. Type	7" Monochrome STN LCD, 240 x 320 pixels				7" Color VGA LCD, 480 x 640 pixels			
2. NavNet Interface	Ethernet 10Base-T							
3. Interface (NMEA 0183 format)	Input: BWC, BWR, DBT, DPT, GGA, GLL, GSV, HDT, HDM, HDG, MTW, MWV, RMA, RMB, RMC, TTM, VHW, VTG, VYW, VWT, VWR, ZDA Output: AAM, APB, BOD, BWC, BWR, DBT, DPT, GGA, GLL, GTD, HDG, HDT, MTW, MWV, RMA, RMB, RMC, TLL, TTM, VHW, VTG, WPL, XTE, ZDA							
RADAR CHARACTERISTICS								
1. Display Modes	Head-up, Course-up*, North-up*, True Motion** (* Heading input required ** Heading and speed inputs required)							
2. Range Scales (nm)	0.125 to 24 nm 14 steps	0.125 to 36 nm 15 steps	0.125 to 36 nm 15 steps	0.125 to 48 nm 16 steps	0.125 to 24 nm 14 steps	0.125 to 36 nm 15 steps	0.125 to 36 nm 15 steps	0.125 to 48 nm 16 steps
3. Echo Trail	Interval: 15 s, 30 s, 1 min, 3 min, 6 min, 15 min, 30 min or Continuous							
PLOTTER CHARACTERISTICS								
1. Map Scale	0.125 to 1,024 nm							
2. Latitude Limits	Between 85°N and 85°S							
3. Plot Interval	1 s to 59 min 59 s or 0.01 to 9.99 nm							
4. Display Modes	Course plot, Nav data, Steering display, Highway							
5. Presentation Modes	TM/RM North-up, Course-up, Auto Course-up							
6. Memory Capacity	Up to 8,000 points for ship's track and marks 1,000 waypoints 200 planned routes (max. 35 waypoints/route)							
7. Alarms	Guard Zone, Arrival/anchor watch, XTE, proximity alert, ship speed, depth*, water temperature*, fish* (*Network sounder required, temperature sensor required for water temperature alarm)							
8. Electronic Charts*	Loaded from a FURUNO MiniChart, Navionics® Nav-Chart, C-MapNT chart cards * Chart must be determined upon ordering. Choice of two types: Furuno & Navionics® or C-Map							
ANTENNA RADIATOR								
1. Type	Ø460 mm (18") Radome	Ø602 mm (24") Radome	697 mm (2 ft) Open	1035 mm (3.5 ft) Open	Ø460 mm (18") Radome	Ø602 mm (24") Radome	697 mm (2 ft) Open	1035 mm (3.5 ft) Open
2. Rotation Speed	24 rpm	24 rpm	24 rpm	24 rpm	24 rpm	24 rpm	24 rpm	24 rpm
3. Wind Load	Relative 80°/100 kt (*MODEL1752/1752C)							
4. Beamwidth	Hor: 5.2° Vert: 25°	Hor: 3.9° Vert: 20°	Hor: 3.5° Vert: 30°	Hor: 2.2° Vert: 22°	Hor: 5.2° Vert: 25°	Hor: 3.9° Vert: 20°	Hor: 3.5° Vert: 30°	Hor: 2.2° Vert: 22°
RF TRANSCEIVER								
1. Peak Output Power	2.2 kW	4 kW	2.2 kW	4 kW	2.2 kW	4 kW	4 kW	4 kW
2. Frequency	9410 ± 30 MHz (X-Band)							
3. Pulelength & PRR	0.08 µs/2100 Hz (0.125 to 1.5 nm) 0.3 µs/1200 Hz (1.5 to 3 nm) 0.8 µs/600 Hz (3 to 48 nm)							
ENVIRONMENT (IEC 60945 test method)								
Temperature	-15°C to +55°C (Display unit) -25°C to +70°C (Antenna unit)							
Waterproofing	IEC 60529 IPX5, USCG CFR-46 (Display unit) IEC 60529 IPX6 (Antenna unit)							
POWER SUPPLY								
	12-24 VDC Max. 44 W	12-24 VDC Max. 46 W	12-24 VDC Max. 47 W	12-24 VDC Max. 57 W	12-24 VDC Max. 52 W	12-24 VDC Max. 54 W	12-24 VDC Max. 55 W	12-24 VDC Max. 58 W
	115/230 VAC with optional rectifier PR-62 /RU-3423							
Optional unit								
Antenna Bracket	OP03-93	OP03-92	Not Available		OP03-93	OP03-92	Not Available	
10-Target Autoplotter	Full control when networked with 10.4" LCD or 10" CRT and ARP-11							
External Buzzer	OP03-136 or Relay/Contact Closure							
NTSC/PAL Interface Kit	Not Available							

7-inch LCD (Bracket Mount)

3.5 kg 7.7 lb

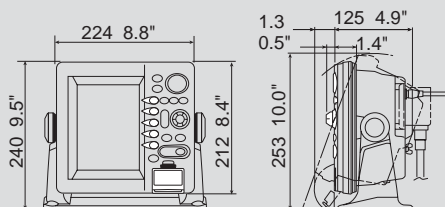

7-inch LCD (Flush Mount)

3.2 kg 7.1 lb

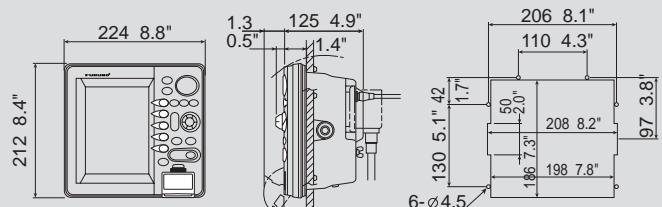

Cutout for Flush Mount

SPECIFICATIONS OF NavNet SERIES

	10.4" Color LCD Radar / VideoPlotter				
	MODEL 1823C	MODEL 1833C	MODEL 1933C	MODEL 1943C	MODEL 1953C
					
DISPLAY UNIT					
1. Type	10.4" Color TFT LCD, 640 x 480 pixels				
2. NavNet Interface	Ethernet 10Base-T				
3. Interface (NMEA 0183 format)	Input: BWC, BWR, DBT, DPT, GGA, GLL, GSV, HDT, HDM, HDG, MTW, MWV, RMA, RMB, RMC, TTM, VHW, VTG, VYW, VWT, VWR, ZDA Output: AAM, APB, BOD, BWC, BWR, DBT, DPT, GGA, GLL, GTD, HDG, HDT, MHW, MSK, MTW, RMA, RMB, RMC, TLL, TTM, VHW, VTG, WPL, XTE, ZDA				
RADAR CHARACTERISTICS					
1. Display Modes	Head-up, Course-up*, North-up*, True Motion** (* Heading input required ** Heading and speed inputs required)				
2. Range Scales (nm)	0.125 to 24 nm 14 steps	0.125 to 36 nm 15 steps	0.125 to 48 nm 16 steps	0.125 to 64 nm 17 steps	0.125 to 72 nm 18 steps
3. Echo Trail	Interval: 15 s, 30 s, 1 min, 3 min, 6 min, 15 min, 30 min or Continuous				
PLOTTER CHARACTERISTICS					
1. Map Scale	0.125 to 2,048 nm				
2. Latitude Limits	Between 85°N and 85°S				
3. Plot Interval	1 s to 59 min 59 s or 0.01 to 9.99 nm				
4. Display Modes	Course plot, Nav data, Steering display, Highway				
5. Presentation Modes	TM/RM North-up, Course-up, Auto Course-up				
6. Memory Capacity	Up to 8,000 points for ship's track and marks 1,000 waypoints 200 planned routes (max. 35 waypoints/route)				
7. Alarms	Guard Zone, Arrival/anchor watch, XTE, proximity alert, ship speed, depth*, water temperature*, fish* (*Network Sounder required, temperature sensor required for water temperature alarm)				
8. Electronic Charts*	Loaded from a FURUNO MiniChart, Navionics® Nav-Chart, C-Map ^{NT} chart cards *Chart must be determined when ordering. Choice of two types: Furuno & Navionics® or C-Map				
ANTENNA RADIATOR					
1. Type	Ø460 mm (18") Radome	Ø602 mm (24") Radome	1035 mm (3.5 ft) Open	1255 mm (4 ft) Open	1795 mm (4/6 ft) Open
2. Rotation Speed * 48 rpm is option.	30 rpm(0.125 to 2 nm), 24 rpm(3 to 24 nm)		24 rpm		24/48* rpm not available in 6 ft
3. Wind Load	Relative 100 kt				Relative wind 100 kt (24 rpm) Relative wind 70 kt (48 rpm)
4. Beamwidth	Hor: 5.2° Vert: 25°	Hor: 3.9° Vert: 20°	Hor: 2.2° Vert: 22°	Hor: 1.9° Vert: 22°	Hor: 1.9/1.2° Vert: 22°
RF TRANSCEIVER					
1. Peak Output Power	2.2 kW	4 kW	4 kW	6 kW	12 kW
2. Frequency	9410 ± 30 MHz (X-Band)				
3. Pulselength & PRR	0.08 µs/2100 Hz (0.125 to 1.5 nm) 0.3 µs/1200 Hz (1.5 to 3 nm) 0.8 µs/600 Hz (3 to 64 nm)				0.08 µs/2100 Hz (0.125 to 1.5 nm) 0.3 µs/1200 Hz (1.5 to 3 nm) 0.8 µs/500 Hz (3 to 72 nm)
ENVIRONMENT (IEC 60945 test method)					
Temperature	-15°C to +55°C (Display unit) -25°C to +70°C (Antenna unit)				
Waterproofing	IEC 60529 IPX5, USCG CFR-46 (Display unit) IEC 60529 IPX6 (Antenna unit)				
POWER SUPPLY					
	12-24 VDC Max. 80 W	12-24 VDC Max. 86 W	12-24 VDC Max. 93 W	12-24 VDC Max. 99 W	12-24 VDC Max. 118/138 W
	115/230 VAC with optional rectifier PR-62/RU-3423				
Power Amp Unit	Not Available				PSU-005
Optional unit					
Antenna Bracket	OP03-93	OP03-92	Not Available		
10-Target Autoplotter	ARP-11* (* Requires appropriate heading sensor)				
External Buzzer	OP03-136 or Relay/Contact Closure				
NTSC/PAL Interface Kit	OP03-175				

10.4-inch LCD (Bracket Mount)

6.0 kg 13.2 lb

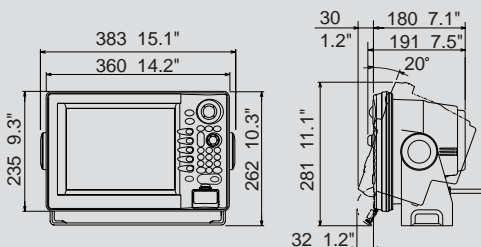

10.4-inch LCD (Flush Mount)

5.2 kg 11.5 lb

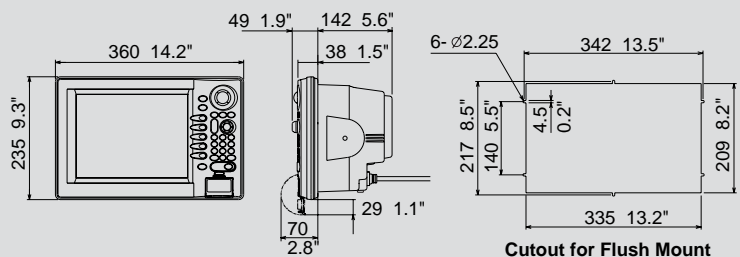

	Radar / VideoPlotter				
	MODEL 1823C-BB	MODEL 1833C-BB	MODEL 1933C-BB	MODEL 1943C-BB	MODEL 1953C-BB
					
DISPLAY UNIT					
1. Type	Required VGA monitors (640 x 480 pixels)				
2. NavNet Interface	Ethernet 10-Base T				
3. Interface (NMEA 0183 format) --: any talker (menu selection)	Input: DBT, DPT, GGA, GLL, GSV, HDT, HDM, HDG, MTW, MWV, RMA, RMB, RMC, TTM, VHW, VTG, VYW, VWT, VWR, ZDA Output: AAM, APB, BOD, BWC, BWR, DBT, DPT, GGA, GLL, GTD, HDG, HDT, MHW, MSK, MTW, RMA, RMB, RMC, TLL, TTM, VHW, VTG, WPL, XTE, ZDA				
RADAR CHARACTERISTICS					
1. Display Modes	Head-up, Course-up*, North-up*, True Motion** (* Heading input required ** Heading and speed inputs required)				
2. Range Scales (nm)	0.125 to 24 nm 14 steps	0.125 to 36 nm 15 steps	0.125 to 48 nm 16 steps	0.125 to 64 nm 17 steps	0.125 to 72 nm 18 steps
3. Echo Trail	Interval: 15 s, 30 s, 1 min, 3 min, 6 min, 15 min, 30 min or Continuous				
PLOTTER CHARACTERISTICS					
1. Map Scale	0.125 to 2,048 nm				
2. Latitude Limits	Between 85°N and 85°S				
3. Plot Interval	1 s to 59 min 59 s or 0.01 to 9.99 nm				
4. Display Modes	Course plot, Nav data, Steering display, Highway				
5. Presentation Modes	TM/RM North-up, Course-up, Auto Course-up				
6. Memory Capacity	Up to 8,000 points for ship's track and marks 1,000 waypoints 200 planned routes (max. 35 waypoints/route)				
7. Alarms	Arrival/anchor watch, XTE, proximity alert, ship speed, depth*, water temperature*, fish* (*Network Sounder required, temperature sensor required for water temperature alarm)				
8. Electronic Charts*	Loaded from a FURUNO MiniChart, Navionics® Nav-Chart, C-MapNT chart cards *Chart must be determined when ordering. Choice of two units: Furuno & Navionics® or C-Map				
ANTENNA RADIATOR					
1. Type	Ø460 mm (18") Radome	Ø602 mm (24") Radome	1035 mm (3.5 ft) Open	1255 mm (4 ft) Open	1795 mm (4/6 ft) Open
2. Rotation Speed	30 rpm(0.125 to 2 nm), 24 rpm(3 to 24 nm)	24 rpm	24/48 rpm	24/48 rpm	24/48* rpm *not available in 6 ft
3. Wind Load	Relative 100 kt	Relative 100 kt	Relative wind 100 kt (24 rpm) Relative wind 70 kt (48 rpm)		
4. Beamwidth	Hor: 5.2° Vert: 25°	Hor: 3.9° Vert: 20°	Hor: 2.2° Vert: 22°	Hor: 1.9° Vert: 22°	Hor: 1.9/1.2° Vert: 22°
RF TRANSCIVER					
1. Peak Output Power	2.2 kW	4 kW	4 kW	6 kW	12 kW
2. Frequency	9410 ± 30 MHz (X-Band)				
3. Pulselength & PRR	0.08 µs/2100 Hz (0.125 to 1.5 nm) 0.3 µs/1200 Hz (1.5 to 3 nm) 0.8 µs/600 Hz (3 to 64 nm)				0.08 µs/2100 Hz (0.125 to 1.5 nm) 0.3 µs/1200 Hz (1.5 to 3 nm) 0.8 µs/500 Hz (3 to 72 nm)
ENVIRONMENT (IEC 60945 test method)					
Temperature	-15°C to +55°C (Processor Unit, Control Unit) -25°C to +70°C (Antenna Unit)				
Waterproofing	IEC 60529 IPX2, USCG CFR-46 (Processor Unit) IEC 60529 IPX5, USCG CFR-46 (Control Unit) IEC 60529 IPX6 (Antenna Unit)				
POWER SUPPLY					
	12-24 VDC Max. 46 W	12-24 VDC Max. 58 W	12-24 VDC Max. 66/77 W	12-24 VDC Max. 72/86 W	12-24 VDC Max. 86/98 W
	115/230 VAC with optional rectifier PR-62/RU-3423				
Power Amp Unit	Not Available				PSU-005
Optional unit					
Antenna Bracket	OP03-92		Not Available		
10-Target Autoplotter	ARP-11* (* Requires appropriate heading sensor)				
External Buzzer	OP03-136 or Relay/Contact Closure				
NTSC/PAL Interface kit	Supplied as standard				

Control Unit (Bracket Mount)

0.9 kg 2.0 lb

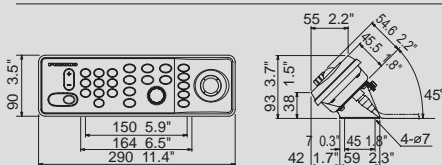

Control Unit (Flush Mount)

0.8 kg 1.8 lb

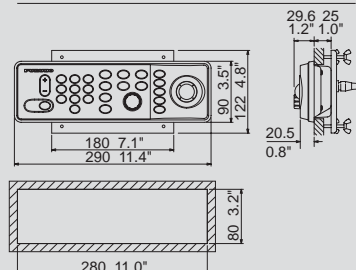



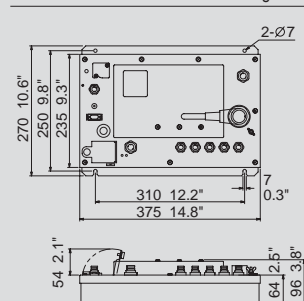

Processor Unit

4.0 kg 8.8 lb



SPECIFICATIONS OF NavNet SERIES

	VideoPlotter		
	GP-1710C	GP-1900C	GP-1900C-BB
			
DISPLAY UNIT			
1. Type	7" Color VGA LCD, 480 x 640 pixels	10.4" Color TFT LCD, 640 x 480 pixels	Required VGA monitor (640 x 480 pixels)
2. NavNet Interface	Ethernet 10-BaseT		
3. Interface (NMEA 0183 format) --: any talker (menu selection)	Input: DBK, DBS, DBT, DPT, GGA, GLL, GSV, HDT, HDM, HDG, MSS, MTW, MWV, RMA, RMB, RMC, TTM, VHW, VTG, VYW, VWT, VWR, ZDA Output: AAM, APB, BOD, BWC, BWR, DBT, DPT, GGA, GLL, GTD, MSK, MTW, RMA, RMB, RMC, TLL, VHW, VTG, WPL, XTE, ZDA		
PLOTTER CHARACTERISTICS			
1. Map Scale	0.125 to 1,024 nm	0.125 to 2,048 nm	
2. Latitude Limits	Between 85 N and 85 S		
3. Plot Interval	1 s to 59 min 59 s or 0.01 to 9.99 nm		
4. Display Modes	Course plot, Nav data, Steering display, Highway		
5. Presentation Modes	TM/RM North-up, Course-up, Auto Course-up		
6. Memory Capacity	Up to 8,000 points for ship's track and marks 1,000 waypoints 200 planned routes (max. 35 waypoints/route)		
7. Alarms	Arrival/anchor watch, XTE, proximity alert, ship speed, depth*, water temperature*, fish* (*Network Sounder required, temperature sensor required for water temperature alarm)		
8. Electronic Charts*	Loaded from a FURUNO MiniChart, Navionics® Nav-Chart, C-MapNT chart cards * Chart must be determined upon ordering. Choice of two units: Furuno & Navionics® or C-Map		
ENVIRONMENT (IEC 60945 test method)			
Temperature	-15°C to +55°C		-15°C to +55°C (Processor Unit, Control Unit)
Waterproofing	IEC 60529 IPX5, USCG CFR-46		IEC 60529 IPX2, USCG CFR-46 (Processor Unit) IEC 60529 IPX5, USCG CFR-46 (Control Unit)
POWER SUPPLY			
	12-24 VDC Max. 18 W	12-24 VDC Max. 40 W	12-24 VDC Max. 19 W
	115/230 VAC with optional rectifier PR-62/RU-3423		
Optional unit			
Autoplotter	Full control when networked with 10.4" LCD, BB system or 10" CRT and ARP-11		
External Buzzer	OP03-136 or Relay/Contact Closure		
NTSC/PAL Interface kit	Not Available		Supplied as standard

	MULTI-PURPOSE MARINE LCD DISPLAY	
	MU-120C	MU-155C
		
DISPLAY CHARACTERISTICS		
Screen Size	12.1 inches, 246.0 x 184.5 mm	15 inches, 304.1 x 228.1 mm
Resolution	800 x 600 (SVGA)*	1024 x 768 (XGA)*
	* VGA up to SXGA signal is acceptable in analog RGB.	
Contrast Ratio	300: 1	400:1
Viewing Angle		
Vertical	+60° to -50°	+85° to -85°
Horizontal	left 70° to right 70°	left 85° to right 85°
Brightness	1000 cd/m2	
INTERFACE		
Analog RGB	2 ports, D-SUB/15 pins	
DVI	1 port, DVI-D	
RCA	3 ports, RCA	
ENVIRONMENT (IEC 60945 test method)		
Temperature	-15°C to +55°C	
Waterproofing	IEC 60529 IPX5 (Front Panel)	
POWER SUPPLY		
	12-24 VDC, 4-2 A	12-24 VDC, 7-3 A

MU-120C

6.5 kg 14.3 lb

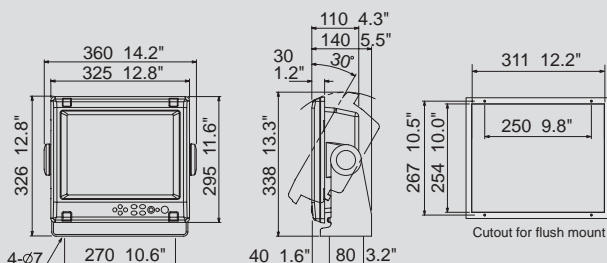

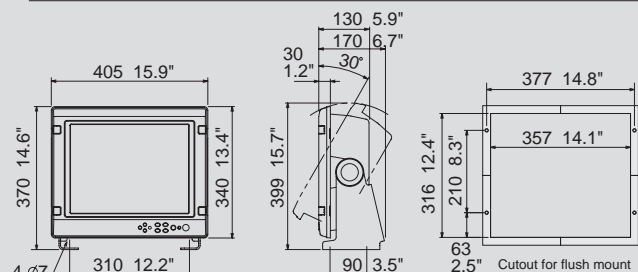

MU-155C

8.5 kg 18.7 lb

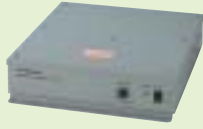

		Network Sounder	
		ETR-6/10N	ETR-30N
			
TRANSCIVER & DISPLAY			
Display Modes	Single (50 or 200 kHz), Dual (50 and 200 kHz), Bottom-lock, Bottom Zoom, Bottom Discrimination, Marker Zoom, A-Scope	Single (Hi or Low frequency), Dual (both Hi and Low frequency) Bottom-lock, Bottom Zoom, Bottom Discrimination, Marker Zoom, A-Scope	
Frequency	Dual frequency 50 kHz and 200 kHz	The synthesized transducer works with dual frequencies in 28 to 200 kHz	
Output Power	600 W / 1 kW rms (Specify)	1, 2 or 3 kW (Specify)	
Range Scale	Any ranges customized between 2 and 1200 m (4,000 ft, 650 fa)	Any ranges customized between 2 and 1500 m	
Range Phasing	Up to 2,400 m (8,000 ft, 1,300 fa)	Up to 3000 m	
ENVIRONMENT (IEC 60945 test method)			
Temperature	-15°C to +55°C	-15°C to +55°C	
Waterproofing	IEC 60529 IPX2	IEC 60529 IPX0	
POWER SUPPLY			
	12-24 VDC Max. 11.0 W	12-24 VDC Max. 30 W	
TRANSDUCERS (Specify when ordering)			
	50/200 kHz transducers 520-5PSD (Plastic thru-hull), 520-5MSD (Bronze thru-hull), 520-5PWD (Plastic transom), 525ST-MSD (Bronze thru-hull w/speed/temp sensor), 525ST-PWD (Plastic transom w/speed/temp sensor) Single frequency transducers (Optional Matching box MB-1000 required) 50 kHz: 50B-6, 50B-6G, 50B-6B, 50B-62M, 50B-9B, 50B-92M 200 kHz: 200B-5, 200B-5S, 50/200-1T, 50/200-12M	28 kHz transducers: 28F-8, 28F-18, 50BL-24H, 28F-24H 50 kHz transducers: 50B-6/6B, 50B-9/9B, 50F-8G, 50B-12, 50BL-12 88 kHz transducers: 88B-8, 88B-10, 88F-126H 107 kHz transducer: 100B-10R 200 kHz transducers: 200B-5S, 200B-8/8B, 200B-8N, 200B-12H	

		WAAS/GPS Receiver Antenna	
		GP-320B	
			
RECEIVER CHARACTERISTICS			
Receiver Type	Twelve discrete channels, C/A code, all-in-view, WAAS		
Receiver Frequency	L1 (1575.42 MHz)		
Time to First Fix	12 s (warm start)		
Tracking Velocity	999 kt		
Geodetic Systems	WGS-84, NAD-27 and others		
Accuracy	10 m (GPS) 3 m (WAAS)		
ENVIRONMENT (IEC 60945 test method)			
Temperature	-25°C to +70°C		
Waterproofing	IEC 60529 IPX6		
POWER SUPPLY			
	12-24 VDC		

		Network Weather Facsimile Receiver	
		FAX-30	
			
TRANSCIVER CHARACTERISTICS			
Frequency Range	80 kHz to 160 kHz, 2 MHz to 25 MHz, 490 kHz, 518 kHz (NAVTEX)		
Class of Emission	F3C, J3C, F1B (NAVTEX)		
Receiving System	Double superheterodyne		
Storage	Fax: 12 pictures, NAVTEX: 130 messages		
ENVIRONMENT (IEC 60945 test method)			
Temperature	-15°C to +55°C		
Waterproofing	IEC 60529 IPX2		
POWER SUPPLY			
	12-24 VDC, 12 W		

SPECIFICATIONS OF NavNet SERIES

18" Radome Antenna

4.9 kg 10.8 lb

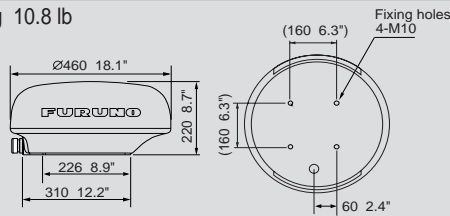

24" Radome Antenna

8 kg 17.6 lb

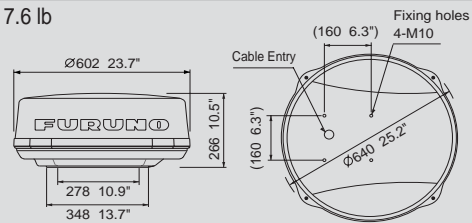

2 ft Open Antenna

14 kg 30.9 lb

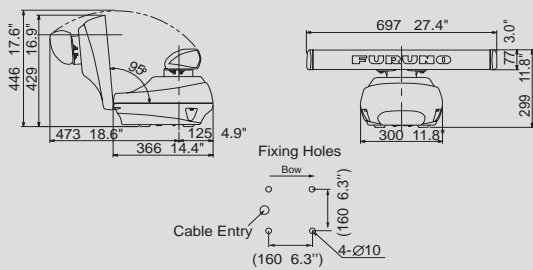

3.5 ft Open Antenna

22 kg 48.5 lb

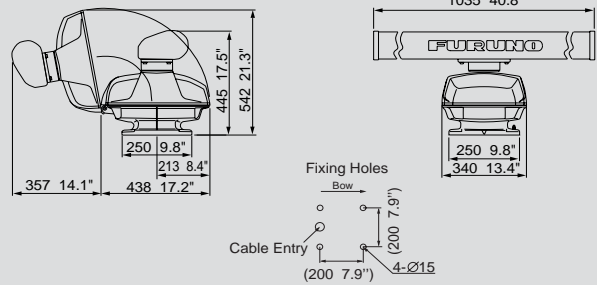

4 ft Open Antenna

23 kg 50.7 lb

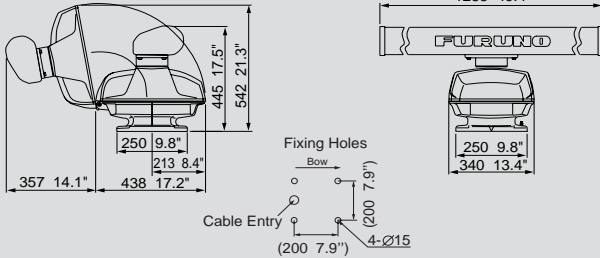

6 ft Open Antenna

25 kg 55.1 lb

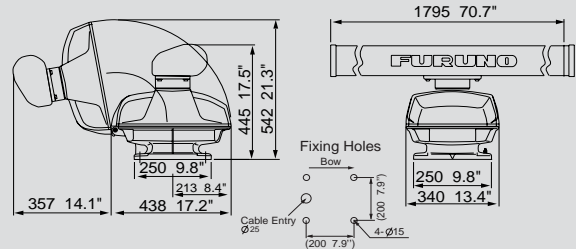

Network Sounder ETR-6/10N

1.5 kg 3.3 lb

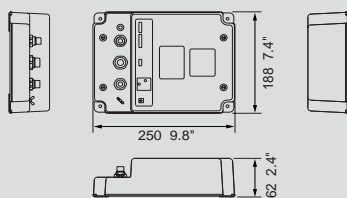

Network Sounder ETR-30N

5.6 kg 12.4 lb

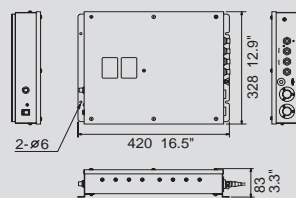

WAAS/GPS Antenna GP-320B

0.8 kg 1.8 lb
10 m cable attached

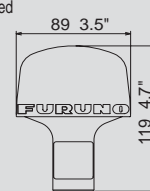

Network Weather Facsimile Receiver FAX-30

1.5 kg 3.3 lb

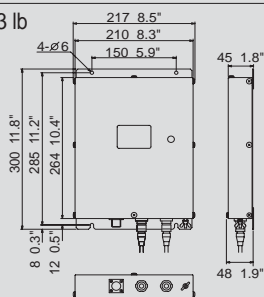

Remote Controller

0.06 kg 0.1 lb

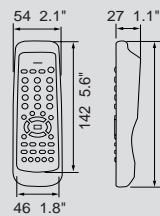

Power Amp Unit for MODEL 1953C/1953C-BB

1.9 kg 4.2 lb

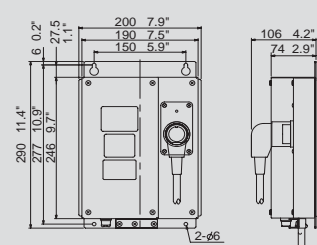

Ethernet is a trade mark of Xerox corporation, registered in U.S. and other countries.
Navionics® is a trade mark of Navionics®, registered in U.S. and other countries. Smart Sensor™ is a trade mark of AIRMAR, registered in U.S. and other countries.

SPECIFICATIONS SUBJECT TO CHANGE WITHOUT NOTICE

FURUNO U.S.A., INC.

Camas, Washington, U.S.A.
Phone: +1 360-834-9300 Telefax: +1 360-834-9400

FURUNO (UK) LIMITED

Denmead, Hampshire, U.K.
Phone: +44 2392-230303 Telefax: +44 2392-230101

FURUNO FRANCE S.A.

Bordeaux-Mérignac, France
Phone: +33 5 56 13 48 00 Telefax: +33 5 56 13 48 01

FURUNO ESPAÑA S.A.

Madrid, Spain
Phone: +34 91-725-90-88 Telefax: +34 91-725-98-97

FURUNO DANMARK AS

Hvidovre, Denmark
Phone: +45 36 77 45 00 Telefax: +45 36 77 45 01

FURUNO NORGE A/S

Ålesund, Norway
Phone: +47 70 102950 Telefax: +47 70 127021

FURUNO SVERIGE AB

Västra Frölunda, Sweden
Phone: +46 31-7098940 Telefax: +46 31-497093

FURUNO FINLAND OY

Espoo, Finland
Phone: +358 9 4355 670 Telefax: +358 9 4355 6710

04045KS Printed in Japan