



TOP-SNAPPER®

Snap or unsnap your boat canvas with the Top-Snapper tool!

The Top-Snapper's notched blade fits over the snap to enable it to be aligned and snapped. The Top-Snapper is the only snap tool that will work on either inside or outside snaps. Comfortable, ergonomic grip and stainless steel blades are designed for tough marine conditions.

Part # 008.1



CANVAS CARE KIT

All the essential parts for canvas repair in one floating case!

Specifically designed for onboard repairs, the Canvas Care Kit contains replacement snaps, a snap installation tool, and Snap Lube to keep snaps working smoothly. The ideal companion to the Top-Snapper tool.

Part # 008.3



SNAP SETTER™

Why go to a custom repair shop to fix your canvas snaps when you can do it yourself with the Snap Setter tool?

With snap-shaped dies welded directly to a rugged locking plier, the Snap Setter Tool is designed to install the cap (dome) of the snap directly to the canvas. The locking plier design provides greater leverage than die-and-peg snap tools, and makes canvas snap installation quick and easy.

Part # 008.4



DECK MATE™

Want instant access to six of your most commonly used boating tools?

You want the DeckMate Boat Tool! On one end, the DeckMate includes two universal deck plate keys, a boat shackle key, a flat-head screwdriver, and a 1/4" Hex head driver. On the other end, you'll find a zipper/toggle pull and a bottle opener. No other boat tool offers a deck plate key, boat shackle key and four other handy tools in one package.

Part # 007.0

EASY TROLLER™ trolling plate

Innovative flex design prevents damage to your trolling plate!

The EasyTroller's patented design allows the plate to flex upward under accidental acceleration. Now you can troll at the ideal speed without worrying about damaging your plate.

The EasyTroller mounts directly to the engine's cavitation plate. It snaps down into position a few inches behind the prop to slow you down to the ideal trolling speed. It releases with the same simple pull of the cord.

The EasyTroller is manufactured in the USA from marine grade aluminum with stainless steel hardware. It is available in two models, with or without hydrofoil fins.

EasyTroller Features

- Patented hinge design prevents damage to the trolling plate under accidental acceleration
- Fits outboard and I/O motors 50 hp and up
- Offered with or without hydrofoil fins
- Heavy duty anodized aluminum construction

The EasyTroller Advantage



Under power, prop thrust can bend or damage the typical trolling plate.



The EasyTroller plate flexes to divert the prop thrust downward, preventing damage to the plate itself.



Choose from two models

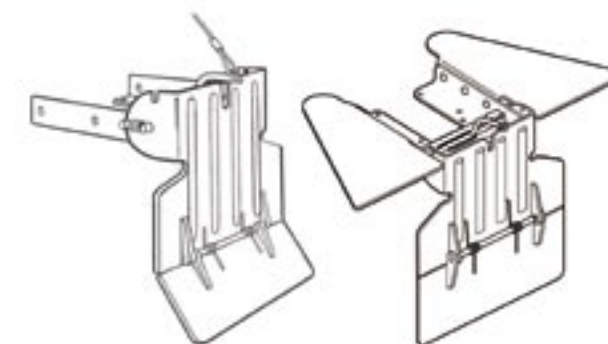

016.1 – Standard Model 016.2 – Fins Model
(016.3 – Fins Only)

HELMSMATE™ motor extension handles

Want to sit forward in the boat while maintaining steering and throttle control of your gas or electric trolling motor?

The HelmsMate Motor Extension Handle simply clamps to the motor's tiller handle to enable you to control speed and direction without having to sit next to the motor.

The HelmsMate U-Model offers a unique all metal universal joint that enables the handle to fit up over a transom and to provide offset steering. And the HelmsMate's lifetime warranty means free replacement or repair for the life of the handle if anything goes wrong.

HelmsMate Features

- Clamps directly to the tiller handle for steering and throttle control
- Fits all tiller handles on motors up to 15 hp
- Clear access to the kill button
- Marine grade construction in the USA
- Lifetime warranty

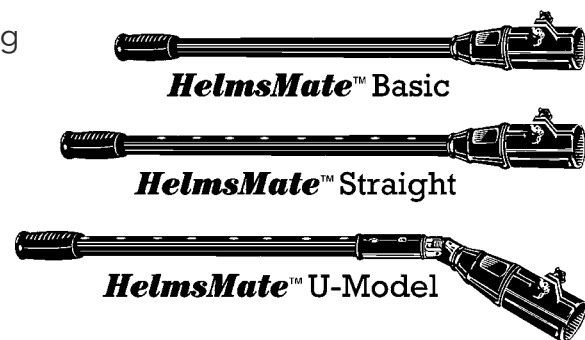

| Model | Key Features | Length | Application |
|-------------------|--------------------------------------------------------------------------------------------------------------------|---------------------------|-------------------------------------------------------------|
| HelmsMate U 001.0 | All metal universal joint enables easy push/pull steering. Lockout sleeve will convert handle to a straight handle | Extendable from 37" – 51" | Gas outboards and electric trolling motors |
| HelmsMate S 001.1 | Straight handle for direct steer feel | Extendable from 36" – 50" | Gas outboards and electric trolling motors |
| HelmsMate B 001.2 | Ideal for trolling motors and applications where only a short extension is needed | 30" fixed length | Electric trolling motors and some gas outboard applications |



ANCHORLIFT™ anchor retrieving system

The AnchorLift anchor retrieving system was designed with one thought in mind: to make lifting your boat anchor easier. The AnchorLift simply slides on your anchor line and floats the anchor to the surface. For the active boater or fisherman, the AnchorLift makes all the difference between a good and bad day on the water.

How does the AnchorLift Work?

1. Slide the AnchorLift over your anchor line, anchor as normal, and drop the AnchorLift into the water.
2. When you are ready to raise your anchor, simply motor forward around your anchor line to break your anchor free,
3. Pull your anchor to the surface. The AnchorLift sliding bolt will lock the anchor for easy retrieval once it has reached the surface.

Anchor Lift Features

- Tough nylon body reinforced with stainless steel at all wear points. Backed by a lifetime warranty!
- Raises anchors up to 80 pounds using 3/8" to 5/8" anchor line
- Stainless steel sliding bolt locks anchor at the surface
- Acts as a marker buoy when quick anchor release is necessary
- Can be used with crab and shrimp pots too

| Part # | Description | Buoy Diameter | Lifting Capacity |
|--------|--------------------------|---------------|------------------|
| 002.0 | AnchorLift | Not Included | NA |
| 002.1 | AnchorLift w/ Stand Buoy | 11.5 in | 30 lbs |
| 002.2 | AnchorLift w/ Large Buoy | 15.5 in | 60 lbs |
| 002.3 | AnchorLift w/ Jumbo Buoy | 18.5 in | 80 lbs |

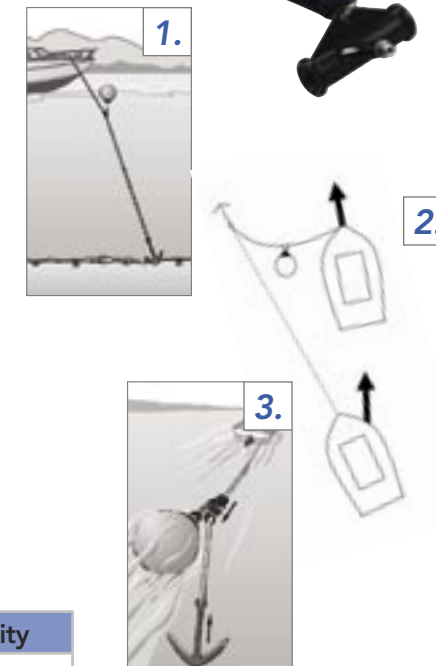

ANCHOR RING anchor retrieving system

Floats anchors like the AnchorLift but designed specifically for saltwater applications where 10 or more feet of anchor chain are commonly used. Clips onto the line when ready to use.

To use the Anchor Ring simply slip the ring over your anchor line, throw the ring and buoy into the water and motor forward around your anchor. The buoy will drag behind the boat and float the anchor to the surface. The anchor chain will slide through the ring and counterbalance the anchor at the surface.

Anchor Ring Features

- Stainless steel ring and shackle
- Will lift anchors up to 80 pounds
- Offered in standard and heavy duty versions with and without buoys

| Description | Std Part # | HD Part # | Buoy Diameter | Lifting Capacity |
|------------------------------|------------|-----------|---------------|------------------|
| Anchor Ring | 002.3 | 002.35 | None | NA |
| Anchor Ring Assembly | 002.4 | 002.45 | None | NA |
| Anchor Ring w/ Standard Buoy | 002.5 | 002.55 | 11.5 in | 30 lbs |
| Anchor Ring w/ Large Buoy | 002.6 | 002.65 | 15.5 in | 60 lbs |
| Anchor Ring w/ Jumbo Buoy | 002.7 | 002.75 | 18.5 in | 80 lbs |

Standard is .25" Stainless Wire, HD is .3125" Stainless Wire





Y600 Yacht Ramp

BOARDING RAMPS

Board your boat in style!

These refined yet rugged boarding ramps are the perfect alternative to aluminum or wood boarding ramps: lightweight, remarkably strong, and easy to use and store.

Ideal for your yacht or pontoon boat, our boarding



P600 Pontoon Ramp

ramps feature a honeycomb composite core for the ideal combination of strength, weight and value.

Features

- Lightweight and portable, weighing only 35 pounds
- 72" long x 21" wide with a load capacity of 600 pounds
- Incorporates cutting edge honeycomb technology for superior strength/weight characteristics
- Permanent non-skid surface prevents slipping even in wet conditions
- Made entirely from marine-grade materials

Part # 010.0 Y600 Yacht Ramp with Stainless Mounting Brackets

Part # 010.2 P600 Pontoon Ramp with Powder-coated Rails

Comes complete with stainless steel brackets for yachts or powder-coated rails for pontoon boats.

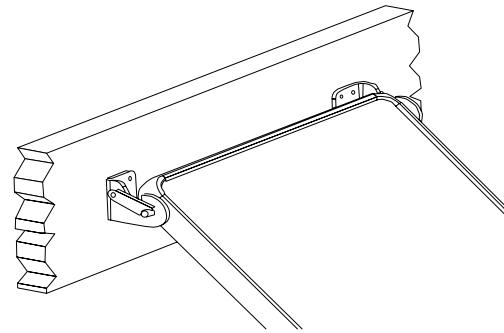

Y600 Mounting Brackets



006.1 HD Model

LAND ANCHORS

Moor your boat securely to shore with the Land Anchor.

Welded helix design is the same design used to anchor marinas in place. Why? Because it offers far better holding power than straight mooring stakes of just about any length.

The Land Anchors simply screw into the ground and provide a place to tie your mooring line. Offered in two models, the Heavy Duty model

comes equipped with a carrying bag and separate turning bar. Both models measure 22" long with a 4" helix and a powdercoat finish.

Part # 006.0 Heavy Duty Model and 006.1 Basic Model

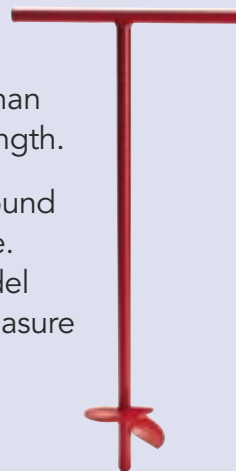

Basic Model

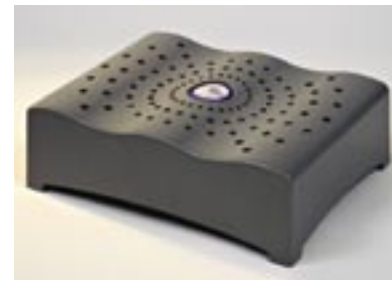

DRYWAVE™ AIR DRYERS

Ideal for boats, RVs, cabins and even homes, DryWave air dryers gently warm and dry the air to prevent moisture buildup in enclosed areas. The DryWaves efficiently raise the interior dew point, inhibiting the surface condensation that often leads to mold and mildew.

Designed to run safely and continuously for extended periods, DryWave air dryers include no moving parts and plug directly into a standard 120 volt outlet. The original DryWave is designed for rooms and spaces up to 1,000 cubic feet, while the DryWave 100 is designed for use in lockers and gun safes up to 100 cubic feet. The Drywave is effective in cooler damp climates and is not designed to dehumidify in warm climates.



DryWave 100

Features:

- The DryWave air dryers gently warm the air to prevent condensation and mold buildup
- Ideal for use in spaces up to 1,000 cubic feet
- Ideal for boats, RV's, and cabins
- DryWave draws current of only 120 watts, DryWave 100 only 20 watts
- Safe - No moving parts and equipped with a thermal cut-off switch* to prevent overheating
- UL-Listed* - Designed and tested for safe, continuous operation
- Two year warranty and made in the USA

| Part # | Description | Capacity | Wattage | Dimensions |
|--------|-------------|-----------------|---------|--------------------|
| 015.1 | DryWave | 1000 Cubic Feet | 120 w | 13.5" x 10.5" x 4" |
| 015.2 | DryWave 100 | 100 Cubic Feet | 20 w | 8.5" x 2" |

*DryWave only



STREAKSTOPPERS™

Finally, the first preventative solution to the black streaking caused by deck water runoff.

The StreakStoppers mount just under the rub-rail to direct runoff away from the hull, preventing the black streaking commonly found on boat hulls. They eliminate the need for chemical cleaners and hull scrubbing.

Easy to mount under the rub rail at each drain point, the StreakStoppers are virtually invisible once installed. Available in packs of four and six.



StreakStopper Features

- Prevent black streaks on your hull sides
- Reduce hull maintenance and cleaning
- Environmentally friendly. Eliminates the need for chemical cleaners that usually end up in the water
- Virtually invisible once installed
- UV Poly Blend with 3M adhesive

Part # 004.1 - 4 pack and 004.2 - 6 pack

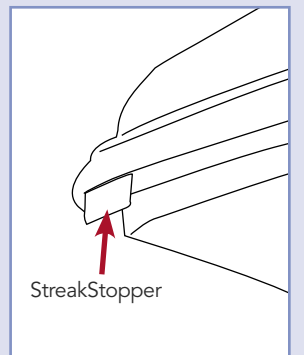

StreakStopper



STICKYBOARDS™

If you've ever cut your bait or filleted your fish out on the water, you know that boat movement is a fact of life. We've mounted suction cups to our StickyBoards to anchor the boards when you are handling the knife.

Offered in two popular sizes, the StickyBoards are fabricated from food-grade polyethylene to ensure long life and to protect the sharpness of the knife. The suction cups are removable so that the board can be used on either side.

StickyBoards are available in two different sizes:

Part # 003.2 - Small (6" x 10"), 2 suction cups

Part # 003.4 - Large (9" x 15"), 4 suction cups

E-Z SLIDE AND BUNKENDER TRAILER PADS

Looking for an easier way to launch and load your boat from your bunk trailer?

Look no further: E-Z Slide trailer pads mount easily to your trailer bunks to enable your boat to slide smoothly on and off the trailer. The BunkEnders mount directly to the high-wear area at the end of your trailer bunks, protecting the carpet while you launch and load your boat.

E-Z Slide and BunkEnd Features

- Molded from a slippery plastic composite
- Available in multiple widths in either black or white.
 - E-Z Slides are 10" long, BunkEnders 8" long.
- Stainless steel mounting screws included



"Ideal for pontoon boat trailers!"

Recommended for metal boats weighing up to 4000 pounds and fiberglass boats weighing up to 1500 pounds.

Not recommended for boats with painted bottoms or fiberglass boats weighing more than 1500 pounds.

Five-year warranty

| Model | Model # | Pad Width | Includes | Bunk Width | Application |
|------------|---------|-----------|----------------------|------------|-----------------------|
| Kit 1 | 013.0 | 1.5" | 8 Pads | 2" | Fits two 8' Bunks |
| Kit 2 | 013.1 | 3" | 4 Pads, 2 BunkEnders | 4" | Fits two 5 1/2' Bunks |
| Kit 3 | 013.2 | 3" | 8 Pads, 2 BunkEnders | 4" | Fits two 10' Bunks |
| Kit 4 | 013.3 | 5.25" | 10 Pads | 6" | Fits two 10' Bunks |
| BunkEnders | 013.6 | 3" | 2 BunkEnders | 4"-6" | For two Bunks |