



# ZR UNIVERSAL MOUNTING PLATE INSTRUCTIONS



## TOOLS

- #3 Phillips Head Screwdriver
- 7/16" Socket
- 7/16" Wrench
- Ratchet
- Electric Drill
- 5-16" Drill Bit

## INCLUDED HARDWARE

QTY.	LABEL	ITEM #	DESCRIPTION
6	A	AVG-MH-BT-0310	1/4" x 20 x 2 1/2" Flat Head Phillips Drive Screw, Stainless
1	B	AVG-MP-0641	Universal Mounting plate - Scissor
6	C	AVG-MP-0915	1/4" Rubber Washer
6	D	AVG-MH-WS-0306	1/4" Large Flat Washer, Stainless
6	E	nut-14-tall	1/4" Tall Nylon Lock Nut
6	F	AVG-MH-BT-0322	1/4" x 20 x 5/8" Hex Head Bolt, Stainless
6	G	AVG-MH-BT-0321	1/4" Lock Washer, Stainless
6	H	wash-14-pp	1/4" Small Flat Washer, Stainless

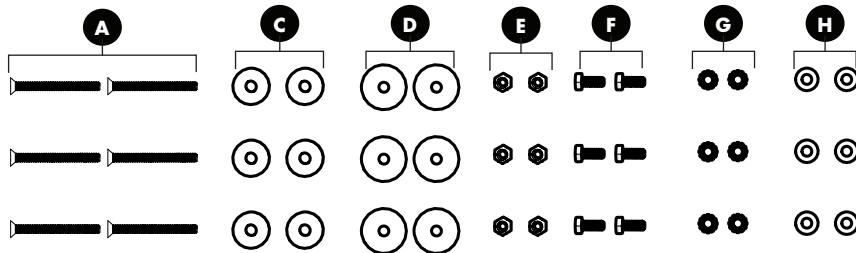
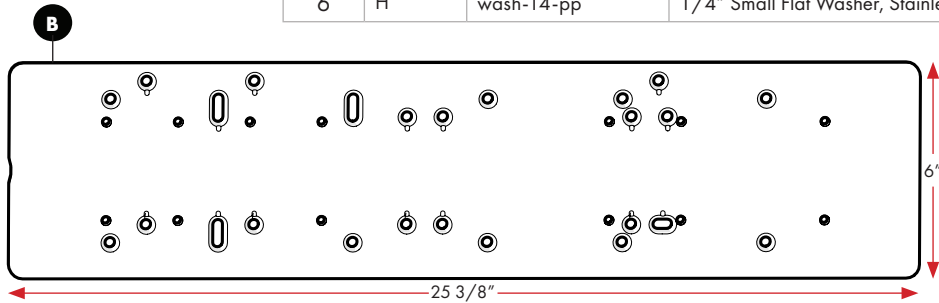

## MOUNTING PARAMETERS

Use the following parameters to locate a suitable mounting location:

- When deployed, the shaft should be as close to the center-line of boat deck as possible.
- Ensure there are no obstructions or sensitive components on or under the boat deck where the mounting hardware will be installed.
- When deployed, ensure the shaft is more than 1" off the gunwale/rub rail of the boat.
- Ensure there are no obstructions blocking the motor from fully deploying and stowing.
- If mounting to a curved boat deck, ensure **Rubber Washers C** are used between the motor and deck.

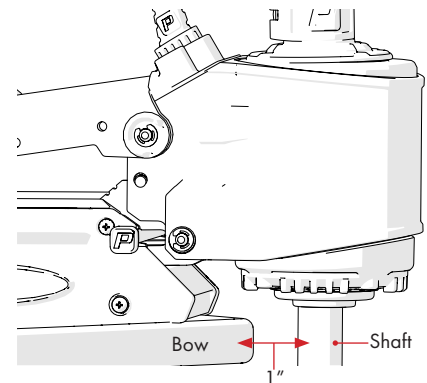

Shaft Clearance

Need help? Contact our Customer Service Team at 1 + 813.689.9932 Option 2



# ZR UNIVERSAL MOUNTING PLATE INSTRUCTIONS



## INSTALLING UMP TO BOAT WITH PREVIOUSLY DRILLED HOLES

Install the UMP Mounting Hardware in order. While holding **Screws A** with a **#3 Phillips Head Screwdriver**, tighten hardware snug using a **7/16" Socket & Wrench**.

1. (6) **Screws A**
2. **UMP B**
3. (6) **Rubber Washers** (if needed) **C**
4. **Boat Deck**
5. (6) **Large Washers D**
6. (6) **Nylon Lock Nuts E**

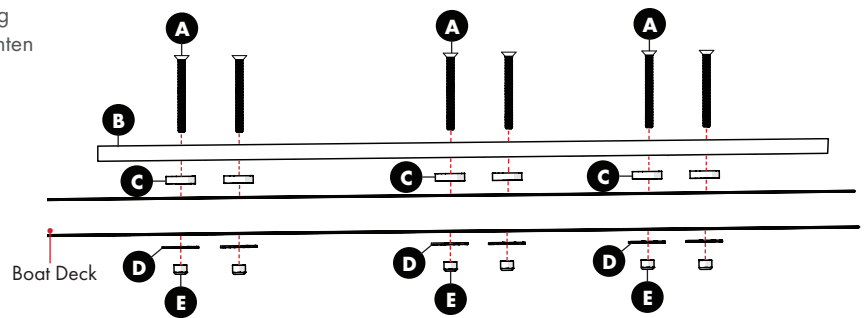

Universal Mounting Plate to Boat Deck

**IMPORTANT!** When deployed, ensure the shaft is no less than 1" off the gunwale/rub rail of the boat.

**ALSO:** Make sure the cut-out is facing the front of the boat and the counter-sunk holes are facing upright.

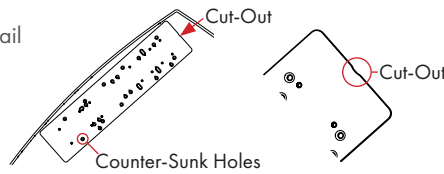

## INSTALLING UMP TO BOAT WITH NO PREVIOUSLY DRILLED HOLES

**STEP 1** Lay UMP on the boat deck, then lay the ZR Mounting Template on the UMP, lining up mounting holes on the UMP with those on the Template to check clearances.

**STEP 2** After re-checking clearances and reading the **Mounting Parameters** on p. 1 of these instructions, mark and drill Pilot holes for the **Flat Head Screws A** using a **5/16" Drill Bit**. Use the furthest possible forward two holes, the furthest possible back two holes, and two holes that are spaced evenly in between the others.

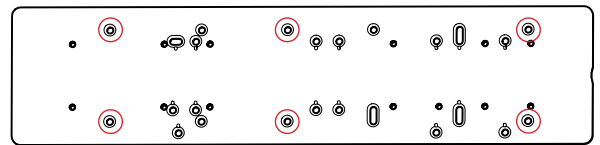

UMP Mounting Holes



Check the area beneath where the UMP will be mounted to ensure there are no hoses, wires lines tanks or other sensitive components

**IMPORTANT!** If installing to gel-coat, follow the drilling procedure in **Appendix A of the Installation & Owner's Guide** to ensure you do not crack or chip the gel-coat.

**ALSO:** Make sure the cut-out is facing the front of the boat and the counter-sunk holes are facing upright.

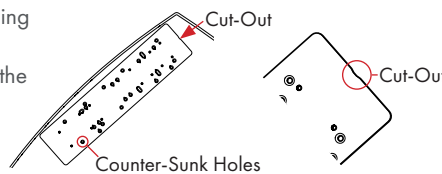

**STEP 3** Follow the above section (**Installing UMP to Boat with Previously Drilled Holes**) to for hardware order when installing the **UMP B** to the Boat Deck.



# ZR UNIVERSAL MOUNTING PLATE INSTRUCTIONS



Always disconnect power by turning the main battery cutoff switch to the off position before performing any installations.

## MOUNT ZR TO UMP

**STEP 1** Lay the trolling motor on top of the **UMP B** and line it up with the set of holes that allow for adequate clearance of the shaft and bow of the boat.

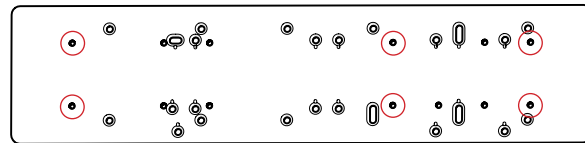

Preferred Mounting Example

**IMPORTANT!** At least 1" of clearance is required between the shaft and bow of the boat.

**STEP 2** Install the Move ZR Mounting Hardware in order. The hardware will screw into the **UMP B**. Using a **7/16" Socket and Ratchet**, tighten snug.

1. (6) Bolts **F**
2. (6) Lock Washers **G**
3. (6) Small Washers **H**
4. Trolling Motor
5. **UMP B**

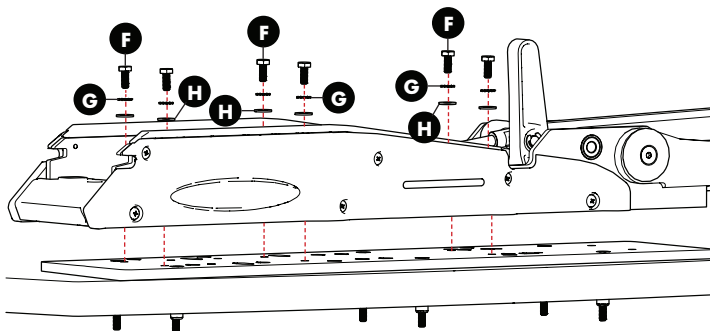

Mounting ZR to Universal Mounting Plate

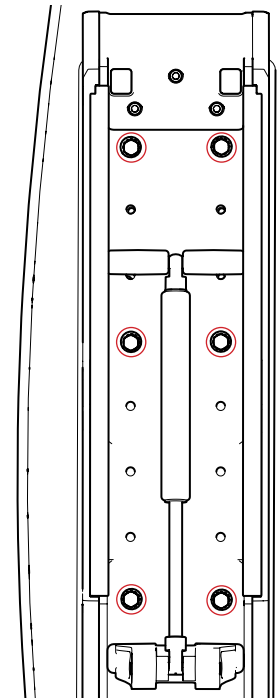

Preferred Mounting Example