

# **SEAVIEW**

**ELEVATE YOUR ELECTRONICS**

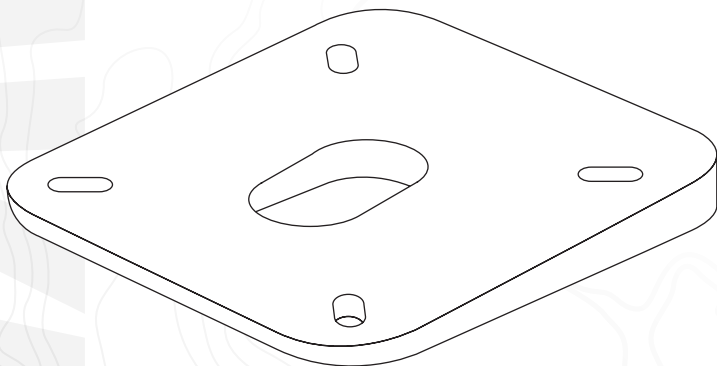

## **INSTALLATION INSTRUCTIONS**

For Seaview Direct Mount Wedges:

**RW4-1, RW4-2, RW4-3, RW4-4  
RW4-5, RW4-6, RW4-7**

Refer to website for most up to  
date instructions and videos.

**[WWW.SEAVIEWGLOBAL.COM](http://WWW.SEAVIEWGLOBAL.COM)**

# PARTS INCLUDED

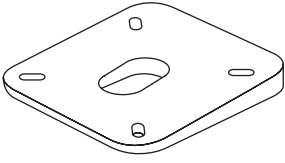

**RW4-1**

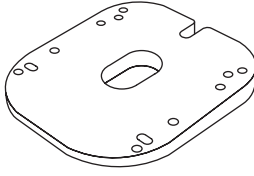

**RW4-2**

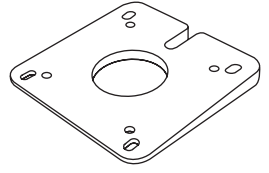

**RW4-3**

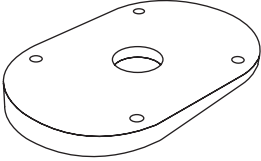

**RW4-4**

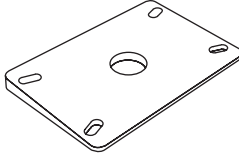

**RW4-5**

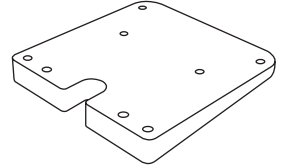

**RW4-6**

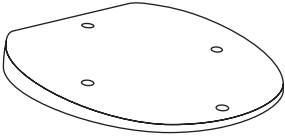

**RW4-7**

---

# TOOLS NEEDED

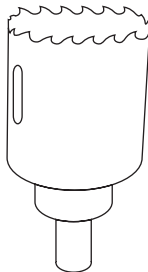
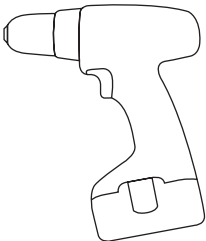
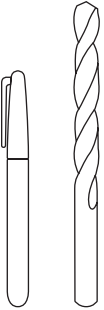

Sudbury Elastomeric Marine Sealant is recommended. To purchase call 800-655-7922 or visit [www.seaviewglobal.com](http://www.seaviewglobal.com)

**1** Place the wedge onto the mounting surface and mark all the holes.

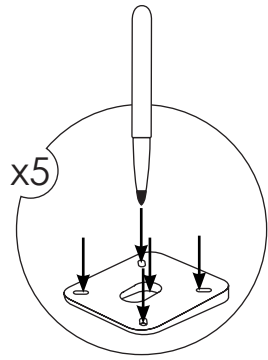

**2** Drill the four bolt holes.

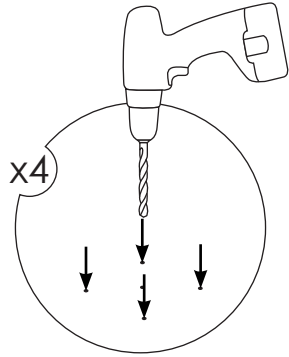

**3** Use a hole saw to drill a center hole to run cables through.

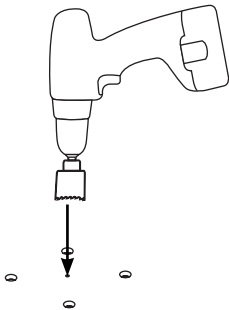

**4** Apply marine adhesive sealant to the bottom of the wedge. Then mount your radar to the wedge and secure into place.

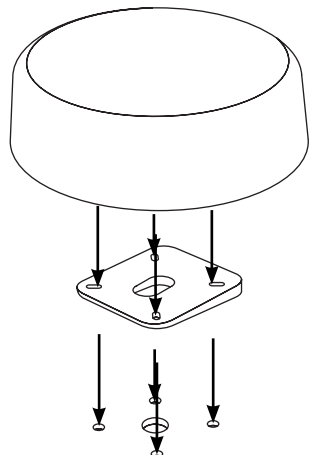

The background of the entire page is a light gray topographic map with white contour lines. The lines are irregular and wavy, representing elevation changes across a landscape. The map is centered and covers the entire area.

***SEAVIEW***///  
***ELEVATE YOUR ELECTRONICS***

***SEAVIEW***///

Tel: 800-655-7922  
[www.seaviewglobal.com](http://www.seaviewglobal.com)

***EUROPEAN OFFICE***

Tel: +33 4 94 53 27 70  
[www.seaviewprogress.com](http://www.seaviewprogress.com)

2-072618