

SEAVIEW

ELEVATE YOUR ELECTRONICS

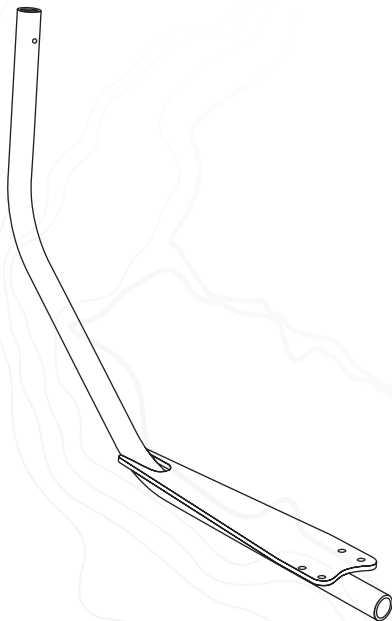

INSTALLATION INSTRUCTIONS

For Seaview Modular Light Bars:

LTB-0A, LTB-0A6

Refer to website for most up to
date instructions and videos.

WWW.SEAVIEWGLOBAL.COM

PARTS INCLUDED

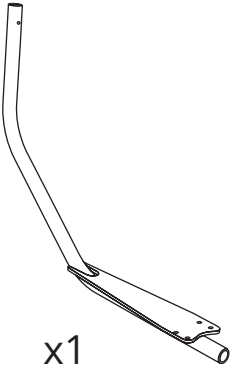

TOOLS NEEDED



Sudbury Elastomeric Marine Sealant is recommended. To purchase call 800-655-7922 or visit www.seaviewglobal.com

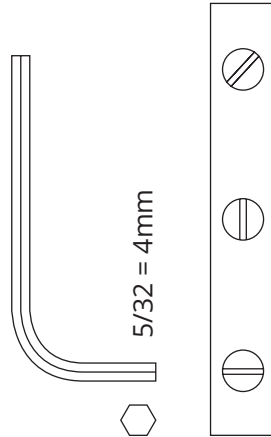

Route wiring through the Light Bar and then insert light into Light Bar. Procedure may vary depending on which light bar top you have. Refer to the Seaview Light Bar Top instructions.

1A

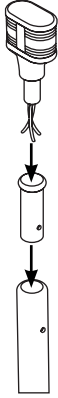

1B



1C

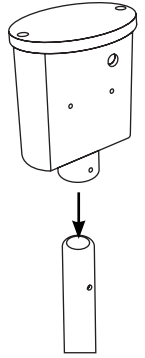

1D

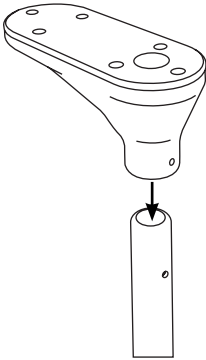

1E



2 Once your Light Bar Top is in place secure it with the two black rivets. Apply marine adhesive sealant around the holes of the rivets.

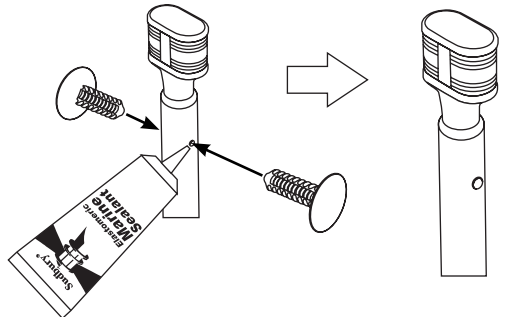

3

Insert the Light Bar into the back of the Seaview mount.

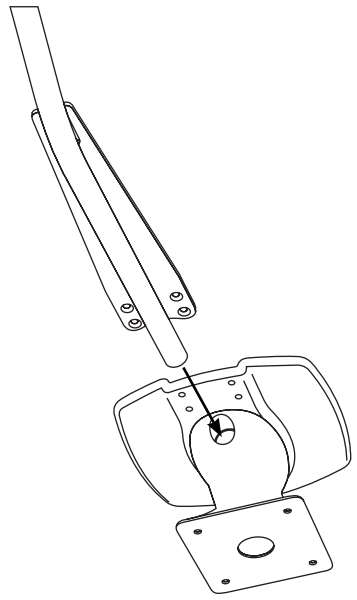

4

Secure the LTB-OA or LTB-OA6 to the Seaview Modular Top Plate by using the four 5/16"x1" bolts and washers.

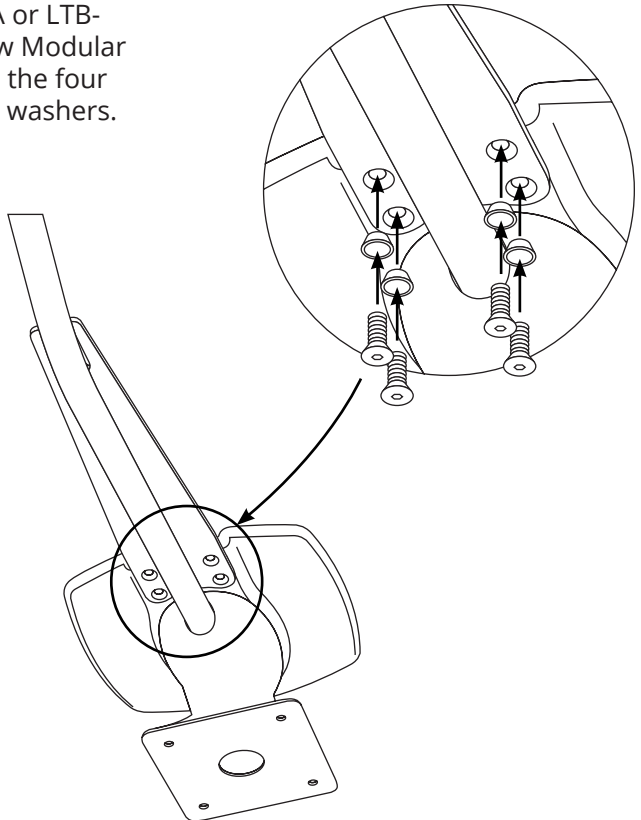

5

Make sure that the Light Bar is level.

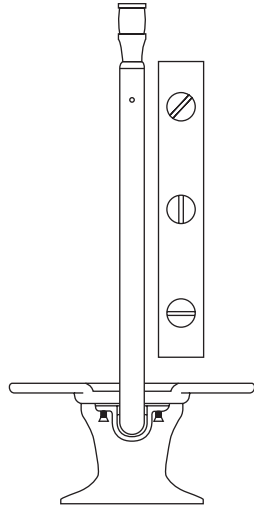

OPTIONAL ACCESSORIES

Call 800-655-7922 or visit www.seaviewglobal.com for available accessories.

LIGHT BAR TOPS

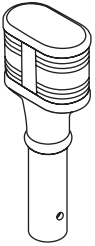

LTBP-1197
Perko 1197
incandescent
Light.

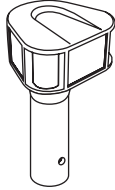

LTBA-7800
Attwood LED
Light.

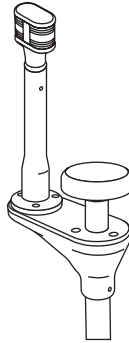

LTBU1A1197
Light Bar Top
with Perko 1197
Light, can fit GPS.

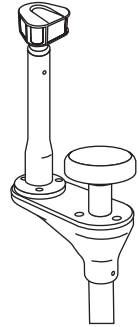

LTBU1A800
Light Bar Top
with Attwood
LED Light, can fit
GPS.

SPREADER KIT

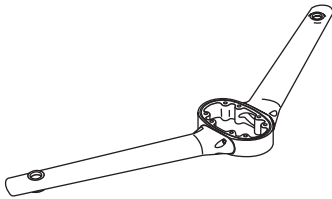

SP1-MOD
Allows user to mount GPS units or
antennas onto a Seaview Modular
Mount.

WEDGES

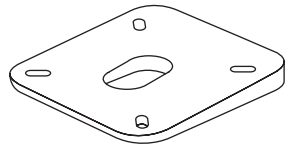

Compensates for plane angle.
Available in 2, 4 or 6 degree wedges.

HINGES

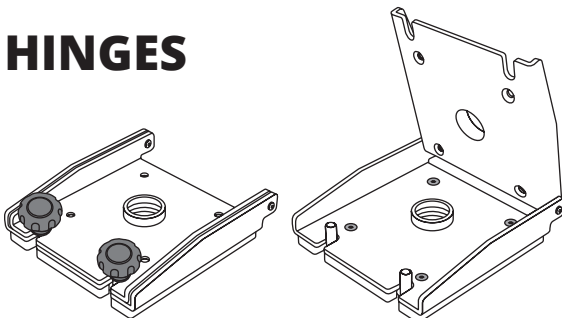

Seaview Hinge Adapters fold
in any direction necessary for
added height clearance.

CABLE GLANDS

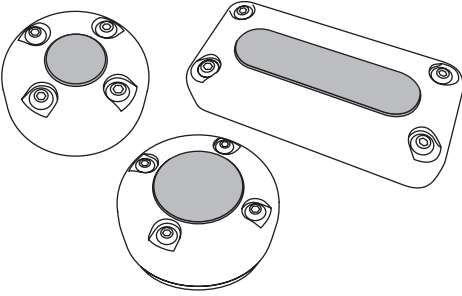

Seaview Cable Glands provide waterproof cable routing.

The background of the entire page is a light gray topographic map with white contour lines. The lines are irregular and wavy, representing elevation changes across a landscape. The map is centered and covers the entire area.

SEAVIEW//
ELEVATE YOUR ELECTRONICS

SEAVIEW//

Tel: 800-655-7922
www.seaviewglobal.com

EUROPEAN OFFICE

Tel: +33 4 94 53 27 70
www.seaviewprogress.com

1-082718