

1

This Quick installation guide provides a brief overview of a basic ChargeMaster installation.



Reading the user's manual is still necessary for safety instructions, additional features, best performance and years of trouble-free service. The ChargeMaster 1 manual is available at www.Mastervolt.com.

2



All electrical systems (DC and AC) must be disconnected from any power source during the entire installation! Use isolated tools!



Read the safety instructions (chapter 2 of the user's manual).

Safety regulations and measures

1. Install the charger according to the instructions in both the user's and installation manual.
2. Never use chargers at a location where there is danger of gas or dust explosions.
3. Connections and safety features must be executed according to locally applicable regulations.

Mastervolt cannot be held liable for:

- Damage resulting from the use of the battery charger;
- Possible errors in the included manual and the consequences of these;
- Use that is inconsistent with the purpose of the product.

3

Check the contents of the delivery.

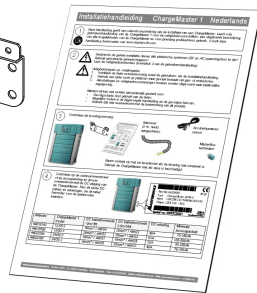
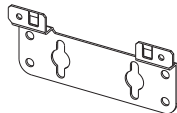

AC mains cable
(2m, attached
already)

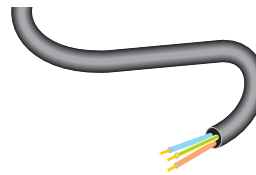

MasterBus
terminator



Battery
temperature
sensor

Contact your supplier if one of the items is missing.
Do not use the ChargeMaster if it is damaged.

4

Check from the identification label if the battery voltage and current matches the DC output of the ChargeMaster.

Choose the right DC wiring and fuses, see the table below for recommended values.



MASTERVOLT Part no : 44020300 CE IP 23

Type : ChargeMaster 24/30-3

Input : 120/230V AC 50/60 Hz 8.5A/4.2A

Output : 28.5VDC - 30A

Serial no: V822A0001 Design by Mastervolt Made in PRC

Part no	ChargeMaster 1 model	DC Cable cross section <2m/ 6ft	DC Cable cross section 2-5m/16ft	DC fuse	Minimum battery capacity
44010350	12/35-3	16mm ² / 4AWG	25mm ² / 2AWG	40A	70-350Ah
44010500	12/50-3	25mm ² / 2AWG	35mm ² / 1AWG	63A	100-500Ah
44020200	24/20-3	10mm ² / 6AWG	16mm ² / 4AWG	32A	50-250Ah
44020300	24/30-3	16mm ² / 4AWG	25mm ² / 2AWG	40A	70-350Ah

5

A

Mount the ChargeMaster 1 to the wall. Two ways are possible.

B

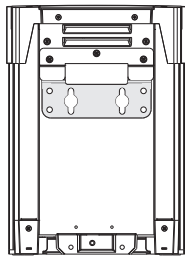

Mounting the bracket to the wall and fixing the ChargeMaster onto it.

Mounting the bracket to the ChargeMaster and hanging the ChargeMaster onto the wall.

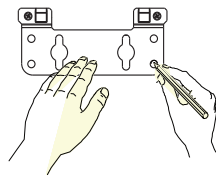
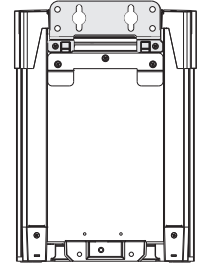

Use the dimensions on the back of this manual.

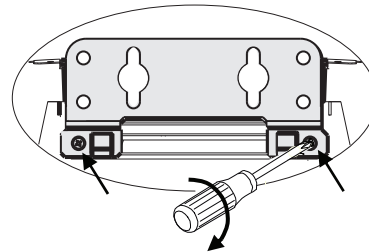
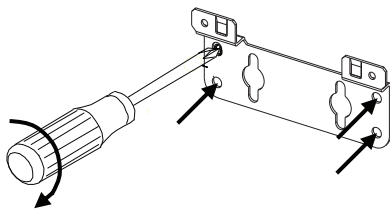
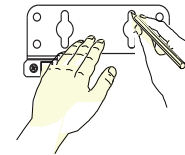

(B): take out the two screws before mounting the bracket.

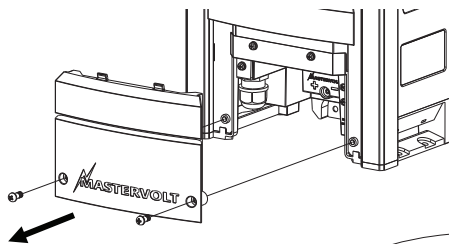
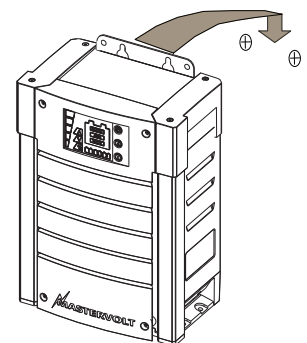
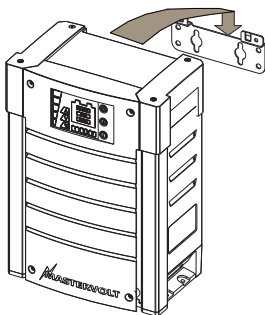

Fix the cabinet to the wall by fastening two screws at the lower side of the cabinet.

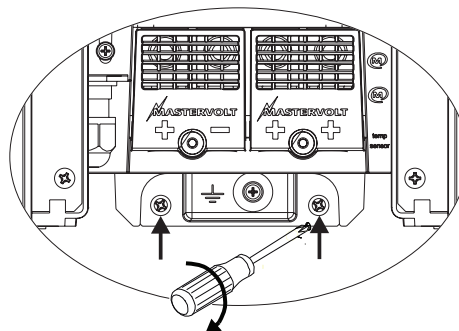

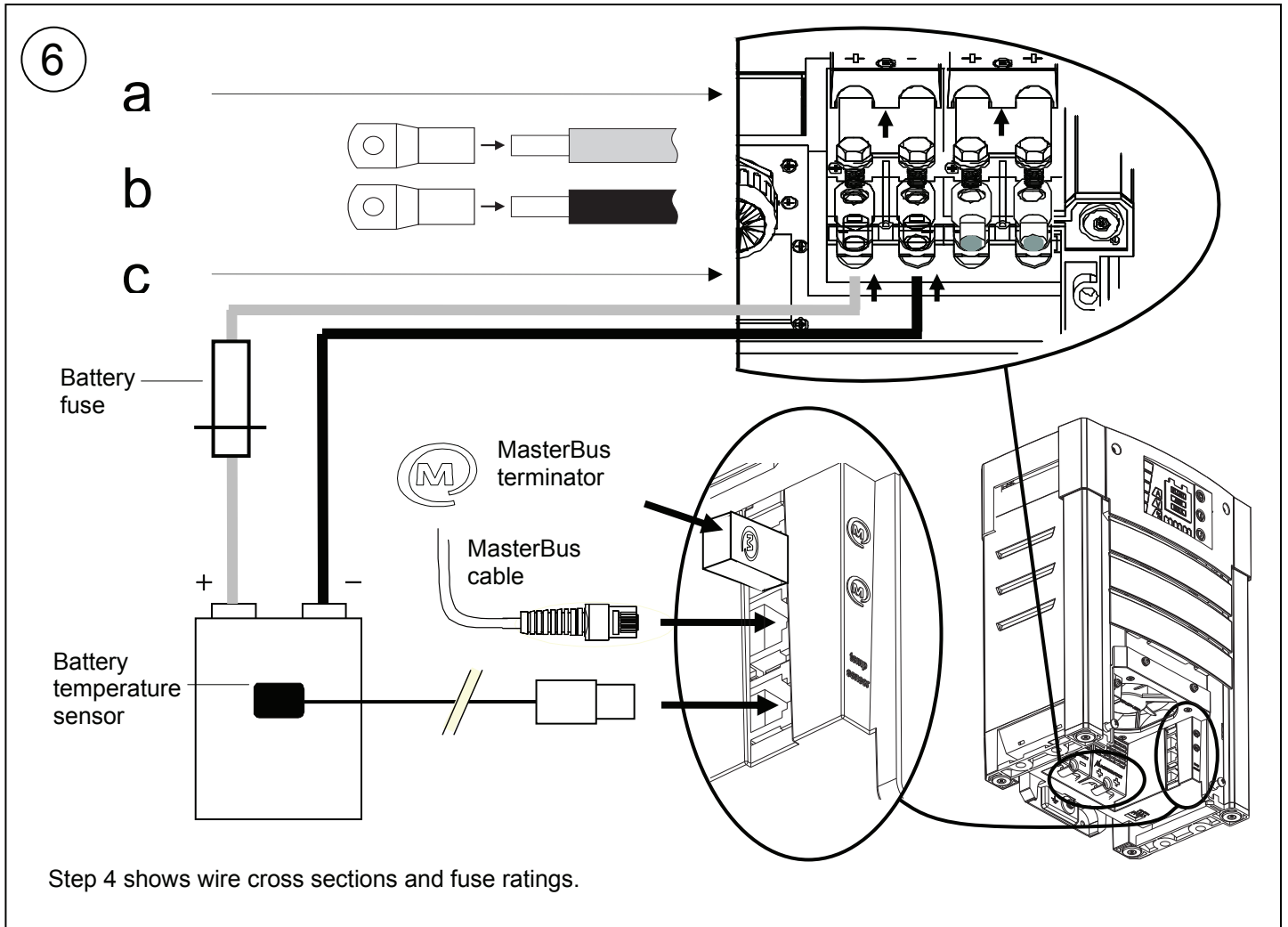

7 Change the Dipswitch settings if necessary.

Switch 1	Switch 2	
Wet battery	3step+ charging	Off
AGM, Gel, Spiral battery	Constant voltage charging (Float = 13.25/26.5V)	On

The diagram shows a hand adjusting four dipswitches labeled 1, 2, 3, and 4. A callout shows the internal battery compartment with a dipswitch labeled 'H-R00'.

dipswitches
1 2 3 4

See user's manual section 5.1 for Dip switch 3 and 4 settings.

8

The diagram shows a cable being plugged into the charger (a), a screw being tightened on the battery compartment (c), and a hand pressing the POWER button on the control panel (d). The control panel has buttons for FLOAT, ABS, BULK, and a POWER button. There are also indicator lights and buttons labeled A, V, and M.

a

b

c

d

Check all wiring; see step 6 for wiring details.

Hold POWER pressed for 3 seconds to switch On the charger.
POWER LED green = on, red = standby.
If a failure occurs, refer to the user's manual for error codes.

Model	12/35-3	12/50-3	24/20-3	24/30-3
Nominal input voltage:	120/230V	120/230V	120/230V	120/230V
Nominal input frequency:	50/60Hz	50/60Hz	50/60Hz	50/60Hz
Full load consumption:	575VA	825VA	660VA	925VA
Nominal output voltage:	12V	12V	24V	24V
Total maximum charge current:	35A at 14.4V	50A at 14.4V	20A at 28.8V	30A at 28.8V
Weight including cable and bracket:	4kg (9Lbs)	4kg (9Lbs)	4kg (9Lbs)	4kg (9Lbs)
DC consumption	<5mA	<5mA	<2.5mA	<2.5mA
Protection degree	IP23	IP23	IP23	IP23

Installation relevant specifications

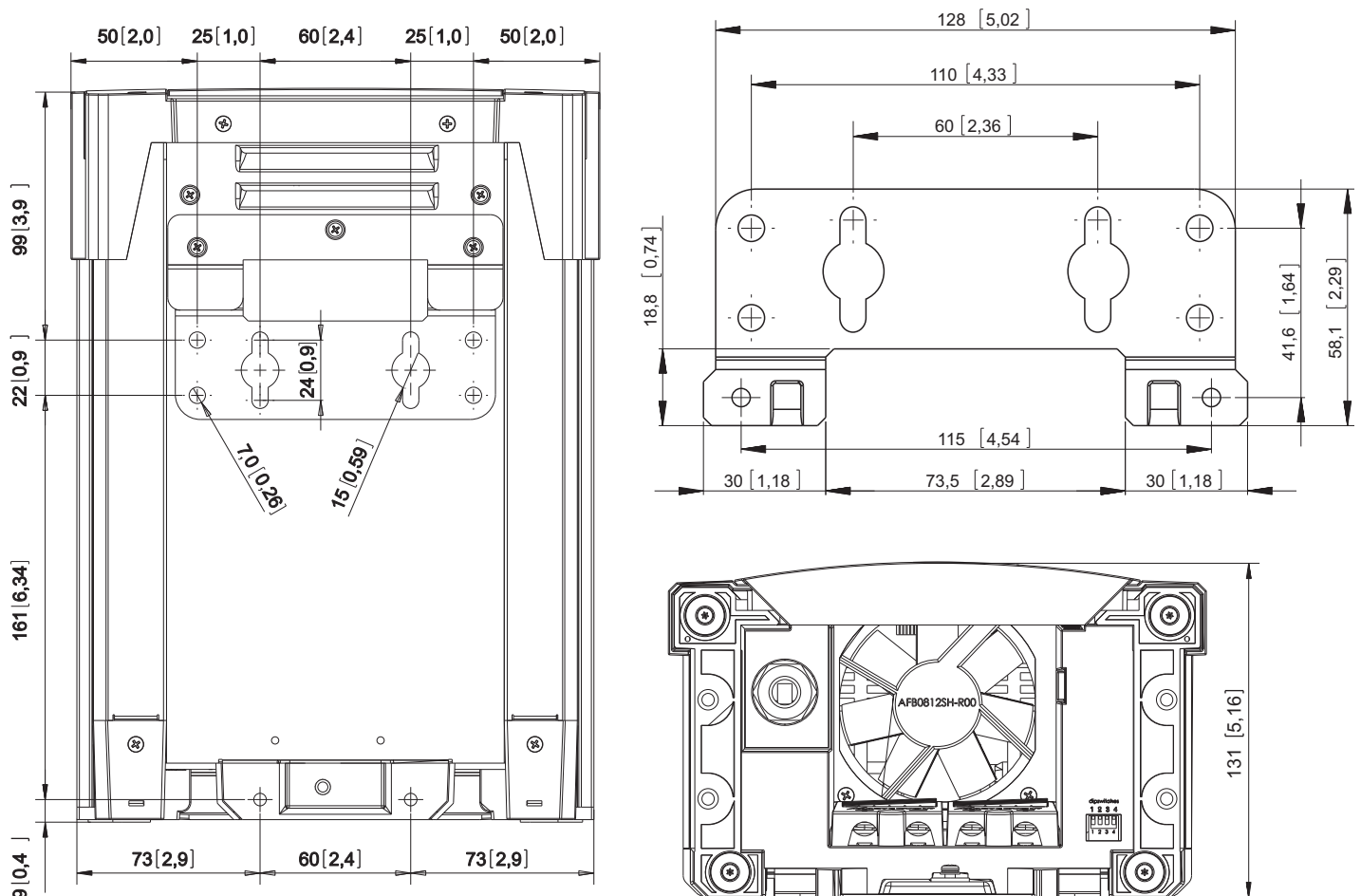

Installation dimensions in mm [inch]