

Custom 360 Panel Worksheet—Instructions

Use the Panel Layout Grid to record all module and component details required for your custom panel.

1. DRAW A BOX INDICATING THE PANEL FRAME SIZE AND ORIENTATION YOU WANT.

Choose from the selection of panel frame sizes and orientations illustrated on *Panel Frames Table*—page 3.

2. ON THE PANEL LAYOUT GRID, WRITE IN THE VOLTAGE RATING REQUESTED IN THE SPACE PROVIDED.

3. ON THE PANEL LAYOUT GRID, WRITE THE MODULE NAME AND NUMBER IN THE SPACE PROVIDED.

Choose from the selection of modules illustrated on *360 Panel Modules*—page 4.

4. FOR CIRCUIT BREAKER MODULES, WRITE IN THE SPACE PROVIDED:

a. The current rating for each circuit

Choose from the current ratings listed under the modules on *360 Panel Modules*—page 4.

b. The label number and label text for each circuit

Choose from over 500 *Standard labels* listed on *Standard Label List*—pages 5 and 6, or fill out the *Custom Label Order Form*—page 7 and 8.

5. FOR ALL OTHER MODULES, INDICATE MODULE PLACEMENT AND SPECIFY THE COMPONENTS TO BE INSTALLED.

Panel Layout Grid Worksheet Example

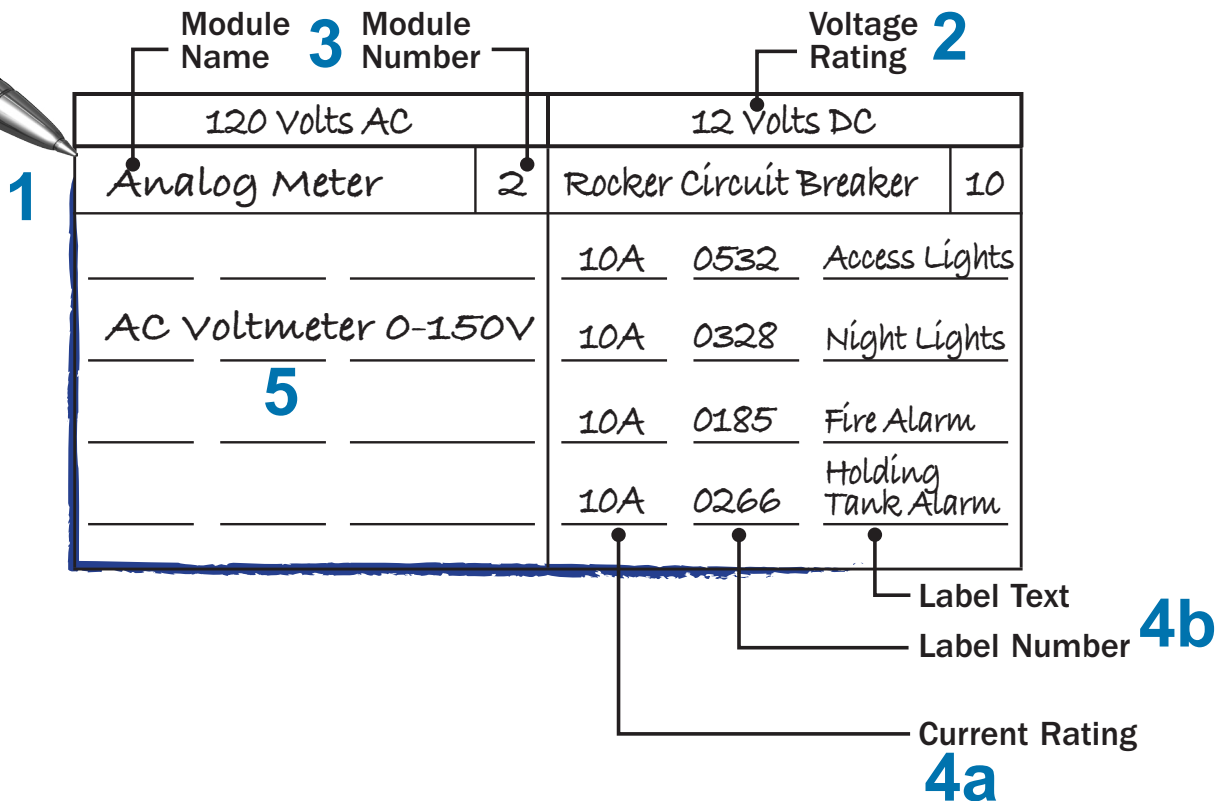

120 volts AC		12 Volts DC	
Analog Meter	2	Rocker Circuit Breaker	10
AC voltmeter 0-150V		10A	0532 Access Lights
5		10A	0328 Night Lights
		10A	0185 Fire Alarm
		10A	0266 Holding Tank Alarm

Callouts:

- 1: Points to the grid border.
- 2: Points to the voltage rating section.
- 3: Points to the module name and number section.
- 4a: Points to the current rating section.
- 4b: Points to the label text and label number section.

When all modules and components of your panel are recorded clearly on the *Panel Layout Grid*—page 2, please fax to (360)734-4195

Within 3 business days you will receive a price quote, and an estimated delivery date.

Custom 360 Panel Worksheet—Panel Layout Grid

1. Select circuit breaker style. Flat Rocker Restricted OFF Rocker Black Toggle White Toggle
Indicate exceptions at desired circuit breaker locations on the Panel Layout Grid below.

2. Select DC voltage if your panel includes DC circuits. 12V 24V

3. Select AC voltage if your panel includes AC circuits. 120V 230V 120/240V

4 3/4" (121mm)					
7 3/4" (197mm)					
10 3/4" (273mm)					
13 3/4" (349mm)					
16 3/4" (426mm)					
	4 7/8" (124 mm)	9 1/4" (235mm)	13 5/8" (346mm)	18" (457mm)	22 3/8" (568mm)

Record other panel details including wiring: _____

Contact _____

Company _____

Mailing address _____

Phone _____ Fax _____

E-mail _____

Date submitted by customer _____









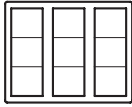

Please FAX completed worksheet to: (360) 734-4195

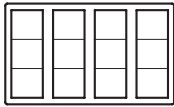
Phone: (360) 738-8230 E-mail: conductor@blueseasystem.com

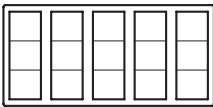
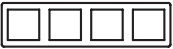
Reviewed by _____

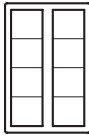
Date reviewed _____

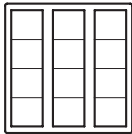
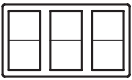
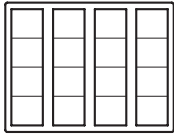
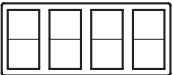
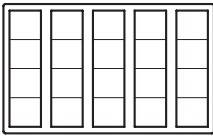
Custom 360 Panel Worksheet—Panel Frames Table

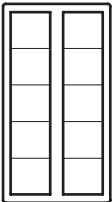
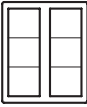
Panel Frames	Height in" (mm)	Width in" (mm)	Panel Frames	Height in" (mm)	Width in" (mm)
1 × 1 	4 3/4 (121)	4 7/8 (124)	3 × 3 	10 3/4 (273)	13 5/8 (346)
1 × 2 	4 3/4 (121)	9 1/4 (235)	3 × 4 	10 3/4 (273)	18 (457)
1 × 3 	4 3/4 (121)	13 5/8 (346)	3 × 5 	10 3/4 (273)	22 3/8 (568)
1 × 4 	4 3/4 (121)	18 (457)	4 × 1 	13 3/4 (349)	4 7/8 (124)
2 × 1 	7 3/4 (197)	4 7/8 (124)	4 × 2 	13 3/4 (349)	9 1/4 (235)
2 × 2 	7 3/4 (197)	9 1/4 (235)	4 × 3 	13 3/4 (349)	13 5/8 (346)
2 × 3 	7 3/4 (197)	13 5/8 (346)	4 × 4 	13 3/4 (349)	18 (457)
2 × 4 	7 3/4 (197)	18 (457)	4 × 5 	13 3/4 (349)	22 3/8 (568)
3 × 1 	10 3/4 (273)	4 7/8 (124)	5 × 2 	16 3/4 (426)	9 1/4 (235)
3 × 2 	10 3/4 (273)	9 1/4 (235)			

Custom 360 Panel Worksheet—360 Panel Modules

1. Digital Meter

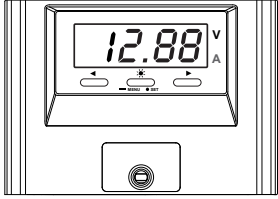

- Meters:**
- DC Voltmeter ^A: 0-60V
 - DC Voltmeter w/Alarm ^A: 0-60V
 - DC Ammeter: ^A500-500A
 - DC Multimeter w/Alarm ^A: ^A500-500A/0-60V
 - AC Voltmeter ^B: 80-270V
 - AC Ammeter ^B: 0-150A
 - AC Frequency Meter: 40-90Hz
 - AC Multimeter w/Alarm ^B: 0-150A, 80-270V, 0-35kW, 40-90Hz
- SWITCHES:**
- ^A Included: 3 DC Sources, ^B Optional: 2 AC Load Groups

2. Analog Meter

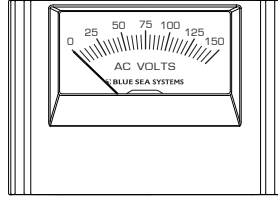

- Meters:**
- DC Voltmeters^A: 8-16V, 18-32V
 - DC Ammeters: 0-25A, 0-50A, 0-75A, 0-100A, 0-150A, 0-200A
 - DC Zero Center Ammeters: 50-0-50A, 100-0-100A
 - AC Voltmeters^B: 0-150V, 0-250V
 - AC Ammeters^B: 0-50A, 0-100A
- SWITCHES:**
- ^A Included: 3 DC Sources, ^B Optional: AC Load Groups

3. Analog DIN Meter

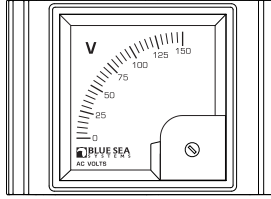

- Meters:**
- DC Voltmeters: 8-16V, 18-32V
 - DC Ammeters: 0-25A, 0-50A, 0-100A, 0-150A
 - AC Voltmeters: 0-150V, 0-250V
 - AC Ammeter: 0-50A

4. Vessel Systems Monitor VSM422[†]

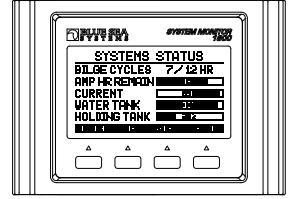

- Vessel Systems Monitor VSM422:**
- Four meters in one:
 - AC Multimeter, DC Multimeter, Tank Meter, Bilge Meter
 - Complete monitoring of 4 critical functions with 22 measurements identifying problems before they become emergencies
- [†] Available second quarter 2008

5. Gauge (DPDT Switch Included)

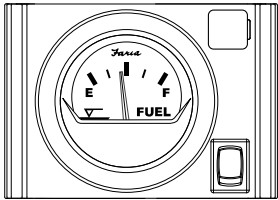

- Gauges:**
- Engine Temp: 100-250°F
 - Water Pressure: 0-30 PSI/kPa
 - Oil Pressure: 0-80 PSI/Bar
 - DC Voltmeter: 10-16V
 - DC Ammeter: 60-0-60A
 - Battery Condition
 - Fuel level
 - Tank Level
 - Potable Water Level
 - Hourmeter
 - Clock Analog

- Senders:**
- 1) Tank Level: 8-16" tank depth, 14-24" tank depth
 - 2) Engine Temperature: 1/8" input
 - 3) Oil Pressure: 80 PSI, 1/8" input

6. DC Push Button Circuit Breaker

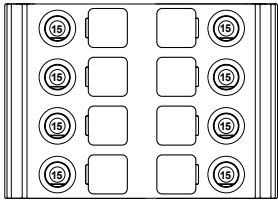

- Push Button Reset-Only Circuit Breakers:**
- 3A, 4A, 5A, 7A, 10A, 12A, 15A, 20A, 25A, 30A, 35A, 40A

7. DC Circuit Breaker + Rocker Switches

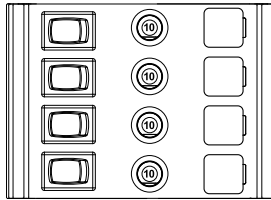

- Push Button Reset-Only Circuit Breakers:**
- 3A, 4A, 5A, 7A, 10A

- Rocker Switches:**
- SPST: ON-OFF ^A, (ON)-OFF ^A
 - SPDT: ON-OFF-ON ^B, ON-OFF-(ON) ^B, (ON)-OFF-(ON) ^B
 - DPST: ON-OFF ^C, ON-ON ^C
 - DPDT: ON-(ON) ^C, ON-OFF-ON ^C, ON-OFF-(ON) ^C, (ON)-OFF-(ON) ^C
- OPTIONAL SWITCHES:**
- ^A 10A Max@12V and 24V DC
 - ^B 10A Max@12V DC, 8A Max@24V DC
 - ^C 5A Max@12V and 24V DC

8. Remote Control Panels[†]

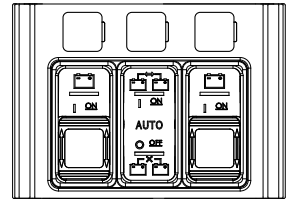

- Features:**
- Remote Battery Switch*—low amp switching
 - Automatic Charging Relay*—combines batteries for charging
 - Manage dual battery—one engine
 - Manage triple battery—two engines
- [†] Available second quarter 2008
* Not included

9. DC m-Series Battery Switch

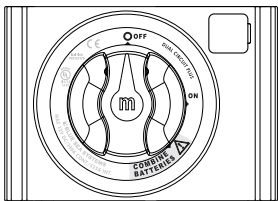

- m-Series Battery Switches:** (available in red or black)
- Single Circuit with Key
 - Single Circuit with Knob
 - Selector
 - Dual Circuit™
 - Dual Circuit Plus™

10. Rocker Circuit Breaker

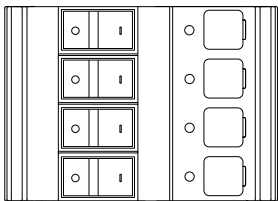

- Flat or Restricted OFF Rocker Circuit Breakers:**
- DC Single Pole: 5A, 8A, 10A, 15A, 20A, 25A, 30A, 40A, 50A, 60A, 80A, 100A
 - DC Double Pole: 150A, 175A, 200A
 - DC Triple Pole: 250A, 300A
 - AC Single Pole: 5A, 8A, 10A, 15A, 20A, 25A, 30A, 40A, 50A
 - AC Double Pole: 10A, 15A, 16A, 20A, 30A, 32A, 40A, 50A, 60A, 80A, 100A
 - AC Triple Pole: 50A, 60A, 80A, 100A

11. Toggle Circuit Breaker

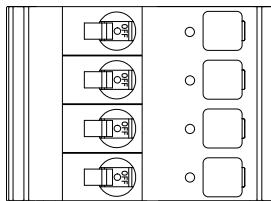

- Black or White Toggle Circuit Breakers:**
- DC Single Pole:** 5A, 8A, 10A, 15A, 20A, 25A, 30A, 40A, 50A
- AC Single Pole:** 5A, 8A, 10A, 15A, 20A, 25A, 30A, 40A, 50A
- AC Double Pole:** 10A, 15A, 16A, 20A, 30A, 32A, 40A, 50A

12. AC Lockout Slide Source Selector

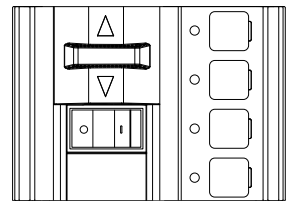

- Raised Rocker and Black Toggle Circuit Breakers:**
- 120 Volts:** 30A, 50A
- 230 Volts:** 16A, 32A
- 120/240 Volts (NOT SHOWN):** 50A, 60A, 80A, 100A (Requires 2 modules in a column)

13. 185 Series Circuit Breaker

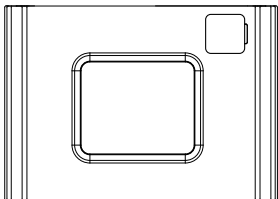

- 185 Series Circuit Breakers:**
- 25A, 30A, 35A, 40A, 50A, 60A, 70A, 80A, 90A, 100A, 110A, 120A, 135A, 150A

14. AC Residual Current Circuit Breaker

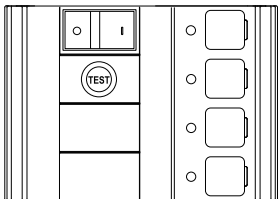

- RCBO/ELCI/GFCI:**
- 120 Volt,**
- 15A, 1 Pole, 5mA ground fault trip current
 - 30A, 2 Pole, 30mA ground fault trip current

15. AC Rotary Switch Source Selector

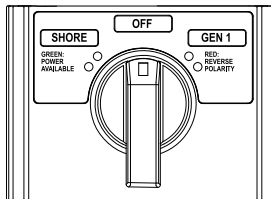

- Rotary Switches:**
- 30A: 2 position + Off, 4 Pole
 - 30A: 2 position + Off, 2 Pole
 - 30A: 3 position + Off, 2 Pole
 - 65A: 2 position + Off, 2 Pole
 - 65A: 2 position + Off, 3 Pole
 - 65A: 2 position + Off, 4 Pole
 - 65A: 3 position + Off, 3 Pole

16. Blank 17. 12 Volt Sockets

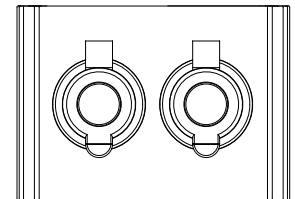

- Blank—used to mount accessories
- 12 Volt Sockets—15A rating per socket

Custom 360 Panel Worksheet—Standard Label List

Label No.	Label Text	Label No.	Label Text	Label No.	Label Text	Label No.	Label Text
1	#1	52	BATTERY COMPARTMENT	116	CREW QUARTERS	183	FAX
2	#2	53	BATTERY PARALLEL	117	DAVIT	184	FILLING PUMP
3	(BLANK)	560	BATTERY SWITCH	119	DC MAIN	185	FIRE ALARM
5	12 VOLT DC	54	BEACON	122	DC SUB PANEL	186	FIRE EXT
499	12 VOLT OUTLETS INSIDE	480	BEDROOM	118	DC LIGHTS	187	FIRE HORN
500	12 VOLT OUTLETS OUTSIDE	485	BEDROOM SLIDEOUT	120	DC OUTLETS	459	FISH FINDER
516	120/240V 60HZ	55	BILGE	121	DC REFRIGERATOR	538	FISHBOX DRAIN
517	120/240V 60HZ SHORE POWER	56	BILGE ALARM	123	DECK	188	FISHBOX ICE MAKER
502	120V 60HZ SHORE POWER	57	BILGE ALARM 2	124	DECK LIGHTS	520	FISHBOX PUMP
7	120V AC/60 HZ	58	BILGE ALARM 3	125	DECK LIGHTS AFT	521	FISHBOX REFRIG
6	120V AC OUTLETS	59	BILGE ALARM 4	126	DECK LIGHTS FWD	189	FISHING LIGHT
4	12V DC OUTLETS	60	BILGE LIGHTS	127	DECK LIGHTS PORT	487	FISHWELL PUMP
526	230 V AC/50 HZ	61	BILGE PUMP	128	DECK LIGHTS STBD	488	FISHWELL PUMP 2
10	24 VOLT DC	62	BILGE PUMP 2	129	DEFROSTER	190	FLOOD LIGHTS
460	240 V AC/60 HZ	63	BILGE PUMP 3	130	DEPTH RECORDER	191	FLOSCAN
8	240 VOLTS AC	64	BILGE PUMP 4	131	DEPTH SOUNDER	192	FLYBRIDGE
9	24V DC OUTLETS	453	BILGE PUMP ON-OFF-AUTO	132	DEPTH/SPEED	193	FLYBRIDGE ELECTRONICS
468	250 V AC/50 HZ	65	BLOWER	133	DESALINATOR	194	FLYBRIDGE LIGHTS
515	250V 50HZ SHORE POWER	66	BOAT DAVIT	134	DIMMER	195	FLYBRIDGE OUTLETS
462	AC BUS 1	67	BOOM LIGHT	135	DINING AREA LIGHTS	196	FOG LIGHTS
11	AC COMPRESSOR	68	BOW LIGHT	136	DINING AREA OUTLETS	197	FOREDECK LIGHT
12	AC FAN	69	BOW THRUSTER	137	DISCHARGE PUMP	539	FORWARD BILGE
13	AC MAIN	70	BRIDGE	138	DISH WASHER	198	FREEZER
17	AC SUB PANEL	71	BRIDGE INST	139	DISPOSAL	199	FRESH WATER
14	AC PANEL	72	BRIDGE LIGHTS	140	DIVE COMPRESSOR	200	FRESH WATER PUMP
15	AC POWER	73	BRIDGE OUTLETS	141	DOCKING LIGHT PORT	201	FRESH WATER PUMP 2
16	AC REFRIGERATOR	74	CABIN	142	DOCKING LIGHT STBD	202	FRESH WATER PUMP 3
532	ACCENT LIGHT	75	CABIN 2	143	DOCKING LIGHTS	203	FRESH WATER PUMP 4
18	ACCESSORY	501	CABIN 2 FAN	144	DOWN RIGGER	204	FRESH WATER WASH
19	ADF	76	CABIN 2 LIGHTS	145	DRYER	482	FRONT SLIDEOUT
20	AERATOR	77	CABIN 2 OUTLETS	146	DUMP VALVES	561	FUEL GAUGE
21	AFT CABIN	78	CABIN 3	566	ECU	205	FUEL PRIMER PUMP
22	AFT CABIN LIGHTS	79	CABIN 3 LIGHTS	148	ELECTRONICS	206	FUEL PUMP
23	AFT CABIN OUTLETS	80	CABIN 3 OUTLETS	469	ELECT CONTROL UNIT	207	FUEL PUMP 2
536	AFT CABIN SUMP	81	CABIN 4	147	ELECTRIC HATCH	208	FUEL PUMP 3
530	AFT DISCHARGE PUMP	82	CABIN 4 LIGHTS	150	EMERGENCY LIGHTS	209	FUEL PUMP 4
24	AFT HEAD	83	CABIN 4 OUTLETS	151	EMERGENCY PUMPS	210	FUEL TANK HEATER
25	AIR COMPRESSOR	84	CABIN FAN	149	EMERG. BACKUP SYSTEM	211	FUEL TRANSFER
26	AIR CONDITIONER	85	CABIN HEATER	547	ENG 1/ENG 2	507	FUME DETECTOR
27	AIR CONDIT 2	86	CABIN LIGHTS	152	ENG. RM. BILGE ALARM	212	FURLER JIB
28	AIR CONDIT 3	87	CABIN OUTLETS	157	ENG. RM. PANEL MAIN	213	FURLER MAINSAIL
29	AIR CONDIT 4	88	CABLE MASTER	545	ENGINE	214	FURLER SPINNAKER
30	AIR CONDIT PUMP	89	CASSETTE PLAYER	158	ENGINE ALARM	215	FURNACE
31	AIR HORN	90	CB RADIO	159	ENGINE BLOCK HEATER	216	FWD CABIN
544	ALARM	91	CCTV	160	ENGINE CONTROL PORT	217	FWD CABIN LIGHTS
32	ALARM SYSTEM	92	CD PLAYER	161	ENGINE CONTROL STBD	218	FWD CABIN OUTLETS
33	ALT DISCONNECT	93	CELLULAR PHONE	162	ENGINE CONTROLS	529	FWD DISCHARGE PUMP
461	ALTERNATOR	537	CENTER LIVEWELL	163	ENGINE DRIVEN REFRIG	528	FWD HEAD
34	AMPLIFIER	94	CHARGER/INVERTER	164	ENGINE EXHAUST FAN	219	GALLEY
35	ANCHOR LIGHT	95	CHART LIGHT	165	ENGINE HATCH	220	GALLEY APPLIANCES
36	ANCHOR LIGHT MAIN	96	CHART PLOTTER	166	ENGINE HEATER PORT	221	GALLEY DRAIN
37	ANCHOR LIGHT MIZZEN	97	CHOKE	167	ENGINE HEATER STBD	222	GALLEY FAN
38	ANCHOR WASH DOWN	98	CIRCULATOR PUMP	168	ENGINE INST	223	GALLEY LIGHTS
39	APPLIANCES	508	CLOCK	169	ENGINE OIL PAN PUMP	224	GALLEY OUTLETS
40	ARCH LIGHTS	99	CLOSET LIGHT	153	ENGINE ROOM BLOWER	490	GALVANIC ISOLATOR
41	AUDIO/VIDEO SYSTEM	100	COCKPIT LIGHTS	154	ENGINE ROOM HEATER	225	GARBAGE DISPOSAL
525	AUTO FILL	101	COCKPIT REFRIGERATOR	155	ENGINE ROOM LIGHTS	226	GAS ALARM
43	AUTO-PILOT	102	COLOR SOUNDER	156	ENGINE ROOM OUTLETS	228	GEN 1
555	AUTO/MAN	103	COMM ELECTRONICS	170	ENGINE SHUTDOWN	229	GEN 2
42	AUTO/MANUAL	104	COMPARTMENT HEATER	171	ENGINE TEMP	454	GEN OFF-ON-START
524	AUTOMATIC CHARGING RELAY	105	COMPARTMENT LIGHT	546	ENGINES	230	GEN ROOM BLOWER
44	BAIT PUMP	106	COMPASS LIGHT	172	ENTERTAINMENT CENTER	466	GEN RUNNING
45	BAIT WELL	107	COMPUTER	173	ENTRANCE DOOR	455	GEN STOP
46	BALLAST CONTROLS	514	COMPUTER DISPLAY	174	ENTRY STEP	227	GENERAL PURPOSE
47	BALLAST PUMP	108	CONDENSER PUMP	175	EXHAUST FAN	523	GENERATOR
48	BAR	109	CONSOLE LIGHT	176	EXHAUST TEMP	231	GFI OUTLET
481	BATHROOM	110	CONVERTER	177	EXTERIOR	232	GPS
49	BATTERY	111	COOKING GRILL	178	EXTERIOR LIGHTS	233	GPS/LORAN
473	BATTERY 1	112	COOKTOP	179	FAN	234	GPS/PLOTTER
474	BATTERY 2	113	COOLING PUMP	180	FAN 2	510	GUN LOCKS
50	BATTERY CHARGER	114	COURTESY LIGHTS	181	FAN 3	235	GYRO COMPASS
51	BATTERY CHARGER 2	115	CREW LIGHTS	182	FAN 4	236	HAILER

Custom 360 Panel Worksheet—Standard Label List *continued*

Label No.	Label Text	Label No.	Label Text	Label No.	Label Text	Label No.	Label Text
237	HALLWAY LIGHTS	494	LIGHTS AFT CABIN	347	RACK LIGHTS	409	SUB PANEL
238	HALON FIRE SYSTEM	297	LIGHTS FWD	348	RACK OUTLETS	410	SUMP PUMP
239	HAM RADIO	493	LIGHTS MASTER CABIN	349	RADAR	411	SUMP PUMP 2
240	HEAD	495	LIGHTS PANTRY	350	RADAR ARCH LIGHTS	412	SYNCHRO
241	HEAD 2	492	LIGHTS PILOT HOUSE	351	RADIO	564	TANK GAUGE
242	HEAD 2 FAN	298	LIGHTS PORT	352	RANGE	413	TAPE DECK
243	HEAD 2 OUTLETS	491	LIGHTS SETTEE	353	RDF	414	TELEPHONE SYSTEM
244	HEAD 3	299	LIGHTS STBD	483	REAR SLIDEOUT	415	TEST
245	HEAD 3 FAN	300	LIVWELL	354	RECEIVER	416	TOWING LIGHTS
246	HEAD 3 OUTLETS	301	LIVWELL INPUT	355	RECEPTACLE	417	TRACK LIGHTS
247	HEAD 4	302	LIVWELL OUTPUT	356	REFRIGERATOR	419	TRANSFORMER
248	HEAD 4 FAN	303	LOCKER LIGHTS	357	REFRIGERATOR PUMP	518	TRANSFORMER SECONDARY
249	HEAD 4 OUTLETS	304	LOG	358	REFRIGERATOR/FREEZER	465	TRANSFER
250	HEAD FAN	305	LORAN	359	REGULATOR	418	TRANSFER PUMP
251	HEAD LIGHTS	306	LPG CONTROL	360	REVERSE POLARITY	420	TRASH COMPACTOR
256	HEAD LIGHTS	307	LUBE OIL PUMP	361	ROD LOCKER	478	TRAVEL LOCKS
252	HEAD LIGHTS 2	308	MACERATOR PUMP	489	RUDDER ANGLE INDICATOR	421	TRICOLOR LIGHT
253	HEAD LIGHTS 3	309	MAIN	362	RUNNING LIGHTS	422	TRIM TABS
254	HEAD LIGHTS 4	314	MAIN SAIL FURLING	363	SAILING CONTROLS	527	TROLLING MOTOR
255	HEAD OUTLETS	310	MAIN BREAKER	364	SAILING INST	423	TV
257	HEATER	311	MAIN CABIN	365	SALOON	424	TV ANTENNA
519	HEATER & AIR CONDIT	312	MAIN CABIN LIGHTS	366	SALOON HEATER	425	TV/STEREO
258	HEATER 2	313	MAIN CABIN OUTLETS	367	SALOON LIGHTS	426	TV/VCR
259	HEATER 3	315	MAP LIGHT	368	SALOON OUTLETS	535	UNDERWATER LIGHT
260	HEATER 4	316	MAST LIGHTS	369	SALT WATER PUMP	427	UPS SYSTEM
261	HELM ELECTRONICS	317	MASTHEAD LIGHT	370	SAT/COM	428	UTILITY
262	HELM GAUGES	551	MEMORY	371	SAT/NAV	429	VACUUM
263	HELM INST	318	MICROWAVE	372	SATELLITE DISH	430	VACUUM PUMP
264	HIGH WATER ALARM	319	MINI DISC PLAYER	373	SCRUBBER	431	VCR
265	HOLDING TANK	320	MIZZEN FLOOD	374	SEARCH LIGHT	432	VHF
266	HOLDING TANK ALARM	325	NAV ELECTRONICS	375	SEARCH LIGHT HAND	511	VHF 1
267	HOLDING TANK PUMP	326	NAV INST	376	SEARCH LIGHT REMOTE	512	VHF 2
268	HOOD FAN	456	NAV LIGHT ANCHOR-OFF-NAV	377	SEAWATER TEMP	433	VIDEO PLOTTER
269	HOOD LIGHT	327	NAV LIGHTS	378	SEAWATER WASHDOWN	434	VIDEO SYSTEM
270	HORN	321	NAV STATION ELECT	379	SECURITY SYSTEM	543	WASHDOWN
475	HOT TUB	322	NAV STATION GAUGES	380	SHIP	513	WASHDOWN PUMP
271	HOT WATER PUMP	323	NAV STATION INST	381	SHORE	435	WASHER
548	HOUSE	324	NAV STATION LIGHTS	463	SHORE 1	436	WASHER/DRYER
549	HOUSE/ENG	565	NETWORK	464	SHORE 2	437	WATER ALARM
550	HOUSE/GEN	328	NIGHT LIGHTS	382	SHORE CORD REEL	562	WATER GAUGE
272	HYDRAULIC ALARM	329	OFF	383	SHORE POWER	438	WATER HEATER
273	HYDRAULIC SYSTEM	331	OIL CHANGE PUMP	384	SHORE POWER CORD	439	WATER LEVEL
274	HYDRAULIC TANK ALARM	563	OIL GAUGE	385	SHOWER SUMP PUMP	440	WATER MAKER
275	ICE MAKER	332	ON	386	SINK DRAIN	441	WATER PRESSURE
276	IGNITION	330	ON-OFF	486	SLIDEOUT	442	WATER PUMP
277	IGNITION PORT	333	OUTLETS	387	SOLAR PANEL	443	WEATHER FAX
278	IGNITION STBD	334	OUTLETS 2	388	SONAR	444	WEATHER INST
279	INST LIGHTS	335	OUTLETS 3	542	SONAR/ACC	559	White (BLANK)
280	INSTRUMENTS	336	OUTLETS 4	389	SPARE	553	WINCH
281	INTERCOM	505	OUTLETS AFT	390	SPEED/LOG	445	WINCHES
282	INTERCOM HAILER	337	OUTLETS DECK	392	SPREADER LIGHT MIZZEN	477	WIND GEN
283	INTERCOM/TELEPHONE	506	OUTLETS ENGINE ROOM	391	SPREADER LIGHTS	446	WIND INST
284	INTERIOR LIGHTS	338	OUTLETS EXTERIOR	393	SSB	522	WINDSHIELD VENT
556	INTERNET	503	OUTLETS FORWARD	394	STABILIZER	449	WINDSHIELD WASHER
285	INVERTER	339	OUTLETS INTERIOR	558	STAIR LIGHT	447	WINDEX LIGHT
467	INVERTER 2	504	OUTLETS PILOT HOUSE	395	STARBOARD	448	WINDLASS
476	INVERTER AC BUS	458	PANEL LIGHTS	396	START	472	WIPER CENTER
471	INVERTER AC SUPPLY	496	PILOT HOUSE FAN	398	START PORT	450	WIPER PORT
470	INVERTER DC SUPPLY	340	PORT	399	START STBD	451	WIPER STBD
286	INVERTER OUTLET	540	PORT FISHBOX	397	START STOP	452	WIPERS
287	ISOLATION TRANSFORMER	534	PORT LIVWELL	541	STBD FISHBOX	557	WIRELESS
479	KITCHEN	341	PORT THRUSTER	533	STBD LIVWELL		
484	KITCHEN SLIDEOUT	552	PORT/STBD ENG	400	STBD THRUSTER		
288	KNOT METER	342	POWER	401	STEAMING LIGHT		
289	LAZARETTE LIGHTS	343	POWER WASHER	402	STEP LIGHT		
290	LECTRASAN	457	PREHEAT	403	STEREO		
291	LIGHTER	344	PRIMARY WINCHES	404	STERN LIGHT		
292	LIGHTS	345	PRINTER	509	STERN THRUSTER		
293	LIGHTS 2	346	PUMP	405	STOP		
294	LIGHTS 3	497	PUMP BLACK WATER	406	STOVE		
295	LIGHTS 4	498	PUMP GRAY WATER	407	STOVE/MICROWAVE		
296	LIGHTS AFT	554	PUMP OUT	408	STROBE LIGHT		

Custom 360 Panel Worksheet—Custom Label Order Form

Please PRINT clearly in Label Templates provided below.

<table border="1"><tr><td> </td><td> </td><td> </td><td> </td><td> </td><td> </td><td> </td><td> </td><td> </td><td> </td></tr><tr><td> </td><td> </td><td> </td><td> </td><td> </td><td> </td><td> </td><td> </td><td> </td><td> </td></tr><tr><td> </td><td> </td><td> </td><td> </td><td> </td><td> </td><td> </td><td> </td><td> </td><td> </td></tr></table>																															<table border="1"><tr><td> </td><td> </td><td> </td><td> </td><td> </td><td> </td><td> </td><td> </td><td> </td><td> </td></tr><tr><td> </td><td> </td><td> </td><td> </td><td> </td><td> </td><td> </td><td> </td><td> </td><td> </td></tr><tr><td> </td><td> </td><td> </td><td> </td><td> </td><td> </td><td> </td><td> </td><td> </td><td> </td></tr></table>																															<table border="1"><tr><td> </td><td> </td><td> </td><td> </td><td> </td><td> </td><td> </td><td> </td><td> </td><td> </td></tr><tr><td> </td><td> </td><td> </td><td> </td><td> </td><td> </td><td> </td><td> </td><td> </td><td> </td></tr><tr><td> </td><td> </td><td> </td><td> </td><td> </td><td> </td><td> </td><td> </td><td> </td><td> </td></tr></table>																															<table border="1"><tr><td> </td><td> </td><td> </td><td> </td><td> </td><td> </td><td> </td><td> </td><td> </td><td> </td></tr><tr><td> </td><td> </td><td> </td><td> </td><td> </td><td> </td><td> </td><td> </td><td> </td><td> </td></tr><tr><td> </td><td> </td><td> </td><td> </td><td> </td><td> </td><td> </td><td> </td><td> </td><td> </td></tr></table>																															<table border="1"><tr><td> </td><td> </td><td> </td><td> </td><td> </td><td> </td><td> </td><td> </td><td> </td><td> </td></tr><tr><td> </td><td> </td><td> </td><td> </td><td> </td><td> </td><td> </td><td> </td><td> </td><td> </td></tr><tr><td> </td><td> </td><td> </td><td> </td><td> </td><td> </td><td> </td><td> </td><td> </td><td> </td></tr></table>																														
<table border="1"><tr><td> </td><td> </td><td> </td><td> </td><td> </td><td> </td><td> </td><td> </td><td> </td><td> </td></tr><tr><td> </td><td> </td><td> </td><td> </td><td> </td><td> </td><td> </td><td> </td><td> </td><td> </td></tr><tr><td> </td><td> </td><td> </td><td> </td><td> </td><td> </td><td> </td><td> </td><td> </td><td> </td></tr></table>																															<table border="1"><tr><td> </td><td> </td><td> </td><td> </td><td> </td><td> </td><td> </td><td> </td><td> </td><td> </td></tr><tr><td> </td><td> </td><td> </td><td> </td><td> </td><td> </td><td> </td><td> </td><td> </td><td> </td></tr><tr><td> </td><td> </td><td> </td><td> </td><td> </td><td> </td><td> </td><td> </td><td> </td><td> </td></tr></table>																															<table border="1"><tr><td> </td><td> </td><td> </td><td> </td><td> </td><td> </td><td> </td><td> </td><td> </td><td> </td></tr><tr><td> </td><td> </td><td> </td><td> </td><td> </td><td> </td><td> </td><td> </td><td> </td><td> </td></tr><tr><td> </td><td> </td><td> </td><td> </td><td> </td><td> </td><td> </td><td> </td><td> </td><td> </td></tr></table>																															<table border="1"><tr><td> </td><td> </td><td> </td><td> </td><td> </td><td> </td><td> </td><td> </td><td> </td><td> </td></tr><tr><td> </td><td> </td><td> </td><td> </td><td> </td><td> </td><td> </td><td> </td><td> </td><td> </td></tr><tr><td> </td><td> </td><td> </td><td> </td><td> </td><td> </td><td> </td><td> </td><td> </td><td> </td></tr></table>																															<table border="1"><tr><td> </td><td> </td><td> </td><td> </td><td> </td><td> </td><td> </td><td> </td><td> </td><td> </td></tr><tr><td> </td><td> </td><td> </td><td> </td><td> </td><td> </td><td> </td><td> </td><td> </td><td> </td></tr><tr><td> </td><td> </td><td> </td><td> </td><td> </td><td> </td><td> </td><td> </td><td> </td><td> </td></tr></table>																														
<table border="1"><tr><td> </td><td> </td><td> </td><td> </td><td> </td><td> </td><td> </td><td> </td><td> </td><td> </td></tr><tr><td> </td><td> </td><td> </td><td> </td><td> </td><td> </td><td> </td><td> </td><td> </td><td> </td></tr><tr><td> </td><td> </td><td> </td><td> </td><td> </td><td> </td><td> </td><td> </td><td> </td><td> </td></tr></table>																															<table border="1"><tr><td> </td><td> </td><td> </td><td> </td><td> </td><td> </td><td> </td><td> </td><td> </td><td> </td></tr><tr><td> </td><td> </td><td> </td><td> </td><td> </td><td> </td><td> </td><td> </td><td> </td><td> </td></tr><tr><td> </td><td> </td><td> </td><td> </td><td> </td><td> </td><td> </td><td> </td><td> </td><td> </td></tr></table>																															<table border="1"><tr><td> </td><td> </td><td> </td><td> </td><td> </td><td> </td><td> </td><td> </td><td> </td><td> </td></tr><tr><td> </td><td> </td><td> </td><td> </td><td> </td><td> </td><td> </td><td> </td><td> </td><td> </td></tr><tr><td> </td><td> </td><td> </td><td> </td><td> </td><td> </td><td> </td><td> </td><td> </td><td> </td></tr></table>																															<table border="1"><tr><td> </td><td> </td><td> </td><td> </td><td> </td><td> </td><td> </td><td> </td><td> </td><td> </td></tr><tr><td> </td><td> </td><td> </td><td> </td><td> </td><td> </td><td> </td><td> </td><td> </td><td> </td></tr><tr><td> </td><td> </td><td> </td><td> </td><td> </td><td> </td><td> </td><td> </td><td> </td><td> </td></tr></table>																															<table border="1"><tr><td> </td><td> </td><td> </td><td> </td><td> </td><td> </td><td> </td><td> </td><td> </td><td> </td></tr><tr><td> </td><td> </td><td> </td><td> </td><td> </td><td> </td><td> </td><td> </td><td> </td><td> </td></tr><tr><td> </td><td> </td><td> </td><td> </td><td> </td><td> </td><td> </td><td> </td><td> </td><td> </td></tr></table>																														
<table border="1"><tr><td> </td><td> </td><td> </td><td> </td><td> </td><td> </td><td> </td><td> </td><td> </td><td> </td></tr><tr><td> </td><td> </td><td> </td><td> </td><td> </td><td> </td><td> </td><td> </td><td> </td><td> </td></tr><tr><td> </td><td> </td><td> </td><td> </td><td> </td><td> </td><td> </td><td> </td><td> </td><td> </td></tr></table>																															<table border="1"><tr><td> </td><td> </td><td> </td><td> </td><td> </td><td> </td><td> </td><td> </td><td> </td><td> </td></tr><tr><td> </td><td> </td><td> </td><td> </td><td> </td><td> </td><td> </td><td> </td><td> </td><td> </td></tr><tr><td> </td><td> </td><td> </td><td> </td><td> </td><td> </td><td> </td><td> </td><td> </td><td> </td></tr></table>																															<table border="1"><tr><td> </td><td> </td><td> </td><td> </td><td> </td><td> </td><td> </td><td> </td><td> </td><td> </td></tr><tr><td> </td><td> </td><td> </td><td> </td><td> </td><td> </td><td> </td><td> </td><td> </td><td> </td></tr><tr><td> </td><td> </td><td> </td><td> </td><td> </td><td> </td><td> </td><td> </td><td> </td><td> </td></tr></table>																															<table border="1"><tr><td> </td><td> </td><td> </td><td> </td><td> </td><td> </td><td> </td><td> </td><td> </td><td> </td></tr><tr><td> </td><td> </td><td> </td><td> </td><td> </td><td> </td><td> </td><td> </td><td> </td><td> </td></tr><tr><td> </td><td> </td><td> </td><td> </td><td> </td><td> </td><td> </td><td> </td><td> </td><td> </td></tr></table>																															<table border="1"><tr><td> </td><td> </td><td> </td><td> </td><td> </td><td> </td><td> </td><td> </td><td> </td><td> </td></tr><tr><td> </td><td> </td><td> </td><td> </td><td> </td><td> </td><td> </td><td> </td><td> </td><td> </td></tr><tr><td> </td><td> </td><td> </td><td> </td><td> </td><td> </td><td> </td><td> </td><td> </td><td> </td></tr></table>																														
<table border="1"><tr><td> </td><td> </td><td> </td><td> </td><td> </td><td> </td><td> </td><td> </td><td> </td><td> </td></tr><tr><td> </td><td> </td><td> </td><td> </td><td> </td><td> </td><td> </td><td> </td><td> </td><td> </td></tr><tr><td> </td><td> </td><td> </td><td> </td><td> </td><td> </td><td> </td><td> </td><td> </td><td> </td></tr></table>																															<table border="1"><tr><td> </td><td> </td><td> </td><td> </td><td> </td><td> </td><td> </td><td> </td><td> </td><td> </td></tr><tr><td> </td><td> </td><td> </td><td> </td><td> </td><td> </td><td> </td><td> </td><td> </td><td> </td></tr><tr><td> </td><td> </td><td> </td><td> </td><td> </td><td> </td><td> </td><td> </td><td> </td><td> </td></tr></table>																															<table border="1"><tr><td> </td><td> </td><td> </td><td> </td><td> </td><td> </td><td> </td><td> </td><td> </td><td> </td></tr><tr><td> </td><td> </td><td> </td><td> </td><td> </td><td> </td><td> </td><td> </td><td> </td><td> </td></tr><tr><td> </td><td> </td><td> </td><td> </td><td> </td><td> </td><td> </td><td> </td><td> </td><td> </td></tr></table>																															<table border="1"><tr><td> </td><td> </td><td> </td><td> </td><td> </td><td> </td><td> </td><td> </td><td> </td><td> </td></tr><tr><td> </td><td> </td><td> </td><td> </td><td> </td><td> </td><td> </td><td> </td><td> </td><td> </td></tr><tr><td> </td><td> </td><td> </td><td> </td><td> </td><td> </td><td> </td><td> </td><td> </td><td> </td></tr></table>																															<table border="1"><tr><td> </td><td> </td><td> </td><td> </td><td> </td><td> </td><td> </td><td> </td><td> </td><td> </td></tr><tr><td> </td><td> </td><td> </td><td> </td><td> </td><td> </td><td> </td><td> </td><td> </td><td> </td></tr><tr><td> </td><td> </td><td> </td><td> </td><td> </td><td> </td><td> </td><td> </td><td> </td><td> </td></tr></table>																														

You are solely responsible for spelling and text breaks. A signed copy of this form must be returned electronically or via fax before your order can be processed.

Date _____

Signature _____

Additional Label Templates on page 8



Custom 360 Panel Worksheet—Custom Label Order Form *continued*

<table border="1"><tr><td> </td><td> </td><td> </td><td> </td><td> </td><td> </td><td> </td><td> </td><td> </td><td> </td><td> </td><td> </td><td> </td><td> </td><td> </td><td> </td><td> </td><td> </td><td> </td><td> </td></tr><tr><td> </td><td> </td><td> </td><td> </td><td> </td><td> </td><td> </td><td> </td><td> </td><td> </td><td> </td><td> </td><td> </td><td> </td><td> </td><td> </td><td> </td><td> </td><td> </td><td> </td></tr><tr><td> </td><td> </td><td> </td><td> </td><td> </td><td> </td><td> </td><td> </td><td> </td><td> </td><td> </td><td> </td><td> </td><td> </td><td> </td><td> </td><td> </td><td> </td><td> </td><td> </td></tr></table>																																																													<table border="1"><tr><td> </td><td> </td><td> </td><td> </td><td> </td><td> </td><td> </td><td> </td><td> </td><td> </td><td> </td><td> </td><td> </td><td> </td><td> </td><td> </td><td> </td><td> </td><td> </td><td> </td></tr><tr><td> </td><td> </td><td> </td><td> </td><td> </td><td> </td><td> </td><td> </td><td> </td><td> </td><td> </td><td> </td><td> </td><td> </td><td> </td><td> </td><td> </td><td> </td><td> </td><td> </td></tr><tr><td> </td><td> </td><td> </td><td> </td><td> </td><td> </td><td> </td><td> </td><td> </td><td> </td><td> </td><td> </td><td> </td><td> </td><td> </td><td> </td><td> </td><td> </td><td> </td><td> </td></tr></table>																																																													<table border="1"><tr><td> </td><td> </td><td> </td><td> </td><td> </td><td> </td><td> </td><td> </td><td> </td><td> </td><td> </td><td> </td><td> </td><td> </td><td> </td><td> </td><td> </td><td> </td><td> </td><td> </td></tr><tr><td> </td><td> </td><td> </td><td> </td><td> </td><td> </td><td> </td><td> </td><td> </td><td> </td><td> </td><td> </td><td> </td><td> </td><td> </td><td> </td><td> </td><td> </td><td> </td><td> </td></tr><tr><td> </td><td> </td><td> </td><td> </td><td> </td><td> </td><td> </td><td> </td><td> </td><td> </td><td> </td><td> </td><td> </td><td> </td><td> </td><td> </td><td> </td><td> </td><td> </td><td> </td></tr></table>																																																													<table border="1"><tr><td> </td><td> </td><td> </td><td> </td><td> </td><td> </td><td> </td><td> </td><td> </td><td> </td><td> </td><td> </td><td> </td><td> </td><td> </td><td> </td><td> </td><td> </td><td> </td><td> </td></tr><tr><td> </td><td> </td><td> </td><td> </td><td> </td><td> </td><td> </td><td> </td><td> </td><td> </td><td> </td><td> </td><td> </td><td> </td><td> </td><td> </td><td> </td><td> </td><td> </td><td> </td></tr><tr><td> </td><td> </td><td> </td><td> </td><td> </td><td> </td><td> </td><td> </td><td> </td><td> </td><td> </td><td> </td><td> </td><td> </td><td> </td><td> </td><td> </td><td> </td><td> </td><td> </td></tr></table>																																																													<table border="1"><tr><td> </td><td> </td><td> </td><td> </td><td> </td><td> </td><td> </td><td> </td><td> </td><td> </td><td> </td><td> </td><td> </td><td> </td><td> </td><td> </td><td> </td><td> </td><td> </td><td> </td></tr><tr><td> </td><td> </td><td> </td><td> </td><td> </td><td> </td><td> </td><td> </td><td> </td><td> </td><td> </td><td> </td><td> </td><td> </td><td> </td><td> </td><td> </td><td> </td><td> </td><td> </td></tr><tr><td> </td><td> </td><td> </td><td> </td><td> </td><td> </td><td> </td><td> </td><td> </td><td> </td><td> </td><td> </td><td> </td><td> </td><td> </td><td> </td><td> </td><td> </td><td> </td><td> </td></tr></table>																																																												
<table border="1"><tr><td> </td><td> </td><td> </td><td> </td><td> </td><td> </td><td> </td><td> </td><td> </td><td> </td><td> </td><td> </td><td> </td><td> </td><td> </td><td> </td><td> </td><td> </td><td> </td><td> </td></tr><tr><td> </td><td> </td><td> </td><td> </td><td> </td><td> </td><td> </td><td> </td><td> </td><td> </td><td> </td><td> </td><td> </td><td> </td><td> </td><td> </td><td> </td><td> </td><td> </td><td> </td></tr><tr><td> </td><td> </td><td> </td><td> </td><td> </td><td> </td><td> </td><td> </td><td> </td><td> </td><td> </td><td> </td><td> </td><td> </td><td> </td><td> </td><td> </td><td> </td><td> </td><td> </td></tr></table>																																																													<table border="1"><tr><td> </td><td> </td><td> </td><td> </td><td> </td><td> </td><td> </td><td> </td><td> </td><td> </td><td> </td><td> </td><td> </td><td> </td><td> </td><td> </td><td> </td><td> </td><td> </td><td> </td></tr><tr><td> </td><td> </td><td> </td><td> </td><td> </td><td> </td><td> </td><td> </td><td> </td><td> </td><td> </td><td> </td><td> </td><td> </td><td> </td><td> </td><td> </td><td> </td><td> </td><td> </td></tr><tr><td> </td><td> </td><td> </td><td> </td><td> </td><td> </td><td> </td><td> </td><td> </td><td> </td><td> </td><td> </td><td> </td><td> </td><td> </td><td> </td><td> </td><td> </td><td> </td><td> </td></tr></table>																																																													<table border="1"><tr><td> </td><td> </td><td> </td><td> </td><td> </td><td> </td><td> </td><td> </td><td> </td><td> </td><td> </td><td> </td><td> </td><td> </td><td> </td><td> </td><td> </td><td> </td><td> </td><td> </td></tr><tr><td> </td><td> </td><td> </td><td> </td><td> </td><td> </td><td> </td><td> </td><td> </td><td> </td><td> </td><td> </td><td> </td><td> </td><td> </td><td> </td><td> </td><td> </td><td> </td><td> </td></tr><tr><td> </td><td> </td><td> </td><td> </td><td> </td><td> </td><td> </td><td> </td><td> </td><td> </td><td> </td><td> </td><td> </td><td> </td><td> </td><td> </td><td> </td><td> </td><td> </td><td> </td></tr></table>																																																													<table border="1"><tr><td> </td><td> </td><td> </td><td> </td><td> </td><td> </td><td> </td><td> </td><td> </td><td> </td><td> </td><td> </td><td> </td><td> </td><td> </td><td> </td><td> </td><td> </td><td> </td><td> </td></tr><tr><td> </td><td> </td><td> </td><td> </td><td> </td><td> </td><td> </td><td> </td><td> </td><td> </td><td> </td><td> </td><td> </td><td> </td><td> </td><td> </td><td> </td><td> </td><td> </td><td> </td></tr><tr><td> </td><td> </td><td> </td><td> </td><td> </td><td> </td><td> </td><td> </td><td> </td><td> </td><td> </td><td> </td><td> </td><td> </td><td> </td><td> </td><td> </td><td> </td><td> </td><td> </td></tr></table>																																																													<table border="1"><tr><td> </td><td> </td><td> </td><td> </td><td> </td><td> </td><td> </td><td> </td><td> </td><td> </td><td> </td><td> </td><td> </td><td> </td><td> </td><td> </td><td> </td><td> </td><td> </td><td> </td></tr><tr><td> </td><td> </td><td> </td><td> </td><td> </td><td> </td><td> </td><td> </td><td> </td><td> </td><td> </td><td> </td><td> </td><td> </td><td> </td><td> </td><td> </td><td> </td><td> </td><td> </td></tr><tr><td> </td><td> </td><td> </td><td> </td><td> </td><td> </td><td> </td><td> </td><td> </td><td> </td><td> </td><td> </td><td> </td><td> </td><td> </td><td> </td><td> </td><td> </td><td> </td><td> </td></tr></table>																																																												
<table border="1"><tr><td> </td><td> </td><td> </td><td> </td><td> </td><td> </td><td> </td><td> </td><td> </td><td> </td><td> </td><td> </td><td> </td><td> </td><td> </td><td> </td><td> </td><td> </td><td> </td><td> </td></tr><tr><td> </td><td> </td><td> </td><td> </td><td> </td><td> </td><td> </td><td> </td><td> </td><td> </td><td> </td><td> </td><td> </td><td> </td><td> </td><td> </td><td> </td><td> </td><td> </td><td> </td></tr><tr><td> </td><td> </td><td> </td><td> </td><td> </td><td> </td><td> </td><td> </td><td> </td><td> </td><td> </td><td> </td><td> </td><td> </td><td> </td><td> </td><td> </td><td> </td><td> </td><td> </td></tr></table>																																																													<table border="1"><tr><td> </td><td> </td><td> </td><td> </td><td> </td><td> </td><td> </td><td> </td><td> </td><td> </td><td> </td><td> </td><td> </td><td> </td><td> </td><td> </td><td> </td><td> </td><td> </td><td> </td></tr><tr><td> </td><td> </td><td> </td><td> </td><td> </td><td> </td><td> </td><td> </td><td> </td><td> </td><td> </td><td> </td><td> </td><td> </td><td> </td><td> </td><td> </td><td> </td><td> </td><td> </td></tr><tr><td> </td><td> </td><td> </td><td> </td><td> </td><td> </td><td> </td><td> </td><td> </td><td> </td><td> </td><td> </td><td> </td><td> </td><td> </td><td> </td><td> </td><td> </td><td> </td><td> </td></tr></table>																																																													<table border="1"><tr><td> </td><td> </td><td> </td><td> </td><td> </td><td> </td><td> </td><td> </td><td> </td><td> </td><td> </td><td> </td><td> </td><td> </td><td> </td><td> </td><td> </td><td> </td><td> </td><td> </td></tr><tr><td> </td><td> </td><td> </td><td> </td><td> </td><td> </td><td> </td><td> </td><td> </td><td> </td><td> </td><td> </td><td> </td><td> </td><td> </td><td> </td><td> </td><td> </td><td> </td><td> </td></tr><tr><td> </td><td> </td><td> </td><td> </td><td> </td><td> </td><td> </td><td> </td><td> </td><td> </td><td> </td><td> </td><td> </td><td> </td><td> </td><td> </td><td> </td><td> </td><td> </td><td> </td></tr></table>																																																													<table border="1"><tr><td> </td><td> </td><td> </td><td> </td><td> </td><td> </td><td> </td><td> </td><td> </td><td> </td><td> </td><td> </td><td> </td><td> </td><td> </td><td> </td><td> </td><td> </td><td> </td><td> </td></tr><tr><td> </td><td> </td><td> </td><td> </td><td> </td><td> </td><td> </td><td> </td><td> </td><td> </td><td> </td><td> </td><td> </td><td> </td><td> </td><td> </td><td> </td><td> </td><td> </td><td> </td></tr><tr><td> </td><td> </td><td> </td><td> </td><td> </td><td> </td><td> </td><td> </td><td> </td><td> </td><td> </td><td> </td><td> </td><td> </td><td> </td><td> </td><td> </td><td> </td><td> </td><td> </td></tr></table>																																																													<table border="1"><tr><td> </td><td> </td><td> </td><td> </td><td> </td><td> </td><td> </td><td> </td><td> </td><td> </td><td> </td><td> </td><td> </td><td> </td><td> </td><td> </td><td> </td><td> </td><td> </td><td> </td></tr><tr><td> </td><td> </td><td> </td><td> </td><td> </td><td> </td><td> </td><td> </td><td> </td><td> </td><td> </td><td> </td><td> </td><td> </td><td> </td><td> </td><td> </td><td> </td><td> </td><td> </td></tr><tr><td> </td><td> </td><td> </td><td> </td><td> </td><td> </td><td> </td><td> </td><td> </td><td> </td><td> </td><td> </td><td> </td><td> </td><td> </td><td> </td><td> </td><td> </td><td> </td><td> </td></tr></table>																																																												
<table border="1"><tr><td> </td><td> </td><td> </td><td> </td><td> </td><td> </td><td> </td><td> </td><td> </td><td> </td><td> </td><td> </td><td> </td><td> </td><td> </td><td> </td><td> </td><td> </td><td> </td><td> </td></tr><tr><td> </td><td> </td><td> </td><td> </td><td> </td><td> </td><td> </td><td> </td><td> </td><td> </td><td> </td><td> </td><td> </td><td> </td><td> </td><td> </td><td> </td><td> </td><td> </td><td> </td></tr><tr><td> </td><td> </td><td> </td><td> </td><td> </td><td> </td><td> </td><td> </td><td> </td><td> </td><td> </td><td> </td><td> </td><td> </td><td> </td><td> </td><td> </td><td> </td><td> </td><td> </td></tr></table>																																																													<table border="1"><tr><td> </td><td> </td><td> </td><td> </td><td> </td><td> </td><td> </td><td> </td><td> </td><td> </td><td> </td><td> </td><td> </td><td> </td><td> </td><td> </td><td> </td><td> </td><td> </td><td> </td></tr><tr><td> </td><td> </td><td> </td><td> </td><td> </td><td> </td><td> </td><td> </td><td> </td><td> </td><td> </td><td> </td><td> </td><td> </td><td> </td><td> </td><td> </td><td> </td><td> </td><td> </td></tr><tr><td> </td><td> </td><td> </td><td> </td><td> </td><td> </td><td> </td><td> </td><td> </td><td> </td><td> </td><td> </td><td> </td><td> </td><td> </td><td> </td><td> </td><td> </td><td> </td><td> </td></tr></table>																																																													<table border="1"><tr><td> </td><td> </td><td> </td><td> </td><td> </td><td> </td><td> </td><td> </td><td> </td><td> </td><td> </td><td> </td><td> </td><td> </td><td> </td><td> </td><td> </td><td> </td><td> </td><td> </td></tr><tr><td> </td><td> </td><td> </td><td> </td><td> </td><td> </td><td> </td><td> </td><td> </td><td> </td><td> </td><td> </td><td> </td><td> </td><td> </td><td> </td><td> </td><td> </td><td> </td><td> </td></tr><tr><td> </td><td> </td><td> </td><td> </td><td> </td><td> </td><td> </td><td> </td><td> </td><td> </td><td> </td><td> </td><td> </td><td> </td><td> </td><td> </td><td> </td><td> </td><td> </td><td> </td></tr></table>																																																													<table border="1"><tr><td> </td><td> </td><td> </td><td> </td><td> </td><td> </td><td> </td><td> </td><td> </td><td> </td><td> </td><td> </td><td> </td><td> </td><td> </td><td> </td><td> </td><td> </td><td> </td><td> </td></tr><tr><td> </td><td> </td><td> </td><td> </td><td> </td><td> </td><td> </td><td> </td><td> </td><td> </td><td> </td><td> </td><td> </td><td> </td><td> </td><td> </td><td> </td><td> </td><td> </td><td> </td></tr><tr><td> </td><td> </td><td> </td><td> </td><td> </td><td> </td><td> </td><td> </td><td> </td><td> </td><td> </td><td> </td><td> </td><td> </td><td> </td><td> </td><td> </td><td> </td><td> </td><td> </td></tr></table>																																																													<table border="1"><tr><td> </td><td> </td><td> </td><td> </td><td> </td><td> </td><td> </td><td> </td><td> </td><td> </td><td> </td><td> </td><td> </td><td> </td><td> </td><td> </td><td> </td><td> </td><td> </td><td> </td></tr><tr><td> </td><td> </td><td> </td><td> </td><td> </td><td> </td><td> </td><td> </td><td> </td><td> </td><td> </td><td> </td><td> </td><td> </td><td> </td><td> </td><td> </td><td> </td><td> </td><td> </td></tr><tr><td> </td><td> </td><td> </td><td> </td><td> </td><td> </td><td> </td><td> </td><td> </td><td> </td><td> </td><td> </td><td> </td><td> </td><td> </td><td> </td><td> </td><td> </td><td> </td><td> </td></tr></table>																																																												
<table border="1"><tr><td> </td><td> </td><td> </td><td> </td><td> </td><td> </td><td> </td><td> </td><td> </td><td> </td><td> </td><td> </td><td> </td><td> </td><td> </td><td> </td><td> </td><td> </td><td> </td><td> </td></tr><tr><td> </td><td> </td><td> </td><td> </td><td> </td><td> </td><td> </td><td> </td><td> </td><td> </td><td> </td><td> </td><td> </td><td> </td><td> </td><td> </td><td> </td><td> </td><td> </td><td> </td></tr><tr><td> </td><td> </td><td> </td><td> </td><td> </td><td> </td><td> </td><td> </td><td> </td><td> </td><td> </td><td> </td><td> </td><td> </td><td> </td><td> </td><td> </td><td> </td><td> </td><td> </td></tr></table>																																																													<table border="1"><tr><td> </td><td> </td><td> </td><td> </td><td> </td><td> </td><td> </td><td> </td><td> </td><td> </td><td> </td><td> </td><td> </td><td> </td><td> </td><td> </td><td> </td><td> </td><td> </td><td> </td></tr><tr><td> </td><td> </td><td> </td><td> </td><td> </td><td> </td><td> </td><td> </td><td> </td><td> </td><td> </td><td> </td><td> </td><td> </td><td> </td><td> </td><td> </td><td> </td><td> </td><td> </td></tr><tr><td> </td><td> </td><td> </td><td> </td><td> </td><td> </td><td> </td><td> </td><td> </td><td> </td><td> </td><td> </td><td> </td><td> </td><td> </td><td> </td><td> </td><td> </td><td> </td><td> </td></tr></table>																																																													<table border="1"><tr><td> </td><td> </td><td> </td><td> </td><td> </td><td> </td><td> </td><td> </td><td> </td><td> </td><td> </td><td> </td><td> </td><td> </td><td> </td><td> </td><td> </td><td> </td><td> </td><td> </td></tr><tr><td> </td><td> </td><td> </td><td> </td><td> </td><td> </td><td> </td><td> </td><td> </td><td> </td><td> </td><td> </td><td> </td><td> </td><td> </td><td> </td><td> </td><td> </td><td> </td><td> </td></tr><tr><td> </td><td> </td><td> </td><td> </td><td> </td><td> </td><td> </td><td> </td><td> </td><td> </td><td> </td><td> </td><td> </td><td> </td><td> </td><td> </td><td> </td><td> </td><td> </td><td> </td></tr></table>																																																													<table border="1"><tr><td> </td><td> </td><td> </td><td> </td><td> </td><td> </td><td> </td><td> </td><td> </td><td> </td><td> </td><td> </td><td> </td><td> </td><td> </td><td> </td><td> </td><td> </td><td> </td><td> </td></tr><tr><td> </td><td> </td><td> </td><td> </td><td> </td><td> </td><td> </td><td> </td><td> </td><td> </td><td> </td><td> </td><td> </td><td> </td><td> </td><td> </td><td> </td><td> </td><td> </td><td> </td></tr><tr><td> </td><td> </td><td> </td><td> </td><td> </td><td> </td><td> </td><td> </td><td> </td><td> </td><td> </td><td> </td><td> </td><td> </td><td> </td><td> </td><td> </td><td> </td><td> </td><td> </td></tr></table>																																																													<table border="1"><tr><td> </td><td> </td><td> </td><td> </td><td> </td><td> </td><td> </td><td> </td><td> </td><td> </td><td> </td><td> </td><td> </td><td> </td><td> </td><td> </td><td> </td><td> </td><td> </td><td> </td></tr><tr><td> </td><td> </td><td> </td><td> </td><td> </td><td> </td><td> </td><td> </td><td> </td><td> </td><td> </td><td> </td><td> </td><td> </td><td> </td><td> </td><td> </td><td> </td><td> </td><td> </td></tr><tr><td> </td><td> </td><td> </td><td> </td><td> </td><td> </td><td> </td><td> </td><td> </td><td> </td><td> </td><td> </td><td> </td><td> </td><td> </td><td> </td><td> </td><td> </td><td> </td><td> </td></tr></table>																																																												

You are solely responsible for spelling and text breaks. A signed copy of this form must be returned electronically or via fax before your order can be processed.

Date _____

Signature _____