

MS-RA55 Installation Instructions

Important Safety Information

⚠ WARNING

Failure to follow these warnings and cautions could result in personal injury, damage to the vessel, or poor product performance.

See the *Important Safety and Product Information* guide in the product box for product warnings and other important information.

This device must be installed according to these instructions.

Disconnect the vessel's power supply before beginning to install this product.

Before applying power to this product, make sure it has been correctly grounded, following the instructions in the guide.

⚠ CAUTION

Always wear safety goggles, ear protection, and a dust mask when drilling, cutting, or sanding.

NOTICE

When drilling or cutting, always check what is on the opposite side of the surface.

You must read all installation instructions before beginning the installation. If you experience difficulty during the installation, contact FUSION Product Support.

What's In the Box

- Mounting gasket
- Four 6-gauge, self-tapping screws
- Power and speaker wiring harness
- Two screw covers

Tools Needed

- Phillips screwdriver
- Electric drill
- Drill bit (size varies based on surface material and screws used)
- Rotary cutting tool or jigsaw
- Marine sealant (optional)

Mounting Considerations

- The stereo must be mounted on a flat surface.
- The stereo must be mounted in a location that allows open airflow around the rear of the stereo for heat ventilation.
- If you are installing the stereo in a location that may be exposed to water, it must be mounted within 45 degrees of the horizontal plane.

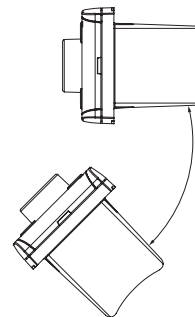

- If you are installing the stereo in a location that may be exposed to water, the cable should have a drip loop to allow water to drip down off the cable and avoid damage to the stereo.
- If you need to mount the stereo outside a boat, it must be mounted in a location far above the waterline, where it is not submerged.
- If you need to mount the stereo outside a boat, it should be mounted in a location where it cannot be damaged by docks, pilings, or other pieces of equipment.
- To avoid interference with a magnetic compass, the stereo should be installed at least 15 cm (5.9 in.) away from a compass.

Mounting the Stereo

NOTICE

Be careful when cutting the hole to mount the stereo. There is only a small amount of clearance between the case and the mounting holes, and cutting the hole too large could compromise the stability of the stereo after it is mounted.

Be careful when installing the stereo in an aluminum boat or a boat with a conductive hull, if you require the electrical system to be isolated from the boat hull.

Do not apply grease or lubricant to the screws when fastening the stereo to the mounting surface. Grease or other lubricants can cause damage to the stereo housing.

Before you can mount the stereo in a new location on the mounting surface, you must select a location in accordance with the mounting considerations.

- 1 Trim the template and make sure it fits at the mounting location.
- 2 Adhere the template to the mounting surface.
- 3 Using a drill bit appropriate for the mounting surface, drill a hole inside the corner of the dashed line on the template to prepare the mounting surface for cutting.
- 4 Using a rotary-cutting tool, cut the mounting surface along the inside of the dashed line on the template.
- 5 Place the stereo in the cutout to test the fit.
- 6 If necessary, use a file and sandpaper to refine the size of the cutout.
- 7 After the stereo fits correctly in the cutout, ensure the mounting holes on the stereo line up with the pilot holes on the template.
- 8 If the mounting holes on the stereo do not line up, mark the new pilot-hole locations.
- 9 Using an appropriately sized drill bit for the mounting surface and screw type, drill the pilot holes.
- 10 Remove the template from the mounting surface.
- 11 Make the necessary wiring connections ([Connections, page 2](#)).
- 12 Place the mounting gasket on the back of the stereo ①.

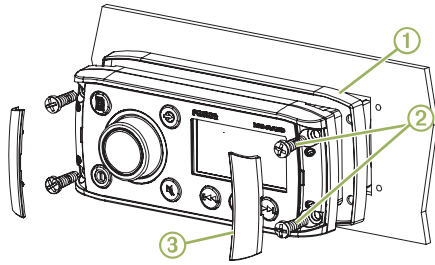

13 Place the stereo in the cutout.

14 Secure the stereo to the mounting surface using the included screws ②.

15 Snap the screw covers in place ③.

Connections

The stereo must be connected to power, to speakers, and to media input sources to function correctly. You should carefully plan the layout of the stereo, speakers, and your input sources before making any connections.

Wiring Harness Wire and Connector Identification

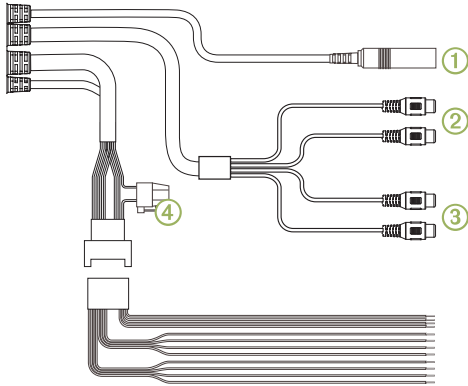

Wire Function	Wire Color/ Number	Notes
Antenna	①	Connects the stereo to a typical AM/FM antenna using an RF coaxial connector. If you are installing the stereo on a boat with a metal hull, you must use a ground-dependent antenna, and if you are installing the stereo on a boat with a non-metal hull, you must use a ground-independent antenna. See the installation instructions provided with your antenna for more information.
Auxiliary in left Auxiliary in right	②	Provides a red and white RCA stereo line input for audio sources, such as a CD or MP3 player.
Zone 1 line out (left) Zone 1 line out (right)	③	Provides a full-range output to an external amplifier, and is associated with the volume and tone for zone 1.
Power (+)	Red (yellow on some wire harnesses)	Connects to the positive terminal of a 12 Vdc power source capable of supplying 10 A.
Ground (-)	Black	Connects to the negative terminal of a 12 Vdc power source. This wire should be connected before connecting the yellow wire. All accessories connected to the stereo must share a common ground location.

Wire Function	Wire Color/ Number	Notes
Amplifier on	Blue	Connects to an optional external amplifier to turn it on when the stereo turns on.
Dim	Orange	Connects to the boat's illumination wire to dim the stereo screen when the lights are on. The gauge of the illumination wire must be suitable for the fuse supplying the circuit it is connected to.
Speaker zone 1 left (+)	White	
Speaker zone 1 left (-)	White/black	
Speaker zone 1 right (+)	Gray	
Speaker zone 1 right (-)	Gray/black	
Speaker zone 2 left (+)	Green	
Speaker zone 2 left (-)	Green/black	
Speaker zone 2 right (+)	Purple	
Speaker zone 2 right (-)	Purple/black	
Fuse	④	Contains the 10 A fuse.

Connecting to Power

When connecting the stereo to power, you should connect it through the ignition or another manual switch.

If it is necessary to extend the power and ground wires, use 14 AWG (2.08 mm²) wire. For extensions longer than 1 m (3 ft.), use 12 AWG (3.31 mm²) wire.

- 1 Route the power wire ① to the ignition or another manual switch ②, and route the black ground wire ③ to the battery.

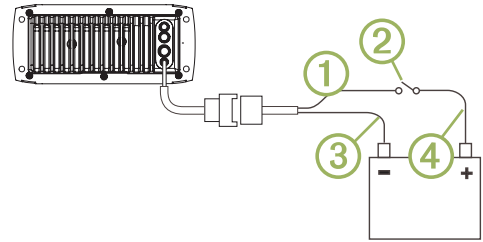

- 2 If necessary, route a wire ④ between the switch and the battery .
- 3 Route the wiring-harness plug to the stereo.
Do not connect the wiring harness to the stereo until after all of the bare wire connections have been made.
- 4 Connect the black wire to the negative (-) battery terminal.
- 5 Connect the power wire to the ignition or another manual switch, and connect the switch to the positive (+) battery terminal if necessary.
- 6 Connect the wiring harness plug to the stereo.

Single-Zone System Wiring Example

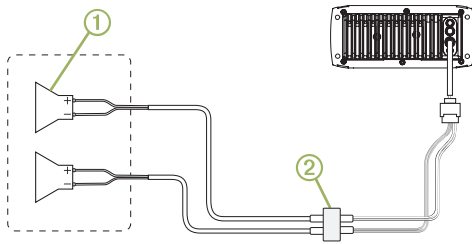

①	Speakers
②	Water-tight connection

Complete System Wiring

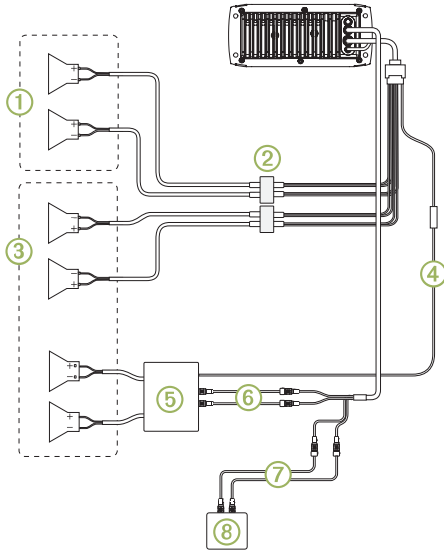

Item	Description
①	Zone 2 speakers
②	Water-tight connection
③	Zone 1 speakers
④	Amplifier-on signal wire
⑤	Powered amplifier
⑥	Zone 1 line out
⑦	Line in cable
⑧	Auxiliary line in device

Stereo Information

Specifications

General	
Weight	556 g (19.6 oz.)
Water resistance	IEC 60529 IPX5
Operating temperature range	From 0 to 50°C (from 32 to 122°F)
Storage temperature range	From -20 to 70°C (from -4 to 158°F)
Input voltage	From 10.8 to 16 Vdc
Fuse	10 A
Current (max.)	10 A
Current (muted)	Less than 350 mA
Current (standby)	Less than 5 mA
Compass-safe distance	15 cm (5.9 in.)

On-board, Class AB Amplifier

Output music power per channel	45 W max. x 4 channels at 4 Ohms per channel
Total output music power	180 W max.

Tuner	Europe and Australasia	USA	Japan
FM radio frequency range	87.5 to 108 MHz	87.5 to 107.9 MHz	76 to 95 MHz
FM frequency step	50 kHz	200 kHz	50 kHz
AM radio frequency range	522 to 1620 kHz	530 to 1710 kHz	522 to 1620 kHz
AM frequency step	9 kHz	10 kHz	9 kHz

Stereo Dimension Drawings

Front Dimensions

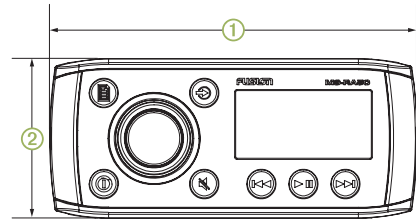

①	160 mm (6.3 in.)
②	71.5 mm (2.8 in.)

Side Dimensions

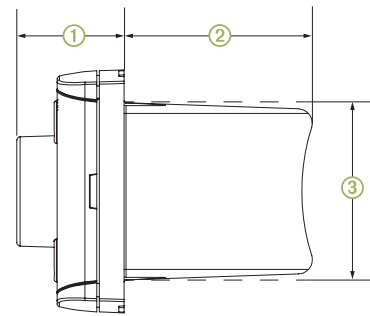

①	32 mm (1.25 in.)
②	52 mm (2 in.)
③	50 mm (2 in.)

Top Dimensions

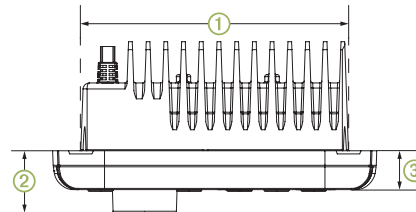

①	130 mm (5.1 in.)
②	32 mm (1.25 in.)
③	20 mm (0.8 in.)

Reducing Unexpected Noise

If the stereo is subject to strong electrical interference, this interference might be heard through the speakers. You should take appropriate action to suppress or reduce the noise.

- Add clip-on ferrite beads to the cables connected directly to the product.
- Add clip-on ferrite beads to the device in the vessel that is causing the interference.
- Disconnect the AUX input cable from the RCA connector when it is not used.

- For additional information, go to www.fusionentertainment.com and contact Tech Support.

Cleaning the Device

- 1** Dampen a soft, clean, lint-free cloth with fresh water.
- 2** Gently wipe the device.

Registering Your FUSION MS-RA55

Help us better support you by completing our online registration today.

- Go to www.fusionentertainment.com.
- Keep the original sales receipt, or a photocopy, in a safe place.

© 2016–2018 Garmin Ltd. or its subsidiaries

Garmin®, the Garmin logo, FUSION®, and the Fusion logo are trademarks of Garmin Ltd. or its subsidiaries, registered in the USA and other countries. These trademarks may not be used without the express permission of Garmin.

Bluetooth® word mark and logos are owned by the Bluetooth SIG, Inc. and any use of such marks by Garmin is under license. Other trademarks and trade names are those of their respective owners.

