



## INSTRUCTION MANUAL

# VHF MARINE TRANSCEIVER IC-M510



This device complies with Part 15 of the FCC Rules. Operation is subject to the condition that this device does not cause harmful interference.

Icom Inc.

Thank you for choosing this Icom product.

This product was designed and built with Icom's state of the art technology and craftsmanship. With proper care, this product should provide you with years of trouble-free operation.

## ■ Important

**READ ALL INSTRUCTIONS** carefully and completely before using the transceiver.

**SAVE THIS INSTRUCTION MANUAL** — This instruction manual contains important operating instructions for the IC-M510.

This instruction manual includes some functions that are usable only when they are preset by your dealer.

Ask your dealer for details.

## ■ Explicit Definitions

WORD	DEFINITION
<b>⚠ WARNING!</b>	Personal injury, fire hazard or electric shock may occur.
<b>CAUTION</b>	Equipment damage may occur.
<b>NOTE</b>	If disregarded, inconvenience only. No risk of personal injury, fire or electric shock.

Icom is not responsible for the destruction, damage to, or performance of any Icom or non-Icom equipment, if the malfunction is because of:

- Force majeure, including, but not limited to, fires, earthquakes, storms, floods, lightning, other natural disasters, disturbances, riots, war, or radioactive contamination.
- The use of Icom transceivers with any equipment that is not manufactured or approved by Icom.

## ■ Features

- Fixed mount Class D DSC marine VHF Transceiver
- Integrated Wireless LAN for connection with RS-M500 and CT-M500.
- AIS information display\*.  
\*An external AIS receiver or an external NMEA sentence is required
- New Sleek Design
- Wide (nearly 180 degree) viewing angle color TFT LCD with night mode.
- Simplified navigation function.
- Clear, Loud Audio
- White light backlit keys for increased visibility in low-light and dark conditions.
- Integrated GPS receiver.

Icom, Icom Inc. and the Icom logo are registered trademarks of Icom Incorporated (Japan) in Japan, the United States, the United Kingdom, Germany, France, Spain, Russia, Australia, New Zealand, and/or other countries.

AquaQuake is a trademark of Icom Incorporated.

COMMANDMIC is a trademark of Icom Incorporated.

NMEA 2000 is a trademark of the National Maritime Electronics Association, Inc.

Android is a trademark of Google, LLC.

IOS is a trademark or registered trademark of Cisco in the U.S. and other countries and is used under license.

All other products or brands are registered trademarks or trademarks of their respective holders.

---

## ■ In Case of Emergency

If your vessel requires assistance, contact other vessels and the Coast Guard by sending a distress call on Channel 16 or transmit your Distress call using Digital Selective Calling (DSC) on Channel 70.

### ◇ Using Channel 16

1. Push [16/C] to switch to Channel 16.
2. While holding down [PTT], give the appropriate information as follows:

- “**MAYDAY MAYDAY MAYDAY.**”
- “**THIS IS** [ ]” (name of vessel).
- Say your call sign or other indication of the vessel (AND your 9 digit DSC ID, if you have one).
- “**LOCATED AT** [ ]” (your position).
- State the nature of the distress and assistance required.
- Give any other information which might facilitate the rescue.

### ◇ Using Digital Selective Calling

1. Lift up the key cover, hold down [DISTRESS] for 3 seconds until the 3 short beeps and then one long beep sound.

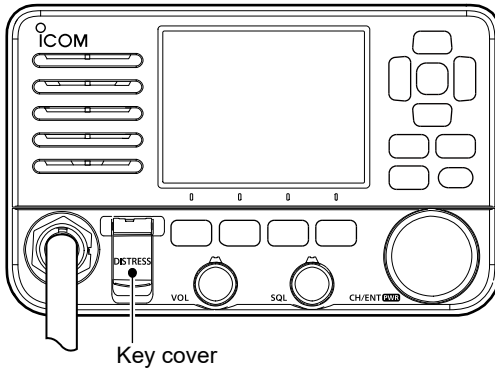

2. Wait for an acknowledgment from another station.
3. After the acknowledgment is received, Channel 16 is automatically selected.
4. Hold down [PTT], then transmit the appropriate information as listed above.

---

## ■ Radio Operation Warning



**WARNING**

Icom requires the radio operator to meet the FCC Requirements for Radio Frequency Exposure. An omnidirectional antenna with gain not greater than 9 dBi must be mounted a minimum of 5 meters (measured from the lowest point of the antenna) vertically above the main deck and all possible personnel. This is the minimum safe separation distance estimated to meet all RF exposure compliance requirements. This 5 meter distance is based on the FCC Safe Maximum Permissible Exposure (MPE) distance of 3 meters added to the height of an adult (2 meters) and is appropriate for all vessels.

For watercraft without suitable structures, the antenna must be mounted so as to maintain a minimum of 1 meter vertically between the antenna, (measured from the lowest point of the antenna), to the heads of all persons AND all persons must stay outside of the 3 meter MPE radius.

Do not transmit with radio and antenna when persons are within the MPE radius of the antenna, unless such persons (such as driver or radio operator) are shielded from antenna field by a grounded metallic barrier. The MPE Radius is the minimum distance from the antenna axis that person should maintain in order to avoid RF exposure higher than the allowable MPE level set by FCC.

**FAILURE TO OBSERVE THESE LIMITS MAY ALLOW THOSE WITHIN THE MPE RADIUS TO EXPERIENCE RF RADIATION ABSORPTION WHICH EXCEEDS THE FCC MAXIMUM PERMISSIBLE EXPOSURE (MPE) LIMIT.**

**IT IS THE RESPONSIBILITY OF THE RADIO OPERATOR TO ENSURE THAT THE MAXIMUM PERMISSIBLE EXPOSURE LIMITS ARE OBSERVED AT ALL TIMES DURING RADIO TRANSMISSION. THE RADIO OPERATOR IS TO ENSURE THAT NO BYSTANDERS COME WITHIN THE RADIUS OF THE MAXIMUM PERMISSIBLE EXPOSURE LIMITS.**

### **Determining MPE Radius**

**THE MAXIMUM PERMISSIBLE EXPOSURE (MPE) RADIUS HAS BEEN ESTIMATED TO BE A RADIUS OF ABOUT 3 M PER OET BULLETIN 65 OF THE FCC. THIS ESTIMATE IS MADE ASSUMING THE MAXIMUM POWER OF THE RADIO AND ANTENNAS WITH A MAXIMUM GAIN OF 9 dBi ARE USED FOR A SHIP MOUNTED SYSTEM.**

### **IC-M510 and CT-M500 RF Safety warning**

An internal Wireless LAN module and an antenna are supplied with the IC-M510 and CT-M500.

To comply with FCC/ISED RF Exposure for the installed Wireless LAN unit, the device should be installed and operated with a minimum distance of 20 cm between the device and all persons. No other transmitting antenna is permitted to be located within 20 cm of the device.



---

## ■ Avertissement Pour Les Opérateurs Radio



AVERTISSEMENT

Icom exige que l'opérateur radio se conforme aux exigences de la FCC en matière d'exposition aux radiofréquences. Une antenne omnidirectionnelle dont le gain ne dépasse pas 9 dBi doit être fixée à une distance minimale de 5 mètres (mesurée depuis le point le plus bas de l'antenne) verticalement au-dessus du pont principal et de tout le personnel qui peut s'y trouver. Il s'agit de la distance de sécurité minimale prévue pour satisfaire aux exigences de conformité en matière d'exposition aux RF. Cette distance de 5 mètres est établie en fonction de l'exposition maximale admissible sécuritaire de 3 mètres établie par la FCC, à laquelle on ajoute la hauteur d'un adulte (2 mètres); cette distance convient pour tous les navires.

Dans le cas des embarcations sans structure convenable, l'antenne doit être fixée de façon à maintenir une distance minimale de 1 mètre verticalement entre cette antenne (mesurée depuis son point le plus bas) et la tête de toute personne présente; toutes les personnes présentes doivent se tenir à l'extérieur d'un rayon d'exposition maximale admissible de 3 mètres.

Ne pas émettre à l'aide de la radio et de l'antenne lorsque des personnes se trouvent à l'intérieur du rayon d'exposition maximale admissible de cette antenne, à moins que ces personnes (comme le conducteur ou l'opérateur radio) ne soient protégées du champ de l'antenne par un écran métallique relié à la masse. Le rayon d'exposition maximale admissible équivaut à la distance minimale que cette personne doit maintenir entre elle et l'axe de l'antenne pour éviter une exposition aux RF supérieure au niveau d'exposition maximale admissible fixé par la FCC.

**LE NON-RESPECT DE CES LIMITES PEUT CAUSER, POUR LES PERSONNES SITUÉES DANS LE RAYON D'EXPOSITION MAXIMALE ADMISSIBLE, UNE ABSORPTION DE RAYONNEMENT DE RF SUPÉRIEURE À L'EXPOSITION MAXIMALE ADMISSIBLE FIXÉE PAR LA FCC.**

**L'OPÉRATEUR RADIO EST RESPONSABLE D'ASSURER QUE LES LIMITES D'EXPOSITION MAXIMALE ADMISSIBLE SOIENT RESPECTÉES EN TOUT TEMPS PENDANT LA TRANSMISSION RADIO. L'OPÉRATEUR RADIO DOIT S'ASSURER QU'AUCUNE PERSONNE PRÉSENTE NE SE SITUE À L'INTÉRIEUR DU RAYON D'EXPOSITION MAXIMALE ADMISSIBLE.**

**Établir le rayon d'exposition maximale admissible**

**ON ESTIME QUE LE RAYON D'EXPOSITION MAXIMALE ADMISSIBLE EST D'ENVIRON 3 M, TEL QUE STIPULÉ DANS LE BULLETIN OET 65 DE LA FCC. CETTE DISTANCE ESTIMÉE TIEN COMPTE D'UN SYSTÈME INSTALLÉ SUR UN NAVIRE UTILISANT LA PUISSANCE MAXIMALE DE LA RADIO ET DES ANTENNES DONT LE GAIN MAXIMAL EST DE 9 dBi.**

### **Avertissement de sécurité RF IC-M510 et CT-M500**

Un module LAN sans fil interne et une antenne sont fournis avec l'IC-M510 et le CT-M500. Pour se conformer à l'exposition aux RF FCC / ISED pour l'unité LAN sans fil installée, l'appareil doit être installé et utilisé à une distance minimale de 20 cm entre l'appareil et toutes les personnes. Aucune autre antenne d'émission n'est autorisée à être située à moins de 20 cm de l'appareil.

---

## ■ FCC Information

This equipment has been tested and found to comply with the limits for a Class B digital device, pursuant to part 15 of the FCC Rules. These limits are designed to provide reasonable protection against harmful interference in a residential installation. This equipment generates, uses, and can radiate radio frequency energy and, if not installed and used in accordance with the instructions, may cause harmful interference to radio communications. However, there is no guarantee that interference will not occur in a particular installation. If this equipment does cause harmful interference to radio or television reception, which can be determined by turning the equipment off and on, the user is encouraged to try to correct the interference by one or more of the following measures:

- Reorient or relocate the receiving antenna.
- Increase the separation between the equipment and receiver.
- Connect the equipment into an outlet on a circuit different from that to which the receiver is connected.
- Consult the dealer or an experienced radio/TV technician for help.

**CAUTION:** Changes or modifications to this transceiver, not expressly approved by Icom Inc., could void your authority to operate this transceiver under FCC regulations.

## ■ Information FCC

Cet appareil est conforme à la partie 15 de la réglementation FCC. Son fonctionnement est soumis à la condition que cet appareil ne provoque pas d'interférences nocives. Cet équipement a été testé et reconnu conforme aux limites fixées pour un appareil numérique de classe B, conformément à la partie 15 de la réglementation FCC. Ces limites ont été fixées afin d'assurer une protection raisonnable contre les interférences nocives dans une installation résidentielle. Cet équipement génère, utilise et peut émettre un rayonnement de fréquence radio. S'il n'a pas été installé conformément aux instructions, il peut par ailleurs créer des interférences perturbant les communications radio. Toutefois, il n'y a aucune garantie que les interférences ne se produiront pas dans une installation particulière. Si cet équipement crée des interférences perturbant la réception de la radio ou de la télévision, comme cela peut être déterminé en éteignant et en allumant l'équipement, l'utilisateur est invité à essayer de corriger l'interférence en prenant une ou plusieurs des mesures ci-après :

- Réorienter ou changer de place l'antenne de réception.
- Éloigner l'équipement et le récepteur.
- Connecter l'équipement sur une prise sur un autre circuit que celui sur lequel le récepteur est connecté.
- Faire appel au revendeur ou à un technicien radio/TV expérimenté.

**MISE EN GARDE:** Tout changement ou modification, non expressément approuvé par Icom Inc., peut annuler l'autorisation de l'utilisateur à utiliser cet appareil conformément à la réglementation FCC.

## ■ Note

**A WARNING STICKER is supplied with the USA version transceiver.**

To comply with FCC regulations, this sticker must be affixed in such a location as to be readily seen from the operating controls of the radio as in the diagram to the right. Make sure the chosen location is clean and dry before applying the sticker.

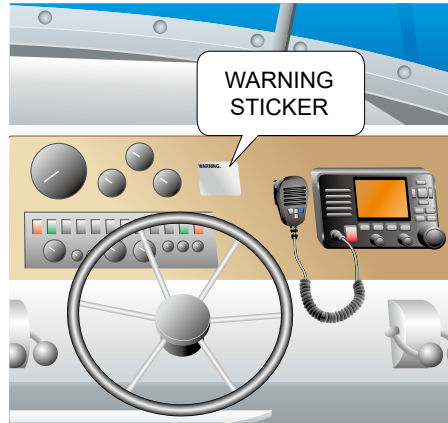

## ■ Precautions

⚠ **WARNING! NEVER** connect the transceiver directly to an AC outlet. This may cause a fire or an electric shock.

⚠ **WARNING! NEVER** connect the transceiver to a power source of more than 16 V DC such as a 24 V battery. This connection could cause a fire or damage the transceiver.

⚠ **WARNING! NEVER** reverse the DC power cable polarity. This could cause a fire or damage the equipment.

⚠ **WARNING! NEVER** cut the DC power cable between the DC power connector on the transceiver's rear panel and the fuse holder. If an incorrect connection is made after cutting, the transceiver may be damaged.

⚠ **WARNING! NEVER** operate the transceiver during a lightning storm. It may result in an electric shock, cause a fire or damage the transceiver. Always disconnect the power source and antenna before a storm.

⚠ **WARNING! NEVER** place the transceiver where normal operation of the vessel may be hindered, or where it could cause bodily injury.

**CAUTION: DO NOT** place or leave the transceiver in areas with temperatures below  $-20^{\circ}\text{C}$   $\sim$   $+60^{\circ}\text{C}$  ( $-4^{\circ}\text{F}$   $\sim$   $+140^{\circ}\text{F}$ ), or in areas subject to direct sunlight, such as a dashboard.

**CAUTION: DO NOT** use harsh solvents such as Benzine or alcohol when cleaning. This could damage the equipment surfaces. If the surface becomes dusty or dirty, wipe it clean with a soft, dry cloth.

**BE CAREFUL!** The transceiver's rear panel will become hot when transmitting continuously for long periods of time.

**BE CAREFUL!** The transceiver meets IPX8 requirements for waterproof protection\*. However, once the transceiver or microphone has been dropped, or the waterproof seal is cracked or damaged, waterproof protection cannot be guaranteed because of possible damage to the case or the waterproof seal.

\* Except for the DC power connector, NMEA In/Out leads and AF Out leads.

**NOTE:** Install the transceiver and/or microphone more than 1 meter from the vessel's magnetic navigation compass.

**NOTE:** Place the transceiver in a secure place to avoid inadvertent use by unauthorized persons.

---

## ■ Wireless LAN Information

### ◇ Precautions on using the wireless LAN

- We recommend that users with pacemakers take precautions to be sure that this device does not cause them a problem because of electromagnetic interferences.
- Do not use this device near microwave ovens. A microwave oven may cause electromagnetic interference to the communications through this device.
- Do not modify the device. The device warranty does not cover any problems caused by unauthorized modification.

### ◇ Wireless LAN installation location

**Have the following installation conditions under consideration so that the communication range and speed are not affected.**

- Install the device in a stable place where there is no danger of falling or vibration.
- Do not place anything on top of this device.
- The communication range expands in an open space. However, in such location as warehouses with metallic walls, the walls may cause the radio waves to reflect. Radio waves may pass through a wall or window, but not through metal. Some concrete walls are metal reinforcing structures, and may intercept the communication. Heat absorbing glass or IR reflecting glass may intercept the communication.
- Communication may not be able to be performed with a wireless LAN installed on a different floor.

**NOTE:** Install the transceiver within approximately 15 meters (49.2 ft) from the CT-M500, and in a place where there are no obstacles between the transceiver and the CT-M500.

---

## ■ Précautions

⚠ **AVERTISSEMENT ! NE JAMAIS** relier l'émetteur-récepteur à une prise CA. Cela pourrait provoquer un choc électrique ou un incendie.

⚠ **AVERTISSEMENT ! NE JAMAIS** brancher l'émetteur-récepteur sur une source d'alimentation supérieure à 16 V CC, comme une batterie de 24 V. Cela pourrait endommager l'émetteur-récepteur.

⚠ **AVERTISSEMENT ! NE JAMAIS** inverser la polarité du câble d'alimentation CC lors de la connexion à une source d'alimentation. Cela pourrait endommager l'émetteur-récepteur.

⚠ **AVERTISSEMENT ! NE JAMAIS** couper le câble d'alimentation CC entre la prise CC à l'arrière de l'émetteur-récepteur et le porte-fusible. L'émetteur-récepteur peut être endommagé par la suite en cas de connexion inappropriée.

⚠ **AVERTISSEMENT ! NE JAMAIS** utiliser l'émetteur-récepteur durant un orage. Cela risquerait de provoquer un choc électrique, un incendie ou d'endommager l'émetteur-récepteur. Toujours débrancher la source d'alimentation et l'antenne avant une tempête.

⚠ **AVERTISSEMENT ! NE JAMAIS** installer l'émetteur-récepteur à un emplacement où il pourrait gêner le fonctionnement normal du navire ou provoquer des blessures corporelles.

**MISE EN GARDE : NE PAS** utiliser ou placer l'émetteur-récepteur dans des zones où la température est inférieure à  $-20^{\circ}$  ou supérieure à  $+60^{\circ}$  ou dans des zones soumises au rayonnement solaire direct, telles le tableau de bord.

**MISE EN GARDE : NE PAS** utiliser de dissolvants agressifs tels que du Benzène ou de l'alcool lors du nettoyage, car ils endommageraient les surfaces de l'émetteur-récepteur. Si l'émetteur-récepteur est poussiéreux ou sale, nettoyez-le avec un tissu doux et sec.

**MISE EN GARDE :** La face arrière de la VHF chauffe en cas d'utilisation continue sur une longue durée.

**MISE EN GARDE :** L'émetteur-récepteur est étanche conformément à la norme IPX8\*. L'étanchéité ne peut plus être garantie après une chute de l'appareil en raison des risques de fissures du boîtier, de dégradation du joint d'étanchéité, etc.

\*Les connecteurs sur le panneau arrière ne sont pas étanche IPX8.

**REMARQUE: INSTALLER** la VHF et le microphone à au moins 1 m du compas de route du navire.

**REMARQUE:** Placer l'émetteur-récepteur hors de portée des enfants pour éviter toute utilisation inopinée.

Si la face avant est exposée à de l'eau de mer, **ASSUREZ-VOUS DE LE NETTOYER ENTIEREMENT AVEC DE L'EAU DOUCE** lorsque la protection étanche sur le panneau avant fonctionne. Dans le cas contraire, les touches et le commutateur risquent de ne plus fonctionner en raison de la cristallisation du sel.

---

## ■ Information Sur Le Réseau Local Sans Fil

### ◇ Précautions pour l'utilisation du réseau local sans fil

- Nous recommandons aux utilisateurs portant un stimulateur cardiaque de s'assurer que cet appareil ne cause pas de problème d'interférences électromagnétiques.
- **NE PAS** utiliser cet appareil à proximité d'un four à micro-ondes. Un four à micro-ondes peut provoquer des interférences électromagnétiques pendant les communications à l'aide de cet appareil.
- **NE PAS** modifier l'appareil. L'appareil ne couvre pas les problèmes résultant d'une modification non autorisée.

### ◇ Lieu d'installation du réseau local sans fil

**Tenir compte des conditions d'installation ci-dessous pour ne pas réduire la portée et la vitesse de communication.**

- Installer l'appareil dans un endroit stable où il ne risque pas de tomber ou d'être soumis à des vibrations.
- **NE PAS** placer d'objets sur l'appareil.
- La portée des communications s'élargit dans un espace ouvert. Cependant, dans des endroits tels que des entrepôts dont les murs sont métalliques, les ondes radio peuvent rebondir.  
Les ondes radio peuvent traverser un mur ou une fenêtre, mais pas les surfaces métalliques.  
Certains murs de béton sont armés de métal et peuvent intercepter les communications.  
Le verre anticalorique ou absorbant l'infrarouge peut intercepter les communications.
- Il pourrait être impossible d'établir la communication avec un réseau local sans fil installé sur un autre étage.

**NOTE :** Installez l'émetteur-récepteur à environ 15 mètres (49.2 ft) de l'CT-M500 et dans un endroit où il n'y a aucun obstacle entre l'émetteur-récepteur et l'CT-M500.

---

## ■ Recommendation

**CLEAN THE TRANSCEIVER AND MICROPHONE THOROUGHLY WITH FRESH WATER** after exposure to saltwater, and dry it before operating. Otherwise, the transceiver's keys and switches may become unusable, due to salt crystallization.

**NOTE:** If the transceiver's waterproof protection appears defective, carefully clean it with a soft, damp (fresh water) cloth, then, dry it before operating.

The transceiver may lose its waterproof protection if the case or microphone is cracked or broken, the microphone connector is not screwed in completely, or the transceiver has been dropped.

Contact your Icom distributor or your dealer for advice.

## ■ Key Icon Description

The keys are described in this manual as follows:

The keys that have an words or letters on them are described with the characters “[.]”

Example: [MENU], [CLEAR]

The software keys are described with the icon such as **Finish** or **DTRS**. The function of the keys are shown at the bottom of the display. Push the key below the desired function.

You can use the following keys on the Menu screen.

<b>FUNCTION</b>	<b>ACTION</b>
Select	Push [▼] or [▲], or rotate [CH/ENT].
Enter	Push [ENT], or [CH/ENT].
Go to the next tree level	Push [ENT], [▶], or [CH/ENT].
Go back to the previous tree level	Push [CLEAR], or [◀].
Cancel	Push [CLEAR] or <b>Cancel</b> .
Exit	Push [MENU] or <b>Exit</b> .

# ■ Table of Contents

■ Important.....	i
■ Explicit Definitions.....	i
■ Features.....	i
■ In Case of Emergency.....	ii
■ Radio Operation Warning.....	iii
■ Avertissement Pour Les Opérateurs Radio.....	iv
■ FCC Information.....	v
■ Information FCC.....	v
■ Note.....	vi
■ Precautions.....	vi
■ Wireless LAN Information.....	vii
■ Précautions.....	viii
■ Information Sur Le Réseau Local Sans Fil.....	ix
■ Recommendation.....	x
■ Key Icon Description.....	x
<b>1 OPERATING RULES.....</b>	<b>1</b>
<b>2 PANEL DESCRIPTION.....</b>	<b>2</b>
■ Front panel.....	2
■ Speaker Microphone.....	3
■ Function Display (INFO screen).....	4
■ Software Keys.....	6
<b>3 PREPARATION.....</b>	<b>8</b>
■ Entering the MMSI code.....	8
<b>4 BASIC OPERATIONS.....</b>	<b>10</b>
■ Selecting a channel.....	10
■ Weather channels and Weather Alert.....	11
■ Adjusting the volume/squelch/ backlight/display mode.....	12
■ Setting the Call channel.....	13
■ Receiving and transmitting.....	13
■ AquaQuake Water Draining function.....	14
■ Editing a channel name.....	14
■ Microphone Lock function.....	15
<b>5 SCAN OPERATION.....</b>	<b>16</b>
■ Scan types.....	16
■ Setting Favorite channels.....	17
■ Starting a scan.....	17
<b>6 DUALWATCH/TRI-WATCH.....</b>	<b>18</b>
■ Description.....	18
■ Operation.....	18

## **7 DIGITAL SELECTIVE CALLING**

<b>(DSC).....</b>	<b>19</b>
■ DSC address ID.....	19
■ Entering the position and time.....	20
■ Sending DSC calls (Distress).....	21
■ Sending DSC calls (other).....	25
■ Receiving DSC calls (Distress).....	35
■ Receiving DSC calls (other).....	38
■ DSC Log.....	43
■ Multiple-task mode.....	44
■ DSC Settings.....	46
■ Making an Individual call to an AIS target.....	48

## **8 AIS FUNCTION.....**

■ About AIS.....	50
■ AIS classes.....	50
■ Using the Plotter screen.....	51
■ Using the AIS list screen.....	54
■ Setting a Friend.....	56
■ About the Detail screen.....	57
■ AIS settings.....	59

## **9 OTHER FUNCTIONS.....**

■ Waypoint.....	62
■ MOB (Man Overboard).....	65
■ Anchor Watch.....	66
■ Navigation.....	67
■ Lost target.....	71
■ Using the Intercom.....	72
■ Using the RX Hailer.....	73
■ Using the Hailer.....	74
■ Using the Horn function.....	75
■ Using the Voice Scrambler.....	76
■ Command microphone operation.....	77

## **10 MENU SCREEN.....**

■ Using the Menu screen.....	79
■ Menu items description.....	82

## **11 WLAN SETTING.....**

■ Connecting to the IC-M510.....	88
■ Power Link function.....	92
■ NMEA over WLAN settings.....	92
■ Reset the WLAN settings.....	93
■ WLAN Information.....	93



---

<b>12 CONNECTIONS AND MAINTENANCE.....</b>	<b>94</b>
■ Supplied accessories .....	94
■ Connections .....	95
■ Cleaning .....	96
■ Connecting to the MA-510TR.....	96
■ Fuse replacement .....	96
■ Mounting the transceiver.....	97
■ MBF-7 installation .....	98
■ Microphone installation .....	99
<b>13 SPECIFICATIONS AND OPTIONS.....</b>	<b>101</b>
■ Specifications .....	101
■ Options.....	104
<b>14 TROUBLESHOOTING .....</b>	<b>105</b>
<b>15 CHANNEL LIST .....</b>	<b>107</b>
■ For IC-M510.....	107
<b>16 TEMPLATE.....</b>	<b>110</b>

## ◇ Priorities

- Read all rules and regulations pertaining to priorities and keep an up-to-date copy handy. Safety and distress calls take priority over all others.
- You must monitor Channel 16 when you are not operating on another channel.
- False or fraudulent distress calls are prohibited under law.

## ◇ Privacy

- Information overheard but not intended for you cannot lawfully be used in any way.
- Indecent or profane language is prohibited.

## ◇ Radio licenses

### (1) SHIP STATION LICENSE

You must have a current radio station license before using the transceiver. It is unlawful to operate a ship station which is not licensed.

Inquire through your dealer or the appropriate government agency for a Ship-Radiotelephone license application. This government-issued license states the call sign which is your craft's identification for radio purposes.

### (2) OPERATOR'S LICENSE

A Restricted Radiotelephone Operator Permit is the license most often held by small vessel radio operators when a radio is not required for safety purposes.

The Restricted Radiotelephone Operator Permit must be posted or kept with the operator. Only a licensed radio operator may operate a transceiver.

However, non-licensed individuals may talk over a transceiver if a licensed operator starts, supervises, ends the call and makes the necessary log entries.

A current copy of the applicable government rules and regulations is only required to be on hand for vessels in which a radio telephone is compulsory. However, even if you are not required to have these on hand it is your responsibility to be thoroughly acquainted with all pertinent rules and regulations.

**NOTE:** Even though the IC-M510 is capable of operation on VHF marine channels 1021, 1023, 1081, 1082, and 1083, according to FCC regulations these simplex channels cannot be lawfully used by the general population in USA waters.

## ■ Front panel

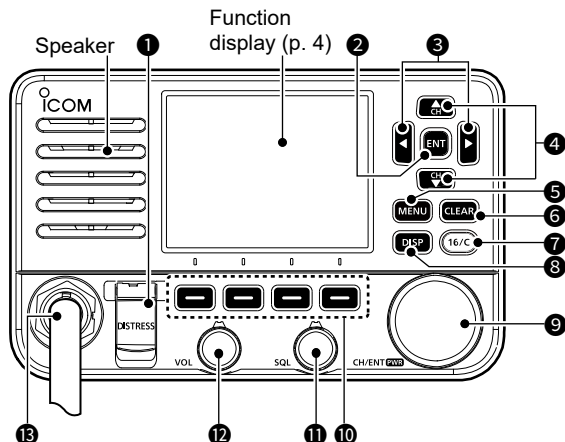

### 1 DISTRESS KEY [DISTRESS]

Hold down for 3 seconds to transmit a Distress call. (p. 21)

### 2 ENTER KEY [ENT]

Push to set the entered data, selected item, and so on.

### 3 LEFT/RIGHT KEYS [◀]/[▶]

- Push to scroll the Software Key functions. (pp. 6 ~ 7)
- Push to select a character or number in the entry mode. (pp. 8, 14, 19~20)

### 4 UP/DOWN KEYS [▲]/[▼]

- Push to select an operating channel, Menu items, Menu settings, and so on. (p. 10)
- Push to select a character or number in the entry mode. (pp. 14, 19~20)

### 5 MENU KEY [MENU]

Push to display or close the Menu screen.

### 6 CLEAR KEY [CLEAR]

Push to cancel the entered data or to return to the previous screen.

### 7 CHANNEL 16/CALL CHANNEL KEY [16/C]

- Push to select Channel 16. (p. 10)
- Hold down for 1 second to select the Call channel. (p. 10)

### 8 DISPLAY KEY [DISP]

Push to switch the main screen between the INFO, the Plotter, and the Highway screens.

### 9 CHANNEL/ENTER/POWER [CH/ENT]/[PWR]

- Hold down for 1 second to turn the transceiver ON or OFF.
- Rotate to select the operating channels, Menu items, Menu settings, and so on.
- Push to set the entered data, selected item, and so on.

### 10 SOFTWARE KEYS (pp. 6 ~ 7)

Scroll the key functions pushing [◀] or [▶], then push either of the 4 software keys to select the function displayed at the bottom of the display.

### 11 SQUELCH KEY [SQL] (p. 12)

Rotate to adjust the squelch level.

### 12 VOLUME KEY [VOL] (p. 12)

Rotate to adjust the volume level.

### 13 MICROPHONE CONNECTOR

**CAUTION:** Be sure that the microphone connector is tightened completely (rotate clockwise) to maintain the transceiver's waterproof protection.

---

## 2 PANEL DESCRIPTION

### ■ Speaker Microphone

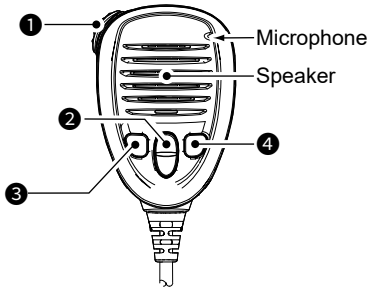

- ❶ **PTT SWITCH [PTT] (p. 13)**  
Hold down to transmit, release to receive.
- ❷ **UP/DOWN KEYS [▲]/[▼] (p. 13)**  
Push to select the Favorite channels, change scanning direction or manually resume a scan.
  - ① When the “FAV on MIC” item is set to “OFF,” you can select all channels. (p. 85)
- ❸ **TRANSMIT POWER KEY [H/L]**
  - Push to set the power level to high or low.
    - ① Some channels are set to only low power.
  - You can turn the Microphone Lock function ON or OFF by turning the transceiver ON while holding down this key. (p. 15)
- ❹ **CHANNEL 16/CALL CHANNEL KEY [16/C] (p. 10)**
  - Push to select Channel 16.
  - Hold down for 1 second to select the Call channel.
    - The “CALL” icon is displayed.

## Function Display (INFO screen)

① When you switch the main screen between the INFO, the Plotter, and the Highway screens, push [DISP].

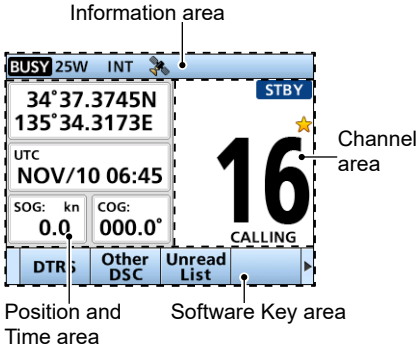

### ◇ Position and Time area

#### POSITION AREA

The current position is displayed when valid GPS data is received, or you manually enter your position.

Indicator	Description
<b>NO POSITION</b>	Displayed when a GPS antenna is not connected or your position has not been manually entered.
<b>??</b>	Blinks every 2 seconds instead of your position when the GPS position is invalid. ① The last position is held for only 23.5 hours. After that, "NO POSITION" will be displayed.
	Blinks every 2 seconds instead of the position after 4 hours have passed since you manually entered your position. ① The manually entered position is held for only 23.5 hours. After that, "NO POSITION" will be displayed.

#### TIME AREA

The current time and is displayed when valid GPS data is received, or manually enter the time.











Indicator	Description
<b>NO TIME</b>	Displayed when a GPS antenna is not connected or the time has not been manually entered.
<b>Local</b>	Displayed when the offset time is set.
<b>Manual</b>	Displayed when the time was manually entered.
<b>UTC</b>	Displayed when the date information received from the built-in GPS receiver, an external NMEA 0183, or external NMEA 2000 sentence source. ① The offset time must not set.
<b>??</b>	Blinks every 2 seconds instead of the time when the GPS current time is invalid. ① After 23.5 hours has passed, "NO TIME" will be displayed.
	Blinks every 2 seconds instead of the time after 4 hours have passed since you manually entered the time. ① The manually entered time is held for only 23.5 hours. After that, "NO TIME" will be displayed.



① Position and Time area also displays your vessel's SOG (Speed Over Ground) and COG (Course Over Ground).

## 2 PANEL DESCRIPTION

### ◇ Information area



The following indicators are displayed in the Information area.

Indicator	Description
	Displayed when receiving a signal or when the squelch is open.
	Displayed while transmitting.
<b>25W</b>	Displayed when high power is selected.
<b>1W</b>	Displayed when low power is selected.
<b>USA, INT, CAN, WX</b>	Displays the selected channel group, INT (International), USA, CAN (Canada), WX (Weather channel). ① When the WX-Alert is set to ON,  is displayed.
	Displayed when the transceiver receives valid position and time data. Blinks when invalid GPS data is being received.
	Displays the WLAN signal strength while connected to a wireless network.
	<ul style="list-style-type: none"> <li>Displayed while accessing to the optional CT-M500.</li> <li>In the Client mode,  displays the WLAN signal strength.</li> </ul>
	Displayed when the Auto Foghorn function is activated. (p. 75)
	Displayed when the battery voltage is low
	Displayed while accessing to the mobile device using the RS-M500. ① The number indicates the number of connected mobile devices.
	Displayed when there is a target in the CPA/TCPA alarm function.

	<ul style="list-style-type: none"> <li>Displayed when there are unread DSC messages.</li> <li>Blinks when a DSC message is received.</li> </ul>
	Displayed when the “CH Auto Switch” in DSC Settings is set to an option except “Accept.”

### ◇ Channel area

The selected operating channel number, channel name, and the following indicators are displayed in the Channel area.

Indicator	Description
	Displayed when a Favorite channel is selected.
<b>CALL</b>	Displayed when the Call channel is selected by holding down [16/C] for 1 second.
<b>DUP</b>	Displayed when a Duplex channel is selected.
<b>STBY</b>	Displayed while in the Standby mode.
<b>RT</b>	Displayed while in the Radio Telephone (RT) mode. ① Returns to the Standby mode if no operation occurs during the preset period of time.
<b>DSC</b>	Displayed after making or receiving a DSC call. ① If the transceiver is in the Multiple Task mode, the number of DSC tasks is displayed by the indicator.
<b>RX</b> 	Displayed when in the RX Hailer mode. (p. 73)
<b>SCAN 16</b>	Displayed during a Priority scan. (p. 17)
<b>SCAN</b>	Displayed during a Normal scan. (p. 17)
<b>DUAL 16</b>	Displayed during Dualwatch. (p. 18)
<b>TRI 16</b>	Displayed during Tri-watch. (p. 18)

## ■ Software Keys

Various often-used functions are assigned to the Software Keys for easy access. The functions' icons are displayed above the Software Keys, as shown below.

### ◇ Selecting a Software Key function

Push [◀] or [▶] to slide through the selectable functions that are assigned to the Software Keys.  
Push the Software Key under the function's icon to select the function.

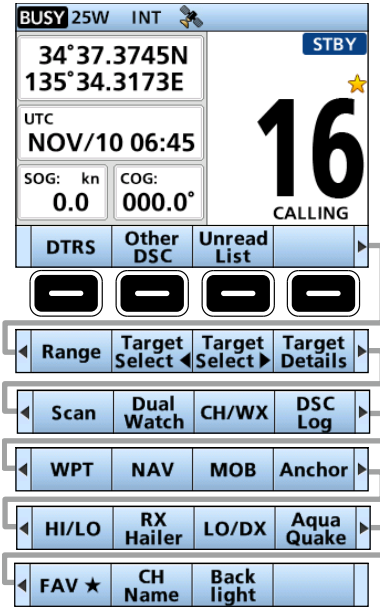

**NOTE:** The displayed icons or their order may differ, depending on the transceiver version or the presetting. When the MMSI code is not set, the Software Keys for the DSC function are not displayed.

## ◇ Software key functions

### Compose Distress [DTRS] (p. 22)

Push to display the “Compose Distress” screen to select the nature of distress, then to make a call.

*NEVER MAKE A DISTRESS CALL IF YOUR SHIP OR A PERSON IS NOT IN AN EMERGENCY. A DISTRESS CALL SHOULD BE MADE ONLY WHEN IMMEDIATE HELP IS NEEDED.*

### Other DSC (p. 25)

Push to compose an Individual call, Group call, All Ships call or a Test call, and so on.

### Unread List

Push to enter the Unread List.

- ① Displayed only when “Single” is selected in the DSC procedure menu. (p. 47)

### Task List (p. 44)

Push to enter the Task List.

- ① Displayed only when “Multiple” is selected in the DSC procedure menu. (p. 47)

### Range (p. 52)

Push to select the plotter display range on the Plotter screen.

- ① Displayed only on the plotter screen.

### Target Select ◀ / Target Select ▶ (p. 52)

Push to select an AIS target, waypoint, or MOB.

- ① Displayed only on the plotter screen.

### Target Details (p. 57)

Push to display the details on the selected target.

- ① Displayed only on the plotter screen.

### Scan (p. 17)

Push to start or stop a Normal or Priority scan.

### Dualwatch/Tri-watch (p. 18)

Push to start or stop the Dualwatch or Tri-watch.

---

## 2 PANEL DESCRIPTION

### ◇ Software key functions

#### **Channel/Weather channel**

##### **[CH/WX] (p. 11)**

Push to select regular channels or Weather channels.

- ① While the Call channel or Channel 16 is displayed, push this key to return to the regular channel mode.

##### **DSC Log (p. 43)**

Push to display the received call log or distress message log.

##### **Waypoint [WPT] (p. 63)**

Push to save your position information to the transceiver.

##### **Navigation [NAV]/[Stop NAV] (p. 67)**

Push to start navigation.

While navigating, push to stop navigation.

#### **Man Overboard**

##### **[MOB]/[Stop MOB] (p. 65)**

Push to enter the Man Overboard (MOB) mode.

While in the Man Overboard (MOB) mode, push to stop the Man Overboard (MOB) mode.

#### **Anchor**

##### **[Anchor]/[Stop Anchor] (p. 66)**

Push to start or stop the Anchor watch function.

##### **High/Low [HI/LO] (p. 3)**

Push to set the output power level to high or low.

- ① Some channels are set to only low power.

##### **Voice Scrambler [Voice SBL] (p. 76)**

Push to set the Voice Scrambler function.

- ① This function is displayed only when the voice scrambler unit is installed.

##### **RX Hailer (p. 73)**

Push to display the RX Hailer popup screen.

- ① To use this function, the external hailer speaker must be connected to the CT-M500, and the CT-M500 must be connected to the IC-M510.

##### **LO/DX (p. 85)**

Push to turn the Attenuator function ON or OFF.

- ① The "LOC" icon is displayed when the Attenuator function is ON.

##### **AquaQuake (p. 14)**

Hold down to turn ON the AquaQuake function to clear water from the speaker grill.

##### **Favorite [FAV★] (p. 17)**

Push to set or clear the displayed channel as a Favorite channel.

##### **CH Name (p. 14)**

Push to edit the name of the displayed channel.

##### **Backlight (p. 12)**

Push to display the Backlight popup screen.

In the Backlight popup screen, you can set the backlight level, and the display mode.



## ■ Entering the MMSI code

The Maritime Mobile Service Identity (MMSI: DSC self ID) code consists of 9 digits. You can only enter the code when turning ON the transceiver for the first time.

**This initial code can be entered only once.**

After entering, it can be changed only by your dealer or distributor.

If your MMSI code has already been entered, doing the steps below is not necessary.

2

3

1. Hold down [PWR] to turn ON the transceiver.
  - Three short beeps sound, and “Push [ENT] to Register your MMSI” is displayed.
2. Push [ENT] to start entering the MMSI code.
  - The “MMSI INPUT” screen is displayed.
  - ① Push [CLEAR] twice to skip the entry.
    - If you skip the entry, you cannot make a DSC call. To enter the code after skipping, turn OFF the power, and then turn it ON again.
3. Enter the MMSI code.

**TIP:**

- Select a number using [◀] and [▶].
- Push [ENT] or [CH/ENT] to enter the selected number.
- Select “←” or “→” on the screen, or rotate [CH/ENT] to move the cursor.

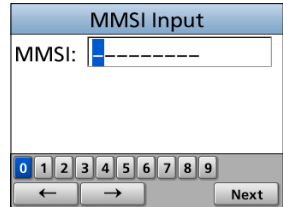

4. Repeat step 3 to enter all 9 digits.
5. Select **Next** and push [ENT] or [CH/ENT] to set the entered code.
  - The “MMSI Confirmation” screen is displayed.

---

## 3 PREPARATION

### ■ Entering the MMSI code

6. Enter your MMSI code again to confirm.



7. Push **Finish** to set the entered code.

- When your MMSI code is successfully entered, “MMSI registered successfully.” is briefly displayed, and then enters the operating screen.

① Your MMSI code is also displayed on the opening screen.



## ■ Selecting a channel

### ◇ Regular Channel

You can select a channel by pushing [▲] or [▼].

### ◇ Channel 16

Channel 16 is the distress and safety channel. It is used to establish the initial contact with a station, and for emergency communications. Channel 16 is monitored during both Dualwatch and Tri-watch. While in the standby mode, you must monitor Channel 16.

- Push [16/C] to select Channel 16.
  - ① To return to the previously selected channel, push [◀] or [▶] to display **CH/WX**, and then push the software key below **CH/WX**.



### ◇ Call channel

Each Channel Group has separate leisure-use Call channels. The Call channel is scanned during Tri-watch. The Call channels can be selected and used to store your most often used channels in each Channel Group, for quick recall. See page 13 for details on setting the Call channel.

- Hold down [16/C] for 1 second to select the Call channel.
  - The Call channel number and “CALL” are displayed.
  - ① To return to the previously selected channel, push [◀] or [▶] to display **CH/WX**, and then push the software key below **CH/WX**.



### ◇ Selecting a Channel Group

Channel Groups are preset into your transceiver. You can select a Channel Group for USA, International, and Canadian, depending on the transceiver version.

1. Open the “Channel Group” screen.
  - [MENU] > Settings > Radio > **Channel Group**
2. Push [▲] or [▼], or rotate [CH/ENT] to select a Channel Group, and then push [ENT], or [CH/ENT].
3. Push [MENU] to exit the Menu screen.
4. The selected Channel Group's icon is displayed on the operating screen.

3  
4

## 4 BASIC OPERATIONS

### ■ Weather channels and Weather Alert

The transceiver has 10 preset Weather channels.

The transceivers are capable\* of monitoring broadcasts from the National Oceanographic and Atmospheric Administration (NOAA). The transceiver automatically detects a Weather alert tone on the selected weather channel, or while scanning.

\*When used within range of the broadcasts.

#### ◇ Selecting a Weather channel

1. Push [CH/WX].
  - “WX” is displayed on the operating screen instead of the Channel Group.
2. Push [▲] or [▼], or rotate [CH/ENT] to select a Weather channel.

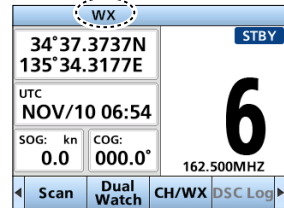



#### The Weather channel list

WX channel	Frequency (MHz)	WX channel	Frequency (MHz)
1	162.550	6	162.500
2	162.400	7	162.525
3	162.475	8	161.650
4	162.425	9	161.775
5	162.450	10	163.275

#### ◇ Setting the Weather Alert

To receive the weather alert, set the WX Alert to “ON with Scan,” or “ON.”

1. Open the “Weather Alert” screen.
    - [MENU] > Settings > Radio > **WX Alert**
  2. Select “ON with Scan,” or “ON.”
    - “” is displayed next to the weather channel icon.
- ① “WX” blinks until you push a key after detecting an alert.

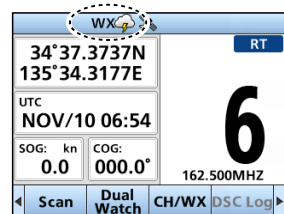

## ■ Adjusting the volume/squelch/backlight/display mode

### ◇ Adjusting the volume level

- Rotate [VOL] to adjust the audio volume level.

### ◇ Adjusting the squelch level

Squelch enables the audio to be heard only while receiving a signal that is stronger than the set level. A higher level blocks weak signals, so that you can receive only stronger signals. A lower level enables you to hear weak signals.

- Rotate [SQL] to adjust the squelch level.

### ◇ Adjusting the backlight and the display mode

The Function display and keys can be backlit for better visibility under low light conditions. And, you can set the display mode to Day mode or Night mode.

The Day mode is for the daytime operation, and the screen items are in full color.

The Night mode is for the nighttime operation, and the screen items are in black and red.

1. Open the "Backlight" screen.

[MENU] > Settings > Configuration > **Backlight**

- ① You can also push **Back light** to open the "Backlight" popup screen.
2. Push [◀] or [▶] or rotate [CH/ENT] to adjust the backlight level.
  - The backlight level is set, and the transceiver returns to the previous screen.
- ① The backlight level is adjustable in 7 levels and "OFF." "OFF" is selectable only for the Day mode.

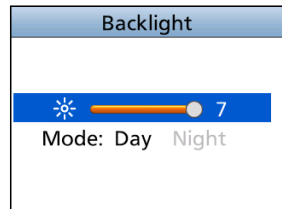

3. Push [▼], then push [◀] or [▶] or rotate [CH/ENT] to select "Day" or "Night."

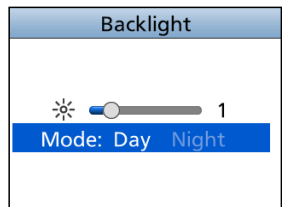

4. Push [ENT] or [CH/ENT] to exit the Menu screen.

## 4 BASIC OPERATIONS

### ■ Setting the Call channel

By default, a Call channel is set in each Channel Group.

You can set your most often-used channel as your Call channel in each Channel Group for quick recall.

1. Open the “Call Channel” screen.

[MENU] > Settings > Radio > **Call Channel**

2. Push [▲] or [▼], or rotate [CH/ENT] to select the channel.
3. Push [ENT] or [CH/ENT] to set the selected channel as the Call channel.
4. Push [MENU] to exit the Menu screen.

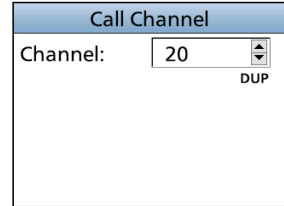

### ■ Receiving and transmitting

**CAUTION: DO NOT** transmit without an antenna.

1. Push [▲] or [▼], or rotate [CH/ENT] to select a channel to call on.
  - The channel number and name are briefly displayed.
  - Ⓢ **BUSY** is displayed while receiving a signal.
2. Hold down [PTT] and speak into the microphone at your normal voice level.
  - **TX** is displayed while transmitting.
3. Release [PTT] to receive.

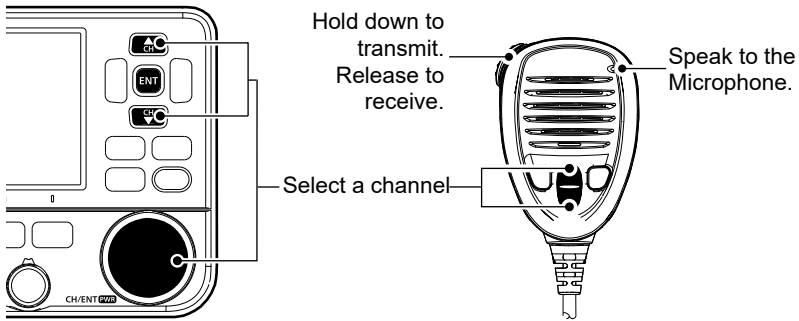

**TIP:** To maximize the readability of your transmitted signal, pause for a second after holding down [PTT] and hold the microphone 5 to 10 cm (2 to 4 inches) from your mouth, and then speak at your normal voice level.

**NOTE:** The Time-out Timer function cuts OFF transmission after 5 minutes of continuously transmitting, to prevent prolonged transmission.

## ■ AquaQuake Water Draining function

Water in the speaker grill may muffle the sound coming from the speaker. The AquaQuake Water Draining function removes water from the speaker grill by vibrating the speaker cone.

**CAUTION: DO NOT** use the AquaQuake Water Draining function when an external speaker is connected.

1. Push [◀] or [▶] to display **AquaQuake**.
2. Hold down **AquaQuake** to turn ON the function.
  - A low frequency vibration beep sounds to drain the water, regardless of the volume level setting.
  - ⓘ This function is activated for a maximum of 10 seconds, even if you continue to hold down **AquaQuake**.
3. Release the key to turn OFF the function.



## ■ Editing a channel name

You can edit the name of each operating channel and weather channel, using numbers, uppercase letters, symbols, and a space. This enables easy recognition of the channels or stations. All VHF marine channels are set with default names.

1. Push [▲] or [▼], or rotate [CH/ENT] to select the channel to edit.
2. Push [◀] or [▶] to display **CH Name**.
  - ⓘ You cannot edit a channel name during Dualwatch, Tri-watch, or a scan.
3. Push **CH Name**.
  - The “Channel Name” screen is displayed.
4. Edit the channel name.
5. Select **Finish**, and then push [ENT] or [CH/ENT] to save the edited name and return to the operating screen.



**TIP:**

- Select **A1** to enter numbers and letters, and **IS?** to enter symbols.



- Select a number, character, or space using [▲], [▼], [◀], and [▶].
- Push [ENT] or [CH/ENT] to enter the selected number or character.
- Select “←” or “→” on the screen or rotate [CH/ENT] to move the cursor, or to select the entered character.

---

## 4 BASIC OPERATIONS

### ■ Microphone Lock function

The Lock function electronically locks all keys on the microphone except [PTT] to prevent accidental channel changes or functions access.

1. Hold down [PWR] for 1 second to turn OFF the transceiver.
2. While holding down [H/L] on the microphone, hold down [PWR] for 1 second to turn the Lock function ON or OFF.

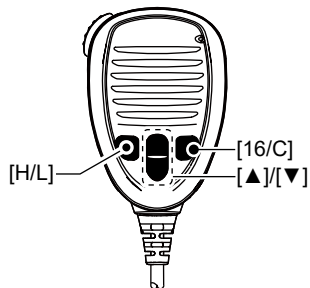



## Scan types

You can find ongoing communication by scanning the Favorite channels.

### Before starting a scan :

- Set the channels that you want to scan as Favorite channels. (p. 17)
  - ① Only the Favorite channels are scanned.
- Set the scan type to “Priority Scan” or “Normal Scan” on the “Radio Settings” screen. (p. 84)

[MENU] > Settings > Radio > **Scan Type**

4

5

### Normal Scan

Sequentially searches through all Favorite channels. Channel 16 is not scanned unless it is set as a Favorite channel.

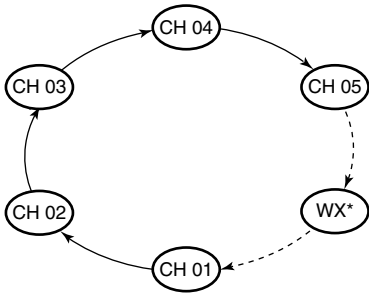

\*When the Weather Alert function is ON, the previously selected Weather channel is also scanned.

### Priority Scan

Sequentially searches through all Favorite channels, while also periodically checking Channel 16.

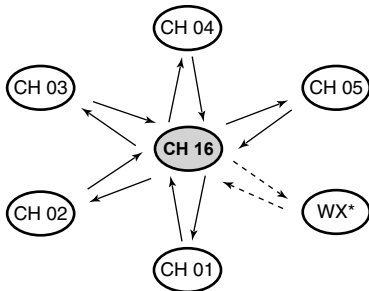

\*When the Weather Alert function is ON, the previously selected Weather channel is also scanned.

### When a signal is received:

**On Channel 16:**

The scan pauses until the signal disappears.

**On a channel other than Channel 16:**

The scan becomes Dualwatch until the signal disappears.

## 5 SCAN OPERATION

### ■ Setting Favorite channels

You can quickly recall often-used channels by setting them as Favorite channels. You can set Favorite channels in each Channel Group.

1. Select a Channel Group on the Menu screen. (p. 10)

[MENU] > Settings > Radio > **Channel Group**

2. Push [▲] or [▼], or rotate [CH/ENT] to select the channel.
3. Push [◀] or [▶] to display **FAV★**.
4. Push **FAV★**.
  - The selected channel is set as a Favorite channel, and “★” is displayed.
  - ① To cancel the setting, push **FAV★** again.

**TIP:** You can set all channels as Favorite channels, clear all settings, or reset to the defaults. By default, some channels are preset as Favorite channels. The preset channels differ, depending on the transceiver version.

### ■ Starting a scan

**Example:** Starting a Normal Scan.

1. Select a Channel Group on the Menu screen. (p. 10)

[MENU] > Settings > Radio > **Channel Group**

2. Push [◀] or [▶] to display **Scan**.
3. Push **Scan**.
  - The scan starts.
  - “SCAN” is displayed during a Normal Scan, and “SCAN 16” is displayed during a Priority Scan.
  - “SCAN” and “**BUSY**” are displayed when a signal is received.
  - ① When a signal is received, the scan pauses until it disappears, or resumes after 5 seconds, depending on the Scan Timer setting in “Radio Settings.”
  - ① A beep sounds and “16” blinks when a signal is received on Channel 16 during a Priority scan.
4. To stop the scan, push **Scan**.

**TIP:** To properly receive signals, be sure to adjust the squelch to a suitable level.

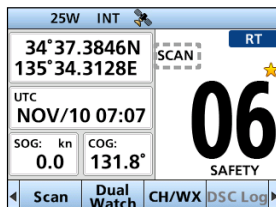
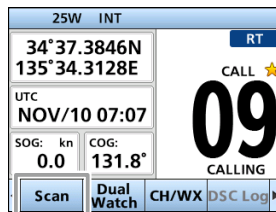

## Description

Dualwatch and Tri-watch are convenient to periodically check Channel 16 while you are operating on another channel.

### Dualwatch

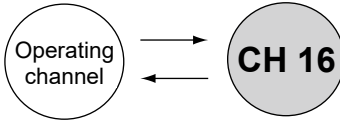

Periodically checks Channel 16 while operating on another channel.

### Tri-watch

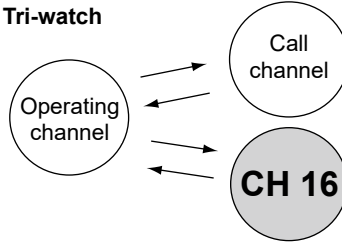

Periodically checks Channel 16 and the Call channel while operating on another channel.

### When a signal is received:

**On Channel 16:** Dualwatch/Tri-watch pauses on Channel 16 until the signal disappears.

**On the Call channel:** Tri-watch switches to Dualwatch until the signal on the Call channel disappears.

## Operation

- Select Dualwatch or Tri-watch on the Menu screen.  
 [MENU] > Settings > Radio > **Dual/Tri-Watch**
- Push [▲] or [▼], or rotate [CH/ENT] to select a channel.
- Push [◀] or [▶] to display **Dual Watch** or **TRI Watch**.
- Push **Dual Watch** or **TRI Watch**.
  - Dualwatch or Tri-watch starts.
  - “DUAL 16” is displayed for Dualwatch, or “TRI 16” is displayed for Tri-watch.
  - ① “BUSY” is displayed when a signal is received.
  - ① A beep tone sounds and “16” starts to blink when a signal is received on Channel 16.
- To cancel Dualwatch or Tri-watch, push **Dual Watch** or **TRI Watch** again.

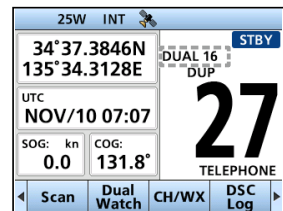
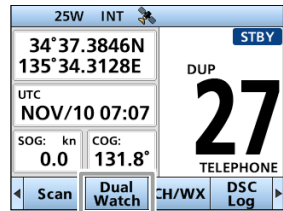

## ■ DSC address ID

### ◇ Entering an Individual or Group ID

You can enter a total of 75 Individual IDs and 25 Group IDs, and assign names to them of up to 10 characters.

1. Open the “Individual ID” or “Group ID” screen.

[MENU] > Settings > DSC > **Individual ID**

[MENU] > Settings > DSC > **Group ID**

2. Push **Add**.
  - “No ID” is displayed if no ID is entered.
3. Enter an Individual or Group ID.

#### TIP:

- Select a number using [**◀**] and [**▶**].
- Push [ENT] or [CH/ENT] to set the selected number.
- Select “←” or “→” on the screen, or rotate [CH/ENT] to move the cursor.

#### NOTE:

- For a Group ID, the first digit is fixed as “0.”
- For any coast station ID, the first two digits are fixed as “0.”

4. Push **Next** to start entering the ID’s name.

#### TIP:

- Select **A1** to enter numbers and letters, and **IS?** to enter symbols.

- Select a number, character, or space using [**▲**], [**▼**], [**◀**], and [**▶**].
- Push [ENT] or [CH/ENT] to enter the selected number or character.
- Select “←” or “→” on the screen to move the cursor, or to select the entered character.

5. After entering, push **Finish** to save, and return to the previous screen.
  - The entered name is displayed.

## ◇ Deleting an entered ID

(Example: Deleting an Individual ID: STATION 2)

1. Open the “Individual ID” screen.  
 [MENU] > Settings > DSC > **Individual ID**
2. Select “STATION 2,” and then push **Delete**.  
 • “Delete the ID. Are You Sure?” is displayed.
3. Push **OK** to delete.  
 ⓘ Push **Cancel** to cancel the deletion.  
 • The selected ID is deleted, and then returns to the previous screen.

**TIP:** You can edit an ID and its name by pushing **Edit** in step 2.

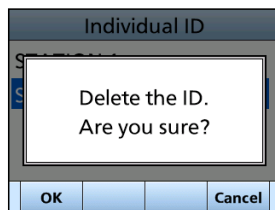
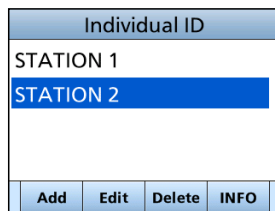

## ■ Entering the position and time

A Distress call should include the vessel’s position, date, and time. If no GPS data is received, manually enter the position and Universal Time Coordinated (UTC) time.

**NOTE:**

- The manual entry is disabled while valid GPS data is received.
- The manually entered position and time is valid only for 23.5 hours, or until turning OFF the transceiver.

1. Open the “Position Input” screen.  
 [MENU] > Settings > DSC > **Position Input**

2. Enter the latitude.

**TIP:**

- Select a number or a compass direction using [▲], [▼], [◀], and [▶].
- Select “←” or “→” on the screen, or rotate [CH/ENT] to move the cursor.
- Select **Next** and then push [ENT] or [CH/ENT] to save the selected number.

3. Enter the longitude and the UTC time.  
 ⓘ See the TIP in step 2 to enter.
4. After entering, push **Finish** to save, and return to the previous screen.  
 • The “DSC” screen is displayed.

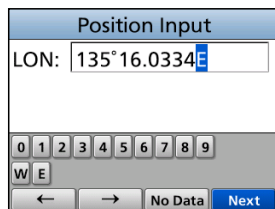
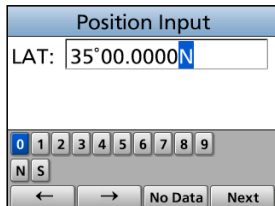

# 7 DIGITAL SELECTIVE CALLING (DSC)

## ■ Sending DSC calls (Distress)

A Distress call should be sent if, in the opinion of the captain, the ship or a person is in distress and requires immediate assistance.

**NEVER MAKE A DISTRESS CALL IF YOUR SHIP OR A PERSON IS NOT IN AN EMERGENCY. A DISTRESS CALL SHOULD BE MADE ONLY WHEN IMMEDIATE HELP IS NEEDED.**

### ◇ Simple call

1. Confirm that no Distress call is being received.
2. While lifting up the key cover, hold down [DISTRESS] for 3 seconds until you hear 3 short countdown beeps and a long beep sound.
  - The backlight blinks.

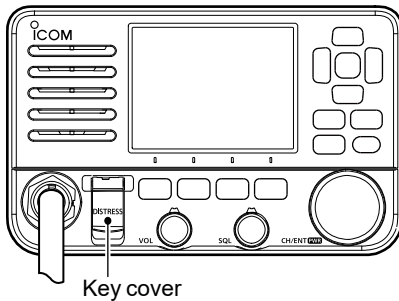

3. After sending, wait for an Acknowledgment call.
  - "Waiting for ACK" is displayed.
  - The Distress call is automatically sent every 3.5 to 4.5 minutes, until an Acknowledgment is received, or a Distress Cancel call is sent.
4. When you receive an Acknowledgment, an alarm sounds. Push **Alarm OFF** to turn OFF the alarm.
  - Channel 16 is automatically selected.
5. Push **Close Window**.
6. Hold down [PTT], and then explain your situation.
7. After you have finished your conversation, push **STBY**.
  - "Terminate the procedure. Are you sure?" is displayed.
8. Push **OK** to return to the operating screen.

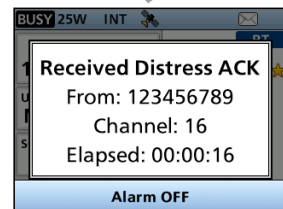
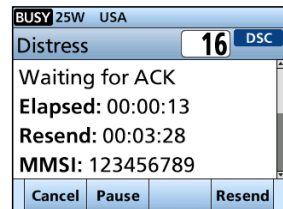
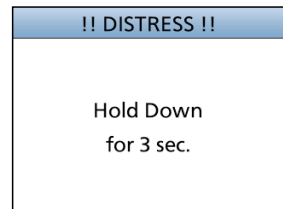

**TIP:** A default Distress alert contains:

- Nature of distress: Undesignated distress
- Position information: The latest GPS, or manually input position, that is held for 23.5 hours, or until you turn OFF the transceiver.

◇ **Regular call**

Select the nature of the Distress call to include in the Regular Distress call.

1. Push **[DTRS]**.
  - The “Compose Distress” screen is displayed.
2. Push **[ENT]** or **[CH/ENT]** to enter the Nature selection mode.
3. Select the nature of the Distress, and then push **[ENT]** or **[CH/ENT]**. (Example: Flooding)
  - The setting is saved and returns to the previous screen.
  - ① If no valid GPS data is being received, select “Position,” and then enter the latitude, longitude, and UTC. See “Entering the position and time” on page 20 for details.
4. While lifting up the key cover, hold down **[DISTRESS]** (the red button) for 3 seconds until you hear 3 short countdown beeps and a long beep sound.
  - The backlight blinks.

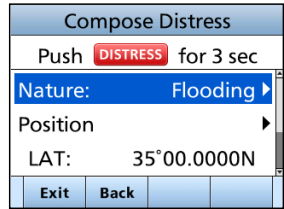

5. After sending, wait for an Acknowledgment.
  - “Waiting for ACK” is displayed.
  - ① The Distress call is automatically sent every 3.5 to 4.5 minutes, until an Acknowledgment is received, or a Distress Cancel call is sent. (p. 23)

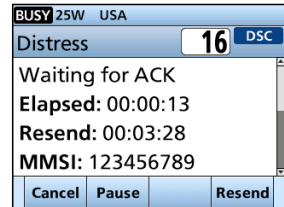

6. When you receive an Acknowledgment, an alarm sounds. Push **[Alarm OFF]** to turn OFF the alarm.
  - Channel 16 is automatically selected.
7. Hold down **[PTT]** to communicate.
8. After you have finished your conversation, push **[STBY]**.
  - “Terminate the procedure. Are you sure?” is displayed.
9. Push **[OK]** to return to the operating screen.

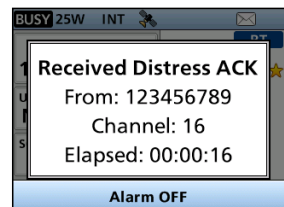

**TIP:** You can also send a Regular call by selecting the “Distress” item on the Menu screen.

# 7 DIGITAL SELECTIVE CALLING (DSC)

## ◇ Distress Cancel call

If you have accidentally made a Distress call, or made an incorrect Distress call, send a Distress Cancel call to cancel the call as soon as possible while waiting for an Acknowledgment. Be sure to report the purpose of the cancellation.

1. While waiting for an Acknowledgment, push **Cancel**.
  - The screen to the right is displayed.
2. Push **OK**.
  - The Distress Cancel call is sent.
  - Channel 16 is automatically selected.

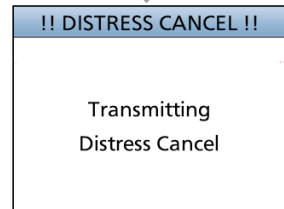
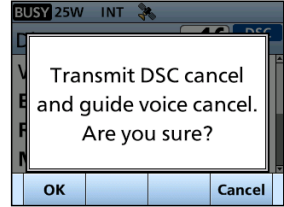

3. Hold down [PTT] to report the purpose of the cancellation.
  - ① You can display the wording of the cancellation by pushing [▼].
4. After communicating, push **Finish**.
  - ① The screen to the right is displayed.
5. Push **STBY** to finish the Distress Cancel call.
  - "Terminate the procedure. Are you sure?" is displayed.
6. Push **OK** to return to the operating screen.

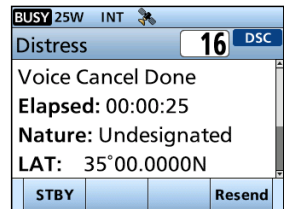
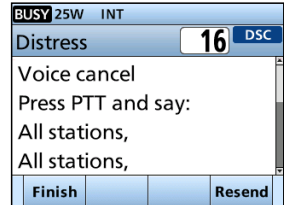

## ◇ Distress call Software Key description

### While waiting for an Acknowledgment:

- Cancel** : Cancels the Distress call and enables you to send a Cancel call.
- Resend** : Enables you to resend the Distress call by holding down [DISTRESS] again.
- Pause** : Pauses the countdown to resend the next Distress call.
- INFO** : Displays the information of the Distress call that you have sent.

### After receiving an Acknowledgment:

- STBY** : Closes the Distress operation, and returns to the operating screen.
- INFO** : Displays the information of the received Distress Acknowledgment.
- History** : Displays the "Distress History."



### ◇ Sending a Distress Relay acknowledgment

You can send the Distress Relay acknowledgment only when a Distress Relay call is received.

- When a Distress Relay call is received:
  - An alarm sounds.
  - The screen to the right is displayed.
- Push any **Alarm OFF** to turn OFF the alarm.

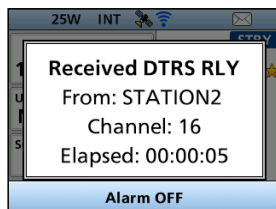

- Push **Accept**.
  - The received information is displayed.

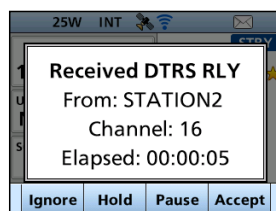

- Push **ACK**.
  - The call contents screen is displayed.
  - ① Rotate [CH/ENT] to view the call contents.



- Push **Call** to send the Distress Relay acknowledgment.
  - After sending, "Distress Relay ACK" screen is displayed.

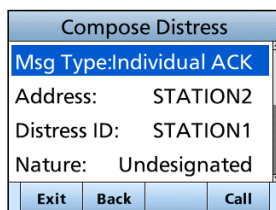

- Hold down [PTT] to communicate.
- After you have finished your conversation, push **STBY**.
  - "Terminate the procedure. Are you sure?" is displayed.
- Push **OK** to return to the operating screen.

7

# 7 DIGITAL SELECTIVE CALLING (DSC)

## ■ Sending DSC calls (other)

**NOTE:** To ensure proper DSC operation, be sure to correctly adjust the “CH 70 SQL Level” item on the Menu screen. (p. 47)

### ◇ Sending an Individual call

An Individual call enables you to send a DSC signal to only a specific station. You can communicate after receiving the Acknowledgment “Able to comply.”

**NOTE:** You can also compose an Individual call to an AIS target on the Plotter screen or the AIS list. (pp. 54, 57)

1. Push **Other DSC**.
  - The “Compose Non-Distress” screen is displayed.
  - ① You can also display the “Compose Non-Distress” screen by selecting the “Other DSC” item on the Menu screen.
2. Select “Msg Type,” and then push [ENT] or [CH/ENT].
3. Select “Individual,” and then push [ENT] or [CH/ENT].
  - Returns to the “Compose Non-Distress” screen.
4. Select “Address,” and then push [ENT] or [CH/ENT].
5. Select the station to send an Individual call to, and then push [ENT] or [CH/ENT].
  - Returns to the “Compose Non-Distress” screen.
  - ① You can also select “Manual Input” to manually enter the target station ID.
6. Select “Channel,” and then push [ENT] or [CH/ENT].
7. Select a channel to assign, and then push [ENT] or [CH/ENT].
  - ① The assigned channels are preset by default.
8. Push **Call** to send the Individual call.
  - “Transmitting Individual Call” is displayed, and then “Waiting for ACK” is displayed.
  - ① If Channel 70 is busy, the transceiver stands by until the channel becomes clear.

Compose Non-Distress		
Msg Type:	Individual ▶	
Address:	STATION 1 ▶	
Category:	Routine	
Mode:	Telephony	
Exit	Back	Call

Compose Non-Distress		
Address:	STATION 1 ▶	
Category:	Routine	
Mode:	Telephony	
Channel:	08 ▶	
Exit	Back	Call

Individual Call
Transmitting Individual Call

25W INT 	
Individual Call	DSC
Waiting for ACK	
Elapsed: 00:00:26	
To: STATION1	
Category: Routine	
STBY	Resend

9. When you receive an Acknowledgment "Able to comply":
  - An alarm sounds.
  - The screen to the right is displayed.
10. Push **Alarm OFF** to turn OFF the alarm.
  - The channel assigned in step 7 is automatically selected.
  - ① If the called station cannot use the channel that you assigned, a different channel is selected by the other station.
11. Push **Close Window**.
12. Hold down [PTT] to communicate.



**TIP:** If you received an Acknowledgment "Unable to comply":

1. Push **Alarm OFF** to turn OFF the alarm, and then push **Close Window**.
  - The Acknowledge information is displayed.
2. Push **STBY**, and then **OK** to return to the operating screen.

## ◇ Sending an Individual Acknowledgment

When you have received an Individual call (p. 38), send an Acknowledgment to the calling station. When the Auto Ack is set to "Manual," you can select an appropriate acknowledgment type.

1. While an Individual call is being received, push **Alarm OFF** to turn OFF the alarm.
  - The received call's information is displayed.
2. Push **Accept**.
  - The Acknowledgment category screen is displayed.
  - ① If you want to send an Acknowledgment "Able to comply" right away, push **Able**.
  - ① If you cannot communicate, and want to return to the operating screen, push **Ignore**.
3. Push **ACK Able**, **ACK Unable**, or **ACK New CH** to select the Acknowledgment type.

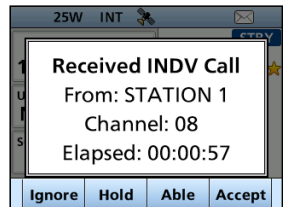

**ACK Able:** Sends an Acknowledgment without any changes.  
(Able to Comply)

**ACK Unable:** Sends an Acknowledgment but cannot communicate.  
(Unable to Comply):

**ACK New CH:** Sends an acknowledgment. You can specify the Voice Communication channel.  
(Propose New CH)  
(Example: Channel 16)

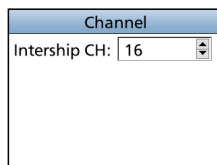
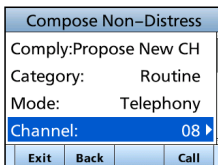
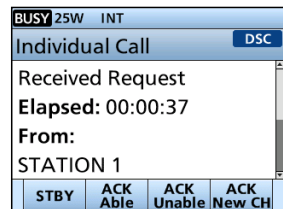

4. Push **Call** to send the Acknowledgment.

# 7 DIGITAL SELECTIVE CALLING (DSC)

## ◇ Sending an All Ships call

All Ships that have DSC transceiver use Channel 70 as their listening channel. When you want to announce a message to these ships, if they are within range, use the All Ships Call.

1. Push **Other DSC**.
  - The “Compose Non-Distress” screen is displayed.
  - ① You can also display the “Compose Non-Distress” screen by selecting the “Other DSC” item on the Menu screen.
2. Select “Msg Type,” and then push [ENT] or [CH/ENT].
  - The “Message Type” screen is displayed.
3. Select “All Ships,” and then push [ENT] or [CH/ENT].
  - The All Ships call is selected, and returns to the “Compose Non-Distress” screen.
4. Select “Category,” and then push [ENT] or [CH/ENT].
  - The “Category” screen is displayed.
5. Select a category of the call, and the push [ENT] or [CH/ENT].
  - The category is set, and returns to the “Compose Non-Distress” screen.
6. Select “Channel,” and then push [ENT] or [CH/ENT].
7. Select the channel to assign, and then push [ENT] or [CH/ENT].
  - ① The assigned channels are preset by default.
8. Push **Call** to send the All Ships call.
  - “Transmitting All Ships Call” is displayed, and then the assigned channel is automatically selected.
  - ① If Channel 70 is busy, the transceiver stands by until the channel becomes clear.
9. Hold down [PTT] to communicate.
10. Push **STBY** to finish the All Ships call.
  - “Terminate the procedure. Are you sure?” is displayed.
11. Push **OK** to return to the operating screen.
  - Returns to the operating screen.

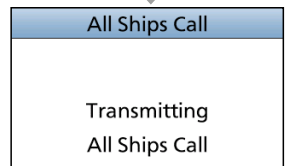
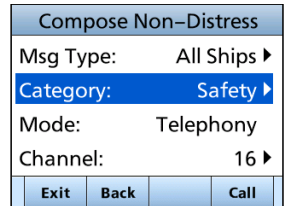
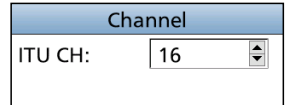
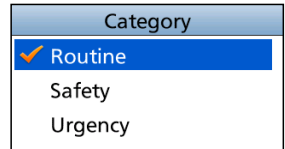
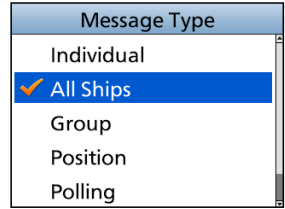

### ◇ Sending a Group call

A Group call enables you to send a DSC call to only a specific group.

① You can send a Group call to a pre-entered group address, or manually enter the address before sending. (p. 19)

1. Push **Other DSC**.
  - The “Compose Non-Distress” screen is displayed.
  - ① You can also display the “Compose Non-Distress” screen by selecting the “Other DSC” item on the Menu screen.
2. Select “Msg Type,” and then push [ENT] or [CH/ENT].
  - The “Message Type” screen is displayed.
3. Select “Group,” and then push [ENT] or [CH/ENT].
  - The Group call is selected, and returns to the “Compose Non-Distress” screen.
4. Select “Address,” and then push [ENT] or [CH/ENT].
  - The “Address” screen is displayed.
5. Select the group to send a Group call, and then push [ENT] or [CH/ENT].
  - ① You can also select “Manual Input” to manually enter the target group.
6. Select “Channel,” and then push [ENT].or [CH/ENT].
7. Select the channel to assign, and then push [ENT].
  - ① The assigned channels are preset by default.
8. Push **Call** to send the Group call.
  - “Transmitting Group Call” is displayed, and then the assigned channel is automatically selected.
  - ① If Channel 70 is busy, the transceiver stands by until the channel becomes clear.
9. Hold down [PTT] to communicate.

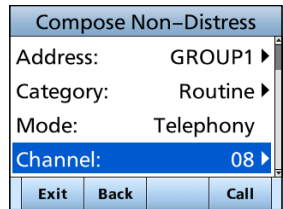
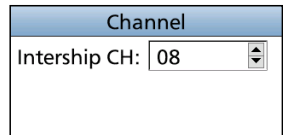
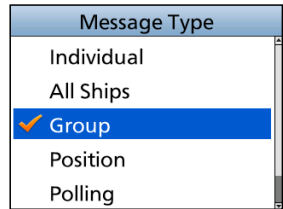

# 7 DIGITAL SELECTIVE CALLING (DSC)

## ◇ Sending a Test call

You should avoid testing calls on the exclusive DSC Distress channels and safety calling channels. When you cannot avoid testing on a Distress or safety channel, you should indicate that these are test calls.

Normally the Test call would require no further communications between the two stations involved.

1. Push **Other DSC**.
  - The “Compose Non-Distress” screen is displayed.
  - ① You can also display the “Compose Non-Distress” screen by selecting the “Other DSC” item on the Menu screen.
2. Select “Test,” and then push [ENT] or [CH/ENT].
  - The Test call is selected, and returns to the “Compose Non-Distress” screen.
3. Select “Address,” and then push [ENT] or [CH/ENT].
  - The “Address” screen is displayed.
4. Select a station to send the Test call to.
  - ① You can also select “Manual Input” to manually enter the calling station.
5. Push **Call** to send the Test call.
  - ① If Channel 70 is busy, the transceiver stands by until the channel becomes clear.
6. When you receive an Acknowledgment:
  - An alarm sounds.
  - The screen to the right is displayed.
7. Push **Alarm OFF** to turn OFF the alarm.
  - The Acknowledgment information is displayed.
8. Push **Close Window**.
  - The received call’s information is displayed.
  - The call is saved in the DSC Log.
9. Push **STBY** to return to the operating screen.
  - “Terminate the procedure. Are you sure?” is displayed.
10. Push **OK** to return to the operating screen.
  - Returns to the operating screen.

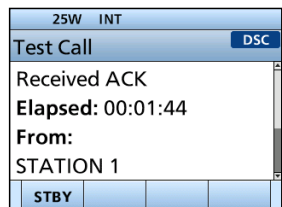
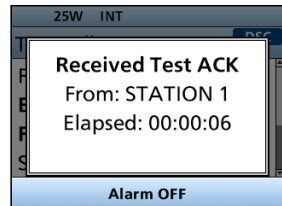
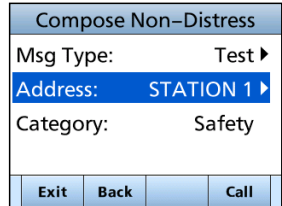
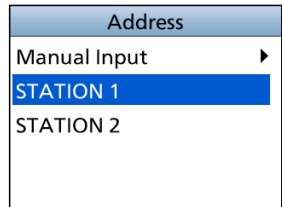
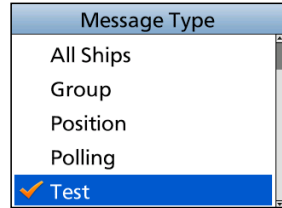

◇ **Sending a Test Acknowledgment**

By default, when you receive a Test call, the Auto ACK function automatically sends an Acknowledgment to the calling station (p. 46). If the function is set to “Manual,” do the following steps to send an Acknowledgment.

1. After a Test call is being received, push **Alarm OFF** to turn OFF the alarm.
2. Push **Accept**.
  - The received call's information is displayed.
3. Push **ACK**.
  - The “Test ACK” confirmation screen is displayed.
4. Push **Call** to send the Acknowledgment.
  - “Transmitting Test ACK” is displayed.
5. Push **STBY**, and then push **OK** to return to the operating screen.

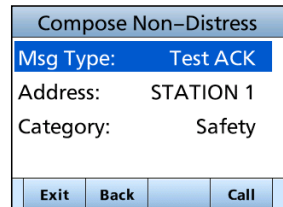
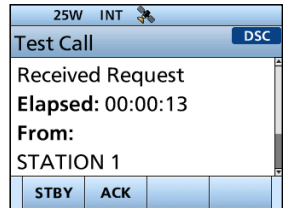
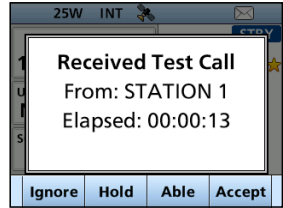

# 7 DIGITAL SELECTIVE CALLING (DSC)

## ◇ Sending a Position Request call/Polling Request call

You can send a Position Request call or Polling request call to a station, depending on the presetting.

- Send a Position Request call when you want to know a specific ship's current position.
- Send a Polling Request Call when you want to know a specific ship is in the communication area, or not.

### Example: Sending a Position Request call

1. Push **Other DSC**.
  - The "Compose Non-Distress" screen is displayed.
  - ① You can also display the "Compose Non-Distress" screen by selecting the "Other DSC" item on the Menu screen.
2. Select "Msg Type," and then push [ENT] or [CH/ENT].
3. Select "Position," and then push [ENT] or [CH/ENT].
  - ① When you send a Polling Request call, select "Polling."
  - The message type is selected, and returns to the "Compose Other" screen.
4. Select "Address," and then push [ENT] or [CH/ENT].
5. Select a target to send a Position Request call to, and then push [ENT] or [CH/ENT].
  - ① You can also select "Manual Input" to manually enter the target ID.
6. Push **Call** to send the Position Request call.
  - Position Request call is sent, and then "Waiting for ACK" is displayed.
  - ① If Channel 70 is busy, the transceiver stands by until the channel becomes clear.
7. When you receive a Position Reply:
  - An alarm sounds.
  - The screen to the right is displayed.
8. Push **Alarm OFF** to turn OFF the alarm.
9. Push **Close Window**.
  - The received information is displayed.
10. Push [▲] or [▼], or rotate [CH/ENT] to scroll the screen, and then check the target's position.
11. Push **STBY**, and then **OK** to return to the operating screen.

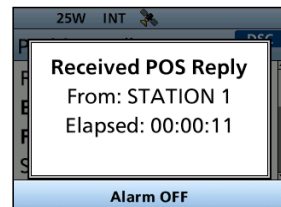
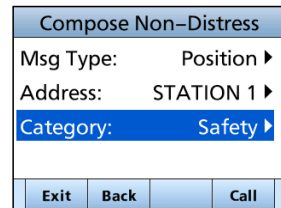
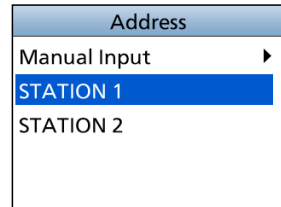



◇ Sending a Position Reply call

Send a Position Reply call when a Position Request call is received.

If the Auto ACK function is set to “Auto,” the Acknowledgment is automatically sent to the calling station. (p. 46)

1. After a Position Request is being received, push **Alarm OFF** to turn OFF the alarm.
  - The received call’s information is displayed.

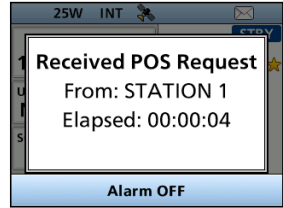

2. Push the Software Key below the intended operation.

**Ignore:** Ignores the call and returns to the operating screen.

- The call is saved in the DSC Log.
- “✉” blinks continuously until you display the call message.

**Hold:** Holds the RX call task, and returns to the Main screen.

**Able:** Sends Acknowledgment “Able to comply” right away.

- The call is saved in the DSC Log.
- Displays the Acknowledgment information, and then returns to the operating screen by pushing **STBY**, and then **OK**.

**Unable:** Sends an Acknowledgment “Unable to Comply.”

- The call is saved in the DSC Log.
- Displays the Acknowledgment information, and then returns to the operating screen by pushing **STBY**, and then **OK**.

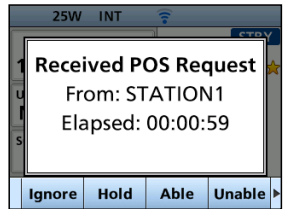

# 7 DIGITAL SELECTIVE CALLING (DSC)

## ◇ Sending a Position Reply call

- Accept** :
- Accepts the call.
  - Displays the received call's information.
  - The call is saved in the DSC Log.
- Push **ACK Able** or **ACK Unable**, then push **Call** to send the Position Reply call.
- STBY** : Closes the call, and then returns to the operating screen.
- ACK Able** : Sends an acknowledgment with position and time data.  
(Able to Comply)
- ACK Unable** : Sends an acknowledgment with no position and time data.  
(Unable to Comply)
- Push **STBY**, and then **OK** to return to the operating screen.

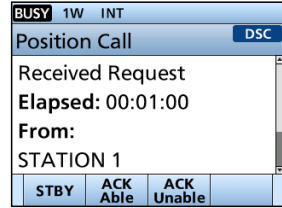

◇ **Sending a Polling Reply call/Position Report Reply call**

- Send a Polling Reply call when a Polling Request call is received.
  - ① When “Polling ACK” is set to “Auto,” the transceiver automatically sends the call.
- Send a Position Report Reply call when a Position Report call is received.

**Example: Sending a Polling Reply call**

1. While a Polling Request call is being received, push **Alarm OFF** to turn OFF the alarm.

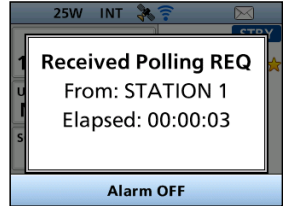

2. Push **Accept**.
  - Enters the DSC Task mode.

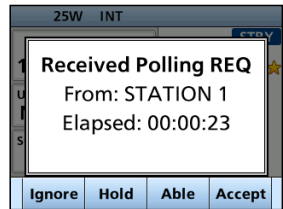

3. Push **ACK**.
  - The call contents screen is displayed.

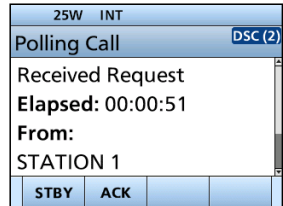

4. Push **Call** to send the Polling Reply.
  - “Transmitting Polling Reply” is displayed.
5. Push **STBY**, and then push **OK** to return to the operating screen.

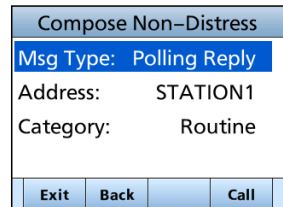

# 7 DIGITAL SELECTIVE CALLING (DSC)

## ■ Receiving DSC calls (Distress)

The transceiver receives Distress calls, Distress Acknowledgments, and Distress Cancel calls. When you receive a call, an emergency alarm sounds.

**NOTE:** The screens that are displayed when a Distress call or an Acknowledgment is received slightly differ from one another. The following steps are described using an example of receiving a Distress call.

### When a Distress call is received:

- The emergency alarm sounds until you turn it OFF.
- “Received Distress” is displayed.

1. Push **Alarm OFF** to turn OFF the alarm.
2. Push the Software Key below the intended operation.

**Ignore:** Returns to the operating screen. The call is saved in the DSC Log. “✉” blinks continuously until you display the call message.

**Hold:** Holds the RX call task, and returns to the Main screen.

**Pause:** **Pause** is not displayed if the “CH Auto Switch” item is set to “Manual.” (p. 46) Pauses the countdown until the assigned channel is automatically selected. Select **Resume** to resume the countdown. The call is saved in the DSC Log.

**Accept:** Accepts the call. Channel 16 is automatically selected. Monitor Channel 16 as a coast station may require assistance. After Channel 16 is selected, select your next operation by pushing the Software Key below the following options.

**STBY:** Closes the Distress operation, and returns to the operating screen.

**History:** Displays the “Distress History” screen.

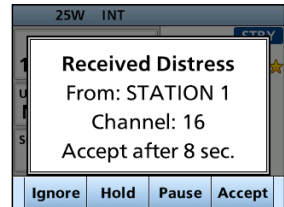
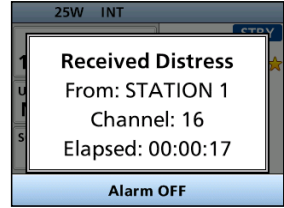

**When a Distress acknowledgment is received:**

1. After a Distress Acknowledgments is being received, push **Alarm OFF** to turn OFF the alarm.
  - The received information is displayed.
2. Push **Close Window**.
  - The received information is displayed.
3. Push **Accept**.
  - The received information is displayed.
4. Push **STBY**.
  - “Terminate the procedure. Are you sure?” is displayed.
5. Push **OK** to return to the operating screen.

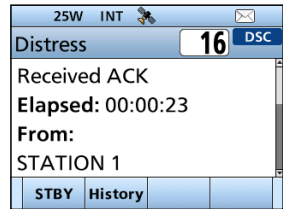
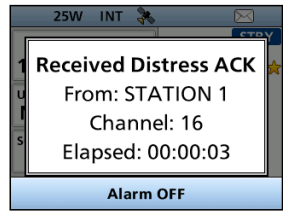

7

**When a Distress Cancel call is received:**

1. Push **Alarm OFF** to turn OFF the alarm.
  - The received information is displayed.
2. Push **STBY**, and then push **OK** to return to the operating screen.

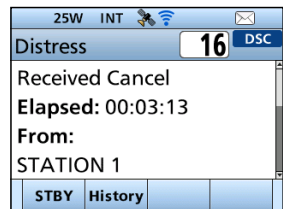
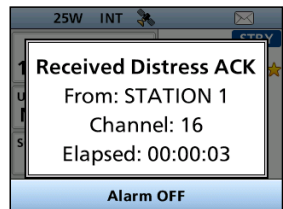

# 7 DIGITAL SELECTIVE CALLING (DSC)

## ◇ Receiving a Distress Relay call

### When a Distress Relay call is received:

- An alarm sounds.
- The following screen is displayed and the backlight blinks.
- “☒” blinks.

1. Push any **Alarm OFF**.



2. Push the Software Key below the next operation.

**Ignore**: Returns to the operating screen. The call is saved in the DSC Log. “☒” blinks continuously until you display the call message.

**Hold**: Holds the RX call task, and returns to the Main screen.

**Pause**: **Pause** is not displayed if the “CH Auto Switch” item is set to “Manual.” (p. 46) Pauses the countdown until the assigned channel is automatically selected. Select **Resume** to resume the countdown. The call is saved in the DSC Log.

**Accept**: Accepts the call. Channel 16 is automatically selected. Monitor Channel 16 as a coast station may require assistance. After Channel 16 is selected, select your next operation by pushing the Software Key below the following options.

**STBY**: Returns to the operating screen.

**History**: Displays the “Distress History” screen.

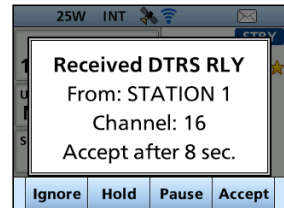

3. Push **STBY**, and then **OK** to return to the operating screen.

## ■ Receiving DSC calls (other)

The transceiver receives the following types of DSC calls.

- Individual call (p. 38)
  - Individual Acknowledgment (p. 26)
  - Group call / All Ships call (p. 39)
  - Position Request call (p. 40)
  - Test call / Position Report call (p. 41)
  - Test Acknowledgment / Position Reply call / Polling Reply call (p. 42)
- ① The receivable call types may differ, depending on the transceiver version or presetting.

By default, the Auto ACK function automatically sends an Acknowledgment to the calling station. ([MENU] > Settings > DSC > **Auto ACK** (p. 46))

If Auto ACK is set to “Manual,” you can manually send an Acknowledgment for each call as described in this section.

### ◇ Receiving an Individual call

#### When an Individual call is received:

- An alarm sounds.
  - “Received INDV Call” is displayed.
1. Push **Alarm OFF** to turn OFF the alarm.
  2. Push the Software Key below the next operation.
    - Ignore**: Ignores the call and returns to the operating screen.
      - The call is saved in the DSC Log.
      - “✉” blinks continuously until you display the call message.
    - Hold**: Holds the RX call task, and returns to the Main screen.
    - Able**: Sends an Individual Acknowledgment right away. (Able to comply)
      - Automatically switches to the assigned channel.
      - After sending, push **Resend** to resend.
      - The call is saved in the DSC Log.
    - Accept**: Accepts the call.
      - The call is saved in the DSC Log.
      - The received call’s information is displayed.
      - Push the Software Key to select the Acknowledgment option.

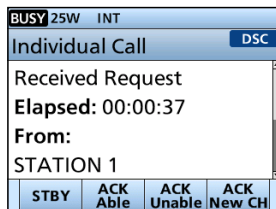
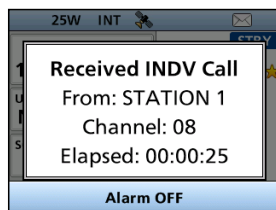

**STBY**: Push to delete the task and returns to the Main screen.

**ACK Able**: Sends an Acknowledgment without any changes. (Able to Comply)

**ACK Unable**: Sends an Acknowledgment but cannot communicate. (Unable to Comply)

**ACK New CH**: Able to communicate but proposes another channel. Specify the channel by pushing [▲] or [▼].

# 7 DIGITAL SELECTIVE CALLING (DSC)

## ◇ Receiving a Group call or All Ships call

### When a Group call is received:

- An alarm sounds.
- “Received Group Call” is displayed.

(Example: when a Group call is received)

### When an All Ships call is received:

- An alarm sounds.
- “Received All Ship Call” is displayed.

1. Push **Alarm OFF** to turn OFF the alarm.
  - The channel that is assigned by the caller is automatically selected after 10 seconds by default.
2. Push the Software Key below your next operation.

**Ignore:** Ignores the call and returns to the operating screen.

- The call is saved in the DSC Log.
- “✉” blinks continuously until you display the call message.

**Hold:** Holds the RX call task, and returns to the Main screen.

**Pause:** Pauses the countdown until the assigned channel is automatically selected.

- Select **Resume** to resume the countdown.
- The call is saved in the DSC Log.
- ① **Pause** is not displayed if the “CH Auto Switch” item is set to “Manual.” (p. 46)

**Accept:** Accepts the call.

- The assigned channel is selected.
- The call is saved in the DSC Log.

**STBY:** Closes the call, and then returns to the operating screen.

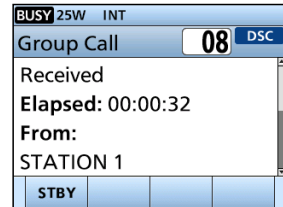



## ◇ Receiving a Position Request call

(May not be used, depending on the presetting)

**NOTE:** Even if the Auto ACK function is set to “Manual,” after receiving a Distress Acknowledgment, or while in the Distress Cancel call procedure, the Position Reply is automatically sent to the calling station.

### When a Position Request call is received:

- An alarm sounds.
- “Received POS Request” is displayed.

1. Push **Alarm OFF** to turn OFF the alarm.
  
2. Push the Software Key below the intended operation.

**Ignore:** Ignores the call and returns to the operating screen.

- The call is saved in the DSC Log.
- “✉” blinks continuously until you display the call message.

**Hold:** Holds the RX call task, and returns to the Main screen.

**Able:** Sends Acknowledgment “Able to comply” right away.  
(Able to comply)

**Unable:** Sends an Acknowledgment “Unable to Comply.”

- The call is saved in the DSC Log.
- Displays the Acknowledgment information, and then returns to the operating screen by pushing **STBY**, and then **OK**.

**Accept:** Accepts the call.

- Displays the received call’s information.
- The call is saved in the DSC Log.

Push **ACK Able** or **ACK Unable**, then push **Call** to send the Position Reply call. (p. 32)

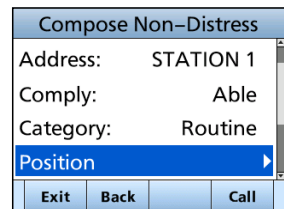
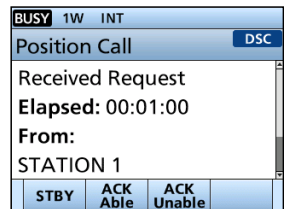
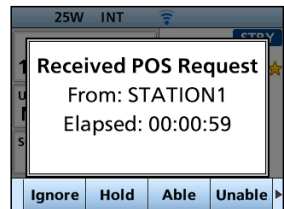

# 7 DIGITAL SELECTIVE CALLING (DSC)

## ◇ Receiving a Test call/Position Report call

### Example: Receiving a Test call

When a Test call is received:

- An alarm sounds.
- “Received Test Call” is displayed.

1. Push **Alarm OFF** to turn OFF the alarm.
  2. Push the Software Key below your next operation.
    - Ignore**: Ignores the call and returns to the operating screen.
      - The call is saved in the DSC Log.
      - “✉” blinks continuously until you display the call message.
    - Hold**: Holds the RX call task, and returns to the Main screen.
    - Able**: Sends a Test Acknowledgment “Able to Comply.”
      - The call is saved in the DSC Log.
    - Accept**: Accepts the call.
      - Displays the received call’s information.
      - The call is saved in the DSC Log.
      - The received call’s information is displayed.
- Push **ACK**, and then push **Call** to send a Test Acknowledgment. (p. 30)  
Push **Resend** to resend.

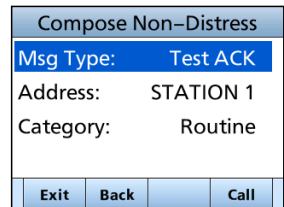
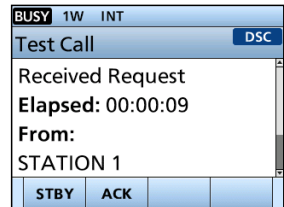

## ◇ Receiving a Test acknowledgment/Position Reply call /Polling Reply call

### Example: Receiving a Test acknowledgment

When a call is received:

- An alarm sounds.
  - The following screen is displayed and the backlight blinks.
  - "✉" blinks.
1. Push **Alarm OFF** to turn OFF the alarm.
  2. Push **Close Window**
    - The received information is displayed.
  3. Push **STBY**.
    - "Terminate the procedure. Are you sure?" is displayed.
  4. Push **OK** to return to the operating screen.

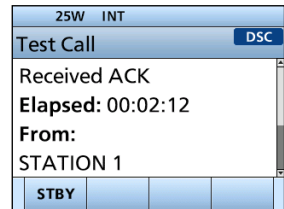
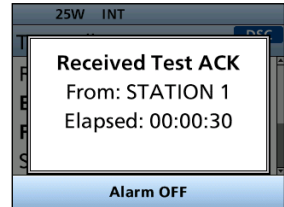

# 7 DIGITAL SELECTIVE CALLING (DSC)

## ■ DSC Log

### ◇ Received DSC Log

The transceiver saves up to 30 received Distress call messages and 50 received “Others” call messages in your DSC Log.

On the operating screen, “✉” is displayed when there is an unread call message. The icon blinks when there is a new received call message.

1. Open the “DSC Log” screen.

[MENU] > **DSC Log**

2. Select “Received Call Log,” and then push [ENT].
  - The “Received Call Log” screen is displayed.
3. Select “Distress” or “Others,” and then push [ENT].
  - ① “Distress” displays the received Distress call log, and “Others” displays the received DSC call log.

**TIP:** You can also display the “Received” screen by pushing **DSC Log** on the operating screen.

4. Select a log, and then push [ENT], [CH/ENT], or **INFO** to display the detailed information.

**INFO**: Displays the detailed information.

**Delete**: Deletes the selected call log.

**MMSI**: Saves the MMSI as an Individual ID.

Others (4)	
✉ 06:25	Polling REQ
✉ 11:55	All Ships
✉ 10:22	All Ships
✉ 10:22	Individual
Delete	INFO

Information	
All Ships Call	
<b>From:</b>	STATION 1
<b>Category:</b>	Routine
Delete	MMSI

### ◇ Transmitted DSC Log

The transceiver saves up to 30 DSC transmitted calls in your DSC Log.

1. Open the “DSC Log” screen.

[MENU] > **DSC Log**

2. Select “Transmitted Call Log,” and then push [ENT].
  - The “Transmitted Call Log” screen is displayed.
3. Select a log, and then push [ENT] to display the detailed information.

**INFO**: Displays the detailed information.

**Delete**: Deletes the selected call log.

**MMSI**: Saves the MMSI as an Individual ID or a Group ID.

## Multiple-task mode

If the Multiple-task function is enabled, the transceiver can hold up to 7 tasks. You can handle more than 2 DSC tasks simultaneously by switching between the tasks. To use the Multiple-task mode, select "Multiple" in the "Procedure" on the Menu screen. (p. 47)

[MENU] > Settings > DSC > **Procedure**

When the Multiple-task mode is activated, **Task List** is displayed on the operating screen.

**NOTE:** The Task mode has a Time-out Timer (TOT) function. After a certain period of time has passed without any operation on a task, the transceiver automatically deletes a task and returns to the operating screen.

When a Time-out Timer activates, an alarm sounds and a count down message is displayed for 10 seconds.

### ◇ Holding a DSC task

In the Multiple-task mode, you can hold or activate the DSC task as follows.

#### Example: When a Group call is received:

1. Push **Alarm OFF** to turn OFF the alarm.
  - The received call's information is displayed.
2. Push **Hold**.
  - The received Group call task is held into the task list and returns to the operating screen.



### ◇ Activating the held DSC task

1. Push **Task List** to display the task list.
  - The task list is displayed.
2. Select the task that you want to activate.
3. Push **Active** to activate the task.
  - The activated task information is displayed.
4. Push [PTT] to communicate.
5. After finishing the communication, push **Delete** to delete the task.



---

## 7 DIGITAL SELECTIVE CALLING (DSC)

### ◇ Task list

You can display the task list screen by pushing **Task List**.  
The number of tasks is displayed at the top of the screen.

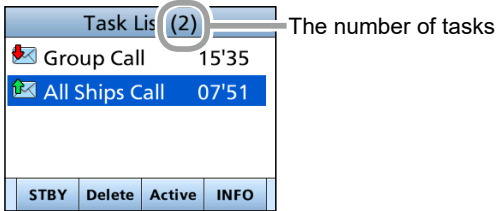

On the “Task List” screen, the following Software Keys are displayed.

- STBY**: Holds the task and returns to the operating screen.
- Delete**: Finishes the selected task.
- Active**: Activates the selected task.
- Hold**: Holds the selected task.
- INFO**: Displays the task information.

## ■ DSC Settings

On the “DSC” screen, you can make settings of the DSC call related items.

[MENU] > Settings > DSC

### Position Input

See “Entering the position and time” on page 20 for details.

### Individual ID

See “Entering an Individual ID” on page 19 for details.

### Group ID

See “Entering a Group ID” on page 19 for details.

### Auto ACK

The Auto ACK function automatically sends an Acknowledgment when an appropriate Request is received.

#### ● Individual ACK

Auto (Able): Automatically sends “Able to comply.”

Auto (Unable): Automatically sends “Unable to comply.”

Manual: Manually sends an Acknowledgment.

#### ● Position ACK

Auto (Able): Automatically sends “Able to comply.”

Manual: Manually sends an Acknowledgment.

#### ● Polling ACK

Auto: Automatically sends an Acknowledgment.

Manual: Manually sends an Acknowledgment.

#### ● Test ACK

Auto: Automatically sends an Acknowledgment.

Manual: Manually sends an Acknowledgment.

### CH Auto Switch

Select whether or not to automatically switch to channel 16 or the specified channel, or ignore the call.

Accept after 10 sec.:

After receiving a DSC call, the transceiver remains on the operating channel for 10 seconds. After that, the transceiver automatically switches to the channel that is specified on the DSC call.

Ignore after 10 sec.:

After receiving a DSC call, if you do not push the Software Key below **Accept** in 10 seconds, the transceiver ignores the call, and then remains on the current operating channel.

Manual:

After receiving a DSC call, you can select whether or not to accept the received DSC call.

**NOTE:** In the Multiple-task mode, “Ignore” is renamed to “Hold after 10 sec.”

### DSC Data Output

When receiving a DSC call from the station that is selected in this setting, the transceiver outputs the DSC data to the NMEA output port.

① You can send Distress calls despite of this setting.

All Stations: From any station.

Stations List: From the stations that are entered Individual ID or Group ID on the Menu screen.

OFF: Does not output any DSC data to an external device.

# 7 DIGITAL SELECTIVE CALLING (DSC)

## ■ DSC Settings

### Alarm Status

---

Sets the alarm ON or OFF when receiving each type of DSC call.

- **Safety**
- **Routine**
- **Warning**

Sets the alarm for when:

- No MMSI code is entered.
- The position data has not been received for 10 minutes after turning ON the transceiver.
- The received position data has not been updated for 10 minutes.
- The received position data has not been updated for 4 hours.
- The manually entered position data has not been updated for 23.5 hours.

- **Self-Terminate**

An alarm sounds when duplicate Distress calls are received.

- **Discrete**

An alarm sounds when a lower priority call is received while receiving a high priority call.

### CH 70 SQL Level

---

Sets the Squelch level for Channel 70 to 1 ~ 10 or Open.

### Self Check Test

---

The Self-Test sends DSC signals to the receiving AF circuit to compare the sending and receiving signals at the AF level.

Push [ENT] to start the Self-Test.

- ① When the sending and receiving DSC signals match, "OK" is displayed.

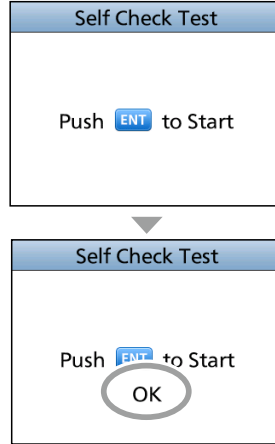

### Procedure

---

You can select the type of task for the transceiver, depending on the presetting.

Single: Handles only 1 task at the same time.

Multiple: Handles up to 7 tasks at the same time.



## ■ Making an Individual call to an AIS target

You can transmit an Individual call to a selected AIS target, without entering the target's MMSI code. In this case, the call type is automatically set to Routine.

### ◇ Selecting an AIS target on the IC-M510

You can compose an Individual call to an AIS target selected on the Plotter screen or the AIS list.

**NOTE:** The AIS information can be input to the transceiver through the NMEA0183 or NMEA2000 sentence source. Connect to an AIS receiver to receive the information.

1. Select the AIS target from the Plotter screen, the Target List, the Friends List, or the Danger list(pp. 55, 57).
2. Push **DSC**.
  - "Compose Non-Distress" screen is displayed.
3. Send an Individual call to an AIS target.
  - ① See page 25 for details.

7

### ◇ Using an AIS transponder

When the optional MA-510TR CLASS B AIS TRANSPONDER is connected to the IC-M510, you can transmit an Individual call to a selected AIS target and the voice channel on the transponder.

① See page 96 for connecting instructions.

**NOTE:** To ensure correct operation of the DSC function, make sure you correctly set the CH70 SQL Level. (p. 47)

① See the next page for the operation.

# 7 DIGITAL SELECTIVE CALLING (DSC)

## ■ Making an Individual call using an AIS transponder

### ◇ Using an AIS transponder

#### Transponder operation:

1. Select an AIS target on the plotter display, Target, Danger, or Friends list screen.
  - ① See the MA-510TR INSTRUCTION MANUAL for details.
2. Push [ENT] to display the Menu window.
  - The Menu window is displayed.
3. Select "Send DSC," and then push [ENT].
  - The "DSC TRANSMISSION" screen is displayed.

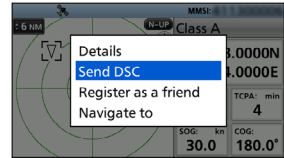

4. Push [▲] or [▼] to select a voice channel.
  - Voice channels are already preset into the transponder in the recommended order.

**NOTE:** When a base station is selected in step 1, a voice channel will be specified by the base station. Therefore you cannot change the channel. The transponder will display "Voice Channel is specified by the Base station," in this case.

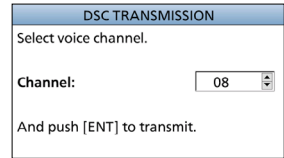

5. Push [ENT] to make the Individual DSC call.
  - "Transmitting individual call" is displayed.
  - ① If Channel 70 is busy, the transceiver stands by until the channel becomes clear.
6. After making the Individual DSC call, "DSC transmission completed." is displayed.
  - If the transceiver cannot make the call, "DSC transmission failed." is displayed.

#### Transceiver operation:

7. When the acknowledgment is received, alarm sounds.
  - If the acknowledgment 'Received ACK(Able)' is received, push **Alarm OFF** to stop the alarm, and then select the Intership channel specified in step 4.
    - A different Intership channel will be selected if the station you called cannot use the channel.
    - To reply, push [PTT] and speak at a normal voice level.
    - You can check the MMSI code or the name, if entered, of the AIS target on the display.
  - If the acknowledgment 'Received ACK(Unable)' is received, push **Alarm OFF** to stop the alarm, then the Acknowledge information is displayed.
8. After the communication is finished, push **STBY** to return to the normal operating mode.

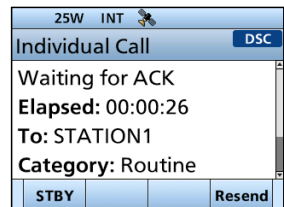

**NOTE:** The AIS information can be input to the transceiver through the NMEA0183 or NMEA2000 sentence source. Connect to an AIS receiver to receive the information.

## ■ About AIS

The Automatic Identification System (AIS) is primarily used for collision-risk management and navigation safety. It can automatically transmit and receive vessel information, such as the vessel name, MMSI code, vessel type, position data, speed, course, destination, and more, depending on the class. Information is exchanged among vessels and/or base stations on the VHF maritime mobile band. The information helps to identify other nearby vessels or stations by displaying the received data on a plotter or a radar screen.

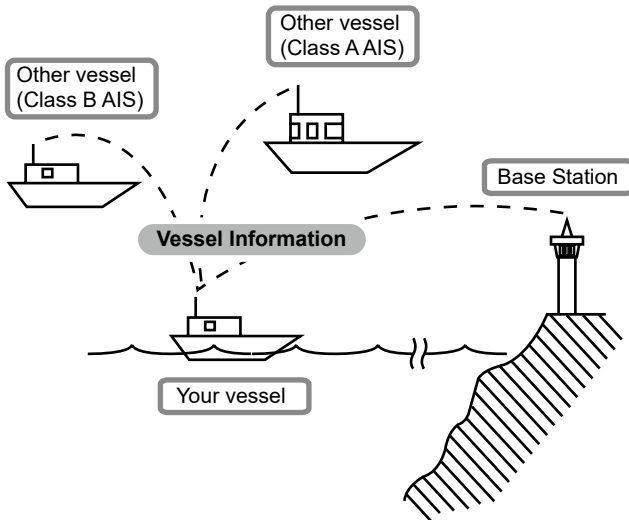

7

8

## ■ AIS classes

There are 7 types of AIS stations, vessels, base stations, Search and Rescue (SAR), Aids to Navigation (AtoN), Search and Rescue Transmitter (AIS-SART), Man OverBoard (MOB), and Emergency Position Indicating Radio Beacon-AIS (EPIRB-AIS).

There are 2 classes of AIS units, which are installed on vessels, Class A and Class B.

Under the Safety Of Life At Sea (SOLAS) convention, all SOLAS vessels, as described below, are required to install a Class A AIS transponder:

- Upwards of 300 gross tonnage engaged on international voyages.
- Passenger vessels, irrespective of size, engaged on international voyages.
- Upwards of 500 gross tonnage not engaged on international voyages.

A Class B AIS transponder is designed to be interoperability with Class A units, but not to impact the Class A network.

Many commercial vessels, and some leisure craft, not classified as requiring a Class A unit, choose to install a Class B unit to avoid accidents at sea.

## 8 AIS FUNCTION

### ■ Using the Plotter screen

On the plotter screen, the display range and the icons of the AIS target, waypoint for navigation and MOB are displayed. You can change the display range and type, depending on your operating style.

1. Push [DISP] and then select "Plotter".
  - The Plotter screen is displayed.
2. Push the Software Key for your next operation.

**Range:** Selects the display range. (p. 52)

**Target Select ◀:** Selects the closest target to your vessel.  
(Select ◀)

**Target Select ▶:** Selects the farthest target from your vessel.  
(Select ▶)

**Target Details:** Displays the details on the selected target. (p. 57)  
(Details)

**WPT:** Push to save your position information to the transceiver.

**NAV:** Push to start navigation.

**Stop NAV:** While navigating, push to stop navigation.

**MOB:** Push to enter the Man Overboard (MOB) mode. (p. 65)

**Stop MOB:** While in the Man Overboard (MOB) mode, push to stop the Man Overboard (MOB) mode.

**Anchor:** Push to start the Anchor watch function. (p. 66)

**Stop Anchor:** While in the Anchor watch mode, push to stop Anchor watch.

**NOTE:** An alarm sounds when an AIS target is closer than the CPA (Closest Point of Approach) and TCPA (Time to CPA) settings, and so on, depending on the presetting. To stop the alarm buzzer, push any key.

① If a popup screen is displayed, push any key again to turn it OFF.

**TIP:** You can display only the Plotter screen by selecting the "Plotter" item on the Menu screen.

[MENU] > AIS > **Plotter**

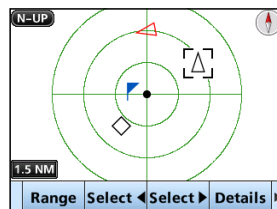
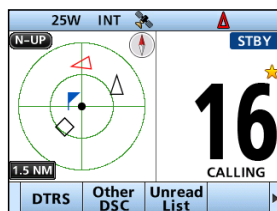

### ◇ Plotter screen

Displays the plotter display and selected target's information.

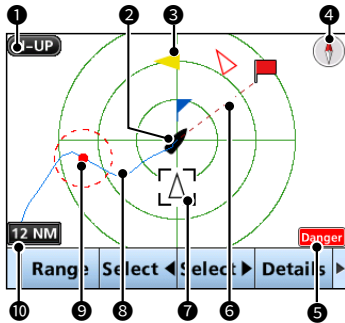

#### 1 DISPLAY TYPE

Displays the selected display type. You can select the display type in “North up/ Course up” on the Menu screen. (p. 59)

[MENU] > Settings > AIS > North up/Course up

- ① When “N-UP” is displayed, the top of the plotter screen represents North.
- ① When “C-UP” is displayed, the top of the plotter screen represents the direction your vessel’s course over ground.

#### 2 YOUR VESSEL ICON

Displayed in the center of the screen.

- ① When “N-UP” is displayed, the vessel icon automatically points in the direction your vessel is heading, in 5.625 degree steps.
- ① When “C-UP” is displayed, the vessel icon constantly points to the top of the plotter screen.
- ① When your vessel moves less than 2 knots, ● is displayed.

#### 3 TARGET ICONS

Targets whose AIS signal are received are displayed with icons. The icon may differ, depending on the target type or its status.

Icon	Description
	AIS target: Vessel ① The tip of the target triangle automatically points in the direction it's heading.
	AIS target: Vessel (Friend) (Yellow triangle)
	AIS target: AIS-SART, AIS-MOB, and EPIRB-AIS
	AIS target: Search and Rescue (SAR) vessel
	AIS target: Search and Rescue (SAR) aircraft
	AIS target: Aids to Navigation (AtoN)
	AIS target: Aids to Navigation (AtoN) virtual
	AIS target: Base station
	Waypoint ①  is displayed during navigation.
	MOB

- ① Icons for other than the SAR aircraft, Base station, Waypoint, and MOB are displayed in red or white while in the Night mode (pp. 12, 82), when the AIS target is closer than your CPA and TCPA settings (Danger target).
- ① A vessel is regarded as a “Lost target,” and a red cross mark displays on the target icon after a specified period of time has passed since the vessel last transmitted data (p. 71). The Lost target icon disappears from the plotter display 6 minutes and 40 seconds after the vessel was regarded as a “Lost target.” Ask your dealer for details.

#### 4 COMPASS

Displays the bearing information.

8



# 8 AIS FUNCTION

◇ Plotter screen

## 5 DISPLAY FILTER INDICATOR

Displayed when the type of targets on the plotter screen are filtered. (p. 59)

[MENU] > Settings > AIS  
> Target Display

Indicator	Description
	Only Danger AIS targets are displayed.
	Only Friend AIS targets are displayed.
	Only waypoints are displayed.
No indicator	All targets are displayed.

## 6 NAVIGATION LINE

Displays a line from the start position of navigation to the AIS target or waypoint.

## 7 TARGET BOX

Displays the selected target.

- ① When a target box is displayed, push  to display the detail screen of the selected target.

## 8 VESSEL TRACK

Displays your vessel track.

## 9 ANCHOR WATCH

- Displays  (a red circle) as the start position of anchor watch.
- Displays a red dashed circle as the range of anchor watch.

## 10 DISPLAY RANGE

- Displays the selected display range.
- Push  to select the desired display range.
  - ① 0.125, 0.25, 0.5, 0.75, 1.5, 3, 6, 12, 24, 36 NM (nautical miles) are selectable.

## ■ Using the AIS list screen

There are 3 types of AIS lists, Target, Danger, and Friends.

The target's information is automatically updated every 5 seconds, and then the AIS target data is sorted.

1. Push [MENU].
  - The Menu screen is displayed.
2. Push [▲], [▼], or rotate [CH/ENT] to select "AIS," and then push [ENT], [CH/ENT], or [▶].
  - The "AIS" screen is displayed.

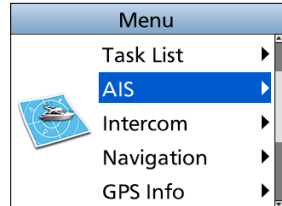

3. Push [▲] or [▼] to select a list, and then push [ENT], [CH/ENT], or [▶].
  - The list screen is displayed.
4. Push [▲], [▼], or rotate [CH/ENT] to select an AIS target.
5. Push the Software Key below for your next operation.

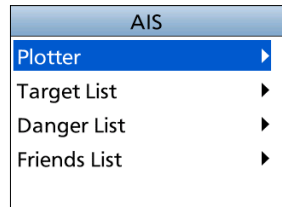

- DSC:** Displays the "Compose Non-Distress" screen to send an Individual call. (p. 25)  
 ① Displayed only when a target is selected.
- NAV:** Starts navigation to the selected target. (p. 67)  
 (Navigation)
- Friend:** Sets the selected target as a Friend. (p. 56)  
 ① Displayed only in the Target List or Danger List.
- Details:** Displays the details on the selected target. (p. 57)  
 ① Displayed only when the target is selected.
- Disp on Plotter:** Displays the selected target on the plotter screen. (p. 51)
- Sort:** Sorts the Danger target data by CPA or TCPA.  
 ① Displayed only in the Danger List.

**NOTE:** An alarm sounds when an AIS target is closer than the CPA and TCPA settings, and so on, depending on the presetting. To stop the alarm buzzer, push any key.

- ① If the popup screen is displayed, push any key again to turn it OFF.

# 8 AIS FUNCTION

## ◇ Target/Friends List screen

The Target List screen displays up to 200 AIS targets.

The Friends List screen displays the AIS targets of up to 100 targets that you set as a Friend. (p. 56)

The AIS target data is sorted by the distance from your vessel, and the closest target is located at the top of the list.

Target List ( 3 )			
Name/MMSI	RNG	BRG	
SAMPLE3	0.6	321	
SAMPLE2	1.7	029	
SAMPLE1	2.0	000	
DSC	NAV	Friend	Details ▶

Friends List ( 2 )			
Name/MMSI	RNG	BRG	
SAMPLE3	0.6	321	
SAMPLE1	2.0	000	
DSC	NAV	Details	Disp on Plotter ▶

- ① **THE NUMBER OF TARGETS**  
Displays the number of AIS targets.
- ② **TARGET INFORMATION**  
Displays the following AIS target information.
  - MMSI code or name
  - Range (RNG) from your vessel to the target (units: NM)
  - Bearing (BRG) from your vessel to the target (units: degree)

## ◇ Danger list screen

The Danger List screen displays any Danger target whose CPA (Closest Point of Approach) distance and TCPA (Time to CPA) time are less than the set values. You can set the values in “CPA” and “TCPA” on the Menu screen. (p. 59)

[MENU] > Settings > AIS > CPA/TCPA > CPA or TCPA

- ① The transceiver can display up to 200 targets.

Danger List ( 1 )			
Name/MMSI	CPA	TCPA	
SAMPLE1	0.8	1	
DSC	NAV	Friend	Details ▶

- ① **THE NUMBER OF TARGETS**  
Displays the number of AIS targets.
- ② **DANGER TARGET INFORMATION**  
Displays the following AIS target information.
  - MMSI code or name
  - CPA: Closest Point of Approach (unit: NM)
  - TCPA: Time to CPA (units: minute)



## ■ Setting a Friend

You can set up to 100 AIS targets as a Friend in the Friends List.

An alarm sounds when a Friend is detected, depending on the setting. (p. 60)

### ◇ Entering an ID

There are 3 ways of setting a Friend, using the Friends List, selecting in the AIS list, or selecting on the plotter display.

#### Using the Friends List:

1. Open the "Friends List" screen.

[MENU] > Settings > AIS > Friends > **Friends List**

- "No ID" is displayed when there is no Friend.
2. Push **Add** to display the Friend ID window.

#### TIP:

- Select a number using [**◀**] and [**▶**].
- Push [ENT], or [CH/ENT] to enter the selected number.
- Select "**←**" or "**→**" on the screen, or rotate [CH/ENT] to move the cursor.

3. Push **Finish** to save the edited ID.
  - The target is added to the Friends List.

#### Selecting in the Target List or Danger List:

1. Open a "Target List" or a "Danger List".

[MENU] > AIS > **Target List** or **Danger List**

2. Push [**▲**] or [**▼**], or rotate [CH/ENT] to select an AIS target.
3. Push **Friend**.
  - "Register as a Friend," is displayed.
  - ★ is displayed.

#### Selecting on the plotter display:

1. Open the plotter screen. (p. 51)
2. Push **Details** to display the details screen.
  - The "Details" screen is displayed.
3. Push **Friend**.
  - The target is added to the Friends List.
  - A friend target is displayed with ▲ (yellow triangle) on the plotter screen.

### ◇ Editing an ID

1. Open the "Friends List" screen.

[MENU] > Settings > AIS > Friends > **Friends List**

2. Push [**▲**] or [**▼**], or rotate [CH/ENT] to select an ID.
3. Push **Delete**.
  - ① See step 3 in "Using the Friends List," as described to the left.

### ◇ Deleting an ID

1. Open the "Friends List" screen.

[MENU] > Settings > AIS > Friends > **Friends List**

2. Push [**▲**] or [**▼**], or rotate [CH/ENT] to select an ID.
3. Push **Delete**.
  - "Delete the ID. Are you sure?" is displayed.
4. Push **OK**.

## ■ About the Detail screen

The Detail screen displays the information about the selected AIS target or waypoint. The contents may differ, depending on the selected target.

① When a Danger target is selected, ▲ is displayed. (p. 55)

① When a Friend target is selected, ☆ is displayed. (p. 55)

● Push the Software Key below for your next operation.

**DSC**: Displays the “Compose Non-Distress” screen to send an Individual call. (p. 25)

**NAV**: Starts navigation to the selected target. (p. 67)

**Friend**: Sets the selected target as a Friend. (p. 56)

① A beep sounds and a popup screen is displayed when the memory is full.

**MMSI**: Displays the Individual ID entry screen. (p. 8)

① A beep sounds and a popup screen is displayed when the memory is full, or the ID has been already added.

Detail		1/9 ▶
<b>Type:</b> Class A		
<b>MMSI:</b> 123456789		
<b>Call Sign:</b> ABCDEFG		
<b>IMO Number:</b> <span style="background-color: #cccccc;">XXXXXXXXXX</span>		
DSC	NAV	Friend MMSI

## ◇ Contents list

**NOTE:** The contents may differ, depending on the received data.

Class A and SAR vessel
AIS class
MMSI code
Ship name
Country name
Call sign
Vendor ID
IMO number
CPA (Closest Point of Approach)
TCPA (Time to CPA)
Position (Latitude, Longitude)
SOG (Speed Over Ground)
COG (Course Over Ground)
HDG (Heading)
PA (Position Accuracy (H: High, L: Low))
Range
Bearing
ROT (Rate Of Turn)
Bow to antenna distance
Stern to antenna distance
Port side to antenna distance
Starboard side to antenna distance
Length
Beam
Draught

Type of ship
NAV Status
Destination
Estimated time of arrival
Elapsed time

Class B
AIS class
MMSI code
Ship name
Country name
Call sign
Vendor ID
CPA (Closest Point of Approach)
TCPA (Time to CPA)
Position (Latitude, Longitude)
SOG (Speed Over Ground)
COG (Course Over Ground)
HDG (Heading)
PA (Position Accuracy (H: High, L: Low))
Range
Bearing
Bow to antenna distance
Stern to antenna distance
Port side to antenna distance

Starboard side to antenna distance
Length
Beam
Type of ship
Elapsed time

Bearing
Length
Width
Elapsed time

<b>AIS-SART, AIS-MOB, and EPIRB-AIS</b>
AIS class
MMSI code
CPA (Closest Point of Approach)
TCPA (Time to CPA)
Position (Latitude, Longitude)
SOG (Speed Over Ground)
COG (Course Over Ground)
HDG (Heading)
PA (Position Accuracy (H: High, L: Low))
Range
Bearing
ROT (Rate Of Turn)
Elapsed time

<b>AtoN and AtoN virtual</b>
AIS class
MMSI code
Target name
CPA (Closest Point of Approach)
TCPA (Time to CPA)
Position (Latitude, Longitude)
PA (Position Accuracy (H: High, L: Low))
Position indicator (ON POSN: ON Position, OFF POSN: OFF Position)
Range
Bearing
Bow to antenna length
Stern to antenna length
Port side to antenna length
Starboard side to antenna length
Length
Beam
Type of AtoN
Elapsed time

<b>Base station</b>
AIS class
MMSI code
Position (Latitude, Longitude)
PA (Position Accuracy (H: High, L: Low))
Vendor ID
Range
Bearing
Elapsed time

<b>Waypoint</b>
Name
Position (Latitude, Longitude)
Range
Bearing

<b>SAR aircraft</b>
AIS class
MMSI code
Target name
Country name
Call sign
Vendor ID
Position (Latitude, Longitude)
SOG (Speed Over Ground)
COG (Course Over Ground)
ALT (Altitude)
PA (Position Accuracy (H: High, L: Low))
Range

<b>MOB</b>
Position (Latitude, Longitude)
Range
Bearing

---

## 8 AIS FUNCTION

### ■ AIS settings

AIS settings can be customized in “AIS” on the Menu screen.

[MENU] > Settings > AIS

---

#### North up/Course up

You can select the display type for the plotter screen.

North up: The top of the plotter screen represents North.

Course up: The top of the plotter screen represents the direction your vessel's course over ground.

---

#### Target Display

You can select whether or not to limit the AIS or waypoint targets that are displayed on the plotter display. You can easily see the plotter display.

① The indicator is displayed on the plotter display. (p. 56)

① The waypoint for navigation is displayed, regardless of this setting.

All targets: All targets are displayed.

Danger only: Only Danger AIS targets are displayed.

Friends only: Only Friend AIS targets are displayed.

Waypoint only: Only waypoints are displayed.

---

#### CPA/TCPA

##### ● Alarm

You can select whether or not to turn the following alarm functions ON or OFF.

ON: The alarm function is ON. An alarm sounds, and a popup screen is displayed.

① The alarm may not sound, depending on the “Audible Alarm” setting.

OFF: The alarm function is OFF.

##### • Approach

The alarm function for when a vessel's CPA is closer, and TCPA is less than the set value.

##### • Lost

The alarm function for when a danger target is regarded as a “Lost target.” (p. 71)

##### ● Audible Alarm

You can select whether or not to sound the following alarms.

ON: The alarm sounds.

OFF: The alarm does not sound.

##### • Approach

The alarm function for when a vessel's CPA is closer, and TCPA is less than the set value.

##### • Lost

The alarm function for when a danger target is regarded as a “Lost target.” (p. 71)

##### ● CPA

Set a CPA (Closest Point of Approach) value between 0.01 and 6.00 NM (in 0.01 NM steps) for the alarm function.

##### ● TCPA

Set a TCPA (Time to CPA) value between 1 and 60 minutes (in 1 minute steps) for the alarm function.

## CPA/TCPA

● **Slow Warn**

The GPS receiver calculated COG data of a vessel that is at anchor or drifting is unreliable, and therefore the CPA and TCPA data may not be calculated correctly. If a vessel is anchored in your alarm zone, the unreliable data can cause the collision alarm to sound many times, even if there is no real danger.

To prevent this, when the anchored vessel's SOG is less than this set value, the Slow Warn function assumes that vessel's COG is fixed towards your vessel and an alarm will sound.

• **Function**

Turn the Slow warn function ON or OFF.  
ON: The Slow warn function is turned ON.

OFF: The Slow warn function is turned OFF.

• **Speed**

Set a speed for the Slow warn function between 0.1 and 4.9 kn (in 0.1 kn steps).

**NOTE:** If other vessels at anchor or drifting come into your alarm zone, the Slow warn alarm will sound again. Only if the previous vessel disappears from the Danger list (p. 55), and then re-enters the list, can a new Slow warn or regular alarm sound, depending on the vessel's SOG, or CPA and TCPA. The Slow warn function operates in the same way if your vessel is at anchor and other vessels enter your alarm zone.

## Friends

● **Friends List**

Displays all Friend targets that you have entered.

① "No ID" is displayed when there is no Friend target.

① See page 56 for how to set a Friend.

● **Friends Alarm**• **Function**

You can select whether or not to turn the following alarm function ON or OFF when a vessel that is entered into the Friends List is detected.

ON: The alarm function is ON.

An alarm sounds, and a popup screen is displayed when a vessel that is entered into the Friends list is detected, regardless of the set range.

ON

(in range): The alarm function is ON when a vessel that has entered into the Friends list is detected in the set range.

OFF: The alarm function is OFF.

• **Audible Alarm**

You can select whether or not to sound the Friends alarm.

ON: The alarm sounds.

OFF: The alarm does not sound.

• **Range**

Set the range to between 0.1 and 6.0 NM (in 0.1 NM steps) for the alarm function.

# 8 AIS FUNCTION

## ■ AIS settings

### ID Blocking

The transceiver blocks AIS transponders that are entered into the ID Blocking list. Enter your vessel's transponder ID or other vessel's transponder IDs if necessary to prevent the transceiver from detecting them as dangerous targets.

① You can enter up to 10 MMSI codes.

#### • Entering an ID

1. Open the "ID blocking" screen.

[MENU] > Settings > AIS >  
**ID Blocking**

- The blocked AIS transponder's ID is displayed.
  - "No ID" is displayed if there is no blocked AIS transponder.
2. Push **Add** to start the ID entry.
  3. Enter an ID.

#### TIP:

- Select a number using [**◀**] and [**▶**].
- Push [ENT] or [CH/ENT] to enter the selected number.
- Select "**←**" or "**→**," or rotate [CH/ENT] to move the cursor.

4. Select "**Finish**," and then push [ENT] to enter the ID.

#### • Editing an ID

1. Open the "ID Blocking" screen.

[MENU] > Settings > AIS >  
**ID Blocking**

2. Push [**▲**] or [**▼**] to select an ID.
3. Push **Edit**.
  - See step 3 in "Entering an ID," as described above.
4. Push **OK**.

#### • Deleting an ID

1. Open the "ID Blocking" screen.

[MENU] > Settings > AIS >  
**ID Blocking**

2. Push [**▲**] or [**▼**] to select an ID.
3. Push **Edit**.
  - "Delete the ID. Are you sure?" is displayed.
4. Push **OK**.

**NOTE:** For the other functions, the transceiver must be receiving valid GPS signals, or your position must be entered. (p. 20)

## Waypoint

Waypoints are GPS position data points of places you want to go to, the position of your own vessel, or of a vessel you received a DSC call from. You can enter up to 100 Waypoints with names of up to 15 characters. You can enter your current position data, or add one as a destination or landmarks you often go to, for easy access.

### Using the Waypoint list screen

The transceiver saves up to 100 waypoints in the Waypoint list.

1. Open the “Waypoint” screen.

[MENU] > Navigation > **Waypoint**

① You can also add your current position as a waypoint by pushing **Add**.

2. Push [▲] or [▼], or rotate [CH/ENT] to select a waypoint.

Waypoint (2)			
Name	RNG	BRG	
WPT01	0.6	321	
WPT02	2.0	000	
Sort	Details	NAV	Add

8

9

3. Push the Software Key below for your next operation.

**Sort**: Sorts the waypoints by Name or Range.

**Details**: Displays the details on the selected waypoint.

① You can also edit or delete the waypoint, or start navigating to the waypoint on the “Detail” screen.

**NAV**: Starts navigating to the selected waypoint. (p. 64)

**Add**: Enters a waypoint. (p. 63)

**Edit**: Edits the selected waypoint. (p. 64)

**Delete**: Deletes the selected waypoint. (p. 64)

Detail			
1/2 ▶			
<b>Name:</b>			
WPT01			
<b>LAT:</b> 34°37.3878N			
<b>LON:</b> 135°34.2921E			
Edit	Delete	NAV	

The details screen

## 9 OTHER FUNCTIONS

### ◇ Entering a waypoint

Position information that you want to memorize can be added as a waypoint.

**NOTE:** You can also add your current position as a waypoint by pushing **[WPT]**.

1. Open the “Waypoint” screen.

[MENU] > Navigation > **Waypoint**

2. Push **[Add]** to add a waypoint.
3. Enter a name.
  - The “Name:” screen is displayed.

#### TIP:

- Select **[A1]** to enter numbers and letters, and **[!\$?]** to enter symbols.
- Select a number, character, or space using **[▲]**, **[▼]**, **[◀]**, and **[▶]**.
- Push **[ENT]** or **[CH/ENT]** to enter the selected number or character.
- Select “←” or “→” on the screen, or rotate to move the cursor, or to select the entered character.

4. Repeat step 3 to enter the name of up to 15 characters.
5. Select **[Next]**, and then push **[ENT]** or **[CH/ENT]** to save the name.
  - The “LAT:” screen is displayed.
    - ① If you do not enter a name, a popup screen is displayed. Push any key to return to the previous screen.
6. Enter a latitude.
  - ① When GPS data is received, your current position information is automatically displayed.
7. Select **[Next]**, and then push **[ENT]** or **[CH/ENT]** to save the latitude.
  - The “LON:” screen is displayed.
    - ① If you enter a latitude that is out of the range, a popup screen is displayed. Push any key to return to the previous screen.
8. Enter a longitude.
  - ① When GPS data is received, your current position information is automatically displayed.
9. Select **[Finish]**, and then push **[ENT]** or **[CH/ENT]** to save the longitude.
  - The waypoint is saved, and the transponder returns to the previous screen.
    - ① If you enter a longitude that is out of range, a popup screen is displayed. Push any key to return to the dialog screen.

Waypoint (2)		
Name	RNG	BRG
WPT01	0.6	321
WPT02	2.0	000

Sort Details NAV Add ▶

Waypoint 6/15

Name:

WPT001

A	B	C	D	E	F	G	H	I	J	K	L	M
N	O	P	Q	R	S	T	U	V	W	X	Y	Z
0	1	2	3	4	5	6	7	8	9			

!\$? ← → Space Delete Next

Waypoint

LAT: [ ]° [ ]' [ ]" N

0	1	2	3	4	5	6	7	8	9
---	---	---	---	---	---	---	---	---	---

N S

← → Next

Waypoint

LON: [ ]° [ ]' [ ]" W

0	1	2	3	4	5	6	7	8	9
---	---	---	---	---	---	---	---	---	---

W E

← → Finish



## ◇ Editing a waypoint

A waypoint's name, latitude, longitude data can be edited.

① You cannot edit the waypoint that is being used for navigation.

1. Open the "Waypoint" screen.

[MENU] > Navigation > **Waypoint**

2. Push [▲] or [▼], or rotate [CH/ENT] to select a waypoint.

① Push to **Sort** sort the waypoints by Name or Range.

3. Select **Edit**.

① See steps 3 ~ 9 in "Entering a waypoint" on page 63.

## ◇ Deleting a waypoint

A waypoint can be deleted from the Waypoint list.

① You cannot delete the waypoint that is now being used for navigation.

1. Open the "Waypoint" screen.

[MENU] > Navigation > **Waypoint**

2. Push [▲] or [▼] or rotate [CH/ENT] to select a waypoint.

① Push to **Sort** sort the waypoints by Name or Range.

3. Push **Delete**.

• "Delete the Waypoint. Are you sure?" is displayed

4. Push **OK**.

• The selected waypoint is deleted, and the transceiver returns to the previous screen.

9

## ◇ Navigating to a waypoint

The transceiver assists you to navigate to a selected waypoint in the Waypoint list.

① See "Navigation" on page 67 for details.

1. Open the "Waypoint" screen.

[MENU] > Navigation > **Waypoint**

2. Push [▲] or [▼] or rotate [CH/ENT] to select a waypoint.

① Push **Sort** to sort the waypoints by Name or Range.

3. Push **NAV**.

• "Start navigation. Are you sure?" is displayed.

4. Push **OK**.

• The plotter screen is displayed, and the transceiver starts to navigate to the waypoint.

•  is displayed on the plotter screen.

① See step 4 in "Using **NAV**" on page 67.

**TIP:** You can also start navigation in the "Detail" screen of the waypoint.

1. Repeat steps 1 ~ 2.
2. Push **Details**, [ENT], or [CH/ENT].
  - The "Detail" screen is displayed.
3. Repeat steps 3 ~4.

## 9 OTHER FUNCTIONS

### ■ MOB (Man Overboard)

You can enter a Man OverBoard (MOB) waypoint into the transceiver with its GPS position data, as soon as a person has fallen into the water and needs to be rescued. This enables you to reach the MOB location even in the dark, or when you have lost visual contact.

You can select an AIS target during the MOB mode.

#### ◇ Starting MOB

- Push **MOB** to enter the MOB mode.
  - Three beeps sound.
  - The plotter screen is displayed, and  is displayed at your current position on the plotter screen.
- ① The Arrival and XTE alarms are not detected while in the MOB mode.

**TIP:** You can also start the MOB mode when you select the “Start MOB” item on the Menu screen.

[MENU] > Navigation > **Start MOB**

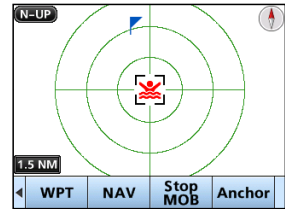

#### ◇ Stopping MOB

1. Push **Stop MOB** to stop the MOB mode, depending on the screen.
  - “Deactivate MOB. Are you sure?” is displayed.
2. Push **OK**.
  -  disappears, and the transceiver returns to the previous screen.

**TIP:** You can also stop the MOB mode by selecting the “Stop MOB” item on the Menu screen.

[MENU] > Navigation > **Stop MOB**

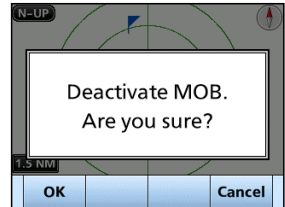

## ■ Anchor Watch

Anchor Watch is the function to sound an alarm when your vessel is at anchor and has drifted.

### ◇ Starting Anchor Watch

- Push **Anchor** to start the Anchor Watch mode.
  - **●** (a red circle) is displayed as the start position of anchor watch.
  - Displays a red dashed circle as the range of anchor watch.

**TIP:** You can also start the Anchor Watch mode when select the “Start Anchor Watch” item on the Menu screen.

[MENU] > Navigation > **Start Anchor Watch**

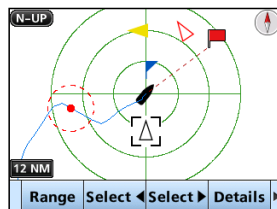

- ① When your vessel exceeds the range of the anchor watch, “Exceeded anchor radius!” is displayed.

9

### ◇ Stopping Anchor Watch

1. Push **Stop Anchor** to stop the Anchor Watch mode.
  - “Deactivate anchor watch. Are you sure?” is displayed.
2. Push [OK].
  - **●** (a red circle) and a red dashed circle disappear.

**TIP:** You can also stop the Anchor Watch mode by selecting the “Stop MOB” item on the Menu screen.

[MENU] > Navigation > **Stop Anchor Watch**

## 9 OTHER FUNCTIONS

### ■ Navigation

The transceiver assists you to navigate to a selected destination.

① The function works only when the transceiver is receiving valid GPS signals.

① The function cannot work while in the MOB mode.

**NOTE:** The Navigation function is a supplemental aid to navigation only, and is not intended to be a substitute for primary navigation equipment.

### ◇ Starting navigation

There are 3 ways of setting a destination using **[NAV]**, selecting in the AIS list, and selecting in the Waypoint list.

**NOTE:** A popup screen is displayed when the vessel arrives at or near the destination. To stop the function, push any key.

① When the Audible Alarm function is set to “ON,” an alarm also sounds. (p. 60)

#### Using **[NAV]**:

1. Push **[NAV]** on the operating screen.
  - The “Waypoint” screen is displayed.
2. Push **[▲]** or **[▼]**, or rotate **[CH/ENT]** to select a waypoint.
3. Push **[Start]** to start navigation.
  - The plotter screen is displayed, and the transceiver starts to navigate.
  -  is displayed on the plotter screen.
4. Push the Software Key for your next operation.

Waypoint (2)		
Name	RNG	BRG
WPT02	0.6	321
WPT01	1.7	029
Start	Sort	



#### Navigating to a waypoint:

See “Navigating to a waypoint” on page 64 for details.

**Selecting in the AIS list:**

1. Open the list screen.

[MENU] > AIS > **Target/Danger/Friend list**

2. Push [▲] or [▼] or rotate [CH/ENT] to select an AIS target.
3. Push **NAV**.
  - “Start navigation. Are you sure?” is displayed.
4. Push **OK** to start navigation.
  - The plotter screen is displayed, and the transceiver starts to navigate.
  -  is displayed on the plotter screen.

**TIP:** You can also start navigation in the details on the AIS target.

1. Repeat steps 1 ~ 2.
2. Push **Details**, [ENT], or [▶].
  - The “Details” screen is displayed.
3. Repeat steps 3 ~ 4.

**◇ Stopping navigation**

1. Push **Stop NAV** to stop navigation.
  - “Stop navigation. Are you sure?” is displayed.
2. Push **OK**.
  - The transceiver stops to navigate, and then returns to the previous screen.

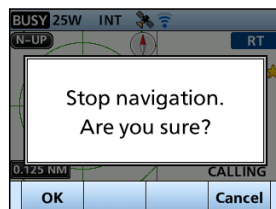
**◇ Resetting navigation**

The transceiver resets the start position, and restarts navigation from your current position.

- ① The function works only when the transceiver is receiving valid GPS signals.
- ① The function cannot work while in the MOB mode, or when the transceiver does not navigate.

1. Open the “Reset Navigation” screen.

[MENU] > Navigation > **Reset Navigation**

- “Reset navigation. Are you sure?” is displayed.
2. Push **OK**.
  - The transceiver resets the start position, and restarts navigation from your current position.



## 9 OTHER FUNCTIONS

### ◇ Highway screen

Displays the highway information (only for watching).

Push [DISP] several times to select Highway screen.

- ① "Navigation OFF" is displayed on the Highway screen when the Navigation mode is not used.

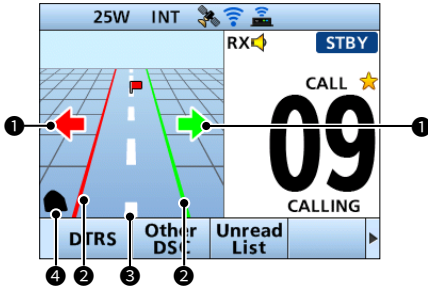

#### ① STEERING DIRECTION

Displayed when the vessel crosses the XTE (Cross Track Error) limit line.

#### ② XTE LIMIT LINE

Displays the limit line that marks when the vessel goes off course.

#### ③ NAVIGATION LINE

Displays a line from the start position of navigation to the AIS target or waypoint.

#### ④ YOUR VESSEL ICON

Displayed according to the destination's position.

- ① When your vessel moves less than 2 knots, ● is displayed.

## ◇ Navigation settings

Navigation settings can be customized in “Navigation” on the Menu screen.

[MENU] > Settings > **Navigation**

### Track

- **Display**  
You can select whether or not to display the vessel track on the plotter display.  
① The vessel track is recorded, regardless of this setting.  
ON: The vessel track is displayed.  
OFF: The vessel track is not displayed.
- **Record**  
You can select whether or not to save the vessel track.  
ON: The vessel track is saved.  
OFF: The vessel track is not saved.
- **Clear track**  
You can delete the vessel track.  
① When “Clear track. Are you sure?” is displayed, push **OK** to delete the vessel track.
- **Record Reference**  
You can select the setting to record the vessel track.  
Distance: The vessel track is recorded for a fixed distance.  
Time: The vessel track is recorded for a fixed period of time.
- **Interval (Distance)**  
Set the distance to record the vessel track to between 0.01 and 6.00 NM (in 0.01 NM steps), when you select “Distance” in the Record reference.
- **Interval (Time)**  
Set the period of time to record the vessel track to between 1 and 60 seconds (in 1 second steps) when you select “Time” in the Record reference.

### Anchor watch

- **Audible Alarm**  
You can select whether or not to sound an Arrival alarm when the vessel arrives at or near the destination.  
ON: The alarm sounds.  
OFF: The alarm does not sound.
- **Range**  
Set the range to between 0.01 and 6.00 NM (in 0.01 NM steps) for the alarm function.

### Arrival Alarm

- **Audible Alarm**  
Select whether or not to sound an arrival alarm.  
ON: The alarm sounds when the vessel arrives at or near the destination.  
OFF: The alarm does not sound.
- **Range**  
Set the range to sound an alarm when your vessel arrives at or near the destination to between 0.01 and 6.00 NM (in 0.01 NM steps).

### XTE alarm

- **Audible Alarm**  
Select whether or not to sound an XTE Alarm.  
ON: The alarm sounds when the vessel goes off course.  
OFF: The alarm does not sound.
- **Range**  
Set the range to sound an alarm when your vessel goes off course to between 0.01 and 6.00 NM (in 0.01 NM steps).

## 9 OTHER FUNCTIONS

### ■ Lost target

A vessel is regarded as a “Lost target” after a specified period of time has passed since the vessel last transmitted data, as described below.

The “Lost target” icon disappears from the plotter display 6 minutes and 40 seconds after the vessel was regarded as a “Lost target.” Ask your dealer for details.

#### The criteria to become a Lost target

##### • Class A/B

Vessel type		Lost target maximum interval Class A	Lost target maximum interval Class B *1	
			CS *2	SO*3
1	Class A: Vessel is at anchor, moored and not moving faster than 3 knots Class B: Vessel is not moving faster than 2 knots	1080 seconds	1080 seconds	
2	Vessel is at anchor, moored and moving faster than 3 knots	60 seconds	N/A	
3	Class A: Vessel is moving between 0 and 14 knots Class B: Vessel is moving between 2 and 14 knots	60 seconds	N/A	180 seconds
4	Class A: Vessel is moving between 0 and 14 knots while changing course Class B: Vessel is moving between 2 and 14 knots while changing course	60 seconds	N/A	
5	Vessel is moving between 14 and 23 knots	36 seconds	N/A	90 seconds
6	Vessel is moving between 14 and 23 knots while changing course	36 seconds	N/A	
7	Vessel is moving faster than 23 knots	30 seconds	N/A	30 seconds
8	Vessel is moving faster than 23 knots while changing course	30 seconds	N/A	
9	Vessel is moving faster than 2 knots	N/A	180 seconds	N/A

\*1 AIS Class B does not provide information about the navigational status, anchored or moored.

\*2 CS: Carrier-sense, \*3 SO: Self organized

##### • Others

Category	Lost target maximum interval
SAR aircraft	60 seconds
AtoN	1080 seconds
Base station	60 seconds



## ■ Using the Intercom

The optional Intercom function enables you to communicate between the deck and the cabin. The optional HM-195 COMMANDMICIV™, or Android/iOS device is required for Intercom operation.

- ① Connect the HM-195 as described on page 99.
- ① Download RS-M500 when you operate by the Android/iOS device.

- Transmitting is disabled while using the intercom.
- The received call audio is muted while using the intercom.

1. Open the “Intercom” screen.

[MENU] > **Intercom**

2. Select the unit, then push [ENT] or [CH/ENT].
  - Enters the Intercom mode.

3. Hold down **Call** to sound the intercom beeps.
  - The transceiver and the command microphone, or the mobile device sound beeps while holding down **Call**.
  - “Call” is displayed.

4. After releasing **Call**, hold down [PTT] and speak into the microphone at your normal voice level.
  - “Talk” is displayed.

- ① To adjust the transceiver volume level, rotate [VOL].

- ① To adjust the command microphone’s intercom volume level, rotate [VOL/SQL] (Dial) on the command microphone.

5. After releasing [PTT], you can hear the response through the speaker.
6. Push [CLEAR] to return to the previous screen.

**NOTE:** While in the Intercom mode, the transmit and receive functions are disabled. When the transceiver is transmitting, the Intercom function is disabled.

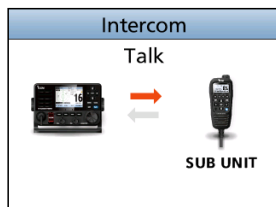
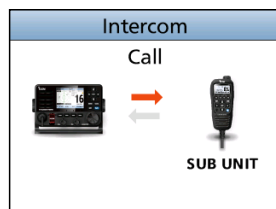
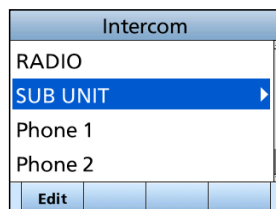

## 9 OTHER FUNCTIONS

### ■ Using the RX Hailer

The RX Hailer function enables you to hear the received audio on the deck or bridge through a Hailer speaker. To use this function, the external hailer speaker must be connected to the CT-M500, and the CT-M500 must be connected to the IC-M510.

- ① See page 88 for details of the connection to the CT-M500.
- ① Connect an external hailer speaker as described on CT-M500 Instruction Manual.

1. Push **Rx Hailer** to enter the RX Hailer mode.
2. Push **[▼]**, then push **[◀]** or **[▶]** or rotate **[CH/ENT]** to set the RX Hailer function ON or OFF.

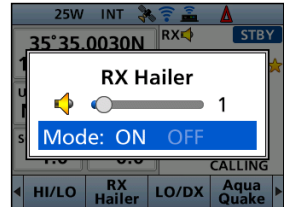

3. Push **[▲]**, then push **[◀]** or **[▶]** or rotate **[CH/ENT]** to adjust the volume level.

4. To exit the RX hailer mode, push **[ENT]** or **[CH/ENT]**.
  - The "RX" icon displayed when the RX hailer function is set to ON.



## ■ Using the Hailer

You can talk without leaving the bridge by using the 2 way hailer function.

To use this function, the external hailer speaker must be connected to the CT-M500, and the CT-M500 must be connected to the IC-M510.

- ① See page 88 for details of the connection to the CT-M500.
- ① Connect an external hailer speaker as described on CT-M500 Instruction Manual.
- You cannot transmit while using the hailer.

1. Open the “Hailer” screen.

[MENU] > **Hailer**

2. Hold down [PTT] and speak at your normal voice level.
3. While holding down [PTT], the screen shown to the right is displayed.



9

- ① Push **TX VOL** to open the volume adjustment screen.



**NOTE:** While in the hailer mode, the transmit and receive functions are disabled. When the transceiver is transmitting, the hailer function is disabled.



## 9 OTHER FUNCTIONS

### ■ Using the Horn function

#### ◇ Automatic Foghorn function

The Automatic Foghorn function sounds a horn repeatedly until the function is turned OFF.

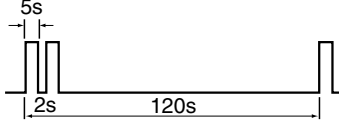
The foghorn outputs from the hailer speaker. To use this function, the hailer speaker must be connected to the CT-M500, and CT-M500 must be connected to the IC-M510. See page 88 for details of WLAN Settings and the CT-M500 Instruction Manual.

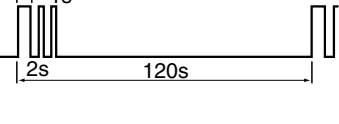
TYPE		PATTERN	USAGE
<b>Underway</b>	One 5-second blasts every 120 seconds.		Motor vessel underway and making way.
<b>Stop</b>	Two 5-second blasts (separated by 2 seconds) every 120 seconds.		Motor vessel underway but stopped (not making way).
<b>Sail</b>	One 5-second blast followed by two 1-second blasts (each separated by 2 seconds) every 120 seconds.		Sailing vessel underway, fishing vessel (underway or anchored), vessel not under command, a vessel restricted in her ability to maneuver (underway or at anchor), or a vessel towing or pushing another ahead.
<b>Tow</b>	One 5-second blast followed by three 1-second blasts (each separated by 2-seconds) every 120 seconds.		Vessel under tow (manned).

- Open the "Auto Foghorn" screen.  
 [MENU] > Horn > **Auto Foghorn**
- Select the foghorn pattern, and then push [ENT] or [CH/ENT] to return to the previous screen.
  - The "🔊" icon is displayed.
  - ① To turn OFF the Auto Foghorn, select "OFF" in the "Auto Foghorn" menu.

Auto Foghorn
OFF
✓ Underway
Stop
Sail
Tow

◇ **Horn Volume function**

1. Open the “Horn Volume” screen.  
 [MENU] > Horn > **Horn Volume**
2. Push [◀] or [▶], or rotate [CH/ENT] to adjust the foghorn level.

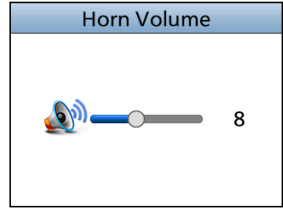

◇ **Manual Horn function**

1. Open the “Manual Horn” screen.  
 [MENU] > Horn > **Manual Horn**
2. Hold down [Horn] to sound a horn.
  - While holding down [Horn], the horn sounds, and the screen shown to the right is displayed.
  - ① To adjust the horn volume level, push [VOL] to open the Horn Volume popup screen.

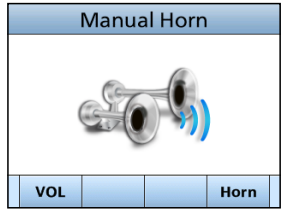

**NOTE:** While in the Horn mode, the transmit and receive functions are disabled. When the transceiver is transmitting, the Horn function is disabled.

◇ **Frequency setting**

1. Open the Frequency.  
 [MENU] > Horn > **Frequency**
2. Select the foghorn’s audio frequency.
  - ① Available frequency range is 200 Hz to 700 Hz in 50 Hz steps.

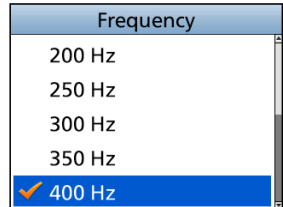

■ **Using the Voice Scrambler**

The Voice Scrambler provides private communications. In order to receive or send scrambled transmissions, you must activate the scrambler function. You also need to set the scrambler code on the Menu screen. (p. 84)

- ① The scrambler function automatically turns OFF when Channel 16 or 70 is selected.
1. Select an operating channel other than Channel 16, 70 or the weather channels.
  2. Push [Voice SBL] to turn the Voice Scrambler ON or OFF.
    - The “SBL” icon is displayed when the voice scrambler is ON.



◇ **Setting scrambler codes**

Set the code to between 1 and 32 on the Menu screen. In order to understand each other, all transceivers in your group must use the same scramble code.

## ■ Command microphone operation

You can connect an optional HM-195 COMMAND MICROPHONE to the transceiver. Push **DISP** to display the Plotter screen or the Highway screen on the command microphone screen.

### ◇ Plotter screen

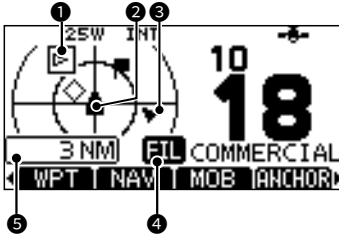

- 1 **TARGET BOX**
- 2 **YOUR VESSEL ICON**
  - ① The vessel icon automatically points in the direction your vessel is heading, in 45 degree steps.
  - ② When your vessel moves less than 2 knots per hour, ● is displayed.
- 3 **TARGET ICONS**

	AIS target: Vessel
	AIS target: Vessel (Friend)
	AIS target: AIS-SART, AIS-MOB, and EPIRB-AIS
	AIS target: Search and Rescue (SAR) aircraft
	AIS target: Aids to Navigation (AtoN)
	AIS target: Aids to Navigation (AtoN) virtual
	AIS target: Base station
	Waypoint: During navigation.
	MOB

\*Blinks when the AIS target is closer than your CPA and TCPA settings (Danger target).

- 4 **DISPLAY FILTER INDICATOR**  
Displayed when the type of targets on the plotter screen is filtered.
- 5 **DISPLAY RANGE**

### ◇ Highway screen

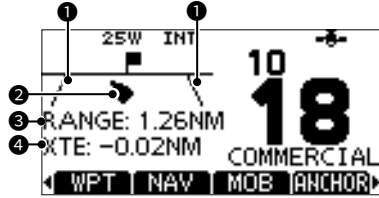

- 1 **XTE LIMIT LINE**
- 2 **YOUR VESSEL ICON**
  - ① When your vessel moves less than 2 knots per hour, ● is displayed.
- 3 **RANGE**  
Displays the range (RNG) from your vessel to the target.
- 4 **XTE**  
Displays the Cross Track Error.

### ◇ The Software Key names

Some Software Key names in the transceiver and the command microphone are different.

#### Example:

Transceiver	Command microphone
Target Select ◀	SEL ◀
Target Select ▶	SEL ▶
Dual Watch	DW
Tri Watch	TW
DSC Log	LOG
Target Details	INFO
Voice SBL	SCBL
RX Hailer	RX
AquaQuake	AQUA
FAV ★	★
CH Name	NAME
Back light	BKLT
Disp on Plotter	PLOT

## ◇ Command microphone Menu screen items

These items are displayed only on the Command microphone screen. Use the command microphone keys to make the settings.

### Display Contrast

[MENU] > Settings > Configuration > **Display Contrast**

Adjusts the contrast of the Command microphone's display in 8 steps. (Only in the Day Mode)

### Soft key/Dial assignment

[MENU] > Settings > Configuration > Key Assignment > **Soft key**

[MENU] > Settings > Configuration > Key Assignment > **Dial**

#### • Softkeys assignment

You can assign a desired function to a softkey. The assigned function can be used when its key icon is displayed on the Command microphone screen.

#### • Dial assignment

You can assign the audio volume (Volume), squelch (SQL), channel selection (Channel), and the Command microphone backlight level (Backlight) to any one of 4 sequential positions on the Dial. Pushing Dial 1 to 4 times sequentially selects the desired function, and rotating Dial adjusts the level, or selects a value or number.

#### Example: Dial assignment

1. Open the "Dial" screen.
2. Select the dial's position, then push [ENT].

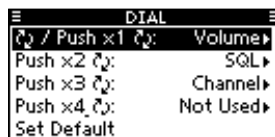

3. Select the item to assign, then push [ENT].

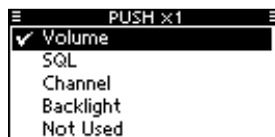

### COMMANDMIC Speaker

[MENU] > Settings > Configuration > **COMMANDMIC SP:**

Select the speaker to use when the Command microphone is connected to the transceiver.

Internal Speaker: The audio is heard from the transceiver's internal speaker.

External Speaker: The audio is heard from the Command microphone's external speaker.

**NOTE:** Regardless of this setting, the speaker of the microphone supplied with the transceiver is ON.

# 10 MENU SCREEN

## ■ Using the Menu screen

The Menu screen is used to set items, select options, and so on for the transceiver's functions.

### ◇ Menu screen operation

**Example:** Setting the key beep to "OFF."

1. Push [MENU].
  - The Menu screen is displayed.
2. Push [▲] or [▼], or rotate [CH/ENT] to select "Settings," and then push [ENT], [CH/ENT], or [▶].
  - The "Settings" screen is displayed.
  - ① Holding down [▲] or [▼], or rotate [CH/ENT] sequentially scrolls up or down through the Menu screen.
3. Push [▲] or [▼], or rotate [CH/ENT] to select "Configuration," and then push [ENT], [CH/ENT], or [▶].
  - The "Configuration" screen is displayed.
4. Push [▲] or [▼], or rotate [CH/ENT] to select "Key Beep," and then push [ENT], [CH/ENT], or [▶].
  - The "Key Beep" screen is displayed.
5. Push [▲] or [▼], or rotate [CH/ENT] to select "OFF," and then push [ENT] or [CH/ENT].
  - "OFF" is set and the transceiver returns to the previous screen.

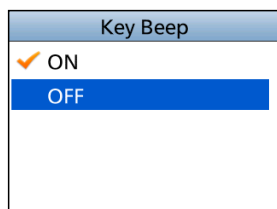
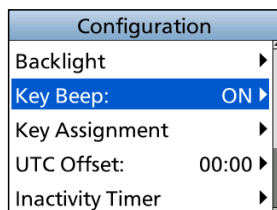
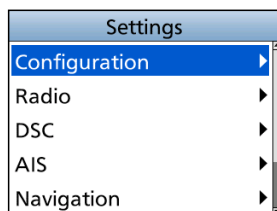
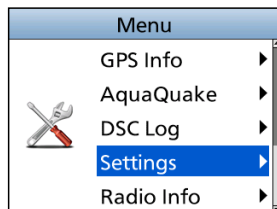

#### TIP:

- To exit the Menu screen, push [MENU].
- To return to the previous screen, push [◀] or [CLEAR].



◇ **Menu screen items**

The Menu screen contains the following items.

See the referred pages for each items.

The displayed menu items may differ, depending on the transceiver version or presetting.

Menu	Submenu	Item	Reference
Distress	–	Nature	p. 21
	Position	LAT	p. 20
		LON	
		UTC	
Other DSC	–	Msg Type	p. 25
		Address	
		Category	
		Mode	
	Channel	p. 20	
Unread List/Task List	–	–	p. 45
AIS	–	Plotter	p. 51
		Target List	p. 55
		Danger List	
		Friends List	
Hailer	–	–	p. 74
Horn	–	Manual Horn	p. 76
		Auto Foghorn	p. 75
		Horn Volume	p. 76
		Frequency	p. 76
Intercom	–	–	p. 72
Navigation	–	Waypoint	p. 62
		Stop Navigation	p. 68
		Reset Navigation	p. 68
		Start MOB/Stop MOB	p. 65
		Start Anchor Watch/ Stop Anchor Watch	p. 66
GPS Info	–	–	p. 82
AquaQuake	–	–	p. 14
DSC Log	–	Received Call Log	p. 43
		Transmitted Call Log	

# 10 MENU SCREEN

## ◇ Menu screen items

Menu	Submenu	Item	Reference
Settings	Configuration	Backlight	p. 82
		Display Contrast	p. 78
		Key Beep	p. 82
		Key Assignment	p. 82, 78
		UTC Offset	p. 82
		Inactivity Timer	p. 83
		GPS	
		COMMANDMIC SP	p. 78
		RX Hailer	p. 73
		Noise Cancel	p. 83
		PWR SW from MIC	
	Radio	Scan Type	p. 84
		Scan Timer	
		Dual/Tri-Watch	
		Channel Group	
		Call Channel	
		WX Alert	
		Voice Scrambler	
		Favorite CH	
		FAV on MIC	
		Channel Display	
		LO/DX	
	DSC	Position Input	p. 46
		Individual ID	
		Group ID	
		Auto ACK	
		CH Auto Switch	
		DSC Data Output	
		Alarm Status	p. 47
		CH 70 SQL Level	
		Self Check Test	
		Procedure	
AIS	North/Course Up	p. 59	
	Target Display		
	GPA/TCPA	p. 60	
	ID Blocking	p. 61	

Menu	Submenu	Item	Reference
Settings	Navigation	Track	p. 70
		Anchor Watch	
		Arrival Alarm	
		XTE Alarm	
	NMEA	NMEA 0183	p. 85
		NMEA 2000	
	WLAN	Function	p. 88
		Advanced Setting	
Information		p. 93	
Radio Info	–	–	p. 87

## ■ Menu items description

### ◇ GPS Info

Displays your position, date, time, Speed Over Ground (SOG), and Course Over Ground (COG).

### ◇ Settings

#### • Configuration

[MENU] > Settings > **Configuration**

#### Backlight

You can adjust the backlight brightness or the Display mode.

#### Key Beep

You can select whether or not to sound a beep when a key is pushed.

ON: Sounds a beep when a key is pushed.

OFF: No beep sounds, for silent operation.

### Key Assignment

#### ● Soft Key 1~16

You can change which Software Key functions to display, and their order. You can assign up to 16 Software Keys at a time.

① You cannot change “DTRS,” “Other DSC,” and “Unread List” Software Keys to other Software Key functions.

① The usable Software Key functions and their order may differ, depending on the transceiver version or presetting.

① Some Software Keys may not be usable, depending on other item settings.

#### ● Set Default

Sets the Software Key function order as default.

① The default setting may differ, depending on the transceiver version or presetting.

### UTC Offset

Set the offset time between Universal Time Coordinated (UTC) and your local time to between -14:00 and +14:00 (in 1 minute steps).

---

# 10 MENU SCREEN

## ■ Menu items description

### Inactivity Timer

---

The transceiver automatically returns to the operation screen if you push no key for the set period of time for each mode.

- **Not DSC Related**  
Setting for when a screen that is not related to DSC is displayed.
- **DSC Related**  
Setting for when a screen that is related to DSC is displayed.
- **Distress Related**  
Setting for when a screen that is related to a Distress call is displayed.
- **RT Related**  
Setting for when the transceiver is in the Radio Telephone mode.

### GPS

---

Selects a satellite to be used for GPS (Global Positioning System) to pinpoint the geographic location of your transceiver anywhere in the world.

This setting may not be usable, depending on the transceiver version or presetting.

- **GPS**  
The GPS (Global Positioning System) is permanently set to ON.
- **GLONASS**  
Selects whether or not to use the data from the GLONASS (GLObal'naya NAvigatsionnaya Sputnikovaya Sistema) satellites.
- **SBAS**  
Turns the SBAS (Satellite Based Augmentation System) function ON or OFF.  
When turning ON this function, the GPS position accuracy can be improved.

### RX Hailer

---

Set the RX Hailer function.

① See page 73 for details.

### Noise Cancel

---

The Noise Cancel function reduces random noise components in the received or transmitted signal. Set the function for both receiving and transmitting.

- **RX**
  - OFF: The Noise Cancel function is OFF.
  - Low: Reduces random noise components in the received signal to approximately one half.
  - Mid: Reduces random noise components in the received signal to approximately one third.
  - High: Reduces random noise components in the received signal to approximately one tenth.
- **TX**
  - ON: Reduces random noise components in the transmitted signal to approximately one third.
  - OFF: The Noise Cancel function is OFF.

### PWR SW from MIC

---

Select weather or not to turn OFF the transceiver at same time that you turn OFF the command microphone.

- ① The optional HM-195 COMMAND MICROPHONE is required to use this function.
- **All Units**  
When you turn OFF the command microphone, the transceiver is turned OFF at the same time.
- **Own Unit**  
The transceiver is not turned OFF even if you turn OFF the command microphone.

## • Radio

[MENU] > Settings > Radio

### Scan Type

Selects the scan type. The default setting differs, depending on the transceiver version.

① See page 16 for details.

**Normal Scan:** Scans all Favorite channels in the selected channel group.

**Priority Scan:** Sequentially scans all Favorite channels, while periodically checking Channel 16.

### Scan Timer

You can use the Scan Timer to pause, or to resume after 5 seconds, when a signal is detected.

**ON:** When a signal is detected on a channel, the scan pauses for 5 seconds, and then resumes. If the signal disappears in less than 5 seconds, the scan immediately resumes.

**OFF:** When a signal is detected on a channel, the scan pauses until the signal disappears, and then resumes.

### Dual/Tri-watch

Select Dualwatch or Tri-watch.

① See page 18 for details.

**Dualwatch:** Periodically checks Channel 16 while operating on another channel.

**Tri-watch:** Periodically checks Channel 16 and the Call channel while operating on another channel.

### Channel Group

Select the suitable channel group for your operating area. Select USA, INT, or CAN, depending on the transceiver version.

① See page 10 for details.

### Call Channel

You can change your Call channel. The default setting may differ, depending on the transceiver version.

① See page 13 for details.

### WX Alert

For the USA version, an NOAA broadcast station transmits a Weather Alert tone before any important weather information.

① See page 11 for details.

**ON with Scan:**

The preset Weather channels are sequentially checked while scanning.

**ON:** The previously selected (last used) Weather channel is checked while scanning.

**OFF:** The Weather Alert tone is not detected.

### Voice Scrambler

① Displayed only when a Voice scrambler unit is installed.

#### ● Function

Turn the Voice Scrambler function ON or OFF.

#### ● Codes

Set the Voice Scrambler code to between 1 and 32. In order to understand each other, all transceivers in your group must use the same scramble code, as well as the same scrambler unit.

### Favorite CH

You can set all channels as Favorite channels, clear all settings, or reset to default. By default, some channels are preset. The Favorite channels differ, depending on the transceiver version.

① See page 17 for details.

**Set All Channels:** Sets all channels as Favorite channels.

**Clear All Channels:** Clears all Favorite channels.

**Set Default:** Resets Favorite channels to the default.

---

# 10 MENU SCREEN

## ■ Menu items description

### **FAV on MIC**

---

Turn the FAV on MIC function ON or OFF.

ON: Pushing [▲] or [▼] on the supplied microphone scrolls up and down through only the Favorite channels.

OFF: Pushing [▲] or [▼] on the supplied microphone scrolls up and down through all channels.

### **Channel Display**

---

You can select the number of digits to display the channel number.

① This setting may not be usable, depending on the transceiver version or presetting.

3 digits: The channel number is displayed in 3 digits, such as "01A."

4 digits: The channel number is displayed in 4 digits, such as "1001."

### **LO/DX**

---

Push to turn the Attenuator function ON or OFF.

Local: The Attenuator function is ON.

Distance: The Attenuator function is OFF.

## • NMEA

[MENU] > Settings > **NMEA**

### **NMEA 0183**

---

Select the data transfer speed for each port to receive data from external devices.

4800 bps: Select to receive position data from an external GPS receiver.

38400 bps: Select to receive AIS data from an external AIS transponder.

### **NMEA 2000**

---

NMEA 2000 is a communication standard used to connect various marine devices and display units in the vessel.

The transceiver can easily connect to a NMEA 2000 network with its plug-and-play functionality, and display the information provided from the devices on the network. Select the sensors in NMEA 2000 network which sends data to the transceiver.

① See the next page for the compatible PGN list.

1. Open the "NMEA 2000" screen.
2. Select the type of data from the menu screen and push [ENT] or [CH/ENT].
3. The transceiver starts searching the devices connected to NMEA 2000 network.
  - ① Push **Stop Search** to stop searching devices and display the device list.
4. The list of connected device is displayed.
5. Select the device to send the data to the transceiver, and push [ENT] or [CH/ENT].
  - ① Push **INFO** to display the detail of device.
  - ① If the transceiver is connected to both NMEA 0183 and NMEA 2000 devices, the NMEA 2000 device has priority. Select "Not Used" if you want to use NMEA 0183 devices.

**Compatible PGN list**

<b>Receive</b>	
059392	ISO Acknowledgment
059904	ISO Request
060160	ISO Transport Protocol, Data Transfer
060416	ISO Transport Protocol, Connection Management
060928	ISO Address Claim
065240	ISO Commanded Address
126208	NMEA
126996	Product Information
129026	COG (Course Over Ground) and SOG (Speed Over Ground) - Rapid Update
129029	GNSS (Global Navigation Satellite System) Position Data
129038	AIS Class A Position Report
129039	AIS Class B Position Report
129040	AIS Class B Extended Position Report
129041	AIS Aids to Navigation (AtoN) Report
129793	AIS UTC and Date Report (Base Station)
129794	AIS Class A Static and Voyage Related Data
129798	AIS SAR Aircraft Position Report
129809	AIS Class B "CS" Static Data Report, Part A
129810	AIS Class B "CS" Static Data Report, Part B

<b>Transmit</b>	
059392	ISO Acknowledgment
059904	ISO Request
060416	ISO Transport Protocol, Connection Management
060928	ISO Address Claim
126208	NMEA - Acknowledge Group Function
126464	PGN List
126993	Heartbeat
126996	Product Information
126998	Configuration Information
129026	COG (course over ground) and SOG (speed over ground) - Rapid Update
129029	GNSS (Global Navigation Satellite System) Position Data
129038	AIS Class A Position Report
129039	AIS Class B Position Report
129040	AIS Class B Extended Position Report
129041	AIS Aids to Navigation (AtoN) Report
129539	GNSS DOPs
129540	GNSS Sats in View
129793	AIS UTC and Date Report (Base Station)
129794	AIS Class A Static and Voyage Related Data
129798	AIS SAR Aircraft Position Report
129799	Radio Frequency/Mode/Power
129808	DSC Call Information
129809	AIS Class B "CS" Static Data Report, Part A
129810	AIS Class B "CS" Static Data Report, Part B

---

# 10 MENU SCREEN

## ■ Menu items description

### ◇ Radio Info

[MENU] > **Radio Info**

Displays your transceiver's information, CT-M500's information, and command microphone's information as shown below.

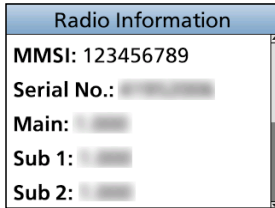



IC-M510 can expand the functions such as NMEA 2000, Hailer, and so on by connecting to the CT-M500 with WLAN.

IC-M510 can also be connected with mobile devices to communicate.

**NOTE:** Install the transceiver within approximately 15 meters (49.2 ft) meters from the CT-M500, and in a place where there are no obstacles between the transceiver and the CT-M500.

To expand the communication range, use a user supplied wireless access point.

## ■ Connecting to the IC-M510

When connecting to the CT-M500 or the RS-M500, select whether to use Access Point mode or Client mode.

① See the RS-M500 INSTALLATION MANUAL for details on connecting the mobile device to the transceiver.

### ◇ Access Point mode

CT-M500 and a mobile device can only connect to IC-M510's in the Access Point mode.

① A maximum of 4 mobile devices and a CT-M500 can be connected to the IC-M510.

① "TKIP/AES" method is automatically applied for the Access Point mode.

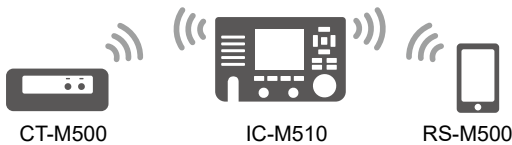

1. Open the "Function" screen.

[MENU] > Settings > WLAN > **Function**

2. Push [▲] or [▼], or rotate [CH/ENT] to select "ON," and then push [ENT] or [CH/ENT].
  - "ON" is set, and the transceiver returns to the previous screen.

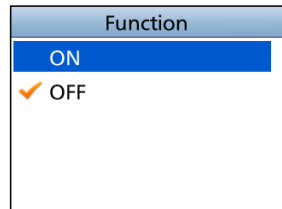

3. Push [▲] or [▼], or rotate [CH/ENT] to select "Advanced Settings," and then push [ENT], [CH/ENT], or [▶].
4. Select "Configuration" then push [ENT], [CH/ENT], or [▶].
5. Select "Access Point."
  - "Access Point Settings" screen is displayed.
  - ① When "Requires reconfigure the CT-M500/phone. Change setting and reset the CT-M500?" is displayed, Push **OK**.

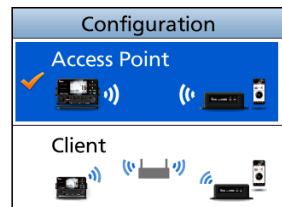

# 11 WLAN SETTING

## ◇ Access Point mode

6. Push [▲] or [▼], or rotate [CH/ENT] to select the set items and then push [ENT], [CH/ENT], or [▶].

**TIP:**

- Select **A1** to enter numbers and letters, and **IS?** to enter symbols.
- Select characters or space using [▲], [▼], [◀], and [▶].
- Push [ENT] or [CH/ENT] to enter the selected character.
- Select “←” or “→” on the screen, or rotate [CH/ENT] to move the cursor.

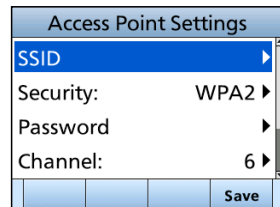
**Set items**

- SSID:** Enter the SSID.  
① Up to 32 characters can be entered.
- Security:** Select the authentication type.
- Password:** Enter an authentication password of 8 to 63 characters.  
① The entered password is masked like as "\*\*\*\*\*."
- Channel:** Set to specify the channel by pushing [▲] or [▼].
- IP Address:** Enter the IP address.
- Subnet Mask:** Enter the Subnet Mask (the range of the IP addresses used in the network). Enter the IP address and the Subnet Mask to be matched with the network that the CT-M500 or the mobile device connects to.

7. After setting the items, push **Save**, and return to the Advanced Settings screen.

8. Push [▲] or [▼], or rotate [CH/ENT] to select "CT-M500," and then push [ENT], [CH/ENT], or [▶].
  - "CT-M500" screen is displayed.
9. Select "WLAN Setup" then push [ENT], [CH/ENT], or [▶].
  - "WLAN will be temporarily disconnect during this operation.", or "This menu resets the CT-M500. Also, WLAN is temporarily disconnect." is displayed.

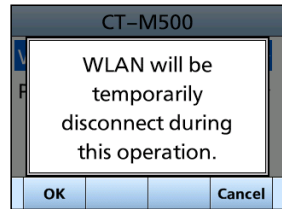
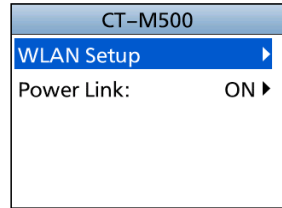

10. Push **OK**
  - The transceiver starts searching the devices connected to the CT-M500 network.
11. A list of CT-M500 is displayed.
  - ① If the CT-M500 you want to select is not found, wait for at least 30 seconds and then push [◀] or [CLEAR] to repeat step 9.

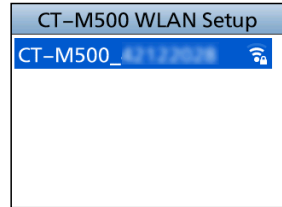

11

12. Select the device to send the data to the transceiver, and push [ENT] or [CH/ENT].
  - Started the CT-M500 WLAN setting up.

13. "Setup successful" is displayed when the CT-M500 and the transceiver are connected.
  - When the setup is successful,  is displayed

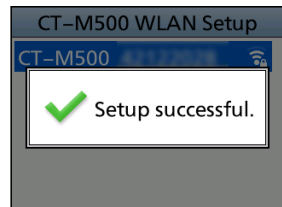

# 11 WLAN SETTING

## ◇ Client mode

CT-M500 and a mobile device can connect to IC-M510 by the user supplied access point.

① Set the CT-M500 in the “CT-M500 settings” of the IC-M510.

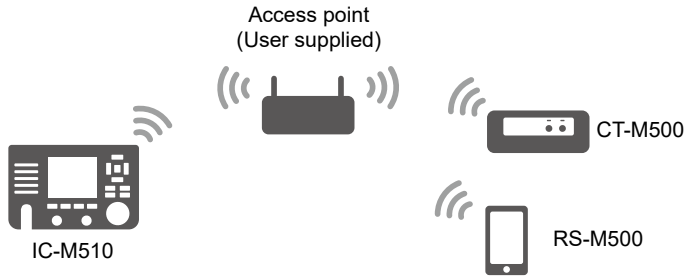

1. Open the “Configuration” screen.  
① See steps 1 ~ 4 on page 88.
2. Select “Client.”  
① When “Requires reconfigure the CT-M500/phone. Change setting?” is displayed, Push **OK**.
  - The transceiver starts searching the access point.

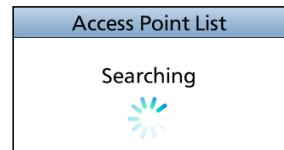

3. A list of the network device is displayed.
4. Push [**▲**] or [**▼**], or rotate [CH/ENT] to select the access point and then push [ENT], or [CH/ENT].

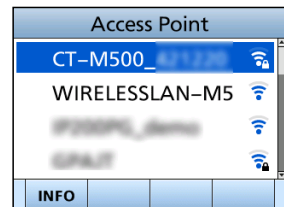

5. Select the Static IP address or the Global IP address according to your network environment.  
① When you select the “Manual,” enter the IP Address and the Subnet Mask.
6. If necessary, enter the SSID or the password, or select the Security type.  
① Enter the SSID up to 32 characters.  
① Enter an authentication password of 8 to 63 characters.
  - The transceiver starts connecting to the access point.

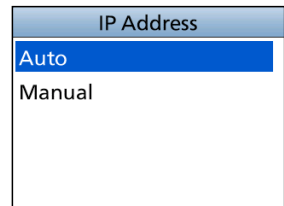

7. "Connection successful." is displayed when the transceiver and the access point are connected.
8. Connect the access point and the CT-M500.
  - ① See steps 8 ~ 13 on page 90.

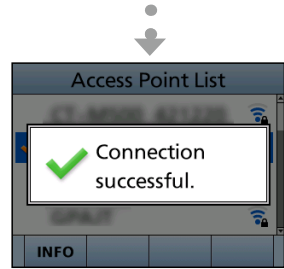

### NOTE: The default gateway settings

- When the DHCP server function of the access point is set to "Enable," enter the default gateway IP address.
- When you set your mobile device's IP address as the static IP address, set a default gateway IP address of the mobile device.

## ■ Power Link function

You can set whether the CT-M500 is automatically turned ON or OFF when the IC-M510 is turned ON or OFF.

- Open the "Power Link" screen.

[MENU] > Settings > WLAN > Advanced Settings > CT-M500 > **Power Link**

**ON:** The CT-M500 is linked so that when you turn ON the IC-M510, the CT-M500 also turns ON automatically.

**OFF:** The CT-M500 is not linked to the IC-M510.

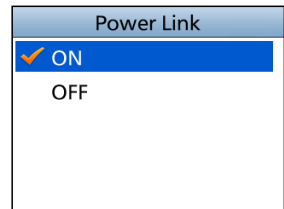

11

## ■ NMEA over WLAN settings

You can output the NMEA 0183 (ver. 2.0 or later) sentence through the Wireless LAN (WLAN).

[MENU] > Settings > WLAN > Advanced Settings > **NMEA over WLAN**

### Function

Select whether or not to connect to the NMEA 0183 network.

### Destination IP

Enter the destination IP address in the NMEA network.

### Destination Port

Enter the destination port number in the NMEA network.

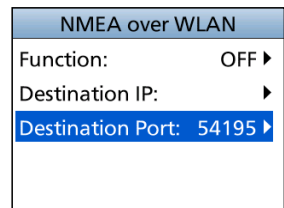

# 11 WLAN SETTING

## ■ Reset the WLAN settings

1. Open the “Advanced Settings” screen.  
[MENU] > Settings > WLAN > **Advanced Settings**
2. Select “Reset WLAN Settings” and then push [ENT], or [CH/ENT].
  - “Requires reconfigure the CT-M500/phone. Reset WLAN settings and the CT-M500?” is displayed.
3. Push **OK** to reset the CT-M500 WLAN Settings and the IC-M510 Advanced Settings.

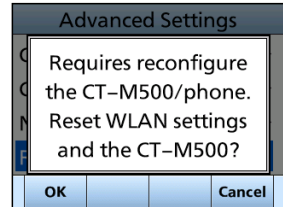

## ■ WLAN Information

You can confirm the network information for the transceiver and the CT-M500.

[MENU] > Settings > WLAN > **Information**

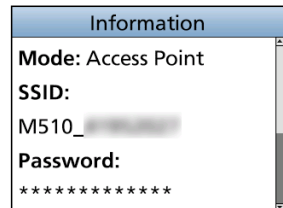

## ■ Supplied accessories

Mounting bracket

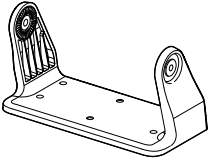

DC power cable

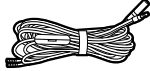

For mounting bracket

Knob bolts



Flat washers (M5)



Screws  
(5 × 20 mm)



Spring washers (M5)



Microphone

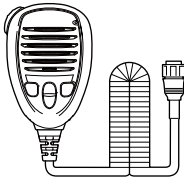

Microphone hanger  
and screws (3 × 16 mm)



Warning sticker



**NOTE:** Some accessories may not be supplied, or the shape may be different, depending on the transceiver version.

# 12 CONNECTIONS AND MAINTENANCE

## ■ Connections

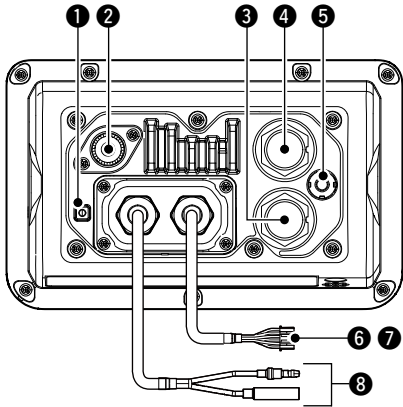

### 1 GROUND TERMINAL

Connects to a vessel ground to prevent electrical shocks and interference from other equipment occurring. Use a PH M3 × 6 screw (user supplied).

### 2 ANTENNA CONNECTOR

Connects to a marine VHF antenna with a PL-259 connector. A key element in the performance of any communication system is the antenna. Ask your dealer about antennas and the best place to mount them.

**CAUTION:** Transmitting without an antenna may damage the transceiver.

### 3 COMMAND MICROPHONE CONNECTOR

Connects the optional command microphone.

### 4 MICROPHONE CONNECTOR

Connects the supplied or optional microphone.\*

\* Not usable when the microphone is connected to the connector on the front panel.

### 5 GPS ANTENNA CONNECTOR

Connects to an optional GPS antenna.

#### NOTE:

- The GPS sentences input from this connector are given priority to over the sentences input from the built-in GPS receiver.
- Be sure the GPS antenna is positioned where it has a clear view to receive signals from satellites, and fixed using the supplied double-sided adhesive pad.

### 6 NMEA IN/OUT LEADS

Yellow: Listener A (Data-H), Data In (+)  
Green: Listener B (Data-L), Data In (-)  
Connect to the NMEA output lines of a GPS receiver for position data.

- NMEA 0183 (ver. 2.0 or later) sentence format RMC, GGA, GNS, or GLL and VTG compatible GPS receiver is required. Ask your dealer about suitable GPS receivers.
- The GPS sentences input from this connector are given priority to over the sentences input from the built-in GPS receiver.
- The AIS information through the AIS device inputs as VDM sentence.
  - ① The data communication speed (baud rate) is fixed at 38400 bps. Set the NMEA 0183 item to "38400 bps." (p. 85)

White: Talker A (Data-H), Data Out (+)  
Brown: Talker B (Data-L), Data Out (-)  
Connect to NMEA 0183 input lines of navigation equipment, to receive position data from other ships.

- An NMEA 0183 (ver. 2.0 or later) sentence format DSC or DSE compatible navigation equipment is required.
- The GPS outputs RMC, GSA, and GSV format sentences.
- The AIS information through the NMEA2000 device outputs as VDM sentences.



## 7 AF OUT LEADS

Connects to an external speaker.  
 Blue: External Speaker (+)  
 Black: External Speaker (-)

**NOTE for NMEA In/Out and AF Out leads:** The connectors are attached to keep the leads together. Before connecting to a piece of equipment, cut the leads to remove the connector.

## 8 DC POWER CONNECTOR

Connects to a 13.8 V DC power source.  
 (+: Red, -: Black)

**CAUTION:** After connecting the DC power cable, NMEA leads or external speaker leads, cover the connector and leads with a vulcanizing tape, as shown below, to prevent water seeping into the connection.

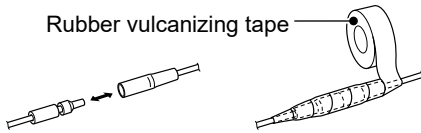

## ■ Cleaning

If the transceiver becomes dusty or dirty, wipe it clean with a soft cloth.



**DO NOT** use harsh solvents such as Benzine or alcohol, as they will damage the transceiver's surfaces.

## ■ Connecting to the MA-510TR

Connect the transceiver to the MA-510TR using the accessory cable. After connecting, an Individual DSC call can be made to the AIS target using the transponder without entering the target's MMSI code. (p. 19)

- ① See the instruction manual of MA-510TR's connecting instructions.
- Connect each lead to the appropriate lead as follows.
  - Listener A (Data-H) (Yellow): To NMEA IN (+)
  - Listener B (Data-L) (Green): To NMEA IN (-)
  - Talker A (Data-H) (White): To NMEA OUT (+)
  - Talker B (Data-L) (Brown): To NMEA OUT (-)

## ■ Fuse replacement

One fuse is installed in the supplied DC power cable. If the fuse blows or the transceiver stops functioning, track down the source of the problem, repair it, and replace the damaged fuse with a new one of the proper rating.

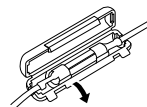
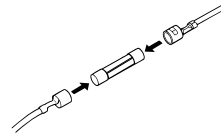
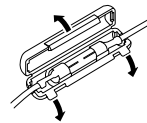

Fuse rating: 10 A

## 12 CONNECTIONS AND MAINTENANCE

### ■ Mounting the transceiver

#### ◇ Using the supplied mounting bracket

You can mount the transceiver on a dashboard using the universal mounting bracket supplied with your transceiver.

**CAUTION: KEEP** the transceiver and microphone at least 1 meter (3.3 ft) away from the vessel's magnetic navigation compass.

**NOTE:** The built-in GPS antenna is located, as shown to the right.

Be sure that the transceiver is positioned where the transceiver has a clear view to receive signal from satellites.

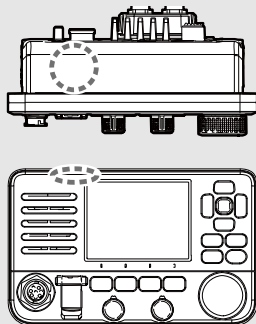

1. Mount the bracket securely to a surface which is more than 10 mm thick and can support more than 5 kg using the 4 supplied screws (5 × 20 mm).

**NOTE:** When mounting the transceiver on a board, fix the bracket to the board using the user supplied bolts and nuts, as shown below.

2. Attach the transceiver to the bracket so that the face of the transceiver is at 90° to your line of sight when operating it.  
① Adjust the function display angle to be easy-to-read.

#### Mounting Example

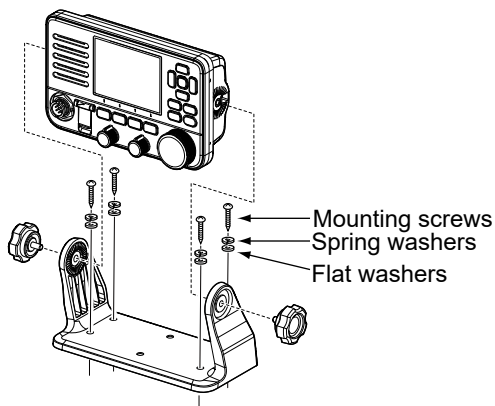

## ■ MBF-7 installation

The optional MBF-7 FLUSH MOUNT KIT is for mounting the transceiver to a flat surface (less than 20 mm thick), such as an instrument panel.

**NOTE:** Install the transceiver and/or microphone more than 1 meter from the vessel's magnetic navigation compass.

- Using the template on page 110, carefully cut a hole in the instrument panel, or wherever you plan to mount the transceiver.
- Slide the transceiver through the hole, as shown to the right.

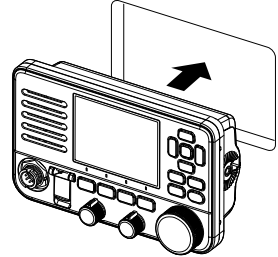

- Attach the 2 bolts (5 × 8 mm) and spacer supplied with the MBF-7 to both sides of the transceiver. (Torque: 2 N•m)

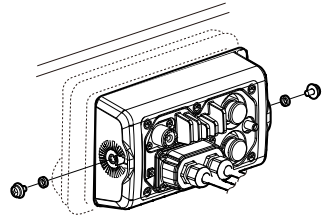

12

- Attach the clamps on both sides of the transceiver.
  - Make sure that the clamps align parallel to the transceiver body.

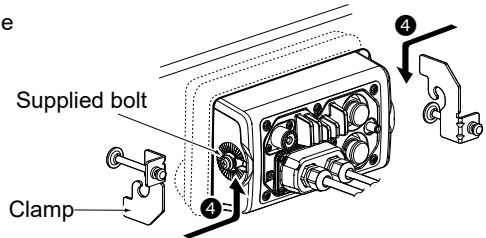

- Tighten the end bolts on the clamps (rotate clockwise) so that the clamps press firmly against the inside of the instrument control panel.

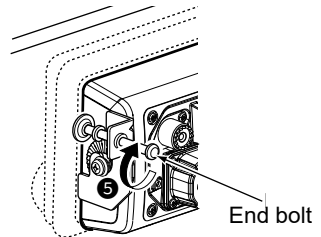

## 12 CONNECTIONS AND MAINTENANCE

### ■ MBF-7 installation

6. Tighten the locking nuts (rotate counterclockwise) so that the transceiver is securely mounted in position, as shown to the right. (Torque: 2 N·m)
7. Connect the antenna and power cable, and then return the instrument control panel to its original place.

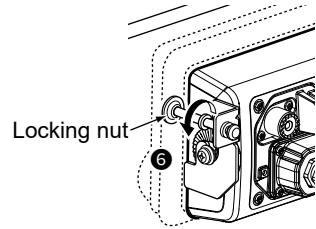

### ■ Microphone installation

To operate from even longer distances, the optional 6 meter long OPC-1541\* EXTENSION CABLE can be used between the transceiver and the OPC-1540 CONNECTION CABLE. Up to two OPC-1541 can be added.

\* For the HM-195.

You can also install the cable connector as a built-in plug on a cabinet or wall.

**NOTE:** The firmware of HM-195 may be update when you connect them to the transceiver.

### ◇ Installation

1. Insert the connection cable connector into the command microphone jack, and tighten the nut.
2. To use the cable connector as a wall socket, install it as shown below.
3. Using the mounting base as a template, carefully mark the holes where the cable and 3 screws will be fastened.
4. Drill holes at these marks.
5. Install the mounting base using the supplied screws, as shown below.

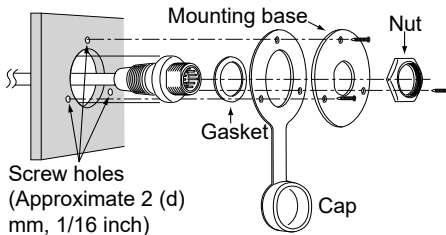

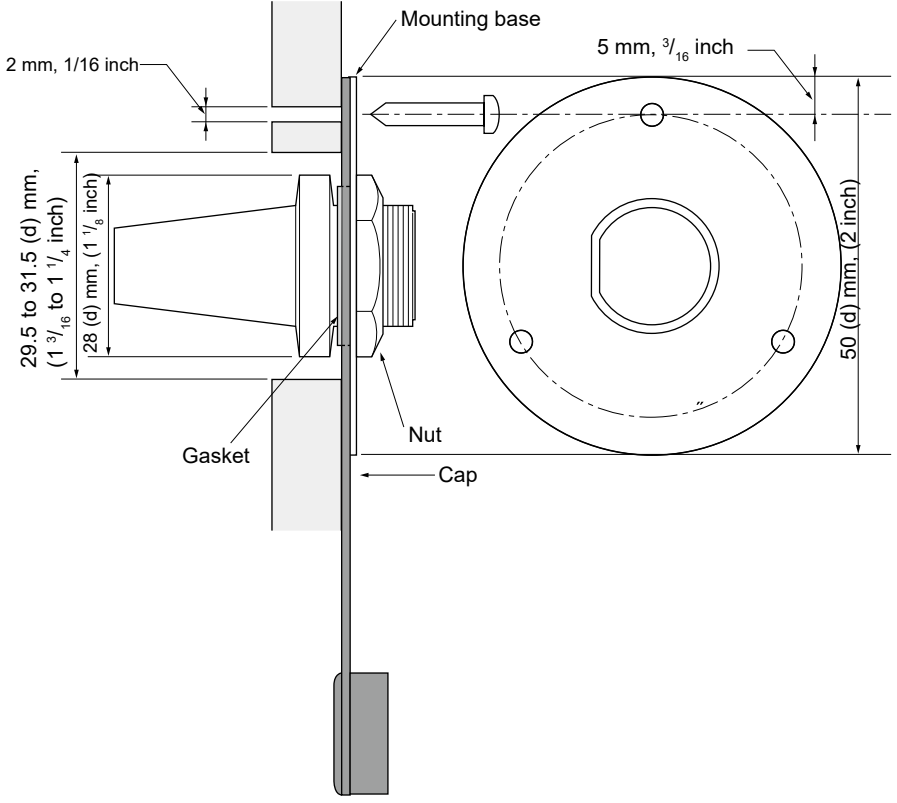

# 13 SPECIFICATIONS AND OPTIONS

## ■ Specifications

① All stated specifications are subject to change without notice or obligation.

① Measurements made without an antenna.

### ◇ General

- Frequency coverage: TX: 156.025 ~ 157.425 MHz  
RX: 156.050 ~ 163.275 MHz  
WX CH: 161.650 MHz to 163.275 MHz  
DSC (CH70): 156.525 MHz
- Mode: 16K0G3E (FM), 16K0G2B (DSC)
- Operating temperature range:  $-20^{\circ}\text{C} \sim +60^{\circ}\text{C}$ ,  $-4^{\circ}\text{F} \sim +140^{\circ}\text{F}$
- Current drain (at 13.8 V): TX high (25 W): 5.0 A maximum  
RX Maximum audio: 3.3 A maximum  
Negative ground: 13.8 V DC (11.7 ~ 15.9 V DC)
- Power supply requirement: 0.5 kHz
- Frequency tolerance: 50  $\Omega$  nominal
- Antenna impedance: 175 (W)  $\times$  110 (H)  $\times$  53.6 (D) mm  
6.9 (W)  $\times$  4.3 (H)  $\times$  2.1 (D) in
- Dimensions (approximate, projections not included): 730 g, 1.6 lb (Not including microphone)
- Weight (approximate):

### ◇ Transmitter

- Output power: 25 W or 1 W
- Modulation system: Variable reactance frequency modulation
- Maximum frequency deviation:  $\pm 5$  kHz
- Spurious emissions: Less than  $-70$  dBc (High Power)  
Less than  $-56$  dBc (Low Power)
- Adjacent channel power: More than 70 dB
- Audio harmonic distortion: Less than 10 % (at 60% Deviation)
- Residual modulation: More than 40 dB
- Audio frequency response:  $+1$  dB to  $-3$  dB of 6 dB octave from 300 Hz to 3000 Hz

## ◇ Receiver

- |  |   |
|--|---|
| <ul style="list-style-type: none"> <li>• Receive system:</li> <li>• Sensitivity:</li> <li>• Squelch sensitivity:</li> <li>• Intermodulation rejection ratio:</li> <li>• Spurious response:</li> <li>• Adjacent channel selectivity:</li> <li>• Audio output power<br/>(at 10% distortion into a 4 Ω<br/>External Speaker):</li> <li>• Hum and noise:</li> <li>• Audio frequency response:</li> </ul> | <p>Double conversion superheterodyne<br/>           FM: -10 dBμ at 12 dB SINAD<br/>           DSC (CH70): -1 dBμ emf (1% BER)<br/>           Less than -7 dBμ</p> <p>FM: More than 75 dB<br/>           DSC (CH70): More than 68 dBμ emf (1% BER)</p> <p>FM: More than 75 dB<br/>           DSC (CH70): More than 73 dBμ emf (1% BER)</p> <p>FM: More than 75 dB<br/>           DSC (CH70): More than 73 dBμ emf (1% BER)</p> <p>More than 15 W</p> <p>More than 40 dB<br/>           +1 to -3 dB of -6 dB/octave range from 300 Hz to<br/>           3000 Hz</p> |
|--|---|

## ◇ Built-in GPS

- |   |  |
|---|--|
| <ul style="list-style-type: none"> <li>• Channel:</li> <li>• Deferential satellites</li> <li>• Corresponding GNSS:</li> <li>• Receiving frequency:</li> </ul> | <p>Acquisition, tracking: Maximum 24 ch<br/>           Calculation: Maximum 12 ch<br/>           WAAS, EGNOS, MSAS, GAGAN<br/>           GPS, GLONASS, SBAS<br/>           GPS, SBAS: 1575.42 MHz<br/>           GLONASS: 1598.0625 MHz ~ 1605.375 MHz</p> |
|---|--|

## ◇ Wireless LAN

- |  |   |
|--|---|
| <ul style="list-style-type: none"> <li>• Wireless LAN standard</li> <li>• Authentication and Encryption</li> <li>• Channels</li> <li>• Output power</li> </ul> | <p>IEEE802.11 b/g/n<br/>           WEP (64/128 bit),<br/>           WPA-PSK (TKIP),<br/>           WPA2-PSK (AES)<br/>           1 to 13 (2.4 GHz band)<br/>           ⓘ May differ depending on the country of use.<br/>           Less than 10 mW/MHz</p> |
|--|---|

# 13 SPECIFICATIONS AND OPTIONS

## ◇ Dimensions

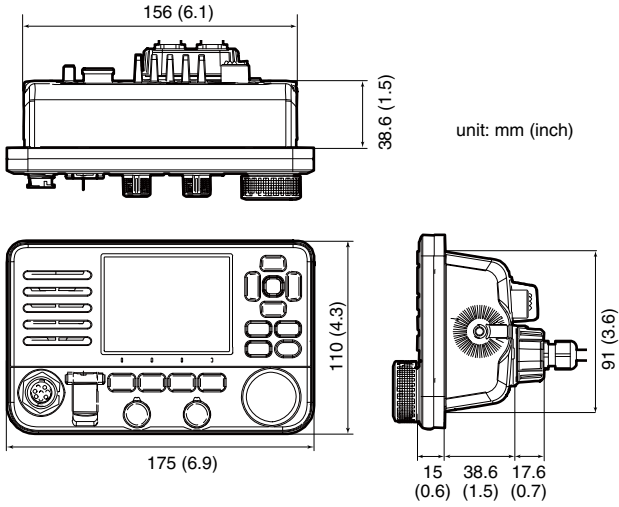



## ■ Options

- **MBF-7** FLUSH MOUNT KIT  
To mount the transceiver to a panel.
  
- **MBZ-1** FRONT PANEL COVER  
Attach to protect from Sun light.
  
- **HM-195GB/HM-195GW** COMMANDMIC<sup>IV</sup>™\*  
External microphone-type controller. Provides optional intercom operation. 6 meters (20 feet) microphone cable and mounting base included.  
HM-195GB: Black  
HM-195GW: White
  
- **HM-205RB** SPEAKER MICROPHONE  
Equipped with [▲]/[▼] (channel up/down), [H/L], [16/C] and [PTT] keys, a speaker and microphone.
  
- **OPC-1541** MICROPHONE EXTENSION CABLE  
6 meters (20 feet) microphone extension cable for optional HM-195. Up to two OPC-1541 can be connected. Usable length is 18 meters (60 feet) maximum.
  
- **OPC-1000** MICROPHONE EXTENSION CABLE  
6 meters (20 feet) microphone extension cable for HM-205RB.
  
- **SP-37** HORN SPEAKER  
The external horn speaker. Connect with the AF Out leads for the external speaker.  
① To use the RX Hailer function or the Horn function, connect to the CT-M500.
  
- **UT-112A** VOICE SCRAMBLER UNIT  
Ensures private communications. 32 codes are selectable. Not available in some countries. Ask your service center or technical dealer for installation details.
  
- **UX-241** GNSS ANTENNA  
To receive GPS signals.
  
- **RS-M500** REMOTE CONTROL SOFTWARE  
iOS/Android application that is used for remote operation of the IC-M510 through a WLAN connection.
  
- **CT-M500** EXTERNAL INTERFACE BOX  
To connect to the IC-M510 via wireless LAN to use the NMEA 2000 interface, the Hailer function, and the Horn functions.

# 14 TROUBLESHOOTING

## **The transceiver does not turn ON.**

- Bad connection to the power supply.  
→ Check the connection to the transceiver and power supply. (p.96)
- The fuse is blown.  
→ Repair the problem, and then replace the fuse. (p. 96)

## **Little or no sound comes from the speaker.**

- Squelch level is set too high.  
→ Set the squelch to the threshold point. (p. 12)
- Volume level is set too low.  
→ Set the volume level to a suitable level. (p. 12)

## **You cannot transmit with high power.**

- Some channels are set for low power or receive only by regulations.  
→ Change channels. (p. 10)
- The output power is set to low.  
→ Push **H/LO** to select high power. (p.7 )

## **Scan does not start.**

- More than 2 favorite channels are not set.  
→ Set at least 2 favorite channels. (p.17 )

## **No beep sounds.**

- The Key Beep function is OFF.  
→ Turn ON the function. (p. 82)

## **Individual or Group ID cannot be set.**

- The entered ID code is incorrect. The first digit must be set to between '1' and '9' for an Individual ID.  
→ Enter a correct ID code. (p. 19)

## **"??" blinks instead of the position and time.**

- 23.5 hours have passed since you manually entered the position.
- The GPS position is invalid.  
→ Enter the position and time. (p. 20)

## **"No Position" and "No Time" are displayed instead of the position and time.**

- The GPS antenna is not correctly connected.  
→ Check the GPS antenna connection. (p. 95)  
→ Check the cable connection to NMEA In/Out leads. (p.95)
- The position and time have not been manually entered.  
→ Enter the position and time. (p. 20)

## **Sensitivity is too low, and only strong signals can be heard.**

- The antenna is defective or the coaxial cable connector is shorted or cut.  
→ Repair the problem and then reconnect to the antenna connector. (p.95)

## **Communication cannot be established.**

- The antenna is defective or the coaxial cable connector is shorted or cut.  
→ Repair the problem and then reconnect to the antenna connector. (p.95)

### **The transceiver is locked up, and does not respond.**

- A software error has occurred.  
→ Turn OFF the transceiver, and then turn it ON again.

### **The transceiver does not work.**

- The transceiver's Phase Lock Loop is unlocked.  
→ Contact your dealer.

### **The collision alarm does not sound.**

- The collision alarm function is OFF.  
→ Turn ON the collision alarm function. (p. 60)

### **You cannot connect to the CT-M500 or the mobile devices.**

- The WLAN function is OFF.  
→ Turn ON the WLAN function. (p. 88)
- SSID is set incorrectly.  
→ Check the SSID on both the IC-M510 and the access point.
- CT-M500 is a bad connection to the power supply.  
→ Check the connection to the CT-M500 and power supply.

# 15 CHANNEL LIST

## ■ For IC-M510

**NOTE:** When the “Channel Display” is set to “3 digits” in the Radio setting, the channel number is displayed in 3 digits. See page 85 for details. (For example: “1001” is displayed as “01A.”)

Channel Number			Frequency (MHz)	
USA	INT	CAN	Transmit	Receive
	01	01	156.050	160.650
1001	1001		156.050	156.050
	02	02	156.100	160.700
	03	03	156.150	160.750
1003			156.150	156.150
	04		156.200	160.800
		1004	156.200	156.200
	05		156.250	160.850
1005	1005	1005	156.250	156.250
06	06	06	156.300	156.300
	07		156.350	160.950
1007	1007	1007	156.350	156.350
08	08	08	156.400	156.400
09	09	09	156.450	156.450
10	10	10	156.500	156.500
11	11	11	156.550	156.550
12	12	12	156.600	156.600
13* <sup>3</sup>	13	13* <sup>1</sup>	156.650	156.650
14	14	14	156.700	156.700
15* <sup>2</sup>	15* <sup>1</sup>	15* <sup>1</sup>	156.750	156.750
16	16	16	156.800	156.800
17* <sup>1</sup>	17	17* <sup>1</sup>	156.850	156.850
	18		156.900	161.500
1018	1018	1018	156.900	156.900
	19		156.950	161.550
1019	1019	1019	156.950	156.950
	2019		RX Only	161.550
20	20	20* <sup>1</sup>	157.000	161.600
1020	1020		157.000	157.000
	2020		RX Only	161.600
	21	21	157.050	161.650
1021	1021	1021	157.050	157.050
		2021	RX only	161.650

\*1 Low power only.

\*2 RX only.

\*3 Momentary High Power.

\*1 Low power only.

Channel Number			Frequency (MHz)	
USA	INT	CAN	Transmit	Receive
	22		157.100	161.700
1022	1022	1022	157.100	157.100
	23	23	157.150	161.750
1023	1023		157.150	157.150
		2023	RX only	161.750
24	24	24	157.200	161.800
25	25	25	157.250	161.850
		2025	RX only	161.850
26	26	26	157.300	161.900
27	27	27	157.350	161.950
	1027		157.350	157.350
28	28	28	157.400	162.000
	1028		157.400	157.400
		2028	RX only	162.000
	60	60	156.025	160.625
	61		156.075	160.675
1061		1061	156.075	156.075
	62		156.125	160.725
		1062	156.125	156.125
	63		156.175	160.775
1063	1063	1063	156.175	156.175
	64	64	156.225	160.825
1064		1064	156.225	156.225
	65		156.275	160.875
1065	1065	1065*1	156.275	156.275
	66		156.325	160.925
1066	1066	1066*1	156.325	156.325
67*3	67	67	156.375	156.375
68	68	68	156.425	156.425
69	69	69	156.475	156.475
71	71	71	156.575	156.575
72	72	72	156.625	156.625
73	73	73	156.675	156.675
74	74	74	156.725	156.725
75	75*1	75*1	156.775	156.775
76	76*1	76*1	156.825	156.825
77*1	77	77*1	156.875	156.875
	78		156.925	161.525

# 15 CHANNEL LIST

■ For IC-M510

Channel Number			Frequency (MHz)	
USA	INT	CAN	Transmit	Receive
1078	1078	1078	156.925	156.925
	2078		RX Only	161.525
	79		156.975	161.575
1079	1079	1079	156.975	156.975
	2079		RX Only	161.575
	80		157.025	161.625
1080	1080	1080	157.025	157.025
	81		157.075	161.675
1081	1081	1081	157.075	157.075
	82		157.125	161.725
1082	1082	1082	157.125	157.125
	83	83	157.175	161.775
1083	1083	1083	157.175	157.175
		2083	RX only	161.775
84	84	84	157.225	161.825
1084			157.225	157.225
85	85	85	157.275	161.875
1085			157.275	157.275
86	86	86	157.325	161.925
1086			157.325	157.325
87	87	87	157.375	157.375
1087			157.375	157.375
88	88	88	157.425	157.425
1088			157.425	157.425

**NOTE:** Simplex channels, 1021, 1023, 1081, 1082, and 1083 **CANNOT** be lawfully used by the general public in USA waters.

① See page 11 for details on the WX channel.

# TEMPLATE 16

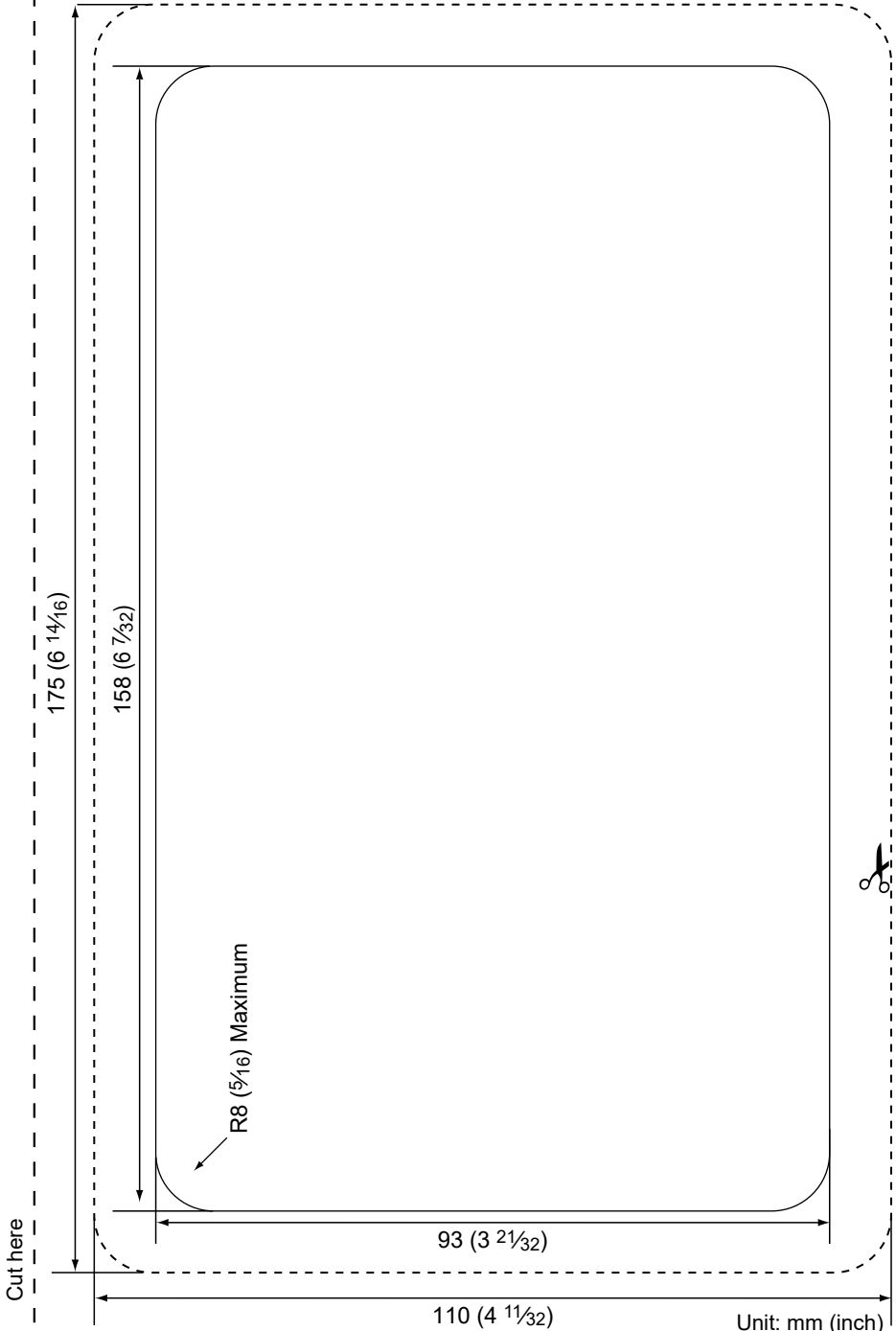





- A**
- Accessories
    - Speaker
      - Microphone.....3
    - Supplied accessories .....94
  - Access Point mode.....88
  - AIS
    - About AIS .....50
    - AIS classes .....50
  - AIS list
    - Danger list.....55
    - Friends list.....55
    - Target list.....55
    - Using.....54
  - Alarm Status (DSC Settings).....47
  - All Ships call
    - Receiving .....39
    - Sending.....27
  - Anchor Watch
    - Starting.....66
    - Stopping.....66
  - AquaQuake.....14
  - Auto ACK (DSC Settings).....46
- B**
- Backlight .....12
  - Configuration.....82
- C**
- Call channel
    - Radio settings .....84
    - Selecting .....10
    - Setting.....13
  - CH 70 SQL Level, DSC Settings .....47
  - Channel
    - Channel area .....5
    - Group.....10
    - Name, editing.....14
    - Selecting .....10
  - Channel 16 .....10
  - Channel Display
    - Radio Settings.....85
  - Channel Group
    - Radio settings .....84
  - CH Auto Switch, DSC Settings....46
  - Client mode .....91
  - Command microphone
    - COMMANDMIC
      - Speaker .....78
    - Display Contrast.....78
    - Highway screen .....77
    - Menu screen items..78
    - Plotter screen.....77
    - Soft key/Dial assignment .....78
  - CPA/TCPA
    - Alarm.....59
    - Audible Alarm.....59
    - CPA.....59
    - Slow Warn.....60
    - TCPA.....59
- D**
- Detail screen.....57
  - Distress call
    - Cancel call .....23
    - Receiving .....35
    - Regular call .....22
    - Sending.....21
    - Simple call.....21
    - Software Key.....23
  - DSC
    - Address ID .....19
    - Log, received .....43
    - Log, transmitted .....43
    - Settings .....46
  - DSC data output.....46
  - Dual/Tri-watch
    - Description .....18
    - Operation .....18
    - Radio settings .....84
- F**
- FAV on MIC
    - Radio Settings.....85
  - Favorite CH
    - Radio Settings.....84
  - Favorite channels .....17
  - Friend
    - Alarm.....60
    - Deleting.....56
    - Editing .....56
    - Entering.....56
    - List .....55, 60
  - Front panel .....2
  - Function Display .....4
  - Fuse replacement.....96
- G**
- GPS
    - Configuration.....83
  - Group.....10
  - Group call
    - Receiving .....39
    - Sending.....28
  - Group ID
    - Deleting.....20
    - DSC setting.....46

---

# INDEX

## H

Hailer ..... 74  
Highway ..... 69, 77  
Horn ..... 75

## I

ID Blocking  
  Deleting ..... 61  
  Editing ..... 61  
Inactivity Timer  
  Configuration ..... 83  
Individual Acknowledgment  
  Sending ..... 26  
Individual call  
  Receiving ..... 38  
  Sending ..... 25  
Individual ID  
  Deleting ..... 20  
  DSC Settings ..... 46  
  Entering ..... 19  
Intercom ..... 72

## K

Key Assignment  
  Configuration ..... 82  
Key Beep  
  Configuration ..... 82

## L

License  
  Operator ..... 1  
  Ship Station ..... 1  
Lock function ..... 15  
LO/DX  
  Radio Settings ..... 85  
Lost target ..... 71

## M

MA-510TR  
  Connecting ..... 96  
Man Overboard (MOB)  
  Starting ..... 65  
  Stopping ..... 65  
MBF-7 installation ..... 98  
Menu screen  
  Description ..... 82  
  Items ..... 80  
  Using ..... 79  
Microphone  
  Connecting ..... 2  
MMSI code, entering ..... 8  
Mounting  
  the transceiver ..... 97  
Multiple-task mode ..... 44

## N

Navigation  
  Resetting ..... 68  
  Starting ..... 67  
  Stopping ..... 68  
NMEA 0183 ..... 85  
NMEA 2000  
  Compatible  
    PGN list ..... 86  
NMEA over WLAN ..... 92  
Noise Cancel  
  Configuration ..... 83  
North up/Course up ..... 59

## O

Options ..... 104

## P

Panel Description ..... 2  
Plotter  
  Description ..... 51  
  Using ..... 51  
Polling  
  Reply call,  
    receiving ..... 42  
  Reply call, sending ..... 34  
  Request call,  
    sending ..... 31  
Position  
  Entering ..... 20  
  Input (DSC  
    Settings) ..... 46  
  Reply call,  
    receiving ..... 42  
  Reply call, sending ..... 32  
  Report call,  
    receiving ..... 41  
  Report Reply call ..... 34  
  Request call,  
    receiving ..... 40  
  Request call,  
    sending ..... 31  
Power Link ..... 92  
Power SW from MIC  
  Configuration ..... 83  
Procedure (DSC  
  Settings) ..... 47  
  

## R

Radio Info ..... 87  
Receiving ..... 13  
RX Hailer ..... 73  
  Configuration ..... 83

**S**

Scan	
Priority.....	16
Starting.....	17
Types .....	16
Scan Timer	
Radio settings .....	84
Scan Type	
Radio settings .....	84
Self Check Test	
(DSC Settings)...	47
Simple call,	
Distress call .....	21
Slow Warn .....	60
Software Keys .....	6
Specifications .....	101
Squelch level .....	12
Supplied accessories...	94

**T**

Target Display.....	59
Template .....	110
Test Acknowledgement	
Receiving .....	42
Sending.....	30
Test call	
Receiving .....	41
Sending.....	29
Time, entering.....	20
Transmitting.....	13

**U**

UTC Offset	
Configuration.....	82

**V**

Voice Scrambler .....	76
Radio settings .....	84
Volume level .....	12

**W**

Waypoint	
Deleting.....	64
Editing .....	64
Entering.....	63
List .....	62
Navigating .....	64
Weather Alert.....	11
Weather channels.....	11
WLAN Information .....	93
WLAN Reset.....	93
WX Alert	
Radio settings .....	84

**Count on us!**

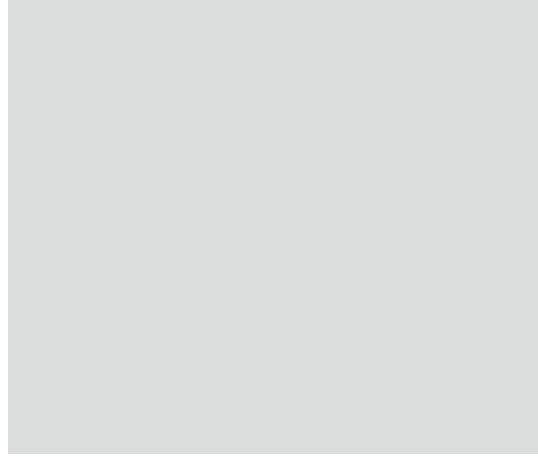

# Connecting your mobile device to the transceiver

You can use your mobile device as a wireless microphone or the remote controller by installing the RS-M500 REMOTE CONTROL SOFTWARE for Android/iOS and connect it to the IC-M510 through the wireless LAN (WLAN).

## Installation overview

You can connect your mobile device to the IC-M510 through a wireless LAN (WLAN) by the following steps:

### Step 1 On the transceiver:

1. Turn the WLAN function ON.
2. Select a WLAN connecting mode, the Access Point mode or the Client mode.
3. Enter the required information on configuring the IC-M510 WLAN in the Access Point mode or joining your WLAN in the Client mode.

Refer to “Step 1 WLAN setting on the transceiver” described below.

### Step 2 On the mobile device:

① The setting procedure depends on the mobile device model or its OS version.

1. Download the RS-M500 to your mobile device.
2. Open the wireless LAN setting screen of your mobile device, and then find the access point name (SSID) that you set to your IC-M510.
3. Enter the password, and then join the mobile device to the wireless network.
4. Open the RS-M500 application.  
① The RS-M500 automatically searches and connects to the IC-M510.

Refer to “Step 2 Setting up the RS-M500 on your mobile device” on the other side of this manual.

## Step 1 WLAN Setting on the transceiver

### ◇ Selecting the WLAN mode on the IC-M510

You can select the WLAN mode from the Access Point mode or the Client mode, according to your installation environment of the transceiver.

This manual mainly describes how to connect the IC-M510 and your mobile device using the Access Point mode.

#### ● The Access Point mode

The IC-M510 works as a wireless LAN access point to configure the local wireless network between your mobile device.

Normally use the Access Point mode.

① A maximum of 3 mobile devices and a CT-M500 can be connected to the IC-M510.

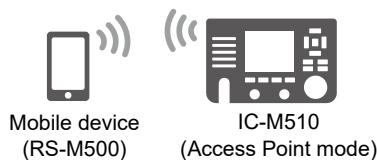

#### ● The Client mode

The IC-M510 works as a client device in an existing wireless network. In this case, the IC-M510 and your mobile devices must belong to the same wireless network.

Use the Client mode, if the connection is failed or poor when using the Access Point mode.

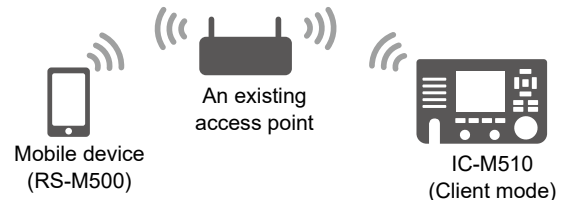

### Required settings on the IC-M510 Access Point mode

SSID (Network name)	Default: IC-M510_(8 digit serial number) Example: IC-M510_12345678
Security type	Default: WPA2/WPA
Password	Default: M510_(8 digit serial number) Example: M510_12345678

### Required information on joining your WLAN

- SSID (Network name)
- Password

① The Security type of the IC-M510 WLAN function is set to WPA2/WPA as default. You may be required to change the Security type or the default gateway settings, depending on your network environment. Ask your network administrator for details on your WLAN settings.

## ◇ Turning the WLAN function ON

1. Open the “Function” screen.

[MENU] > Setting > WLAN > **Function**

2. Select “ON,” and then push [ENT] or [CH/ENT].

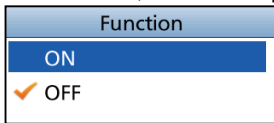

- “ON” is set, and the transceiver returns to the previous screen.

## ◇ Setting the WLAN in the Access Point mode

1. Open the “Configuration” screen.

[MENU] > Setting > WLAN > Advanced Setting > **Configuration**

2. Select “Access Point,” and then push [ENT] or [CH/ENT].

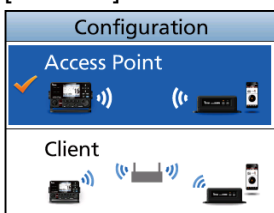

- The “Access Point Settings” screen is displayed.

- ① When “Requires reconfigure the CT-M500/phone. Change setting and reset the CT-M500?” is displayed, Push **OK**.

3. Push [▲] or [▼], or rotate [CH/ENT] to select the set items, and then push [ENT], [CH/ENT], or [▶].

### TIP:

- Select **A1** to enter numbers and letters, and **IS?** to enter symbols.
- Select characters or space using [▲], [▼], [◀], and [▶].
- Push [ENT] or [CH/ENT] to enter the selected character.
- Select “←” or “→” on the screen, or rotate [CH/ENT] to move the cursor.

### Set items

- SSID:** Up to 32 characters can be entered. “IC-M510\_(8 digit serial number of the transceiver)” is set as default.
- Security:** Select the authentication type. WPA2/WPA is set as default.
- Password:** Enter an authentication password of 8 to 63 characters. “M510\_(8 digit serial number of the transceiver)” is set as default. The entered password is masked like as “\*\*\*\*\*”.

- ① Set Channel, IP Address, and Subnet Mask, if necessary.

4. After setting the items, push **Save**, and return to the Standby screen.
  - ① When the WLAN connection is successful, the “” icon is displayed at the top of the screen.

## Step 2 Setting up the RS-M500 on your mobile device

- ① The setting procedure depends on the mobile device model or its OS version.

1. Access the Play Store (Android OS) or App Store (iOS), then find and download the RS-M500 to your mobile device.
2. Open the wireless LAN setting screen of your mobile device, and then select the SSID (for example: IC-M510\_12345678) you set to your transceiver in Step 1.
3. Enter the password (for example: M510\_12345678), and then join the mobile device to the network.
4. Open the RS-M500 application.
  - The RS-M500 automatically searches and connects to the IC-M510. When the screen shown below is displayed, the RS-M500 is ready to operate.

- ① When the connection between the RS-M500 and the IC-M510 is successful, the “” icon is displayed at the top of the IC-M510 screen.

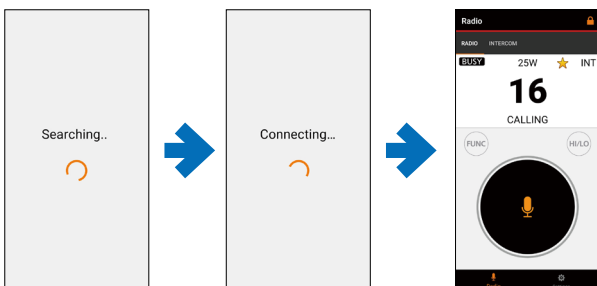

**NOTE:** If an error message is displayed, check that the WLAN is properly set and connected, the transceiver is turned ON, and then touch “Retry.”

Touching “Continue” starts the application without connecting to a transceiver.

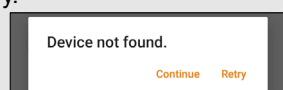

Refer to the RS-M500 manual for details on the RS-M500 operation. The manual can be downloaded from the Icom website:  
<https://www.icomjapan.com/support/>