

## OWNER'S MANUAL

# MX500/4

500W Full-Range 4-Channel Class D Amplifier



**NexD**  
SWITCHING TECHNOLOGY

Thank you for purchasing a JL Audio amplifier for your sound system.

Your amplifier has been designed and manufactured to exacting standards, in order to ensure years of musical enjoyment. For maximum

performance, we highly recommend that you have your new amplifier installed by an authorized JL Audio dealer. Your

authorized dealer has the training, expertise and installation equipment

to ensure optimum performance from this product. Should you

decide to install the amplifier yourself, please take the time

to read this manual thoroughly to familiarize yourself

with its installation requirements and setup procedures.

If you have any questions regarding the instructions in this

manual or any aspect of your amplifier's operation, please contact your

authorized JL Audio dealer for assistance. If you need further assistance,

please call the JL Audio Technical Support Department

at [technical@jlaudio.com](mailto:technical@jlaudio.com) or call (954) 443-1100 during business hours.



### What's Included

- 1) Amplifier
- 4) Stainless steel mounting screws
- 1) User manual

### Product Description

This is a four-channel, full-range audio amplifier utilizing Class D technology for all channels.

### Installation Applications

This amplifier is designed for operation with 12 volt, negative-ground electrical systems. Using this product in systems with positive ground and/or voltages other than 12V may result in damage to the product and will void the warranty. This product is not certified or approved for use in aircraft.

### Safety Considerations

- Whenever possible, mount the amplifier in a dry, well-ventilated location that does not interfere with other factory installed electronic devices. If a dry environment is not available, a location that is not exposed to heavy splashing may be used.
- While this amplifier is designed to be water-resistant, it should never be submerged under water or subjected to high-pressure water spray.
- Do not install where it will be directly exposed to the elements.
- Do not mount the amplifier in the engine compartment or in any areas of extreme heat.
- Securely mount the amplifier so that it does not come loose in the event of a collision/sudden jolt or as a result of repeated vibrations during normal operation.
- Check before drilling to make sure that you will not be drilling into an exterior panel/hull, fuel tank, gas/brake line, wiring harness, or other vital system.
- Do not run system wiring outside or underneath the vehicle/vessel. This is an extremely dangerous practice, which can result in severe damage/injury.
- Protect all system wires from sharp edges (metal, fiberglass, etc.) by carefully routing them, tying them down and using grommets and loom where appropriate.
- Secure all wiring as needed, using cable ties or wire clamps to protect them from moving parts and sharp edges.

### IPX7 Water Resistance Rating

This product has been tested to withstand immersion in water, up to 1 meter (3.28 ft.) deep, for up to 30 minutes (with control panel cover properly installed). Note - while designed to be water resistant, this product should never be submerged under water for prolonged periods or subjected to activity that creates pressure on it that exceeds its depth rating.

### Installation Procedure/Connections

1. Disconnect the NEGATIVE battery post connection and secure the disconnected cable to prevent accidental reconnection during installation. **This is an essential safety precaution during installation!**
2. Connect the RED power lead to the positive (+12V) battery post. **4 AWG is the minimum power wire size for this amplifier.**
3. An appropriate fuse (sold separately), such as the JL Audio Water-Resistant Master MAX™ Fuse Block (XD-MFBW-MAXI), at the main power wire(s) to the amplifier(s) is vital for vehicle/vessel safety. This fuse must be installed within 18 inches (45 cm) of the positive battery post connection. If this is the only device connected to this main wire, use a 50A fuse. Do not install the fuse until the power wire has been securely connected to the amplifier. Connect the BLACK negative ground lead to a clean, solid metal grounding point near the amplifier. This can be to metal chassis ground, if available, if no metal chassis ground is available, it may be necessary to make this connection to the NEGATIVE battery post. **4 AWG is the minimum ground wire size for this amplifier. All ground connections (source unit and amplifiers) should be made at the same location.**
5. Connect the BLUE remote turn-on lead to the source unit's positive (+12V) remote turn-on output. If your source unit does not have a dedicated remote turn-on output, the amplifier's turn-on lead can be connected to +12V via a switch that derives power from an ignition-switched circuit.
6. Signal Input (Low-Level): Connect the amplifier's RCA input jacks to the source unit's preamp level output jacks.
7. Signal Input (Hi-Level): If your source unit does not offer preamp level signal outputs, you can splice the speaker output wires of the source unit onto a pair of RCA plugs for each input pair or use the JL Audio ECS Speaker Wire to RCA adaptor (XD-CLRAIC2-SW). Make sure to observe correct polarity in making "Hi-Level Input" connections. Failure to do so will result in a loss of signal (poor performance).
8. Connect the speaker output leads to the corresponding speaker wires.
9. Make necessary adjustments to the filter controls and input sensitivity.

**WARNING! Failure to make safe, tight, high-integrity power connections can result in fire and extensive damage!**

### Control Panel Settings and Adjustments

The amplifier's settings and controls are located on the bottom panel beneath a gasketed, protective cover. Remove the four Phillips head screws from the center panel to access the controls and make adjustments. Replace cover when finished and mount the amplifier.

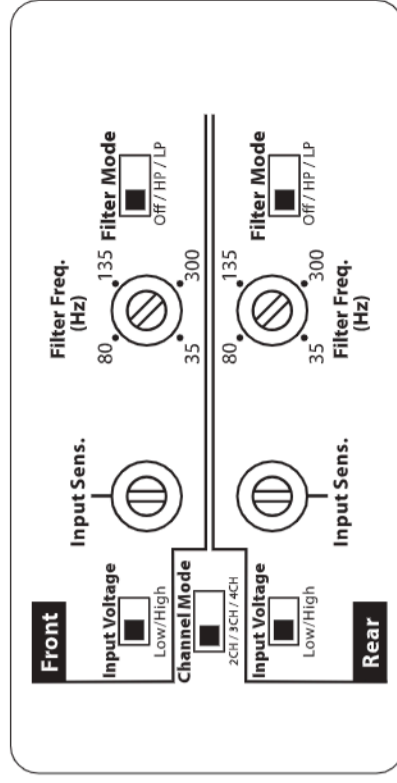

Control	Setting	Mode / Function
Channel Mode	2CH	#1) 4 Stereo Outputs (non-fading) Use Front Inputs Only
	3CH	#2) 2 Bridged Mono Outputs Use Front Inputs Only
	4CH	#1) 2 Stereo Front + 2 Mono Rear Outputs Use Front and Rear Inputs
		#2) 2 Stereo Front + 1 Bridged Mono Rear Output Use Front and Rear Inputs
Input Voltage	Low	RCA/Preamp Level Range (250 mV - 4 V)
	High	RCA/Preamp or Speaker Level Range (750 mV - 15 V)
Filter Mode	Off	Full-Range Operation of Input Signals
	HP	(High-Pass) Configures Filter to Attenuate Frequencies BELOW the Selected Filter Frequency
Filter Mode	LP	(Low-Pass) Configures Filter to Attenuate Frequencies ABOVE the Selected Filter Frequency
	Variable	Adjusts the filter cutoff frequency of the selected Filter Mode, variable from 35-300 Hz, 12 dB/Octave
Input Sens.	Variable	Adjusts the input stage of each pair of amplifier channels to match the source unit's output voltage for maximum clean output (refer to Appendix A)

### Connections

Label	Wire Color	Description
+12V	Red	Positive (+12V) Power Connection
GND	Black	Negative (GND) Ground Connection
REM	Blue	Positive (+12V) Remote Turn-On Input
FL+	White	Ch. 1 (+) Positive Front Left Speaker output
FL-	White/Black	Ch. 1 (-) Negative Front Left Speaker output
FR+	Gray	Ch. 2 (+) Positive Front Right Speaker output
FR-	Gray/Black	Ch. 2 (-) Negative Front Right Speaker output
RL+	Green	Ch. 3 (+) Positive Rear Left Speaker output
RL-	Green/Black	Ch. 3 (-) Negative Rear Left Speaker output
RR+	Purple	Ch. 4 (+) Positive Rear Right Speaker output
RR-	Purple/Black	Ch. 4 (-) Negative Rear Right Speaker output
Label	Plug	Description
FRONT IN	White RCA	Ch. 1 / Front Left Channel Signal Input
FRONT IN	Red RCA	Ch. 2 / Front Right Channel Signal Input
REAR IN	White RCA	Ch. 3 / Rear Left Channel Signal Input
REAR IN	Red RCA	Ch. 4 / Rear Right Channel Signal Input

Specifications	MX500/4
Rated RMS Power @ 14.4V, <1% THD+N	70W x 4 @ 4 Ω 125W x 4 @ 2 Ω
Rated RMS Power @ 12.5V, <1% THD+N	55W x 4 @ 4 Ω 90W x 4 @ 2 Ω
Frequency Response	20 Hz - 20 kHz (+0, -1dB), 6.3 Hz - 30 kHz (+0, -3dB)
S/N Ratio, A-weighted, 20 kHz noise bandwidth	88 dB (Referred to rated power), 68 dB (Referred to 1 W)
Damping Factor	>92 / 50 Hz @ 4 Ω, >43 / 50 Hz @ 2 Ω
Input Voltage Range	250 mV - 4 V (Low) or 750 mV - 15 V (High)
Filter Modes	Low-Pass or High-Pass, defeatable
Filter Freq. Range, Slope	35 - 300 Hz, 12 dB/Octave
Detented Filter Frequency Potentiometers	35, 80, 135, 300 Hz (Calibrated)
Input Mode Switch	2 / 3 / 4 Channel
Min Power/GND Wire	4 AWG
Fuse Rating	50A
Dimensions	9.33 in x 4.50 in x 1.77 in / 237 mm x 114.5 mm x 45 mm

### Status LED's / Protection Circuitry

There are two status indicator lights on the wiring end panel of the amplifier.

1. "POWER" (Green): Lights to indicate that the amplifier is turned on and operating normally.
2. "PROTECT" (Red): Lights to indicate the amplifier's protection circuitry has been activated to prevent product failure due to thermal overload, over current or short-circuit to the amplifier's outputs. When this protection mode is activated, the amplifier will shut down to protect its circuitry. When the problem is corrected, the amplifier will return to normal operation and the "Protect" LED will shut off. Connecting the speaker outputs to impedances lower than 2 ohms stereo (4 ohms bridged) will also cause this protection mode to activate.

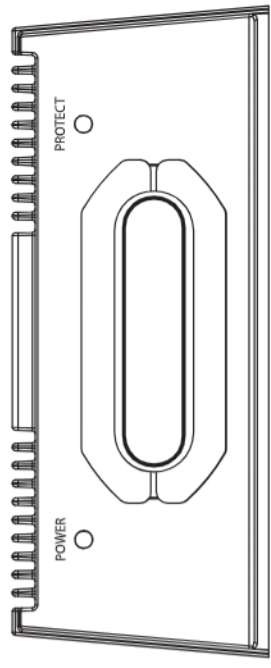

POWER (Green LED)	PROTECT (Red LED)	Status	Note
ON	OFF	Normal Operation	
OFF	ON	Thermal Protection	Lasts until temp cools to normal
OFF/ON	ON/OFF	Over Current	Green/Red LEDs alternate for 1 second
OFF	ON	Short Circuit	Possible audible "popping" noise

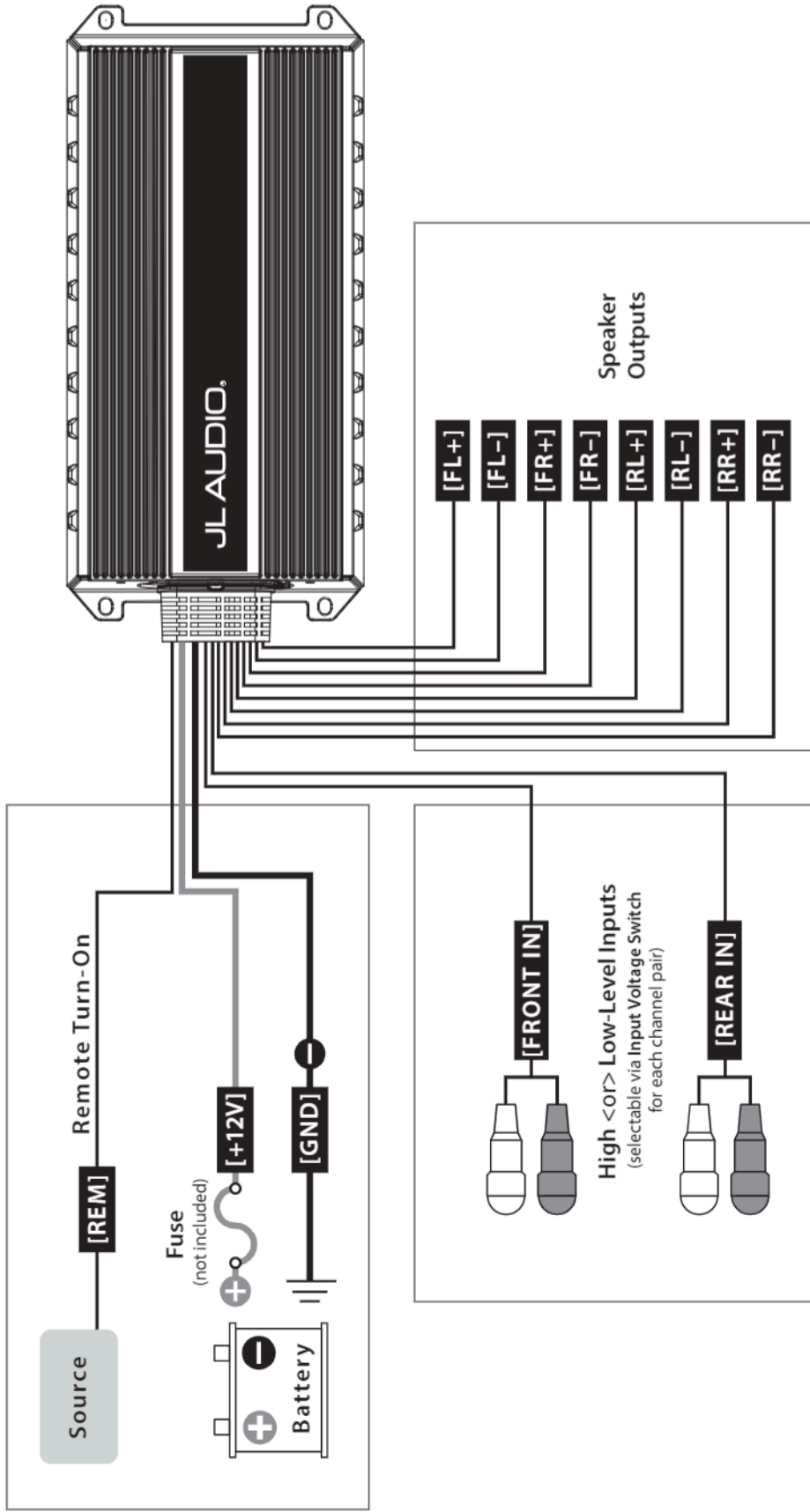

**4 Stereo Outputs (non-fading)**  
 Channel Mode: 2CH  
 Inputs: Use Front Inputs Only  
 RMS Power: 70W x 4 @ 4 Ω, (125W x 4 @ 2 Ω)

**Amplifier Inputs**

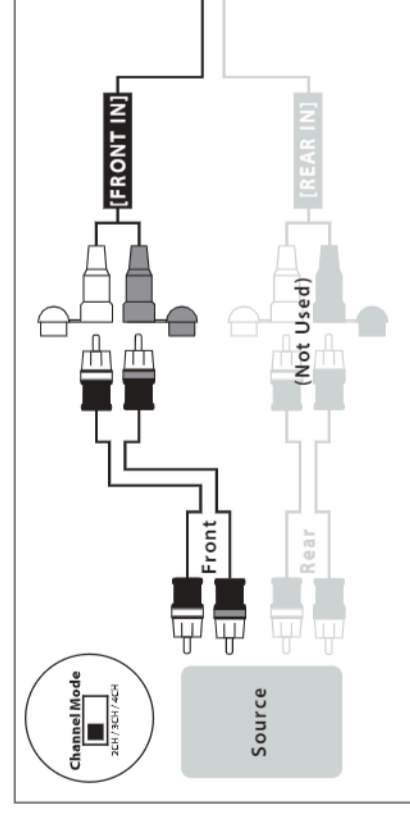

**Speaker Outputs**

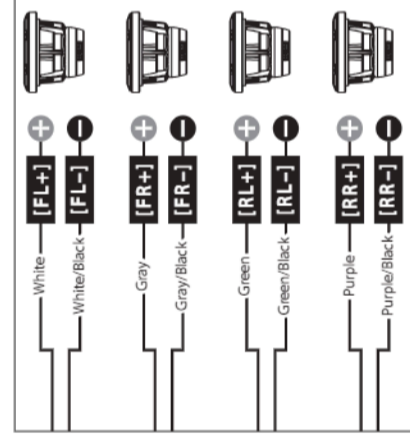

**4 Stereo Outputs (fading)**

Channel Mode: 4CH  
 Inputs: Use Front and Rear Inputs  
 RMS Power: 70W x 4 @ 4 Ω, (125W x 4 @ 2 Ω)

**Amplifier Inputs**

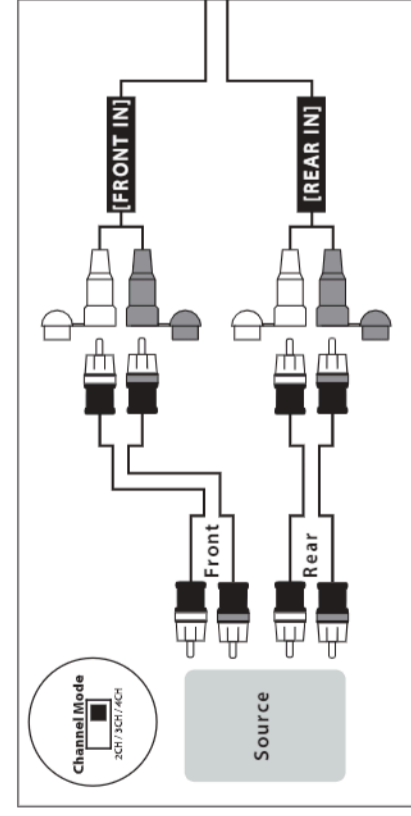

**Speaker Outputs**

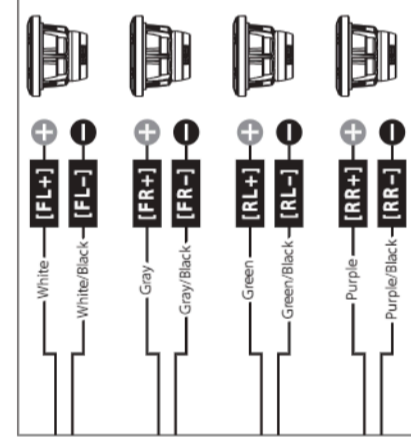

**2 Bridged Mono Outputs**

Channel Mode: 2CH  
 Inputs: Use Front Inputs Only  
 RMS Power: 250W x 2 @ 4 Ω

**Amplifier Inputs**

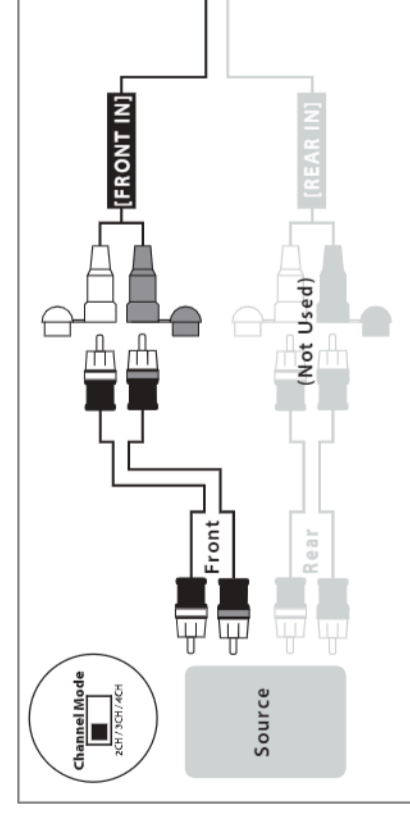

**Speaker Outputs**

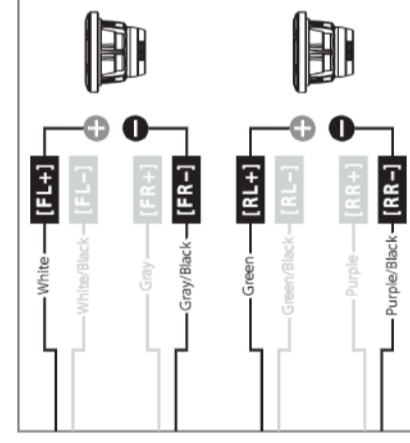

**2 Bridged Stereo Outputs**

Channel Mode: 4CH  
 Inputs: Left Signal to Both Front Inputs / Right Signal to Both Rear Inputs  
 RMS Power: 250W x 2 @ 4 Ω

**Amplifier Inputs**

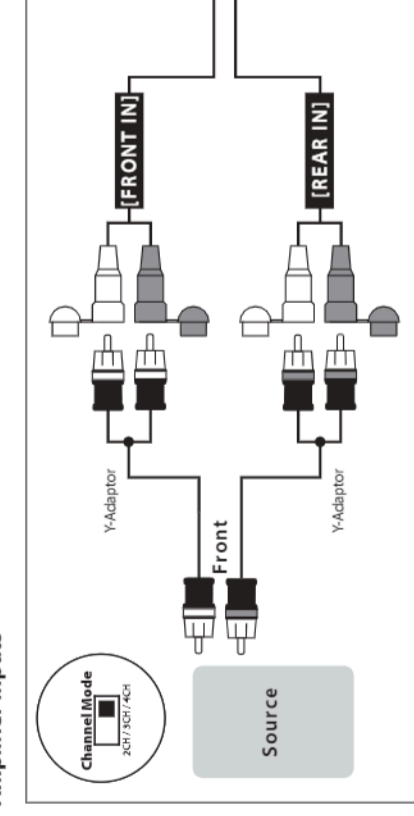

**Speaker Outputs**

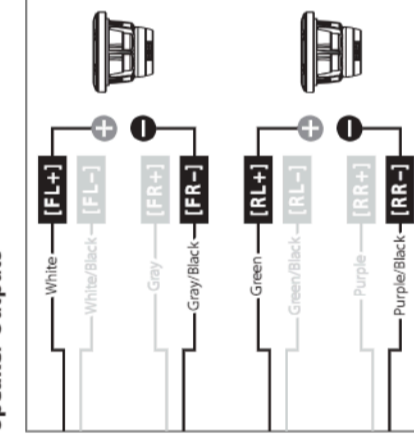

**2 Stereo Front + 2 Mono Rear Outputs**

Channel Mode: 3CH  
 Inputs: Use Front Inputs Only  
 RMS Power: 70W x 4 @ 4 Ω, (125W x 4 @ 2 Ω)

**Amplifier Inputs**

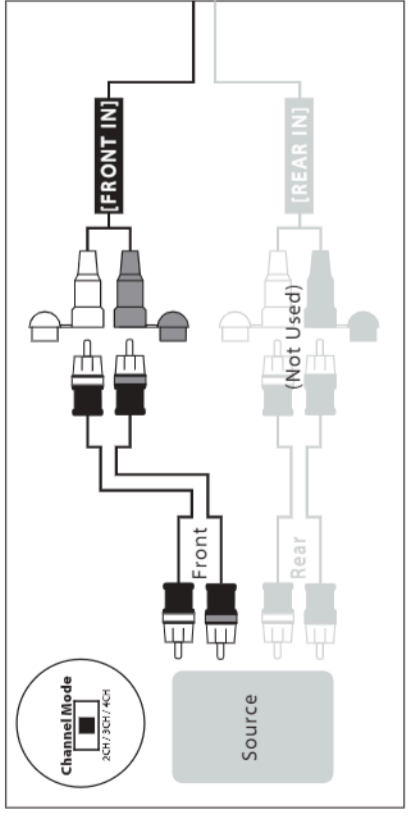

**Speaker Outputs**

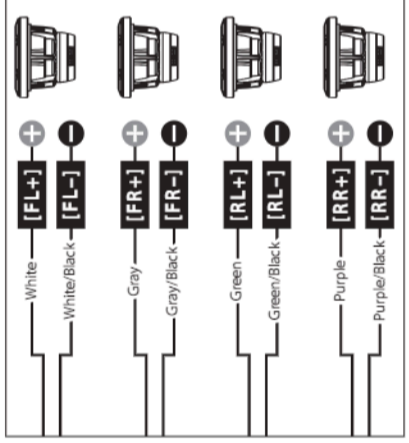

**2 Stereo Front + 1 Bridged Mono Rear Output**

Channel Mode: 3CH  
 Inputs: Use Front Inputs Only  
 RMS Power: 70W x 2 @ 4 Ω, (125W x 2 @ 2 Ω) + 250W x 1 @ 4 Ω

**Amplifier Inputs**

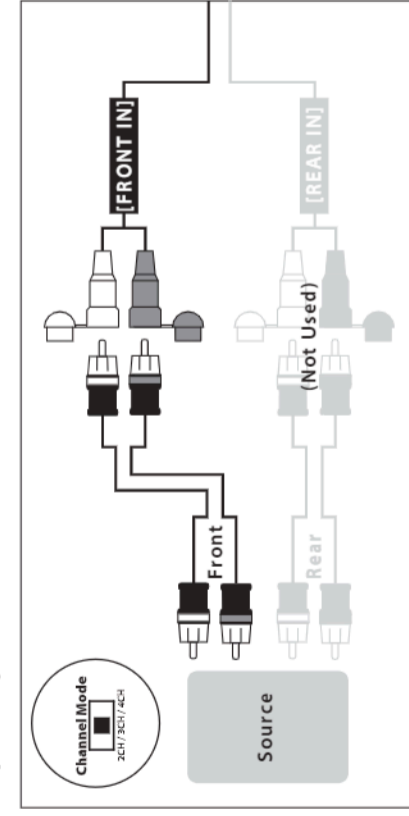

**Speaker Outputs**

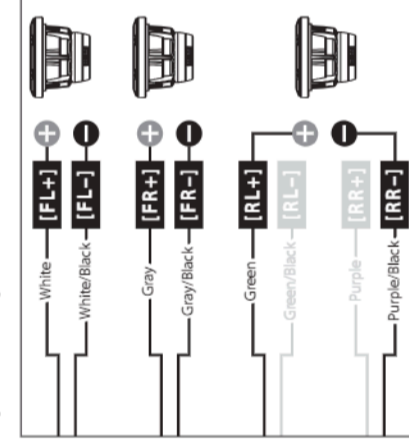

	ENGLISH	ESPAÑOL	FRANCAIS	DEUTSCH
FL+	White	Blanco	Blanc	Weiß
FL-	White/Black	Blanco/Negro	Blanc/Noir	Weiß/Schwarz
FR+	Gray	Gris	Gris	Grau
FR-	Gray/Black	Gris/Negro	Gris/Noir	Grau/Schwarz
RL+	Green	Verde	Vert	Grün
RL-	Green/Black	Verde/Negro	Vert/Noir	Grün/Schwarz
RR+	Purple	Púrpura	Violet	Lila
RR-	Purple/Black	Púrpura/Negro	Violet/Noir	Lila/Schwarz

**Appendix A:**

**Input Sensitivity Level Setting**

Following the directions below will allow the installer to adjust the input sensitivity of each amplifier channel pair in just a few minutes using equipment commonly available in installation bays.

**Necessary Equipment**

- Digital AC Voltmeter
- CD or file with a sine-wave test tone recorded at 0 dB reference level in the frequency range to be amplified for that set of channels (50 Hz for subwoofer channels, 1 kHz for a midrange application). Do not use attenuated test tones (-10 dB, -20 dB, etc.).

**The Nine-Step Procedure**

- 1) Disconnect the speakers from the amplifier's speaker output connectors (you need only disconnect one speaker wire).
- 2) Turn off all processing (bass/treble, loudness, EQ, etc.) on the source unit, processors (if used) and amplifier. Set the source unit's fader control to center position and its subwoofer level control to 3/4 of maximum.
- 3) Turn the "Input Sens." control all the way down.
- 4) Set the source unit volume to 3/4 of full volume. This will allow for reasonable gain overlap with moderate clipping at full volume.
- 5) Using the chart on this page, determine the target voltage for input sensitivity adjustment according to the nominal impedance of the speaker system connected to the amplifier outputs.
- 6) Verify that you have disconnected the speakers before proceeding. Play a track with an appropriate sine wave (within the frequency range to be amplified) at 3/4 source unit volume.
- 7) Connect the AC voltmeter to the speaker output connectors of the amplifier. Make sure you test the voltage at the correct connectors (+ and -).
- 8) Increase the "Input Sens." control until the target voltage is observed with the voltmeter.
- 9) Once you have adjusted the amplifier to its maximum low-distortion output level, reconnect the speaker(s) and listen to the system. The "Input Sens." controls can now be adjusted downward if the amplifier requires attenuation to achieve the desired system balance.

	MX500/4	Target AC Voltage
Nom. Impedance	4Ω	16.7 V
	2Ω	15.8 V
	Bridged to 4Ω	31.6 V

**IMPORTANT**

Do not increase any "Input Sens." setting for any amplifier channel or channel pair in the system beyond the maximum level established during this procedure. Doing so will result in audible distortion and possible speaker damage.

It will be necessary to re-adjust the "Input Sens." for the affected channels if any equalizer boost is activated after setting the "Input Sens." with this procedure. This applies to any EQ boost circuit, including source unit tone controls or EQ circuits. EQ cuts will not require re-adjustment.

**Troubleshooting**

Problem	Possible Cause	Solution
How to properly set input sensitivity		Please refer to Appendix A to set the input sensitivity for maximum, low-distortion output.
Amplifier doesn't turn on	Faulty fuse Poor connection integrity Insufficient "Remote" input	Remove fuse and check with continuity meter. Replace if necessary. Check "+12V", "Ground", and "Remote" leads for pinched wires; ensure tight connections. Make sure there is a sufficient +12V supply at the "Remote" connection; if not a relay may be required.
Intermittent output, fluctuates when I tap on it or hit a bump	Poor connection integrity	Make sure insulation has been properly stripped back at connection points for good contact area. Make sure input connectors are making good contact with input jacks of the amplifier.
Distorted, attenuated, or popping sound	Faulty speaker connection (Short Circuit / Over Current Protection)	Inspect speaker wires for possible short-circuit, either together or shorted to the vehicle's chassis ground. Check the nominal load impedance at the amplifier is equal to or greater than 2 ohms stereo (4 ohms bridged).
Output shuts off after a while	Overheating condition (Thermal Protection)	Make sure amplifier mounting area has adequate space for ventilation and heat dissipation.

**Limited Warranty – Amplifiers (USA)**

JL Audio warrants this product to be free of defects in materials and workmanship for a period of two (2) years from the original date of purchase. This warranty is not transferable and applies only to the original purchaser from an authorized JL Audio dealer. Should service be necessary under this warranty for any reason due to manufacturing defect or malfunction, JL Audio will (at its discretion), repair or replace the defective product with new or remanufactured product at no charge. Damage caused by the following is not covered under warranty: accident, misuse, abuse, product modification or neglect, failure to follow installation instructions, unauthorized repair attempts, misrepresentations by the seller. This warranty does not cover incidental or consequential damages and does not cover the cost of removing or reinstalling the unit(s). Cosmetic damage due to accident or normal wear and tear is not covered under warranty.

**Warranty is void if the product's serial number has been removed or defaced.**

Any applicable implied warranties are limited in duration to the period of the express warranty as provided herein beginning with the date of the original purchase at retail, and no warranties, whether express or implied, shall apply to this product thereafter. Some states do not allow limitations on implied warranties, therefore these exclusions may not apply to you. This warranty gives you specific legal rights, and you may also have other rights, which vary from state to state.

**If you need service on your JL AUDIO product:**

All warranty returns should be sent to JL Audio's Amplifier Service Facility freight-prepaid through an authorized JL Audio dealer and must be accompanied by proof of purchase (a copy of the original sales receipt). Direct returns from consumers or non-authorized dealers will be refused unless specifically authorized by JL Audio with a valid return authorization number. Warranty expiration on products returned without proof of purchase will be determined from the manufacturing date code. Coverage may be invalidated as this date is previous to purchase date. Non-defective items received will be returned freight-collect. Customer is responsible for shipping charges and insurance in sending the product to JL Audio. Freight damage on returns is not covered under warranty.

**For Service Information in the U.S.A. please call**

**JL Audio Customer Service:**  
 (954) 443-1100  
 9:00 AM – 5:30 PM (Eastern Time Zone)  
**JL Audio, Inc.**  
 10369 North Commerce Pkwy.  
 Miramar, FL 33025  
 (Do not send product for repair to this address)

**International Warranties:**

Products purchased outside the United States of America are covered only by that country's distributor and not by JL Audio, Inc.