

MS-BT200
MARINE BLUETOOTH MODULE
FOR MS-RA205 AND 700 SERIES
USER MANUAL



P/N: PAK001040B



WARNINGS AND CAUTIONS

Do not attempt to open the enclosure. There are no user-serviceable parts inside. Take care when handling.

REGISTER YOUR PRODUCT ONLINE:

For your own peace of mind, register your product purchase online at www.fusionelectronics.com

We'll keep you up to date with any news related to your product, any software upgrades or new accessories to help you get the most from your product.

This product is backed by a 1 Year Limited Consumer Warranty.

RECORD YOUR PRODUCT DETAILS HERE:

SERIAL NUMBER: _____

DATE OF PURCHASE: _____

AFFIX RECEIPT HERE:



OVERVIEW

The MS-BT200 Bluetooth module is designed to provide Bluetooth audio streaming from a compatible smartphone or media player directly to your FUSION marine stereo. The MS-BT200 is connected to the Satellite Radio (SiriusXM™) connector of your stereo.

The MS-BT200 supports audio streaming and control (Play/Pause/Next/Back) of the media device from the FUSION Stereo. Display of song information is also supported (when available). Whether you have an iPhone, Android, BlackBerry or Windows smartphone you can enjoy your favourite tracks while you are onboard your vessel through FUSION's superior marine entertainment stereos and speakers.

The MS-BT200 does **NOT** provide phone call control. Hands free operation of the phone is not supported from the FUSION stereo.

A 1.5m(5ft) long cable is provided to allow an optimal mounting position to maximize the Bluetooth range.

INSTALLATION

INSTALLATION WARNING

- Investigate the marine vessel's fuel tanks and electrical wiring locations before you begin installation
- Ensure all wiring is protected to avoid damage
- The MS-BT200 can not be operated simultaneously with a Satellite Radio (SiriusXM™) receiver. For installations where the Satellite Radio (SiriusXM™) connector is not available the FUSION MS-BT100 audio only Bluetooth module is recommended.

FUSION SATELLITE RADIO (SiriusXM™) CONNECTOR

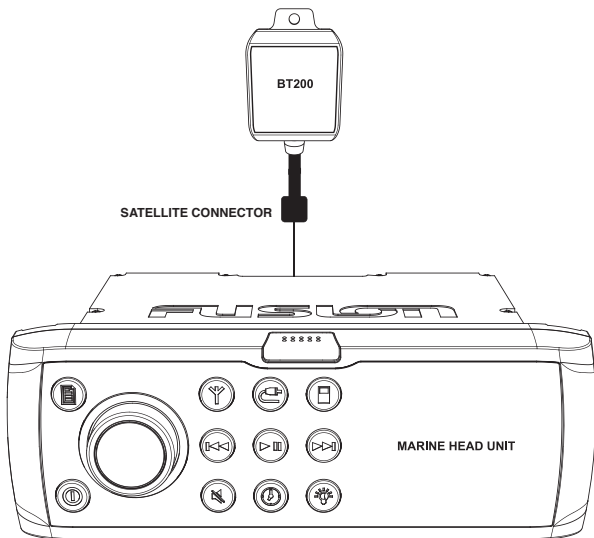

MOUNTING THE MS-BT200

FUSION recommends that the MS-BT200 is mounted in an elevated position as far away from metal work as possible. This will ensure maximum range for Bluetooth audio streaming.

Any barrier between the MS-BT200 and your streaming device will reduce the range. Line-of-sight operation will provide the best performance.

The MS-BT200 can be secured by either using the adhesive pad or by using a 6 gauge, pan head, self tapping, non-corrosive screw. Please ensure that the mounting surface is flat, clean and dry prior to applying the adhesive backing tape. The surface can be cleaned with an alcohol swab.

When mounting using the screw hole, ensure that the surface is flat and tightening the screw does not distort the case.

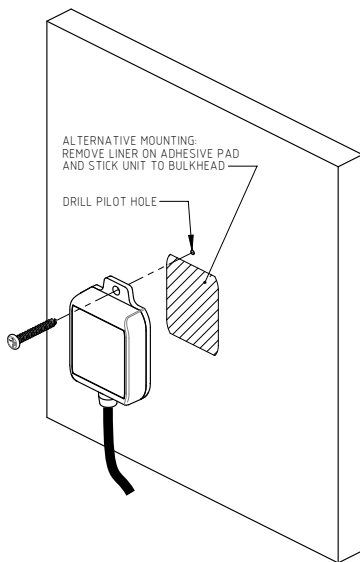

MS-BT200 CONNECTION

The MS-BT200 is connected to the Satellite Radio [SiriusXM™] connector of your FUSION stereo. The FUSION stereo provides power, data and audio connections via the Satellite Radio [SiriusXM™] connector.

Important Notes;

1. Extra care must be taken to ensure the orientation and connector pins are aligned correctly before inserting the connector, to avoid the risk of damaging pins. Do not force this connection.
2. It is highly recommended the connection is protected from the harsh marine environment. The connection should be mechanically secured by wrapping it in a marine grade water resistant adhesive tape. This will also protect the connection from possible water ingress if exposed to the marine environment.

FUSION STEREO FIRMWARE COMPATIBILITY

Ensure your FUSION Stereo software version supports Bluetooth (FUSION-Link: 1.20 or Higher). The FUSION-Link version is displayed in the "About" screen of your FUSION Stereo. Please refer to your Stereo user manual for more information on accessing the About screen from the menu and upgrading your FUSION stereo software.

Visit www.fusionelectronics.com for up to date software information.

OPERATION

SELECTING THE BLUETOOTH SOURCE ON THE MS-RA205 AND 700 SERIES



Once you have installed the MS-BT200 you will need to enable the Bluetooth source. This operation will be determined by the Tuner region you have selected.

Tuner Region - USA

When USA Tuner region is selected, press the menu button and select Settings→Sources→Accessory then select the source to enable SiriusXM or Bluetooth.

Tuner Region - Australasia-Europe-Japan

In these Tuner regions once the MS-BT200 is installed and connected the source will be available.



After installation, the MS-BT200 will be powered on and off when the marine head unit is powered on and off. The MS-BT200 is a Bluetooth device, so you will need to "pair" with it before you can start streaming music to your FUSION Stereo.

BLUETOOTH PAIRING

To pair with the MS-BT200 you first need to "discover" it from your Bluetooth compatible device. Please refer to your smartphone or media player user manual to start the Bluetooth discovery mode. Ensure the MS-BT200 is discoverable: In Bluetooth Source - Select Menu → Discoverable.

Once pairing is complete it is advisable to disable the Discoverable mode to prevent potential interruption to audio streaming.

The name of the MS-BT200 in discovery (pairing) mode is the same name given to your FUSION Stereo. The default name is the stereo Product Name e.g. "MS-700". Please select this device to connect. The MS-BT200 does not require a PIN number to pair.

CHOOSING A DEVICE FROM THE PAIRED LIST



In Bluetooth source press the menu button to display the paired device list. A tick box will confirm the current selected device. To select a different device on the list, turn the encoder to highlight and then select by pressing the encoder. There is a maximum of 8 devices that can be stored in the paired device list. Only one device can be actively connected.



REMOVE A DEVICE FROM A PAIRED LIST

In Bluetooth source press the menu button and scroll down to "Remove Device". Turn the encoder to highlight a device and press to remove from the list.

AUTO CONNECTION FUNCTION

Once the FUSION stereo is powered on in any source, the MS-BT200 will search for devices within range that are on the paired list. The last connected device in range will be automatically connected. If the device moves out of range, "Select Device" will be displayed on the FUSION stereo display until the device moves back into range or another device is connected. Alternatively, another device can be selected from the FUSION Stereo paired list as described above.



PLAYING MUSIC

Please ensure that your marine head unit source selection is set to Bluetooth. After your smartphone or media player is paired, you can use your music player application on the media player to select and play music over Bluetooth. Music selection is controlled from your smartphone or media player. Basic audio control is available from the FUSION Stereo.

SONG INFORMATION DISPLAYED ON YOUR FUSION STEREO

The Bluetooth Source Screen on your FUSION stereo can display the following (depending on your phone and music application);

- Song Title
- Artist Name
- Album Name
- Play Status – PLAY/PAUSE
- Song duration and elapsed time

RECEIVING PHONE CALLS



The exact operation is dependent on your Smartphone brand and model. On most Smartphones if you are streaming music and you receive a phone call, the music will pause and the ring tone will be played through your smartphone speaker. If you answer the phone, the call will not be played through the marine head unit. Once the call is completed, the music will automatically start playing again.

The MS-BT200 does not provide phone call control. Hands free operation of the phone is not supported from the FUSION Stereo.



TECHNICAL SPECIFICATIONS

Cable length:	1.5m (5ft)
Water Resistant Design:	IP65 enclosure
Bluetooth:	V3.0 Class 2 A2DP, AVRCP
Operating range:	≥ 10m (33ft)
Dimensions:	59mm (h) x 42mm (w) x 15mm (d)
Compliances:	FCC CE, C-Tick

TROUBLESHOOTING

Problem	Solution
When I play music on my smartphone there is no audio output through the main head unit.	<ul style="list-style-type: none">• Ensure that you have paired with the MS-BT200 (please refer to your smartphone or media player user manual).• Ensure that your smartphone's music player is configured to play music over Bluetooth.• Ensure that the marine head unit is powered on and the Bluetooth input source is selected.• Ensure the MS-BT200 is connected to the Satellite Radio (SiriusXM) connector as per the installation instructions.
When I search for Bluetooth devices I am unable to find the FUSION MS-BT200 on my smartphone	<ul style="list-style-type: none">• The name of the MS-BT200 in discovery (pairing) mode is the same name given to your FUSION Stereo. The default name is the stereo Product Name e.g. "MS-700".• Ensure that the marine head unit and MS-BT200 are powered on.• Ensure the MS-BT200 is connected to the Satellite Radio (SiriusXM) connector as per the installation instructions.• Ensure the Satellite Radio (SiriusXM) port is configured for Bluetooth operation. Bluetooth operation is selected in the Source page of the Settings menu.
Can't select Bluetooth Source	<ul style="list-style-type: none">• Check MS-BT200 cable connection• If you are in USA Tuner mode check Bluetooth source is selected Settings→Sources→Accessory →Bluetooth

©2013 by FUSION Electronics Limited. All rights reserved. Product specifications, design and prices are subject to change without notice. FUSION Electronics offers a limited One Year Consumer warranty on this product, for full warranty terms and conditions visit www.fusionelectronics.com. Apple is a trademark of Apple Inc., registered in the U.S and other countries. Android is a trademark of Google Inc. Sirius, XM and all related marks and logo's are trademarks of SiriusXM Radio Inc. All Rights reserved.