

STANDARD HORIZON

ECLIPSE GX1300

25 Watt VHF/FM

Class D DSC Marine Transceiver

Owner's Manual

- Affordable compact class D fixed mount VHF radio
- Submersible IPX8 class (4.92 feet for 30 minutes)
- Meets ITU-R M493-13 class D DSC (Digital Selective Calling)
- Built in Separate Receiver for CH70 (Receiving DSC Calls)
- Programmable soft keys
- Easy to Operate Icon/Menu System
- Oversized Full dot matrix display (31 mm x 55 mm)
- GPS position and time shown* on a full dot matrix display
- DSC distress, individual, group, all ships, position request, position report and DSC test call
- Programmable scan, priority scan, and Multi Watch (Dual Watch or Triple Watch)
- NMEA in and output connections to a compatible GPS chart plotter
- All USA/International and Canadian marine channels
- Preset Key used to recall up to 10 favorite channels
- Automatic poll the GPS position of up to 6 ships using DSC
- NOAA weather channel selection with Weather Alert

* When GPS connected



TABLE OF CONTENTS

Quick Reference Guide	5
1 GENERAL INFORMATION	6
2 PACKING LIST	7
3 OPTIONS	7
4 ONLINE WARRANTY REGISTRATION(in USA or Canada only)	7
5 GETTING STARTED	8
5.1 ABOUT VHF RADIO	8
5.2 SELECTING AN ANTENNA	8
5.2.1 Coaxial Cable	9
5.3 EMERGENCY (CHANNEL 16 USE)	10
5.4 CALLING ANOTHER VESSEL (CHANNEL 16 OR 9)	10
5.5 OPERATING ON CHANNELS 13 AND 67 (USA Channel Group Only)	11
6 INSTALLATION	12
6.1 LOCATION	12
6.2 MOUNTING THE RADIO	12
6.2.1 Supplied Mounting Bracket	12
6.2.2 Optional MMB-84 Flush Mount Bracket	13
6.3 ELECTRICAL CONNECTIONS	14
6.4 ACCESSORY CABLE	16
6.5 CHECKING GPS CONNECTIONS	17
6.6 CHANGING THE GPS TIME	18
6.7 CHANGING THE TIME LOCATION	19
6.8 CHANGING THE TIME FORMAT	20
7 CONTROLS AND INDICATORS	21
7.1 FRONT PANEL	21
7.2 REAR PANEL	23
7.3 MICROPHONE	24
8 BASIC OPERATION	25
8.1 RECEPTION	25
8.2 TRANSMISSION	25
8.3 TRANSMIT TIME-OUT TIMER (TOT)	25
8.4 SIMPLEX/DUPLEX CHANNEL USE	26
8.5 USA, INTERNATIONAL, AND CANADA MODE	26
8.6 NOAA WEATHER CHANNELS	27
8.6.1 NOAA Weather Alert	27
8.6.2 NOAA Weather Alert Testing	27
8.7 SCANNING	28
8.7.1 Selecting the Scan Type	28
8.7.2 Scan Memory Programming	29
8.7.3 Memory Scanning (M-SCAN)	29
8.7.4 Priority Channel Setting	30
8.7.5 Priority Scanning (P-SCAN)	30
8.8 MULTI WATCH (TO PRIORITY CHANNEL)	31
8.8.1 Setting up the Multi Watch Operation	31
8.8.2 Starting the Dual Watch	32
8.9 PRESET CHANNELS: INSTANT ACCESS	33
8.9.1 Preset Channel Programming	33
8.9.2 Operation	33
8.9.3 Deleting a Preset Channel	34
8.10 OPERATION MENU	35

TABLE OF CONTENTS

9	DIGITAL SELECTIVE CALLING	36
9.1	GENERAL.....	36
9.2	MARITIME MOBILE SERVICE IDENTITY (MMSI).....	36
9.2.1	What is an MMSI?	36
9.2.2	Programming the MMSI.....	37
9.3	DSC DISTRESS ALERT.....	38
9.3.1	Transmitting a DSC Distress Alert	38
9.3.2	Receiving a DSC Distress Alert	42
9.4	ALL SHIPS CALL.....	43
9.4.1	Transmitting an All Ships Call	43
9.4.2	Receiving an All Ships Call	44
9.4.3	Setting up the All Ships Call Ringer	45
9.5	INDIVIDUAL CALL.....	46
9.5.1	Setting up the Individual / Position Call Directory	46
9.5.2	Setting up Individual Call Reply	48
9.5.3	Setting up the Individual Call Acknowledge Message	49
9.5.4	Transmitting an Individual Call	50
9.5.5	Receiving an Individual Call.....	52
9.5.6	Setting up the Individual Call Ringer.....	54
9.6	GROUP CALL.....	56
9.6.1	Setting up a Group Call	56
9.6.2	Transmitting a Group Call.....	58
9.6.3	Receiving a Group Call.....	61
9.6.4	Setting up the Group Call Ringer.....	62
9.7	POSITION REQUEST	63
9.7.1	Transmitting a Position Request to Another Vessel	63
9.7.2	Receiving a Position Request.....	66
9.7.3	Setting up the Position Request Ringer.....	67
9.8	POSITION REPORT.....	68
9.8.1	Transmitting a DSC Position Report Call.....	68
9.8.2	Receiving a DSC Position Report Call.....	70
9.8.5	Setting up a Position Report Ringer	71
9.9	MANUAL INPUT OF THE GPS LOCATION (LAT/LON)	72
9.10	AUTO POS POLLING.....	73
9.10.1	Setting up the Polling Call Type.....	73
9.10.2	Setting up the Polling Time Interval	73
9.10.3	Selecting Stations to be Automatically Polled.....	74
9.10.4	Enabling/Disabling Auto POS Polling	75
9.11	DSC TEST CALL.....	76
9.11.1	Transmitting a DSC Test Call	76
9.11.2	Receiving a DSC Test Call	78
9.12	POLLING CALL.....	79
9.12.1	Transmitting a Polling Call	79
9.12.2	Receiving a Polling Call	81
9.13	DSC LOG OPERATION.....	82
9.13.1	Reviewing a Logged Transmitted Call	82
9.13.2	Reviewing a Logged DSC Distress Call	83
9.13.3	Reviewing a Logged Other Calls	84
9.13.4	Deleting Calls from the "DSC LOG" Directory	85

TABLE OF CONTENTS

10	SETUP MENU	87
10.1	CONFIGURATION SETUP	87
10.1.1	Lamp Adjustment	87
10.1.2	LCD Contrast	87
10.1.3	Key Beep	88
10.1.4	Location Format	89
10.1.5	Time Offset	89
10.1.6	Time Display	89
10.1.7	Time Format	89
10.1.8	Unit Of Measure	90
10.1.9	Soft Keys	91
10.2	CHANNEL SETUP	93
10.2.1	Channel Group (Band Selection)	93
10.2.2	Weather Alert	93
10.2.3	Multi Watch	93
10.2.4	Scan Memory	93
10.2.5	Scan Type	94
10.2.6	Scan Resume	94
10.2.7	Priority Channel	94
10.2.8	Sub Channel	94
10.3	DSC SETUP	96
10.3.1	Individual Directory	96
10.3.2	Individual Reply	96
10.3.3	Individual Acknowledgement	96
10.3.4	Individual Ringer	96
10.3.5	Group Directory	97
10.3.6	Auto Position Polling Call Type	97
10.3.7	Auto Position Polling Interval Time	97
10.3.8	Auto Channel Switching Time	98
10.3.9	DSC Beep	98
11	MAINTENANCE	99
11.1	REPLACEMENT PARTS	99
11.2	FACTORY SERVICE	99
11.3	TROUBLESHOOTING CHART	100
12	CHANNEL ASSIGNMENTS	101
13	WARRANTY	107
14	SPECIFICATIONS	111
14.1	GENERAL	111
14.2	TRANSMITTER	111
14.3	RECEIVER	112
14.4	GX1300 DIMENSIONS	113
15	FCC RADIO LICENSE INFORMATION	114
15.1	STATION LICENSE	114
15.2	RADIO CALL SIGN	114
15.3	CANADIAN SHIP STATION LICENSING	114
15.4	FCC / INDUSTRY CANADA INFORMATION	114
16	FCC NOTICE	115
17	RF EXPOSURE SAFETY STATEMENT	116

QUICK REFERENCE GUIDE

- ① Rotate the **VOL** knob clockwise until it clicks to turn on the radio.
- ② Rotate the **VOL** knob to adjust the speaker audio volume.
- ③ Press the **▲** or **▼** key on the radio to select the operating channel.
- ④ Move the **SQL** knob clockwise to squelch or counter clockwise to un-squelch the radio.
- ⑤ Press the **16/S** key on the radio to select Channel 16. Press and hold the **16/S** key on the radio to select the sub channel. Press again to revert to the last selected channel.
- ⑥ Press the **H/L** key to toggle the transmit power between High (25W) and Low (1W).
- ⑦ To transmit: place your mouth about 1" away from the **MIC** hole of the microphone and speak in a normal voice level while pressing the **PTT** switch.
- ⑧ Press the **MENU** key to access the menu list.

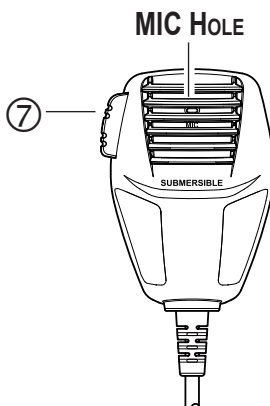
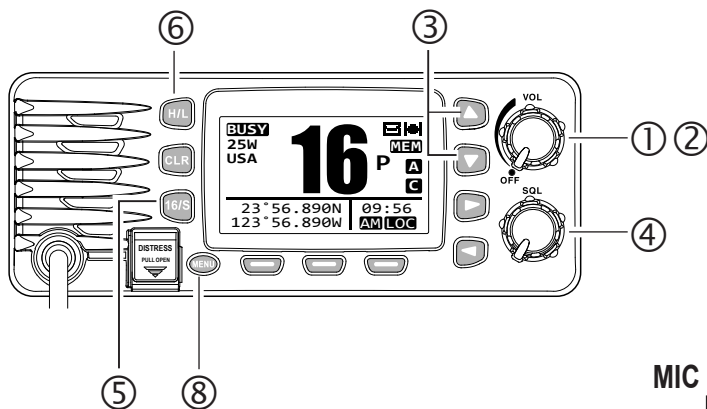

1 GENERAL INFORMATION

The **GX1300 ECLIPSE** is a marine VHF transceiver designed for use in the frequency range of 156.025 to 163.275 MHz. The **GX1300** can be operated from 11 to 16 VDC and has a switchable RF output power of 1 watt or 25 watts.

The **GX1300** is capable of DSC (Digital Selective Calling) Class D (independent Channel 70 receiver) operation which allows continuous receiving of Digital Selective Calling functions on channel 70 even if the radio is receiving a call.

The **GX1300** operates on all currently-allocated marine channels which are switchable for use with either International, USA, or Canadian regulations. It has an emergency channel 16 which can be immediately selected from any channel by pressing the red **16/S** key.

Other features of the transceiver include: scanning, priority scanning, high and low voltage warning, and GPS repeatability.

2 PACKING LIST

When the package containing the transceiver is first opened, please check for the following contents:

- **GX1300** Transceiver
- Mounting Bracket, two Mounting Knobs, and hardware
- Power Cord with 6 Amp fuse and holder
- DSC Sticker
- Flush Mount Template
- Owner's Manual

3 OPTIONS

MMB-84	Flush-Mount Bracket
MLS-310	Amplified External Speaker
MLS-300	External Loudspeaker
HC1100	Dust Cover

4 ONLINE WARRANTY REGISTRATION (in USA or Canada only)

Please visit www.standardhorizon.com to register the **GX1300** Marine VHF. It should be noted that visiting the website from time to time may be beneficial to you, as new products are released they will appear on the STANDARD HORIZON website.

PRODUCT SUPPORT INQUIRIES

If you have any questions or comments regarding the use of the **GX1300**, you can visit the STANDARD HORIZON website to send an E-Mail or contact the Product Support team at (800) 767-2450 M-F 8:00-5:00 PST.

5 GETTING STARTED

5.1 ABOUT VHF RADIO

The radio frequencies used in the VHF marine band lie between 156 and 158 MHz with some shore stations available between 161 and 163 MHz. The marine VHF band provides communications over distances that are essentially “line of sight” (VHF signals do not travel well through objects such as buildings, hills or trees). Actual transmission range depends much more on antenna type, gain and height than on the power output of the transmitter. On a fixed mount 25 W radio transmission expected distances can be greater than 15.5 miles (25 km), for a portable 5 W radio transmission the expected distance can be greater than 5 miles (8 km) in “line of sight”.

5.2 SELECTING AN ANTENNA

Marine antennas are made to radiate signals equally in all horizontal directions, but not straight up. The objective of a marine antenna is to enhance the signal toward the horizon. The degree to which this is accomplished is called the antenna’s gain. It is measured in decibels (dB) and is one of the major factors in choosing an antenna. In terms of effective radiated power (ERP), antennas are rated on the basis of how much gain they have over a theoretical antenna with zero gain. A 3.28 feet (1 m), 3 dB gain antenna represents twice as much gain over the imaginary antenna.

Typically a 3.28 feet (1 m) 3 dB gain stainless steel whip is used on a sailboat mast. The longer 8.2 feet (2.5 m) 6 dB fiberglass whip is primarily used on power boats that require the additional gain.

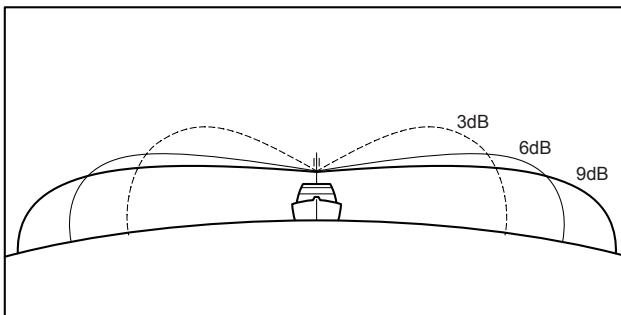

5.2.1 Coaxial Cable

VHF antennas are connected to the transceiver by means of a coaxial cable – a shielded transmission line. Coaxial cable is specified by its diameter and construction.

For runs less than 20 feet (6 m), RG-58/U (about 0.25" (6 mm) in diameter), is a good choice. For runs over 20 feet (6 m) but less than 50 feet (15 m), the larger RG-8X or RG-213/U should be used. For cable runs over 50 feet (15 m) RG-8X should be used. For installation of the connector onto the coaxial cable refer to the figure below.

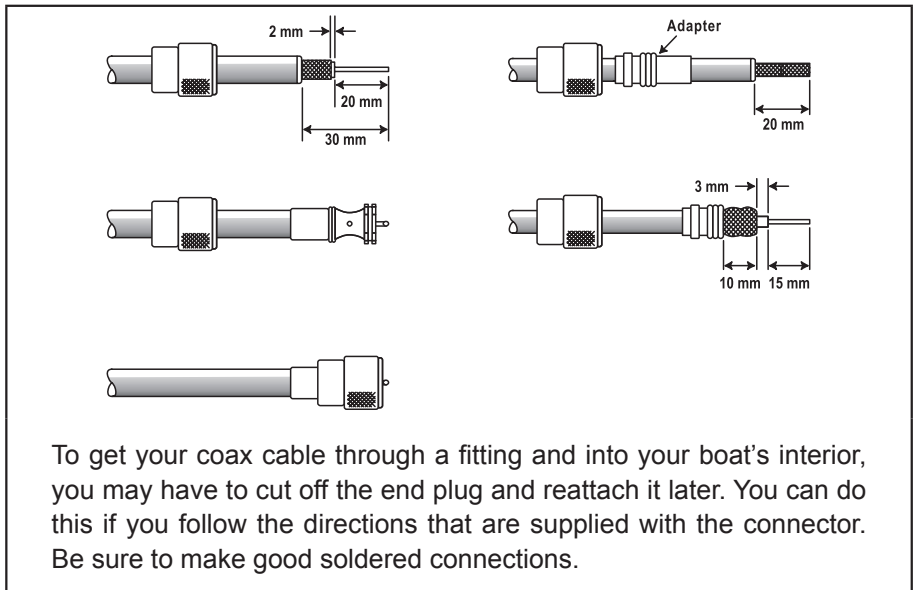

To get your coax cable through a fitting and into your boat's interior, you may have to cut off the end plug and reattach it later. You can do this if you follow the directions that are supplied with the connector. Be sure to make good soldered connections.

5.3 EMERGENCY (CHANNEL 16 USE)

Channel 16 is known as the Hail and Distress Channel. An emergency is defined as a threat to life or property. In such instances, be sure the transceiver is on and set to CHANNEL 16. Then use the following procedure:

1. Press the microphone push-to-talk switch and say "**Mayday, Mayday, Mayday**. This is _____, _____, _____" (your vessel's name).
2. Then repeat once: "**Mayday, _____**" (your vessel's name).
3. Now report your position in latitude/longitude, or by giving a true or magnetic bearing (state which) to a well-known landmark such as a navigation aid or geographic feature such as an island or harbour entry.
4. Explain the nature of your distress (sinking, collision, aground, fire, heart attack, life-threatening injury, etc.).
5. State the kind of assistance you desire (pumps, medical aid, etc.).
6. Report the number of persons aboard and condition of any injured.
7. Estimate the present seaworthiness and condition of your vessel.
8. Give your vessel's description: length, design (power or sail), color and other distinguishing marks. The total transmission should not exceed 1 minute.
9. End the message by saying "**OVER.**" Release the microphone button and listen.
10. If there is no answer, repeat the above procedure. If there is still no response, try another channel.

NOTE

The **GX1300** have DSC Distress calling, that can transmit a distress call digitally to all ships with compatible DSC radios. Refer to section "**9 DIGITAL SELECTIVE CALLING**".

5.4 CALLING ANOTHER VESSEL (CHANNEL 16 OR 9)

Channel 16 may be used for initial contact (hailing) with another vessel.

However, its most important use is for emergency messages. This channel must be monitored at all times except when actually using another channel.

It is monitored by the European, U.S. and Canadian Coast Guards and by other vessels. **Use of channel 16 for hailing must be limited to initial contact only.** Calling should not exceed 30 seconds, but may be repeated 3 times at 2-minute intervals. In areas of heavy radio traffic, congestion on channel 16 resulting from its use as a hailing channel can be reduced significantly in U.S. waters by using **channel 9** as the initial contact (hailing) channel for non-emergency communications. Here, also, calling time should

not exceed 30 seconds but may be repeated 3 times at 2-minute intervals.

Prior to making contact with another vessel, refer to the channel charts in this manual, and select an appropriate channel for communications after initial contact. For example, Channels 68 and 69 are some of the channels available to non-commercial (recreational) boaters. Monitor your desired channel in advance to make sure you will not be interrupting other traffic, and then go back to either channel 16 or 9 for your initial contact.

When the hailing channel (16 or 9) is clear, state the name of the other vessel you wish to call and then **“this is”** followed by the name of your vessel and your Station License (Call Sign). When the other vessel returns your call, immediately request another channel by saying **“go to,”** the number of the other channel, and **“over.”** Then switch to the new channel. When the new channel is not busy, call the other vessel.

After a transmission, say **“over,”** and release the microphone’s push-to-talk (PTT) switch. When all communication with the other vessel is completed, end the last transmission by stating your Call Sign and the word **“out.”** Note that it is not necessary to state your Call Sign with each transmission, only at the beginning and end of the contact.

Remember to return to Channel 16 when not using another channel. Some radios automatically monitor Channel 16 even when set to other channels or when scanning.

5.5 OPERATING ON CHANNELS 13 AND 67 (USA Channel Group Only)

Channel 13 is used at docks, bridges and by vessels maneuvering in port. Messages on this channel must concern navigation only, such as meeting and passing in restricted waters.

Channel 67 is used for navigational traffic between vessels.

By regulation, power is normally limited to 1 Watt on these channels. Your radio is programmed to automatically reduce power to this limit on these channels. However, in certain situations it may be necessary to temporarily use a higher power. See page 23 (H/L key) for means to temporarily override the low-power limit on these two channels.

6 INSTALLATION

6.1 LOCATION

The radio can be mounted at any angle. Choose a mounting location that:

- keeps the radio and microphone at least 3 feet (1 m) away from your vessel's magnetic navigation compass
- provides accessibility to the front panel controls
- allows connection to a power source and an antenna
- has nearby space for installation of a microphone hanger
- the antenna must be mounted at least 3 feet (1 m) from radio

Note: To insure the radio does not affect the compass, or that the radios performance is not affected by the antenna location, temporarily connect the radio in the desired location and:

- a. Examine the compass to see if the radio causes any deviation
- b. Connect the antenna and key the radio. Check to ensure the radio is operating correctly by requesting a radio check.

6.2 MOUNTING THE RADIO

6.2.1 Supplied Mounting Bracket

The supplied mounting bracket allows overhead or desktop mounting.

Use a 0.2" (5.2 mm) bit to drill the holes to a surface which is more 0.4" (10 mm) thick and can support more than 3.3 lb (1.5 kg). Secure the bracket with the supplied screws, spring washers, flat washers, and nuts.

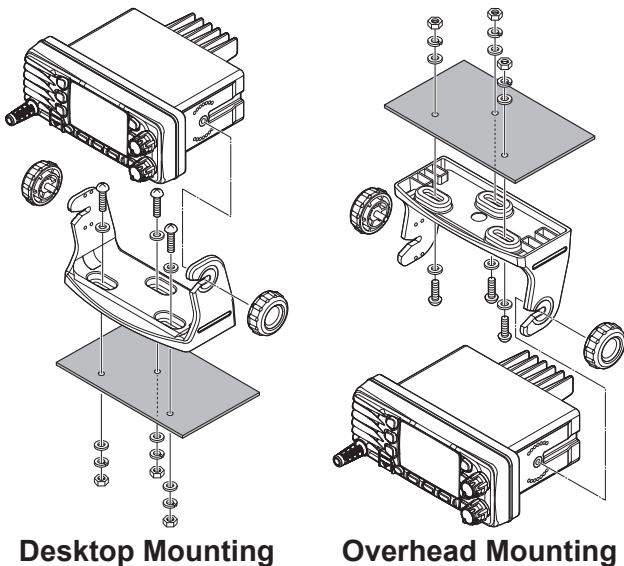

Desktop Mounting

Overhead Mounting

6.2.2 Optional MMB-84 Flush Mount Bracket

1. To assist in flush mounting, a template has been included. Use this template to assess the mounting location.
2. Use the template to mark the location where the rectangular hole is to be cut. Confirm the space behind the dash or panel is deep enough to accommodate the transceiver (at least 5.5" (14 cm) deep). There should be at least 0.5" (1.3 cm) between the transceiver's heat sink and any wiring, cables or structures.
3. Cut out the rectangular hole and insert the transceiver.
4. Fasten the brackets to the sides of the transceiver with the lock washer nut combination, so that the mounting screw base faces the mounting surface.
5. Turn the adjusting screw to adjust the tension so that the transceiver is tight against the mounting surface.

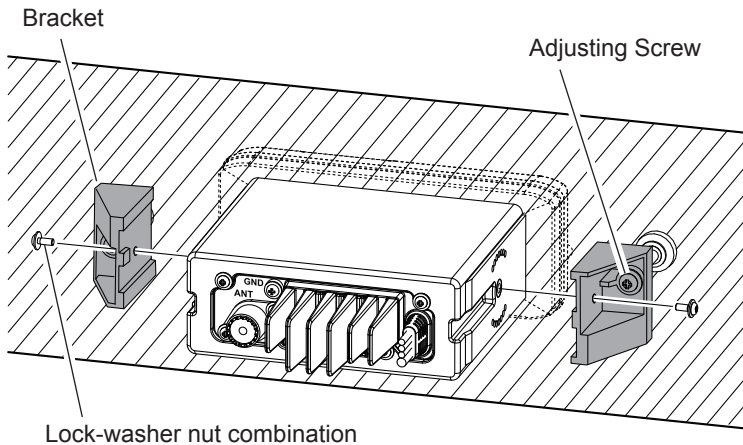

MMB-84 Flush Mount Installation

6.3 ELECTRICAL CONNECTIONS

CAUTION

Reverse polarity connections will damage the radio!

Connect the power cord and antenna to the radio. Antenna and Power Supply connections are as follows (see Figure 1):

1. Mount the antenna at least 3.28 feet (1 m) away from the radio. At the rear of the radio, connect the antenna cable.
2. Connect the red power wire to a 13.8 VDC $\pm 20\%$ power source. Connect the black power wire to a negative ground.
3. If an optional remote extension speaker is to be used, refer to next section for connections.
4. It is advisable to have a Certified Marine Technician check the power output and the standing wave ratio of the antenna after installation.

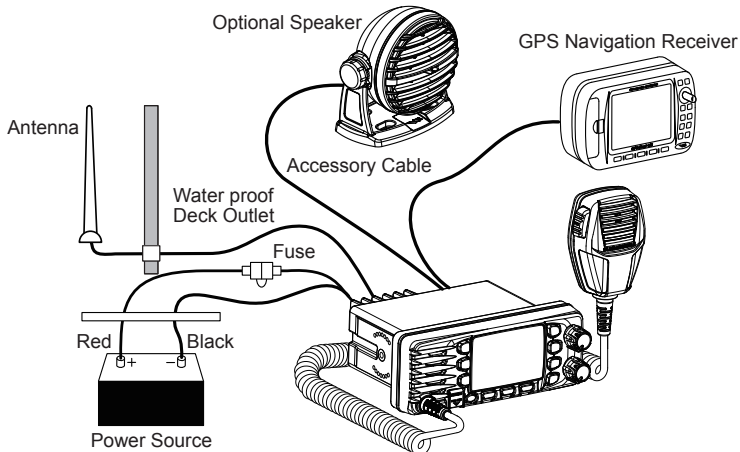
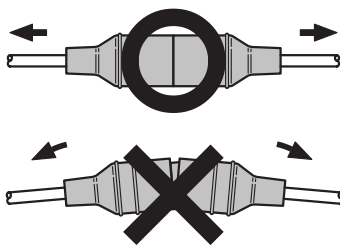

Figure 1. General Installation

Fuse Replacement

To take out the fuse from the fuse holder, hold both ends of the fuse holder and pull the fuse holder apart, do not bend the fuse holder. When you replace the fuse, please confirm that the fuse is tightly fixed on the metal contact located inside the fuse Holder. If the metal contact holding the fuse is loose, the fuse holder may heat up.



6.4 ACCESSORY CABLE

When connecting the external speaker or GPS navigation receiver, strip off about 1" (2.5 cm) of the specified wire's insulation, then splice the ends together using proper waterproofing techniques.

Wire Color/Description	Connection Examples
WHITE - External Speaker (+)	Connect to external 4-ohm audio speaker
SHIELD - External Speaker (-)	Connect to external 4-ohm audio speaker
YELLOW - NMEA GPS Input (+)	Connect to NMEA (+) output of GPS
GREEN - NMEA GPS Input (-)*	Connect to NMEA (-) output or common ground of GPS
WHITE - NMEA DSC Output (+)	Connect to NMEA (+) input of GPS
BROWN - NMEA DSC Output (-)*	Connect to NMEA (-) input of GPS

*: Some GPS chart plotters have a single wire for NMEA signal ground. In such a case connect the NMEA input (-) to the GPS chart plotter's single NMEA signal ground wire, and leave the NMEA output (-) open. In case the assignment of power supply and ground of a GPS chart plotter to be used is different from that of the radio, connect the signal ground wire of the GPS chart plotter to the ground terminal (GND) on the rear panel of the radio.

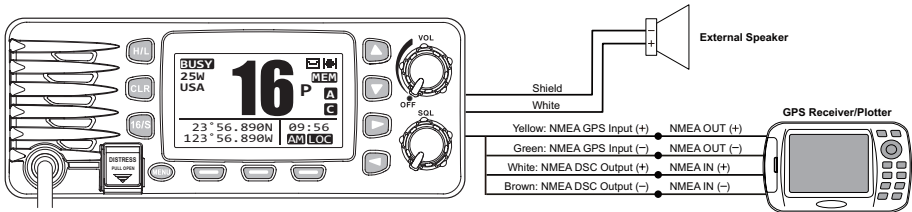

- The GPS must have the NMEA Output turned on and set to 4800 Baud in the SETUP menu. If there is a selection for parity select none.
- For further information on interfacing /setting up your GPS. Please contact the manufacturer of the GPS receiver.
- **GX1300** can read NMEA-0183 version 2.0 or higher.
- The NMEA supported sentences are:
 - Input: GLL, GGA, RMC, GNS, GSA and GSV (RMC sentence is recommended)
 - Output: DSC and DSE

6.5 CHECKING GPS CONNECTIONS

After connections have been made between the **GX1300** and the GPS, a small satellite icon will appear on the top right corner of the display, and displays your current location (Latitude/Longitude) on the display.

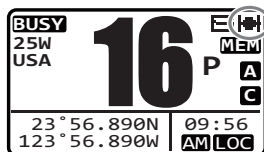

NOTE

- If there is a problem with the NMEA input from a GPS, the satellite icon will blink continuously until the connection is corrected.
- If a GPS with NMEA output is not connected to the radio, the **GX1300** will beep 10 minutes after the radio is turned on. After that the **GX1300** will beep every 4 hours alerting to connect a GPS.

The **GX1300** has a GPS status display which shows the satellites currently being received, along with a graphical (bar-graph) representation of the relative signal strengths from each of the satellites.

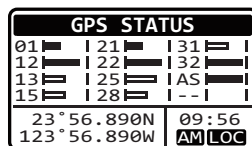

(GPS STATUS DISPLAY)

NOTE

For the **GX1300** to properly show the GPS status page when an external GPS antenna or a chart plotter is connected it must be setup to output GSA and GSV NMEA 0183 sentences.

1. Turn the transceiver on.
2. Press the **MENU** key to display the menu.
3. Select "GPS" with the **▲ / ▼ / ◀ / ▶** key, then press the **SELECT** soft key.
The "GPS STATUS" screen will appear.
4. Press the **CLR** key to return to radio operation.



6.6 CHANGING THE GPS TIME

From the factory the **GX1300** displays GPS satellite time or UTC (Universal Time Coordinated or GMT (Greenwich Mean Time)) time. A time offset is needed to show the local time in your area.

1. Press the **MENU** key to display the menu.
2. Select "SETUP" with the **▲ / ▼ / ◀ / ▶** keys, then press the **SELECT** soft key.
3. Select "CONFIGURATION" with the **▲ / ▼** keys, then press the **SELECT** soft key.
4. Select "TIME OFFSET" with the **▲ / ▼** keys, then press the **SELECT** soft key.
5. Press the **▲ / ▼** keys to select time offset from UTC. See illustration below to find your offset time from UTC. If "00:00" is assigned, the time is the same as UTC.
6. Press the **ENTER** soft key to store the time offset.
7. Press the **BACK** soft key to exit the menu.

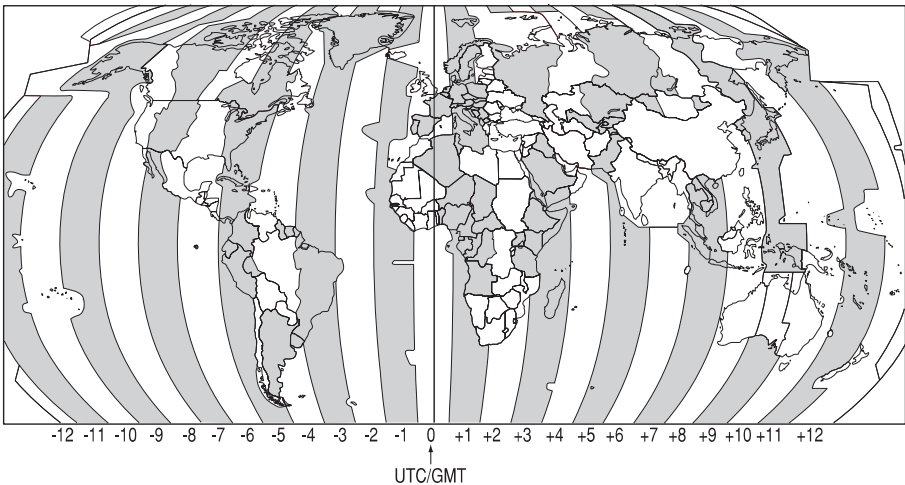
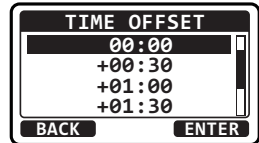
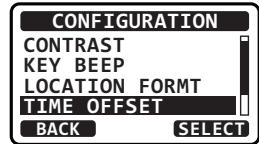
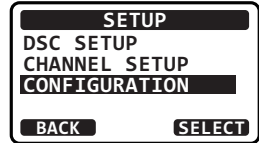

OFFSET TIME TABLE

6.7 CHANGING THE TIME LOCATION

This menu item allows you to choose to show UTC or the local time which is selected in Section 6.6.

1. Press the **MENU** key to display the menu.
2. Select "SETUP" with the **▲ / ▼ / ◀ / ▶** keys, then press the **SELECT** soft key.
3. Select "CONFIGURATION" with the **▲ / ▼** keys, then press the **SELECT** soft key.
4. Select "TIME AREA" with the **▲ / ▼** keys, then press the **SELECT** soft key.
5. Press the **▲ / ▼** to select "UTC" or "LOCAL".
6. Press the **ENTER** soft key to store the selected setting.
7. Press the **BACK** soft key to exit the menu.

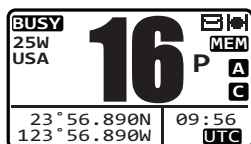
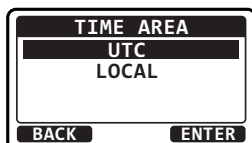
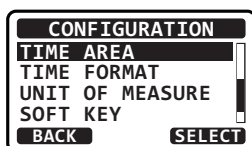
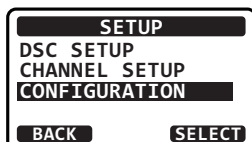

("UTC" mode)

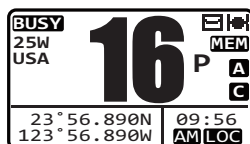

("LOCAL" mode)

6.8 CHANGING THE TIME FORMAT

This menu item allows you to choose to show time in 12-hour or 24-hour format.

1. Press the **MENU** key to display the menu.
2. Select "SETUP" with the **▲ / ▼ / ◀ / ▶** keys, then press the **SELECT** soft key.
3. Select "CONFIGURATION" with the **▲ / ▼** keys, then press the **SELECT** soft key.
4. Select "TIME FORMAT" with the **▲ / ▼** keys, then press the **SELECT** soft key.
5. Press the **▲ / ▼** to select "12 HOURS" or "24 HOURS".
6. Press the **ENTER** soft key to store the selected setting.
7. Press the **BACK** soft key to exit the menu.

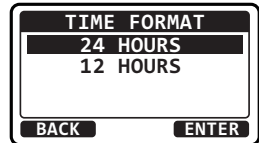
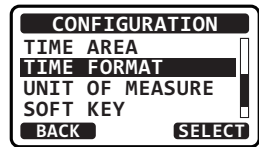
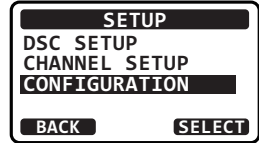

7 CONTROLS AND INDICATORS

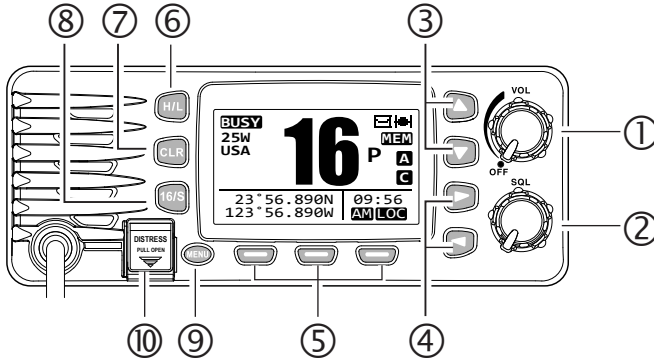

7.1 FRONT PANEL

① Power Switch / Volume Control Knob (VOL)

Turns the transceiver on and off as well as adjusts the audio volume.

Rotate this knob clockwise to turn the radio on and to increase the speaker audio volume level.

To turn the radio off, rotate fully counterclockwise until the pointer stops on the “OFF” indication on the panel.

② Squelch Control Knob (SQL)

Adjusting this control clockwise, sets the point at which random noise on the channel does not activate the audio circuits but a received signal will. This point is called the squelch threshold. Further adjustment of the squelch control will degrade reception of wanted transmissions.

③ ▲ / ▼ Keys

The ▲ and ▼ keys are used to select a desired channel and to select items in the DSC operation and other menu operations.

④ ◀ / ▶ Keys

The ◀ and ▶ keys are used to select items in the DSC operation and other menu operations.

⑤ **Soft Keys**

The 3 programmable soft keys can be customized by the SETUP menu (see the section “**10.1.7 SOFT KEYS**”). When one of the soft keys is pressed briefly, the functions will appear above each key on the display.

The factory defaults are Key 1: **CH/WX**, Key 2: **SCAN**, Key 3: **SCAN MEM**, Key 4: **PRESET** and Key 5: **GPS STATUS** function.

Appropriate functions are automatically assigned to these keys during the menu and the DSC operations.

⑥ **H/L Key**

Press this key to toggle the transmit output power between 25 W (High) and 1 W (Low) power. When the H/L key is pressed while the transceiver is on channel 13 or 67, the power will temporarily switch from LO to HI power until the **PTT** is released.

The H/L key does not function on transmit inhibited and low power only channels.

⑦ **CLR Key**

Immediately recalls the previous selected working channel during the DSC operation and other menu operations.

⑧ **16/S Key**

Immediately recalls channel 16 from any channel location and automatically selects high power. Pressing and holding this key recalls sub channel. Pressing the **16/S** key again reverts to the previous selected working channel.

⑨ **MENU Key**

Press this key to access the menu list. The “DSC”, “GPS”, “MMSI/POS INFO”, and “SETUP” functions can be accessed from the menu.

NOTE

Before the “DSC” menu can be selected an MMSI must be entered. Refer to section “**9.2 MARITIME MOBILE SERVICE IDENTITY (MMSI)**.”

⑩ **DISTRESS Key**

Used to send a DSC Distress Call. To send the distress call refer to section “**9.3.1 Transmitting a DSC Distress Alert**”.

7.2 REAR PANEL

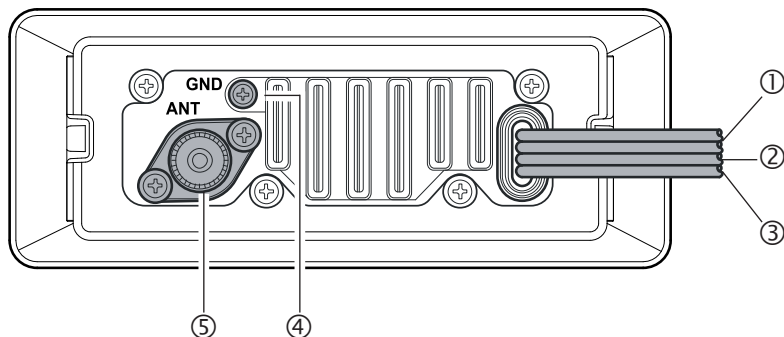

① **DC Input Cable**

Connects the radio to a DC power supply capable of delivering 12V DC.

② **External Speaker Connection Cable**

Connects the **GX1300** to an external speaker.

③ **GPS Receiver Connection Cable**

Connects the **GX1300** to a GPS receiver.

④ **Ground Terminal (GND)**

Connects the **GX1300** to a good ground, for safety and optimum performance.

Normally, the **GND** connection to the heat sink is not needed. However, when the DC power cable connection to the radio has a long run, the transmitter may become unstable and the receiving audio may be noisy. In such a case, connect a large diameter, short cable between this terminal on the heat sink and battery ground.

Install only the supplied screw or similar size (M3x6, Stainless Steel) screw.

⑤ **Antenna Jack (ANT)**

Connects an antenna to the transceiver. Use a marine VHF antenna with an impedance of 50 ohms.

7.3 MICROPHONE

- ① **PTT (Push-To-Talk) Switch**
Keys the transmitter when the transceiver is in radio mode.
- ② **MIC (Microphone) Hole**
Transmits the voice message with reduction of background noise, using Clear Voice Noise Reduction Technology.

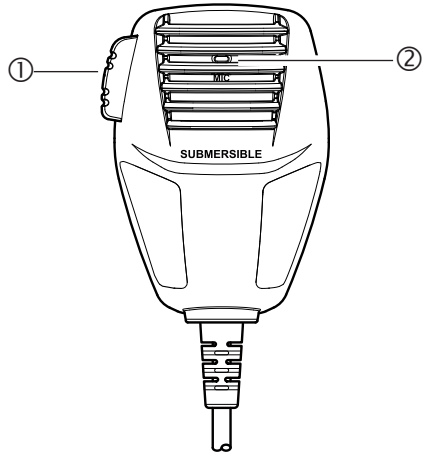

NOTE

Be sure your mouth is about 1" (1.3 cm) from the MIC hole for best performance.

8 BASIC OPERATION

8.1 RECEPTION

1. After the **GX1300** has been installed, ensure that the power supply and antenna are properly connected.
2. Turn the **VOL** knob clockwise until it clicks to turn the transceiver on.
3. Turn the **SQL** knob fully counterclockwise. This state is known as “squelch off”.
4. Turn the **VOL** knob until noise or audio from the speaker is at a comfortable level.
5. Turn the **SQL** knob clockwise until the random noise disappears. This state is known as the “squelch threshold.”
6. Press the **▲** or **▼** keys to select the desired channel. Refer to the channel chart on page 104 for available channels.
7. When a message is received, adjust the volume to the desired listening level with the **VOL** knob. The “**BUSY**” indicator appears on the LCD indicating that the channel is being used.

8.2 TRANSMISSION

1. Perform steps 1 through 6 of RECEPTION.
2. Before transmitting, monitor the channel to ensure it is clear.
THIS IS AN FCC REQUIREMENT!
3. Press and hold the **PTT** (push-to-talk) switch of the microphone. The “**TX**” indicator appears on the LCD.
4. Speak slowly and clearly into the microphone.
5. When the transmission is finished, release the **PTT** switch.

8.3 TRANSMIT TIME-OUT TIMER (TOT)

When the **PTT** switch on the microphone is held down, transmit time is limited to 5 minutes. This limits unintentional transmissions due to a stuck microphone. About 10 seconds before automatic transmitter shutdown, a warning beep will be heard from the speaker(s). The transceiver will automatically go to receive mode, even if the **PTT** switch is continually held down. Before transmitting again, the **PTT** switch must first be released and then pressed again.

NOTE

When a transmission was shut down by the TOT, the **GX1300** can not transmit afterwards for 10 seconds.

8.4 SIMPLEX/DUPLEX CHANNEL USE

Refer to the VHF MARINE CHANNEL CHART (page 104) for instructions on use of simplex and duplex channels.

NOTE

All channels are factory-programmed in accordance with International, Industry Canada (Canada), and FCC (USA) regulations. Mode of operation cannot be altered from simplex to duplex or vice-versa.

8.5 USA, INTERNATIONAL, AND CANADA MODE

To change the channel group from USA to International or Canada:

1. Press the **MENU** key to display the menu.
2. Select "SETUP" with the **▲ / ▼ / ◀ / ▶** keys, then press the **SELECT** soft key.
3. Press the **▲ / ▼** key to select "CHANNEL SETUP", then press the **SELECT** soft key.
4. Press the **▲ / ▼** key to select "CHANNEL GROUP", then press the **SELECT** soft key.
5. Press the **▲ / ▼** key to select desired channel group "USA", "INTL", or "CAN".
6. Press the **ENTER** soft key to store the selected setting.
7. Press the **BACK** soft key to exit the menu.

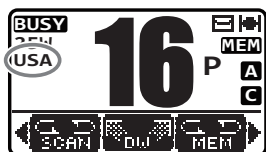
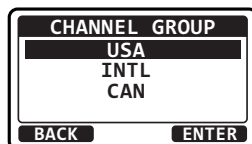
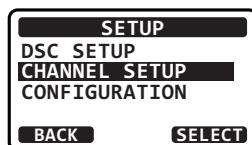
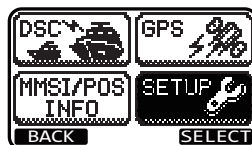

USA Mode

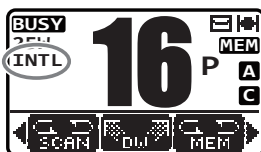

INTERNATIONAL Mode

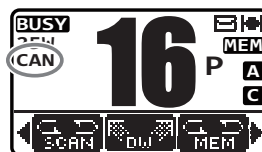

CANADA Mode

Refer to the VHF MARINE CHANNEL CHART (page 104) for allocated channels in each mode.

8.6 NOAA WEATHER CHANNELS

1. To receive a NOAA weather channel, press one of the soft keys, then press the **WX** soft key from any channel. The transceiver will go to the last selected weather channel and the “**WX**” icon appears on the display.
2. Press the Up / Down keys to select a different NOAA weather channel.
3. To exit from the NOAA weather channels, press one of the soft keys, then press the **CH** soft key. The transceiver returns to the channel it was on prior to a weather channel and the “**WX**” icon disappears from the display.

8.6.1 NOAA Weather Alert

In the event of extreme weather disturbances, such as storms and hurricanes, the NOAA (National Oceanic and Atmospheric Administration) sends a weather alert accompanied by a 1050 Hz tone and subsequent weather report on one of the NOAA weather channels.

The **GX1300** can receive weather alerts when on a weather channel and on the last selected weather channel during scanning modes or while on another channel.

When an alert is received on a NOAA weather channel, scanning will stop and the transceiver will emit a loud beep to alert the user of a NOAA broadcast. Press any key to stop the alert and receive the weather report.

To disable the weather alert function, refer to section “**10.2.2 Weather Alert**”.

8.6.2 NOAA Weather Alert Testing

NOAA tests the alert system every Wednesday between 11AM and 1PM. To test the **GX1300**'s NOAA weather feature, on Wednesday between 11AM and 1PM, setup as in section “**8.6.1 NOAA Weather Alert**” and confirm the alert is heard.

8.7 SCANNING

Allows the user to select the scan type from Memory scan or Priority scan. "Memory scan" scans the channels that were programmed into memory. "Priority scan" scans the channels programmed in memory with the priority channel.

8.7.1 Selecting the Scan Type

1. Press the **MENU** key to display the menu.
2. Select "SETUP" with the **▲ / ▼ / ◀ / ▶** keys, then press the **SELECT** soft key.
3. Press the **▲ / ▼** key to select "CHANNEL SETUP", then press the **SELECT** soft key.
4. Select "SCAN TYPE" with the **▲ / ▼** keys, then press the **SELECT** soft key.
5. Press the **▲ / ▼** keys to select "PRIORITY SCAN" or "MEMORY SCAN."
6. Press the **ENTER** soft key to store the selected setting.
7. Press the **BACK** soft key to exit the menu.

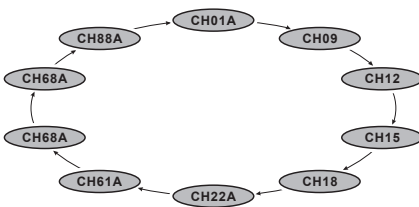
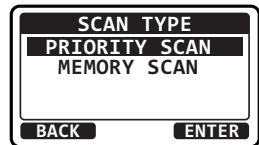
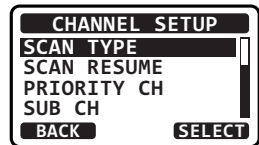
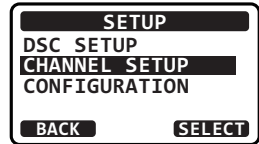

MEMORY SCAN (M-SCAN)

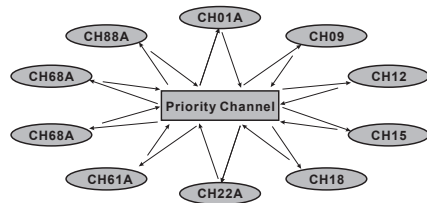

PRIORITY SCAN (P-SCAN)

8.7.2 Scan Memory Programming

1. Press the **MENU** key to display the menu.
2. Select "SETUP" with the **▲ / ▼ / ◀ / ▶** keys, then press the **SELECT** soft key.
3. Press the **▲ / ▼** key to select "CHANNEL SETUP", then press the **SELECT** soft key.
4. Press the **▲ / ▼** key to select "SCAN MEMORY", then press the **SELECT** soft key.
5. Press the **▲ / ▼** key to select a desired channel to be scanned, then press the **MEM** soft key. "MEM" appears on the display, which indicates the channel has been selected to the scan channel.
6. Repeat step 5 for all the desired channels to be scanned.
7. To delete a channel from the list, select the channel then press the **MEM** soft key again. The "MEM" disappears from the display.
8. Press the **BACK** soft key to exit the menu.

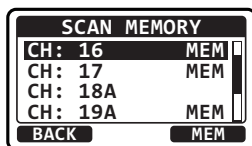
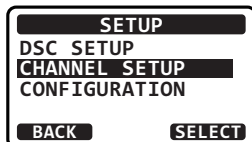
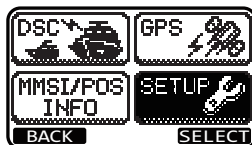

NOTE

Priority Channel can be set for each Channel Group.

8.7.3 Memory Scanning (M-SCAN)

1. Adjust the **SQL** knob until background noise disappears.
2. Select "MEMORY SCAN" as scan type via the SETUP menu.
3. Press one of the soft keys, then press the **SCAN** soft key (it may be necessary to press the **◀ / ▶** key to locate the **SCAN** soft key). "M-SCN" appears on the LCD. Scanning will proceed from the lowest to the highest programmed channel number and will stop on a channel when a transmission is received.
4. The channel number will blink during reception.
5. To stop scanning, press the **16/S** key or press one of the soft keys, then press the **SCAN** soft key.

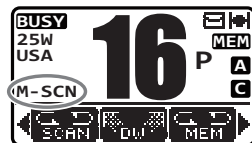

8.7.4 Priority Channel Setting

In the default setting, Channel 16 is set as the priority channel. You may change the priority channel to another channel from Channel 16 via the SETUP menu.

1. Press the **MENU** key to display the menu.
2. Select "SETUP" with the **▲ / ▼ / ◀ / ▶** keys, then press the **SELECT** soft key.
3. Press the **▲ / ▼** key to select "CHANNEL SETUP", then press the **SELECT** soft key.
4. Press the **▲ / ▼** key to select "PRIORITY CH", then press the **SELECT** soft key.
5. Press the **▲ / ▼** keys to select the priority channel.
6. Press the **ENTER** soft key to store the selected setting.
7. Press the **BACK** soft key to exit the menu.

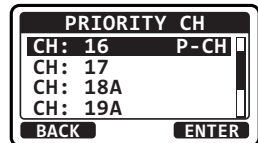
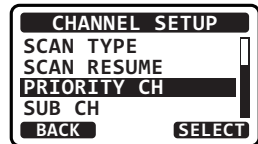
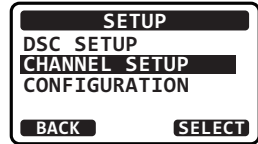

NOTE

Priority Channel can be set for each Channel Group.

8.7.5 Priority Scanning (P-SCAN)

1. Adjust the **SQL** knob until background noise disappears.
2. Select "PRIORITY SCAN" as scan type via the SETUP menu.
3. Press one of the soft keys, then press the **SCAN** soft key (it may be necessary to press the **◀ / ▶** key to locate the **SCAN** soft key). "P-SCN" appears on the LCD. Scanning will proceed between the memorized channels and the priority channel. The priority channel will be scanned after each programmed channel.
4. Scanning will stop on a channel when a transmission is received. The channel number will blink during reception.
5. To stop scanning, press the **16/S** key or press one of the soft keys, then press the **SCAN** soft key.

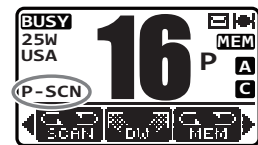

8.8 MULTI WATCH (TO PRIORITY CHANNEL)

Multi watch is used to scan two or three channels for communications.

- In Dual Watch, a normal VHF channel and the priority channel are scanned alternately.
- In Triple Watch, a normal VHF channel, the priority channel, and the sub channel are scanned alternately.

When a signal is received on the normal channel the radio briefly switches between the normal channel and the priority channel to look for a transmission. If the radio receives communications on the priority channel the radio stops and listens to the priority channel until communication ends and then starts dual or triple watch scan again.

8.8.1 Setting up the Multi Watch Operation

1. Press the **MENU** key to display the menu.
2. Select "SETUP" with the **▲ / ▼ / ◀ / ▶** keys, then press the **SELECT** soft key.
3. Press the **▲ / ▼** key to select "CHANNEL SETUP", then press the **SELECT** soft key.
4. Select "MULTI WATCH" with the **▲ / ▼** keys, then press the **SELECT** soft key.
5. Press the **▲ / ▼** keys to select "DUAL" or "TRIPLE."
6. Press the **ENTER** soft key to store the selected setting.
7. Press the **BACK** soft key to exit the menu.

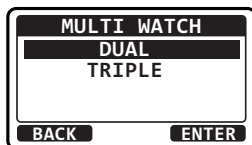
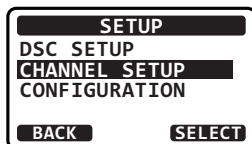
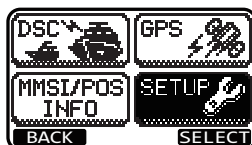

8.8.2 Starting the Dual Watch

1. Adjust the **SQL** knob until the background noise disappears.
2. Select the channel you wish to dual watch to the priority channel.
3. Press one of the soft keys, then press the **DW** soft key (it may be necessary to press the ◀ / ▶ key to locate the **DW** soft key).

“DW - ##” (## indicates the priority channel number you have selected) appears on the LCD. The radio will scan between the priority channel and the channel that was selected in step 2.

If a transmission is received on the channel selected in step 2, the **GX1300** will dual watch to the priority channel.

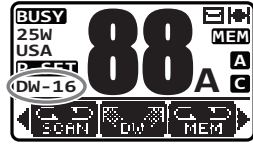

4. To stop dual watch, press one of the soft keys, then press the **DW** soft key again.

When selecting “TRIPLE” in the SETUP menu, **TW** will be displayed as the soft key instead of **DW**.

NOTE

The priority channel may be changed from CH16 to another channel. Refer to section “8.6.4 Priority Channel Setting”.

8.9 PRESET CHANNELS: INSTANT ACCESS

10 preset channels can be programmed for instant access. Pressing the **PRESET** soft key activates the preset channel bank. If the **PRESET** soft key is pressed and no channels have been assigned, an alert beep will be emitted from the speaker.

For details about the assignment of the **PRESET** and other soft keys, see “10.1.7 Soft Keys”.

8.9.1 Preset Channel Programming

1. Press the ▲ / ▼ key to select the channel to be programmed.
2. Press one of the soft keys, then press and hold the **PRESET** soft key until the channel number blinks.
3. Press the **ADD** soft key to program the channel into the preset channel.
The “**P-SET**” icon appears on the LCD.
4. Repeat steps 1 through 3 to program the desired channels into the preset channel bank.

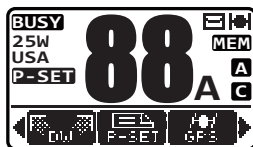
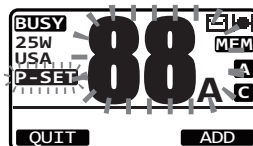
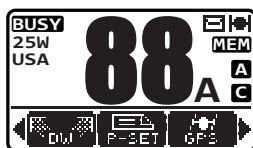

NOTE

Priority Channel can be set for each Channel Group.

8.9.2 Operation

1. Press one of the soft keys, then press the **PRESET** soft key to recall the preset channel.
The “**P-SET**” icon will appear on the LCD.
2. Press the ▲ / ▼ key to select the desired preset channel.
3. Press one of the soft keys, then press the **PRESET** soft key again to return to the last selected channel.

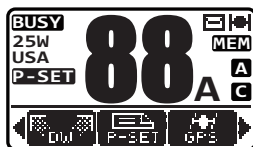

8.9.3 Deleting a Preset Channel

1. Press one of the soft keys, then press the **PRESET** soft key.
2. Press the **▲ / ▼** key to select the preset channel to be deleted.
3. Press one of the soft keys, then press and hold the **PRESET** soft key until the channel number blinks.
4. Press the **DELETE** soft key to delete the channel from the preset channel bank. The “**P-SET**” icon disappears on the LCD.
5. Repeat steps 2 through 4 to delete the desired channels from the preset channel bank.

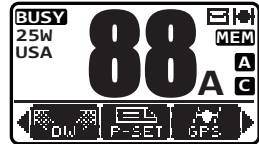
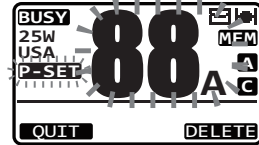

8.10 OPERATION MENU

The **GX1300** provides advanced features below, via the menu screen displayed by pressing the **MENU** key on the front panel.

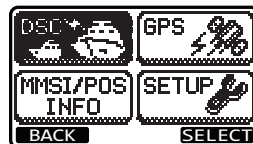

DSC

The following seven types of DSC (Digital Selective Calling) are available: Individual, Group, All Ships, Position Request, Position Report, Polling, and Auto Position Polling.

This menu also provides convenient functions for DSC as below.

- Sets the nature of Distress Call (DIST ALERT MSG)
- Browses information of received DSC calls (DSC LOG)
- Transmits a test call (DSC TEST)

GPS

You can check the signal strength of captured GPS satellites.

MMSI/POS INFO

Via this menu, input your MMSI (Maritime Mobile Service Identity) before you use DSC.

SETUP

This menu allows certain aspects of your transceiver's configuration to be customized for your personal operating conditions.

9 DIGITAL SELECTIVE CALLING

9.1 GENERAL

WARNING

The **GX1300** is designed to generate digital maritime distress and safety calls to facilitate search and rescue. To be effective as a safety device, this equipment must be used only within communication range of a shore-based VHF marine channel 70 distress and safety watch system. The range of signal may vary, however under normal conditions should be approximately 20 nautical miles.

Digital Selective Calling (DSC) is a semi-automated method of establishing a radio call. It has been designated by the International Maritime Organization (IMO) as an international standard for establishing VHF, MF, and HF radio calls. It has also been designated as part of the Global Maritime Distress and Safety System (GMDSS). It is planned that DSC will eventually replace aural watches on distress frequencies and will be used to announce routine and urgent maritime safety information broadcasts.

This system allows mariners to instantly send a distress call with GPS position (when connected to the transceiver) to the Coast Guard and other vessels within range of the transmission. DSC will also allow mariners to initiate or receive Distress, Urgency, Safety, Routine, POSITION REQUEST, POSITION SEND, and Group calls to or from another vessel equipped with a DSC transceiver.

9.2 MARITIME MOBILE SERVICE IDENTITY (MMSI)

9.2.1 What is an MMSI?

An MMSI is a nine digit number used on Marine radios capable of using Digital Selective Calling (DSC). This number is used like a telephone number to selectively call other vessels.

THIS NUMBER MUST BE PROGRAMMED INTO THE RADIO TO OPERATE DSC FUNCTIONS.

How can I obtain an MMSI assignment?

Please contact the Radio Licensing Authority for your country for information on how to obtain an MMSI number.

9.2.2 Programming the MMSI

WARNING

The MMSI can be input only once. Therefore, *please be careful not to input the incorrect MMSI number*. If you need to change the MMSI number after it has been entered, the radio will have to be returned to Factory Service. Refer to the section “12.2 FACTORY SERVICE.”

1. Press the **MENU** key to display the menu.
2. Press the **▲ / ▼** key to select “MMSI/POS INFO”.
3. Press the **SELECT** soft key. (To cancel, press the **BACK** soft key.)
4. Press the **▲ / ▼** key to select the first number of your MMSI, then press the **SELECT** soft key to step to the next number.
5. Repeat step 4 to set your MMSI number (nine digits).
6. If a mistake was made entering in the MMSI number, press the **◀ / ▶** key until the wrong number is highlighted, then press the **▲ / ▼** key to correct the entry and press the **SELECT** soft key.
7. When finished programming the MMSI number, press the **FINISH** soft key. The radio will ask you to input the MMSI number again. Use steps 4 through 6 above.
8. After the second number has been input, press the **FINISH** soft key to store the MMSI.
9. Press the **OK** soft key to return to the “MMSI/POS INFO” screen.
10. Press the **16/S** key or press the **BACK** soft key to return to radio operation mode.

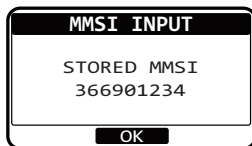
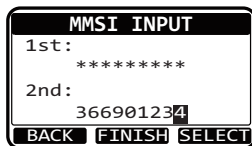
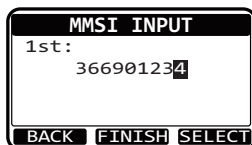
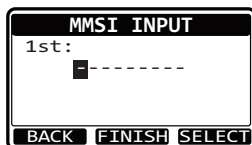
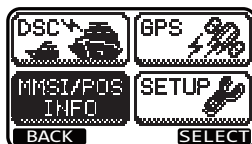

9.3 DSC DISTRESS ALERT

The **GX1300** is capable of transmitting and receiving DSC distress messages to all DSC radios. The **GX1300** may be connected to a GPS to also transmit the latitude and longitude of the vessel.

NOTE

If a GPS with NMEA output is not connected to the radio, the **GX1300** will beep 10 minutes after the radio is turned on and will continue to beep every 4 hours alerting to connect a GPS.

9.3.1 Transmitting a DSC Distress Alert

NOTE

To be able to transmit a DSC distress alert, a MMSI number must be programmed (refer to section “9.2.2 Programming the MMSI”).

In order for your vessel's location to be transmitted, either connect a GPS to the **GX1300** (refer to section “6.4 ACCESSORY CABLE”) or manually input your position (refer to section “9.9 MANUAL INPUTTING OF THE GPS LOCATION”).

Basic Operation

1. Lift the red spring loaded DISTRESS cover, then press and hold the **DISTRESS** key. The “DISTRESS” screen will appear on the LCD and the radios display will count down (3sec → 2sec → 1sec) and then the distress alert will be transmitted. The backlight of the LCD and keypad flashes while the radios display is counting down.
2. The **GX1300** watches for an acknowledgment call on channel 70 or a voice call on channel 16 from another vessel.
3. If an vessel responds to you on channel 16, pick up the microphone and press and hold the **PTT** switch to advise your distress situation.

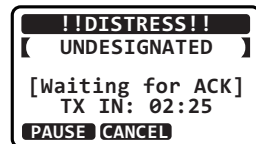
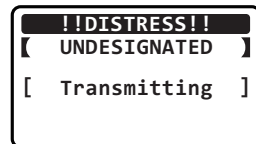
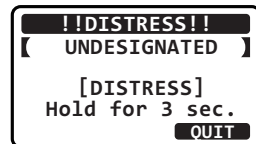

- When a DSC distress acknowledgment is received on channel 70, a DSC distress alarm sounds and channel 16 is automatically selected. Pick up the microphone and press and hold the **PTT** switch to advise your distress situation.

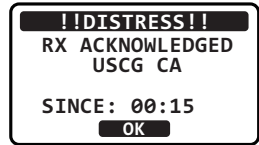

The LCD shows either of the following messages depending on the received acknowledgement:

RX ACKNOWLEDGED: acknowledgment signal is received.

RX RLY ACK: relay acknowledgment signal is received from another vessel or coast station.

To cancel the DSC distress alarm signal from the speaker, press any key.

- If no acknowledgment is received, the distress alert is repeated at approximately 4 minute intervals until a DSC acknowledgment is received.

NOTE

After the radio transmits the distress call, the display of the radio will show the remaining time until the distress call will be re-transmitted. The display will show "TX IN 04:00" and count down.

Transmitting a DSC Distress Alert with Nature of Distress

The **GX1300** is capable of transmitting a DSC distress alert with the following "Nature of Distress" categories:

Undesignated, Fire, Flooding, Collision, Grounding, Capsizing, Sinking, Adrift, Abandoning, Piracy, MOB

- Press the **MENU** key to display the menu.
- Press the **▲ / ▼** keys to select "DSC", then press the **SELECT** soft key.
- Press the **▲ / ▼** keys to select "DIST ALT MSG", then press the **SELECT** soft key. (To cancel, press the **BACK** soft key.)

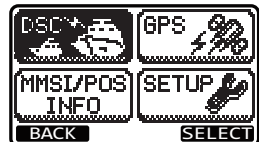

4. Press the **NATURE** soft key.
5. Press the **▲ / ▼** keys to select the desired nature of distress category, then press the **SELECT** soft key.
6. Press and hold the **DISTRESS** key until a distress alert is transmitted.
7. Perform the steps 2 through 5 of the basic operation described in the previous section.

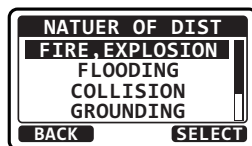
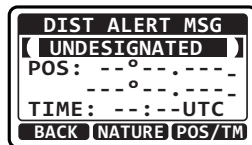

Transmitting a DSC Distress Alert with Manually Entering a Position

When the **GX1300** is not connected to a GPS receiver or the GPS is not operating properly, you may input the latitude/longitude of your vessel manually at your sending of a DSC distress alert.

1. Press the **MENU** key to display the menu.
2. Press the **▲ / ▼** keys to select “DSC”, then press the **SELECT** soft key.
3. Press the **▲ / ▼** keys to select “DIST ALT MSG”, and then press the **SELECT** soft key. (To cancel, press the **BACK** soft key.)

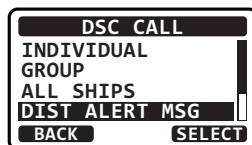

4. Press the **POS/TM** soft key.
5. Enter the latitude/longitude of your vessel and UTC time in the 24-hour format. Press the **▲ / ▼** keys to select the number and press the **SELECT** soft key to move the cursor to the next character. If you make a mistake, press the **◀ / ▶** key until the wrong character is highlighted, then press the **▲ / ▼** key to correct the entry and press the **SELECT** soft key.

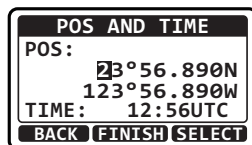
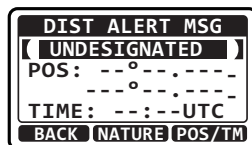

6. When you have completed your selection, press the **FINISH** soft key to save the setting.
7. Press and hold the **DISTRESS** key until a distress alert is transmitted.
8. Perform the steps 2 through 5 of the basic operation described in the previous section.

Pausing a DSC Distress Alert

After a DSC distress call is transmitted, it is repeated every 4 minutes until the call is canceled by the user or until the radio is turned off and on again. The **GX1300** has provision to suspend (pause) the re-transmitting of the distress call by the procedure below.

1. After the distress call is transmitted, the radio will show the display as on the right.
Looking at this display you will notice "TX in 02:25", this is the time when the radio will re-transmit the distress call.
2. To suspend re-transmitting the distress call, press the **PAUSE** soft key.
3. To resume counting down to transmit the distress call, press the **RESUME** soft key.

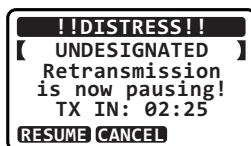
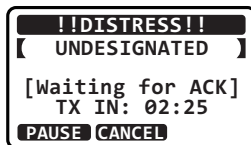

Canceling a DSC Distress Alert

The **GX1300** has the capability to transmit a DSC distress cancel call by pressing the **CANCEL** soft key, then press the **YES** soft key.

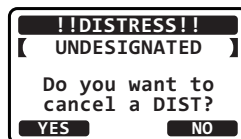
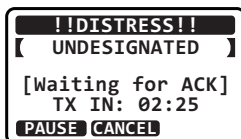

9.3.2 Receiving a DSC Distress Alert

1. When a DSC distress alert is received, an emergency alarm sounds.
The display will show the MMSI (or name) of the vessel transmitting the distress.
2. Press any key on the radio to stop the alarm.
3. To immediately switch to channel 16, press the **ACCEPT** soft key.

If a key is not pressed for thirty seconds (by default; refer to the section “**10.3.8 Auto Channel Switching Time**”) after a DSC call is received, the **GX1300** will automatically switch to channel 16 for you to monitor distress communications.

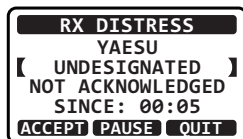

4. Press the **PAUSE** soft key to suspend the acknowledgement.

Press the **RESUME** soft key to resume the acknowledgement.

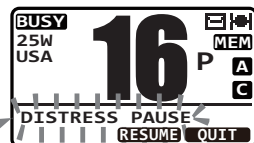

5. If you want the radio to stay on the channel you were on before receiving the distress call, press the **QUIT** soft key.
6. After accepting the distress call, press the **INFO** soft key to show information of the vessel in distress.

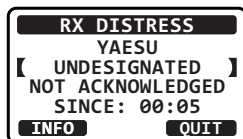

7. Press the **▲ / ▼** keys to scroll the screen and see the MMSI (or name), nature of distress, and GPS position of the vessel in distress.
If the received call does not include position data, the LCD will show “NO POSITION”.

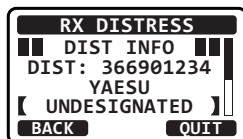

9. Press the **QUIT** soft key to return to radio operation mode.

NOTE

When there is an unread distress alert, “” icon will appear on the display. You may review the unread distress alert from the DSC log, refer to the section “**9.12.2 Reviewing a Logged DSC Distress Call.**”

9.4 ALL SHIPS CALL

The all ships call function allows contact to be established with DSC equipped vessels without having their MMSI in the individual calling directory. Also, priority for the call can be designated as "urgency" or "safety".

URGENCY Call: This type of call is used when a vessel may not truly be in distress, but has a potential problem that may lead to a distress situation. This call is the same as saying "PAN PAN, PAN PAN, PAN PAN" on channel 16.

SAFETY Call: This type of call is used to transmit boating safety information to other vessels. This message usually contains information about an overdue boat, debris in the water, loss of a navigation aid or an important meteorological message. This call is the same as saying "Securite, Securite, Securite."

9.4.1 Transmitting an All Ships Call

1. Press the **MENU** key to display the menu.
2. Press the **▲ / ▼** keys to select "DSC", then press the **SELECT** soft key.
3. Press the **▲ / ▼** keys to select "ALL SHIPS", and then press the **SELECT** soft key. (To cancel, press the **BACK** soft key.)
4. Press the **▲ / ▼** keys to select the category of the call ("SAFETY" or "URGENCY"), then press the **SELECT** soft key.
5. Press the **▲ / ▼** keys to select the operating channel you want to communicate on, then press the **SELECT** soft key.
6. Press the **YES** soft key to transmit the selected type of all ships call.

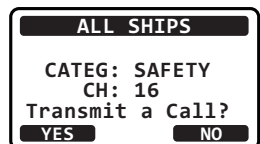
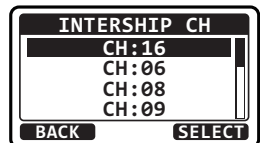
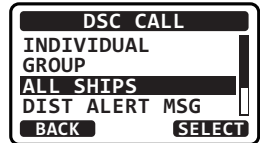

- After the all ships call is transmitted, the transceiver will switch to the channel which selected on the step 5 above, with no change of the display. To change the display, press the **QUIT** soft key.

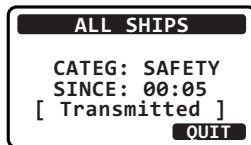

- Listen to the channel to make sure it is not busy, then key the microphone and say “PAN PAN, PAN PAN, PAN PAN” or “Securite, Securite, Securite” depending on the priority of the call. Say your call sign and announce the channel you wish to switch to for communications.

9.4.2 Receiving an All Ships Call

- When an all ships call is received, an emergency alarm sounds. The display will show the MMSI (or name) of the vessel transmitting the all ships call.

- Press any key on the radio to stop the alarm.
- To immediately switch to requested channel, press the **ACCEPT** soft key.

If a key is not pressed for thirty seconds (by default; refer to the section “**10.3.8 Auto Channel Switching Time**”) after an all ships call is received, the **GX1300** will automatically switch to the requested channel for you to monitor communications.

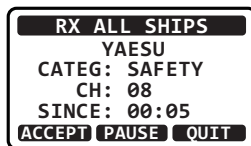

- Press the **PAUSE** soft key to suspend the acknowledgement.

Press the **RESUME** soft key to resume the acknowledgement.

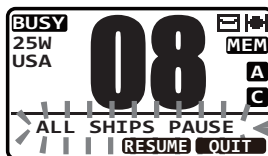

- If you want the radio to stay on the channel you were on before receiving the all ships call, press the **QUIT** soft key.

- Press the **▲ / ▼** keys to scroll the screen and see the MMSI (or name) of the calling vessel, category of the call and requested operating channel.

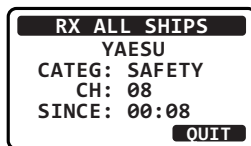

- Press the **QUIT** soft key to display the operating channel number of the requested channel.

- Press the **PTT** switch on the microphone and talk to the calling vessel.

9.4.3 Setting up the All Ships Call Ringer

The **GX1300** has the capability to turn off the all ships call ringer.

1. Press the **MENU** key to display the menu.
2. Press the **▲ / ▼** keys to select “SETUP”, then press the **SELECT** soft key.
3. Press the **▲ / ▼** keys to select “DSC SETUP”, then press the **SELECT** soft key. (To cancel, press the **BACK** soft key.)



4. Select “DSC BEEP” with the **▲ / ▼** keys, then press the **SELECT** soft key.

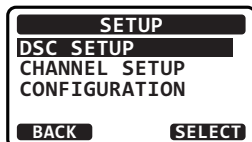

5. Select “ALL SHIPS” with the **▲ / ▼** keys, then press the **SELECT** soft key.

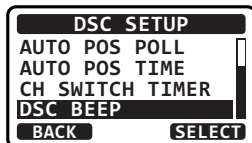

6. Press the **▲ / ▼** keys to select “OFF”, then press the **ENTER** soft key.

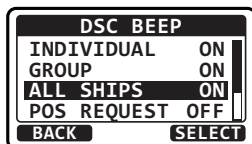

7. Press the **16/S** key or press the **BACK** soft key to return to radio operation mode.

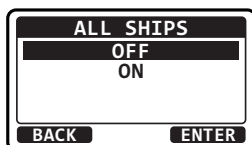

If you wish to return to enabling the ringer tone, just repeat the above procedure, pressing the **▲ / ▼** keys to select “ON” in step 6 above.

9.5 INDIVIDUAL CALL

This feature allows the **GX1300** to contact another vessel with a DSC VHF radio and automatically switch the receiving radio to a desired communications channel. This feature is similar to calling a vessel on CH16 and requesting to go to another channel (switching to the channel is private between the two stations).

9.5.1 Setting up the Individual / Position Call Directory

The **GX1300** has a DSC directory that allows you to store a vessel or person's name and the MMSI (Maritime Mobile Service Identity Number) number associated with vessels you wish to transmit individual calls, position requests and position report transmissions. The **GX1300** can store up to 60 individual MMSI numbers with vessel's or person's names.

To transmit an Individual call you must program this directory with the information of the persons you wish to call, similar to a cellular phones directory.

1. Press the **MENU** key to display the menu.
2. Press the **▲ / ▼** keys to select "SETUP", then press the **SELECT** soft key.
3. Press the **▲ / ▼** keys to select "DSC SETUP", then press the **SELECT** soft key. (To cancel, press the **BACK** soft key.)

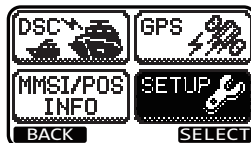

4. Select "INDIVIDUAL DIR." with the **▲ / ▼** keys, then press the **SELECT** soft key.

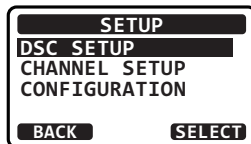

5. Select "ADD" with the **▲ / ▼** keys, then press the **SELECT** soft key.

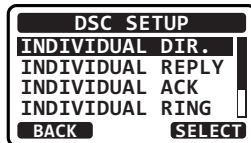

6. Select "NAME" with the **▲ / ▼** keys, then press the **SELECT** soft key.

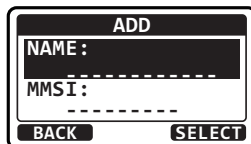
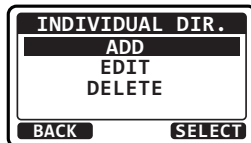

7. Press the ▲ / ▼ keys to scroll to the first letter of the name of the vessel or person you want to list in the directory.



8. Press the **SELECT** soft key to store the first letter of the name and step to the next letter to the right.

9. Repeat steps 7 and 8 until the name is complete.

Press the ► key to move to the next space if you want to enter a blank space in the name.

If a mistake was made entering in the name, press the ◀ / ▶ keys repeatedly until the wrong letter is highlighted, then press the ▲ / ▼ keys to correct the entry.

10. After the twelfth letter or space has been entered, press the **FINISH** soft key to return to the previous screen.

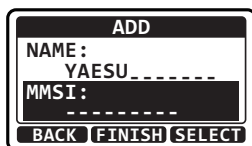

11. Select "MMSI" with the ▲ / ▼ keys, then press the **SELECT** soft key.

12. Press the ▲ / ▼ keys to scroll through numbers, 0 to 9.



13. Press the **SELECT** soft key to store the number and step to the next digit to the right.

14. Repeat steps 12 and 13 until the MMSI is complete.

If a mistake was made entering in the MMSI number, press the ◀ / ▶ keys repeatedly until the wrong number is highlighted, then press the ▲ / ▼ keys to correct the entry.

15. After the ninth number has been entered, press the **FINISH** soft key to return to the previous screen.

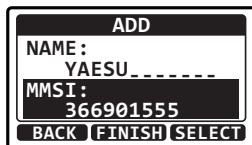

16. Press the **FINISH** soft key to save the entered address.

17. To enter another individual address, repeat steps 5 through 16.

18. Press the **16/S** key or press the **BACK** soft key to return to radio operation mode.

9.5.2 Setting up Individual Call Reply

Allows setting up the radio to automatically (default setting) or manually respond to a DSC individual call requesting you to switch to a working channel for voice communications. When the manual response is selected the MMSI of the calling vessel is shown allowing you to see who is calling. This function is similar to caller ID on a cellular phone.

1. Press the **MENU** key to display the menu.
2. Press the **▲ / ▼** keys to select “SETUP”, then press the **SELECT** soft key.
3. Press the **▲ / ▼** keys to select “DSC SETUP”, then press the **SELECT** soft key. (To cancel, press the **BACK** soft key.)



4. Press the **▲ / ▼** keys to select “INDIVIDUAL REPLY”, then press the **SELECT** soft key.

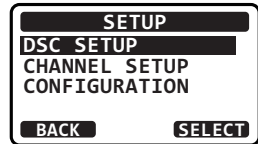

5. Press the **▲ / ▼** keys to select “AUTO” or “MANUAL”, then press the **ENTER** soft key.

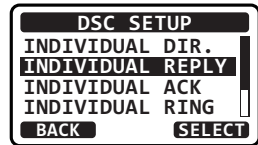

6. Press the **16/S** key or press the **BACK** soft key to return to radio operation mode.

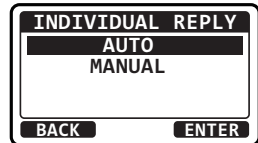

9.5.3 Setting up the Individual Call Acknowledge Message

The **GX1300** can select either reply message “Able” (default) or “Unable” when the individual reply setting (described previous section) is set to “AUTO”.

1. Press the **MENU** key to display the menu.
2. Press the **▲ / ▼** keys to select “SETUP”, then press the **SELECT** soft key.
3. Press the **▲ / ▼** keys to select “DSC SETUP”, then press the **SELECT** soft key. (To cancel, press the **BACK** soft key.)



4. Press the **▲ / ▼** keys to select “INDIVIDUAL ACK”, then press the **SELECT** soft key.

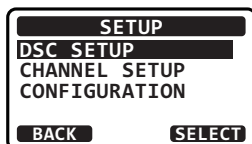

5. Press the **▲ / ▼** keys to select “ABLE” or “UNABLE”, then press the **ENTER** soft key.

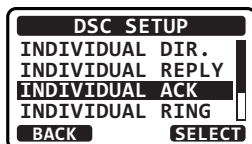

6. Press the **16/S** key or press the **BACK** soft key to return to radio operation mode.

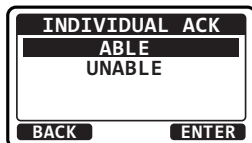

9.5.4 Transmitting an Individual Call

This feature allows you to contact another vessel, switch their radio to a requested working channel and ring like a telephone. This feature is similar to calling a vessel on CH16 and requesting to go to another channel.

Individual Call from Individual / Position Call Directory

1. Press the **MENU** key to display the menu.
2. Press the **▲ / ▼** keys to select “DSC”, then press the **SELECT** soft key.
3. Press the **▲ / ▼** keys to select “INDIVIDUAL”, and then press the **SELECT** soft key. (To cancel, press the **BACK** soft key.)

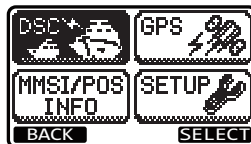

4. Press the **▲ / ▼** keys to select “HISTORY” or “MEMORY”, then press the **SELECT** soft key.

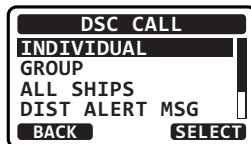

5. Press the **▲ / ▼** keys to select an individual you want to contact, then press the **SELECT** soft key.

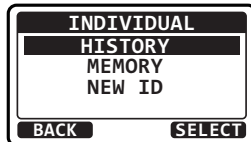

6. Press the **▲ / ▼** keys to select the operating channel you want to communicate on and press the **SELECT** soft key.

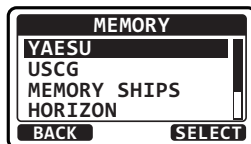

7. Press the **YES** soft key to transmit the individual DSC signal.

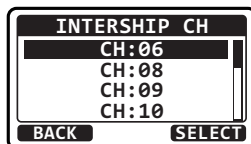

8. After an individual call is transmitted, if the reply signal is not received, “Waiting for ACK” is shown on the display which means the **GX1300** is waiting for the vessel you called to send an acknowledgement.

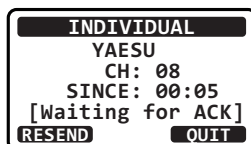
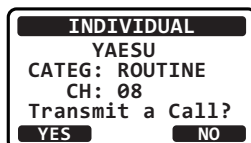

To transmit the call again, press the **RESEND** soft key.

9. When the **GX1300** receives an acknowledgement from the vessel you called, the radio will automatically switch to the operating channel selected in step 6 and produce a ringing sound.
10. Key the microphone and call the other vessel you desire to communicate with.

Individual Call - Manual MMSI Entry

You may enter an MMSI number manually to contact a vessel without storing the MMSI in the individual/position call directory.

1. Press the **MENU** key to display the menu.
2. Press the **▲ / ▼** keys to select “DSC”, then press the **SELECT** soft key.
3. Press the **▲ / ▼** keys to select “INDIVIDUAL”, and then press the **SELECT** soft key. (To cancel, press the **BACK** soft key.)



4. Press the **▲ / ▼** keys to select “NEW ID”, then press the **SELECT** soft key.

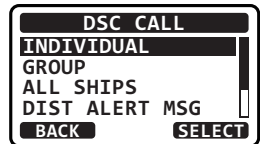

5. Press the **▲ / ▼** keys to scroll through numbers, 0 to 9.
6. Press the **SELECT** soft key to store the number and step to the next digit to the right.

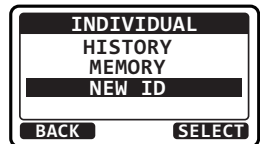

7. Repeat steps 5 and 6 until the MMSI is complete.
If a mistake was made entering in the MMSI number, press the **◀ / ▶** keys repeatedly until the wrong number is highlighted, then press the **▲ / ▼** keys to correct the entry.



8. After the ninth number has been entered, press the **FINISH** soft key.
9. Press the **▲ / ▼** keys to select the operating channel you want to communicate on and press the **SELECT** soft key.

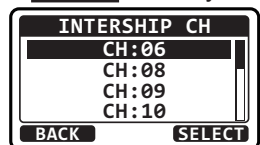

10. Press the **YES** soft key to transmit the individual DSC signal.

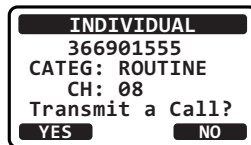

11. After an individual call is transmitted, if the reply signal is not received, “Waiting for ACK” is shown on the display which means the **GX1300** is waiting for the vessel you called to send an acknowledgement. To transmit the call again, press the **RESEND** soft key.
12. When the **GX1300** receives an acknowledgement from the vessel you called, the radio will automatically switch to the operating channel selected in step 9 and produce a ringing sound.
13. Key the microphone and call the other vessel you desire to communicate with.

9.5.5 Receiving an Individual Call

When receiving an individual call, an acknowledgment must be sent back to the calling station. The **GX1300** in the default setting will automatically respond to the calling station and switch to the requested channel for voice communications. Refer to the section “**9.5.2 Setting up Individual Call Reply**” if you want to change the setting to see who is calling before replying to the call.

Automatic reply:

1. When an individual call is received, a ringing alarm sounds. The **GX1300** automatically switches to the requested channel. The display shows the MMSI or the name of the vessel transmitting the individual call.
2. Press any key to stop the alarm.
3. Press the **QUIT** soft key to return to radio operation.
4. Monitor the channel to make sure it is clear, then press the **PTT** switch on the microphone and talk to the calling vessel.

Manual reply:

1. When an individual call is received, a ringing alarm sounds. The display shows the MMSI or the name of the vessel transmitting the individual call.
2. Press any key to stop the alarm.

3. Press the **ACCEPT** soft key to accept the call.

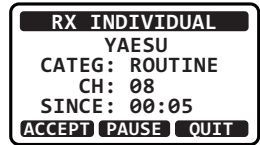

4. Press the **PAUSE** soft key to suspend the acknowledgement.
Press the **RESUME** soft key to resume the acknowledgement.



5. After accepting the call, press the **ABLE** soft key to switch to the requested channel. (To inform that you cannot respond, press the **UNABLE** soft key.)

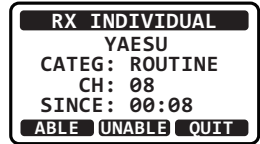

6. Press the **YES** soft key to send an acknowledgement.
Press the **CHG CH** soft key to change the channel for communication from the requested one.

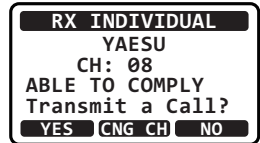

7. After sending the acknowledgement, the **GX1300** switches to the requested channel or to the channel selected in step 6, without changing the display. To change the display, press the **QUIT** soft key.

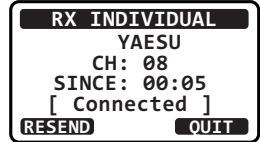

8. Monitor the channel to make sure it is clear, then press the **PTT** switch on the microphone and talk to the calling vessel.

9.5.6 Setting up the Individual Call Ringer

When an individual call is received the radio will produce a ringing tone for 2 minutes (by default). This selection allows the individual call ringer time to be changed.

1. Press the **MENU** key to display the menu.
2. Press the **▲ / ▼** keys to select “SETUP”, then press the **SELECT** soft key.
3. Press the **▲ / ▼** keys to select “DSC SETUP”, then press the **SELECT** soft key. (To cancel, press the **BACK** soft key.)



4. Select “INDIVIDUAL RING” with the **▲ / ▼** keys, then press the **SELECT** soft key.
5. Press the **▲ / ▼** keys to select ringing time of an individual call, then press the **ENTER** soft key.

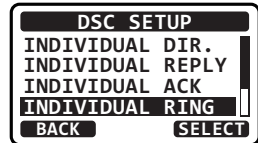
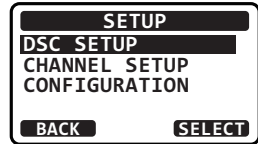

6. Press the **16/S** key or press the **BACK** soft key to return to radio operation mode.

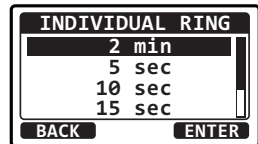

The **GX1300** has the capability to turn off the individual call ringer.

1. Press the **MENU** key to display the menu.
2. Press the **▲ / ▼** keys to select “SETUP”, then press the **SELECT** soft key.
3. Press the **▲ / ▼** keys to select “DSC SETUP”, then press the **SELECT** soft key. (To cancel, press the **BACK** soft key.)

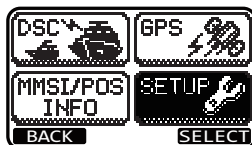

4. Select “DSC BEEP” with the **▲ / ▼** keys, then press the **SELECT** soft key.

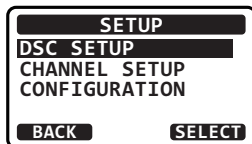

5. Select “INDIVIDUAL” with the **▲ / ▼** keys, then press the **SELECT** soft key.

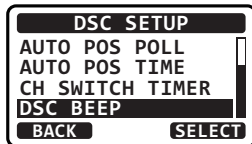

6. Press the **▲ / ▼** keys to select “OFF”, then press the **ENTER** soft key.

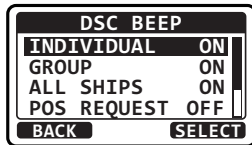

7. Press the **16/S** key or press the **BACK** soft key to return to radio operation mode.

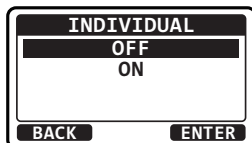

If you wish to return to enabling the ringer tone, just repeat the above procedure, pressing the **▲ / ▼** keys to select “ON” in step 6 above.

9.6 GROUP CALL

This feature allows the user to contact a group of specific vessels (example members of a yacht club) with a group MMSI number using the group call function to automatically switch to a desired channel for voice communications. This function is very useful for yacht clubs and vessels traveling together that want to collectively make announcements on a predetermined channel. The **GX1300** can store up to 20 group call entries.

9.6.1 Setting up a Group Call

For this function to operate the same group MMSI must be programmed into all the DSC VHF radios within the group of vessels that will be using this feature. To understand about group MMSI programming, first a Ship MMSI has to be understood.

Ship MMSI: The first three digits called a MID (Mobile Identity Group) of a ship MMSI denote the country the ship registered for a MMSI. The last 6 digits are specific to the ships ID. *Ship MMSI Example:* If your MMSI is “366123456”, “366” is MID which denote the country and “123456” is the ships ID for you.

Group MMSI:

- Group MMSI numbers are not assigned by the FCC or other organizations licensed to assign ship MMSI numbers.
- The first digit of a group MMSI is always set to “0” by the international rules. All Standard Horizon radios are preset so when programming a group MMSI the first digit is set to “0”.
- The USCG recommends programming the MID of a ships MMSI into the second, third and fourth digits of the group MMSI as it denotes the area the ship is located in.
- The last 5 digits are decided upon by persons in the group. This is an important step as all radios in the group must contain the same group MMSI so they can be contacted by each other. There is a chance that another group of vessels may program in the same group MMSI. If this happens, simply change one or more of the last 5 digits of the group MMSI.

1. Press the **MENU** key to display the menu.
2. Press the **▲ / ▼** keys to select “SETUP”, then press the **SELECT** soft key.
3. Press the **▲ / ▼** keys to select “DSC SETUP”, then press the **SELECT** soft key. (To cancel, press the **BACK** soft key.)



4. Select “GROUP DIR.” with the **▲ / ▼** keys, then press the **SELECT** soft key.

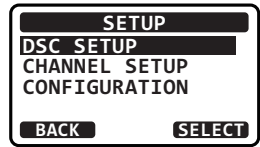

5. Select “ADD” with the **▲ / ▼** keys, then press the **SELECT** soft key.

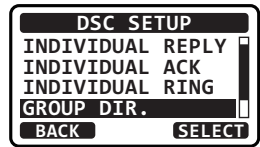

6. Select “NAME” with the **▲ / ▼** keys, then press the **SELECT** soft key.



7. Press the **▲ / ▼** keys to scroll through the first letter of the group name you want to reference in the directory.
8. Press the **SELECT** soft key to store the first letter in the name and step to the next letter to the right.
9. Repeat steps 7 and 8 until the name is complete.

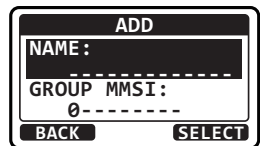

Press the **▶** key to move to the next space if you want to enter a blank space in the name.

If a mistake was made entering in the name, press the **◀ / ▶** keys repeatedly until the wrong letter is highlighted, then press the **▲ / ▼** keys to correct the entry.

10. After the twelfth letter or space has been entered, press the **FINISH** soft key to return to the previous screen.



11. Select “GROUP MMSI” with the ▲ / ▼ keys, then press the **SELECT** soft key.

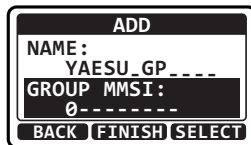

12. Press the ▲ / ▼ keys to scroll through numbers, 0 to 9.
13. Press the **SELECT** soft key to store the number and step to the next digit to the right.

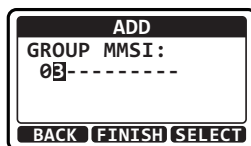

14. Repeat steps 12 and 13 until the group MMSI is complete.
If a mistake was made entering in the MMSI number, press the ◀ / ▶ keys repeatedly until the wrong number is highlighted, then press the ▲ / ▼ keys to correct the entry.

15. After the ninth number has been entered, press the **FINISH** soft key to return to the previous screen.

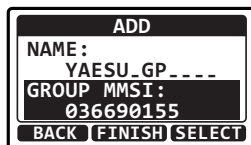

16. Press the **FINISH** soft key to save the entered data.
17. To enter another group entry, repeat steps 5 through 16.
18. Press the **16/S** key or press the **BACK** soft key to return to radio operation mode.

9.6.2 Transmitting a Group Call

Group Call from Group Call Directory

1. Press the **MENU** key to display the menu.
2. Press the ▲ / ▼ keys to select “DSC”, then press the **SELECT** soft key.
3. Press the ▲ / ▼ keys to select “GROUP”, and then press the **SELECT** soft key. (To cancel, press the **BACK** soft key.)



4. Press the ▲ / ▼ keys to select “HISTORY” or “MEMORY”, then press the **SELECT** soft key.

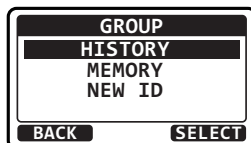
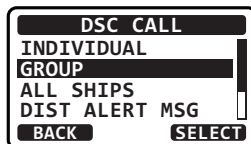

5. Press the ▲ / ▼ keys to select a group you want to contact, then press the **SELECT** soft key.

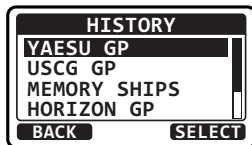

6. Press the ▲ / ▼ keys to select the operating channel you want to communicate on and press the **SELECT** soft key.

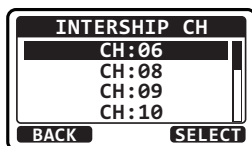

7. Press the **YES** soft key to transmit the group call signal.

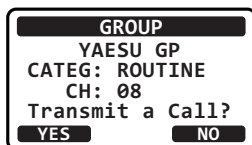

8. After the group call is transmitted, the transceiver will switch to the channel selected in step 6 above, without changing the display. To change the display, press the **QUIT** soft key.

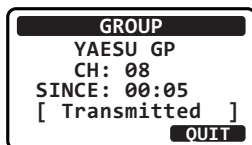

9. Listen to the channel to make sure it is not busy, then key the microphone and call the other vessels you desire to communicate with.

Group Call - Manual Group MMSI Entry

You may enter an MMSI number manually to contact a vessel without storing the MMSI in the Group Call Directory.

1. Press the **MENU** key to display the menu.
2. Press the ▲ / ▼ keys to select “DSC”, then press the **SELECT** soft key.
3. Press the ▲ / ▼ keys to select “INDIVIDUAL”, and then press the **SELECT** soft key. (To cancel, press the **BACK** soft key.)



4. Press the ▲ / ▼ keys to select “NEW ID”, then press the **SELECT** soft key.

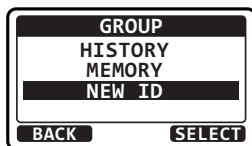
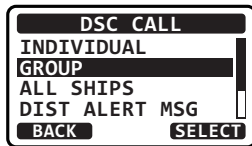

5. Press the ▲ / ▼ keys to scroll through numbers, 0 to 9.
6. Press the **SELECT** soft key to store the number and step to the next digit to the right.

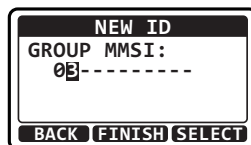

7. Repeat steps 5 and 6 until the MMSI is complete.
If a mistake was made entering in the MMSI number, press the ◀ / ▶ keys repeatedly until the wrong number is highlighted, then press the ▲ / ▼ keys to correct the entry.
8. After the ninth number has been entered, press the **FINISH** soft key.
9. Press the ▲ / ▼ keys to select the operating channel you want to communicate on and press the **SELECT** soft key.

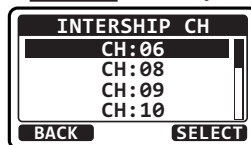

10. Press the **YES** soft key to transmit the group call signal.

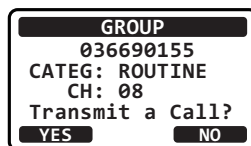

11. After the group call is transmitted, the transceiver will switch to the channel selected in step 9, without changing the display. To change the display, press the **QUIT** soft key.
12. Listen to the channel to make sure it is not busy, then key the microphone and call the other vessels you desire to communicate with.

9.6.3 Receiving a Group Call

1. When a group call is received, the **GX1300** will produce a ringing alarm sound. (DSC BEEP needs to be enabled to hear alarm.)

The display will show the MMSI (or name) of the vessel transmitting the group call.

2. Press any key to stop the alarm.
3. To immediately switch to requested channel, press the **ACCEPT** soft key.

If a key is not pressed for thirty seconds after a group call is received, the **GX1300** will automatically switch to the requested channel for you to monitor communications.

4. Press the **PAUSE** soft key to suspend the acknowledgement.

Press the **RESUME** soft key to resume the acknowledgement.

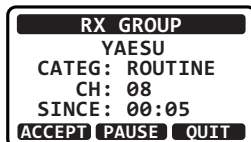

5. If you want the radio to stay on the channel you were on before receiving the group call, press the **QUIT** soft key.

6. Press the **▲ / ▼** keys to scroll the screen and see the MMSI (or name) of the calling vessel, category of the call and requested operating channel.

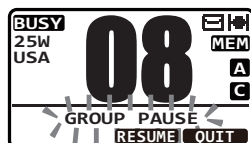

7. Press the **QUIT** soft key to display the operating channel number of the requested channel.

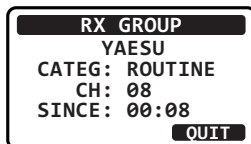

8. Listen to the channel for the person calling the group for a message.
9. If you want to respond, monitor the channel to make sure it is clear, then press the **PTT** switch on the microphone and talk to the calling ship(s).

NOTE

- When there is an unread group call, the "✉" icon will appear on the display. You may review the unread group call from the DSC log, refer to section "9.12.3 Reviewing a Logged Other Calls."
- After a group call is received, the time the call was made and the ships MMSI or vessels name will appear on the LCD.

9.6.4 Setting up the Group Call Ringer

The **GX1300** has the capability to turn off the group call ringer.

1. Press the **MENU** key to display the menu.
2. Press the **▲ / ▼** keys to select “SETUP”, then press the **SELECT** soft key.
3. Press the **▲ / ▼** keys to select “DSC SETUP”, then press the **SELECT** soft key. (To cancel, press the **BACK** soft key.)



4. Select “DSC BEEP” with the **▲ / ▼** keys, then press the **SELECT** soft key.

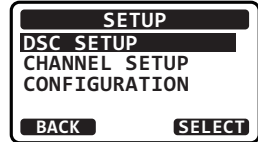

5. Select “GROUP” with the **▲ / ▼** keys, then press the **SELECT** soft key.

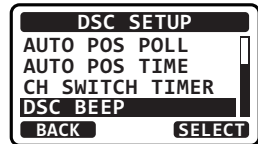

6. Press the **▲ / ▼** keys to select “OFF”, then press the **ENTER** soft key.

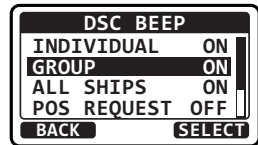

7. Press the **16/S** key or press the **BACK** soft key to return to radio operation mode.

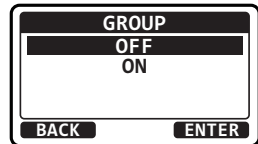

If you wish to return to enabling the ringer tone, just repeat the above procedure, pressing the **▲ / ▼** keys to select “ON” in step 6 above.

9.7 POSITION REQUEST

Advancements in DSC have made it possible to poll the location of another vessel and show the position of that vessel on the display of the **GX1300**. Standard Horizon has taken this feature one step further, if any Standard Horizon GPS is connected to the **GX1300**, the polled position of the vessel is shown on the display of the GPS chart plotter making it easy to navigate to the location of the polled vessel. This is a great feature for anyone wanting to know the position of another vessel. For example your friend that is catching fish, or finding the location of a person you are cruising with.

NOTE

The other vessel must have an operating GPS receiver connected to its DSC transceiver and must not have its transceiver set to deny position requests. (Refer the section “**9.5.1 Setting up the Individual / Position Call Directory**” to enter information into the individual directory).

9.7.1 Transmitting a Position Request to Another Vessel

Position Request from Individual / Position Call Directory

1. Press the **MENU** key to display the menu.
2. Press the **▲ / ▼** keys to select “DSC”, then press the **SELECT** soft key.
3. Press the **▲ / ▼** keys to select “POS REQUEST”, and then press the **SELECT** soft key. (To cancel, press the **BACK** soft key.)



4. Press the **▲ / ▼** keys to select “HISTORY” or “MEMORY”, then press the **SELECT** soft key.

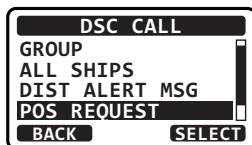

5. Press the **▲ / ▼** keys to select an individual you want to contact, then press the **SELECT** soft key.

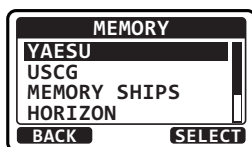

6. Press the **YES** soft key to transmit the position request call.



7. If the **GX1300** does not receive a reply, the display will be as shown in the illustration on the right. To send again, press the **RESEND** soft key.

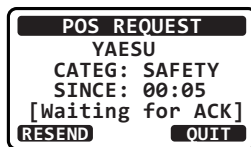

8. When the **GX1300** receives the position from the polled vessel, the **GX1300** will produce a ringing alarm sound and the position from the polled vessel is sent to a GPS chart plotter via NMEA 0183. (DSC BEEP needs to be enabled to hear alarm.)

Press any key to stop the alarm.

9. Press the **INFO** soft key to show the position data transferred from the polled vessel on the display.

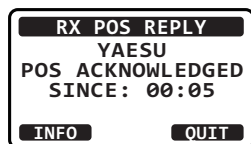

10. Press the **▲ / ▼** keys to change the display to view the received data.

11. To exit from position request display, press the **QUIT** soft key.s

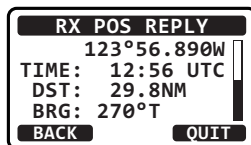
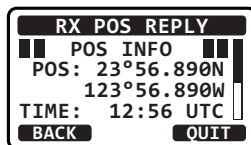

NOTE

If the **GX1300** does not receive position data from the polled vessel, the position and time of LCD will show "--".

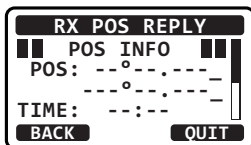

Position Request - Manual MMSI Entry

You may enter an MMSI number manually to contact a vessel without storing the MMSI in the individual/position call directory.

1. Press the **MENU** key to display the menu.
2. Press the **▲ / ▼** keys to select “DSC”, then press the **SELECT** soft key.
3. Press the **▲ / ▼** keys to select “POS REQUEST”, and then press the **SELECT** soft key.
(To cancel, press the **BACK** soft key.)



4. Press the **▲ / ▼** keys to select “NEW ID”, then press the **SELECT** soft key.



5. Press the **▲ / ▼** keys to scroll through numbers, 0 to 9.
6. Press the **SELECT** soft key to store the number and step to the next digit to the right.



7. Repeat steps 5 and 6 until the MMSI is complete.

If a mistake was made entering in the MMSI number, press the **◀ / ▶** keys repeatedly until the wrong number is highlighted, then press the **▲ / ▼** keys to correct the entry.



8. After the ninth number has been entered, press the **FINISH** soft key.
9. Press the **YES** soft key to transmit the position request call.

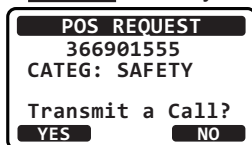

10. If the **GX1300** does not receive a reply, the display will be as shown in the illustration on the right. To send again, press the **RESEND** soft key.

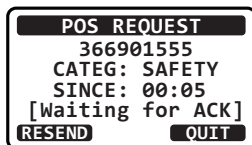

11. When the **GX1300** receives the position from the polled vessel, the **GX1300** will produce a ringing alarm sound and the position from the polled vessel is sent to a GPS chart plotter via NMEA 0183. (DSC BEEP needs to be enabled to hear alarm.)

Press any key to stop the alarm.

12. Press the **INFO** soft key to show the position data transferred from the polled vessel on the display.

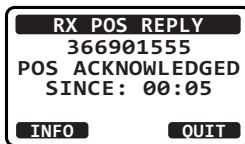

13. Press the **▲ / ▼** keys to change the display to view the received data.

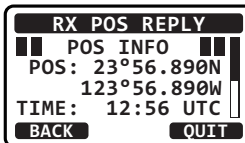

14. To exit from position request display, press the **QUIT** soft key.

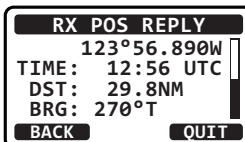

NOTE

If the **GX1300** does not receive position data from the polled vessel, the LCD will show "NO POSITION DATA".

9.7.2 Receiving a Position Request

When a position request call is received from another vessel, a ringing alarm will sound and "POS REQUEST" will be shown in the LCD.

1. When a position request call is received, the **GX1300** will transmit your position to the vessel who requested it.

2. To exit from position request display, press the **QUIT** soft key.

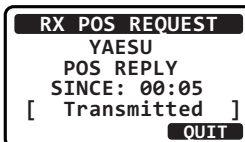

9.7.3 Setting up the Position Request Ringer

The **GX1300** has the capability to turn off the position request ringer.

1. Press the **MENU** key to display the menu.
2. Press the **▲ / ▼** keys to select "SETUP", then press the **SELECT** soft key.
3. Press the **▲ / ▼** keys to select "DSC SETUP", then press the **SELECT** soft key. (To cancel, press the **BACK** soft key.)

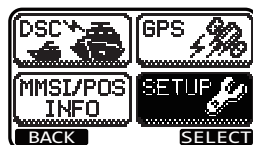

4. Select "DSC BEEP" with the **▲ / ▼** keys, then press the **SELECT** soft key.

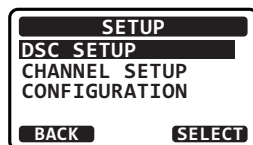

5. Select "POS REQUEST" with the **▲ / ▼** keys, then press the **SELECT** soft key.

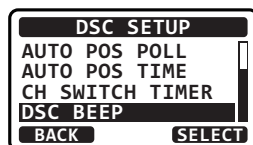

6. Press the **▲ / ▼** keys to select "OFF", then press the **ENTER** soft key.

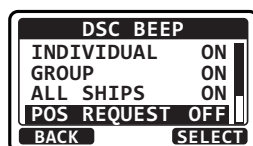

7. Press the **16/S** key or press the **BACK** soft key to return to radio operation mode.

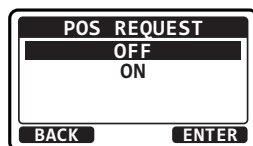

If you wish to return to enabling the ringer tone, just repeat the above procedure, pressing the **▲ / ▼** keys to select "ON" in step 6 above.

9.8 POSITION REPORT

The feature is similar to the position request, however instead of requesting a position of another vessel this function allows you to send your position to another vessel. In order to send your position you need to have a GPS receiver connected or to have manually input your position. See section “9.9 MANUAL INPUTTING OF THE GPS LOCATION.”

9.8.1 Transmitting a DSC Position Report Call

Position Report from Individual / Position Call Directory

1. Press the **MENU** key to display the menu.
2. Press the **▲ / ▼** keys to select “DSC”, then press the **SELECT** soft key.
3. Press the **▲ / ▼** keys to select “POS REPORT”, and then press the **SELECT** soft key. (To cancel, press the **BACK** soft key.)

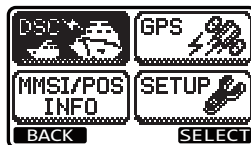

4. Press the **▲ / ▼** keys to select “HISTORY” or “MEMORY”, then press the **SELECT** soft key.

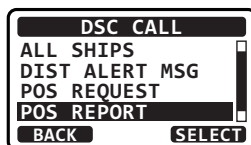

5. Press the **▲ / ▼** keys to select an individual you want to contact, then press the **SELECT** soft key.

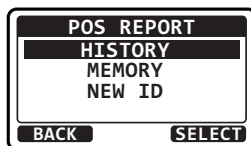

6. Press the **YES** soft key to send your position to the selected vessel.
Press the **POS** soft key to change the position information.

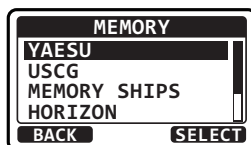

7. To exit from position request display, press the **QUIT** soft key.

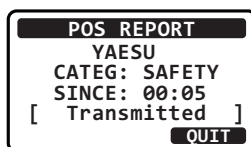
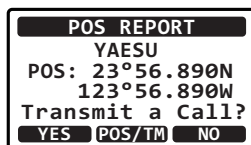

Position Report - Manual MMSI Entry

You may enter an MMSI number manually to contact a vessel without storing the MMSI in the individual/position call directory.

1. Press the **MENU** key to display the menu.
2. Press the **▲ / ▼** keys to select “DSC”, then press the **SELECT** soft key.
3. Press the **▲ / ▼** keys to select “POS REPORT”, and then press the **SELECT** soft key. (To cancel, press the **BACK** soft key.)



4. Press the **▲ / ▼** keys to select “NEW ID”, then press the **SELECT** soft key.

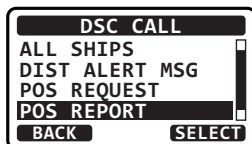

5. Press the **▲ / ▼** keys to scroll through numbers, 0 to 9.
6. Press the **SELECT** soft key to store the number and step to the next digit to the right.

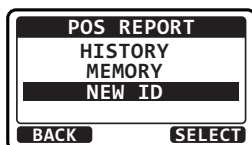

7. Repeat steps 5 and 6 until the MMSI is complete.

If a mistake was made entering in the MMSI number, press the **◀ / ▶** keys repeatedly until the wrong number is highlighted, then press the **▲ / ▼** keys to correct the entry.

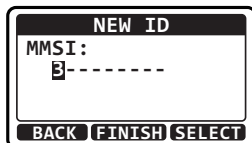

8. After the ninth number has been entered, press the **FINISH** soft key.

9. Press the **YES** soft key to send your position to the selected vessel.

Press the **POS** soft key to change the position information.

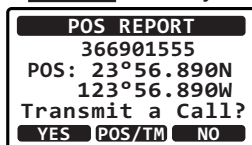

10. To exit from position request display, press the **QUIT** soft key.

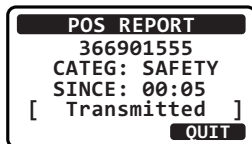

9.8.2 Receiving a DSC Position Report Call

When another vessel transmits their location to the **GX1300** the following will happen:

1. When the position report call is received, a ringing sound will be produced and the display shows the vessels MMSI or name, how long since the call was received and the GPS position of the vessel. The **GX1300** will also output NMEA sentences (DSC and DSE) to a connected GPS chart plotter.
2. Press any key on the radio to stop the alarm. (DSC BEEP needs to be enabled to hear alarm.)
3. Press the **INFO** soft key to show the position data transferred from the calling vessel.
4. Press the **▲ / ▼** keys to change the display to view the received data.
5. To exit from position request display, press the **QUIT** soft key.

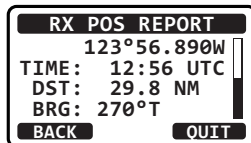
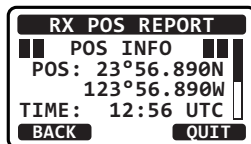
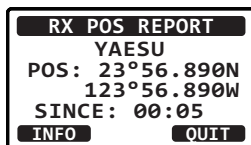

9.8.5 Setting up a Position Report Ringer

The **GX1300** has the capability to turn off the position report ringer.

1. Press the **MENU** key to display the menu.
2. Press the **▲ / ▼** keys to select “SETUP”, then press the **SELECT** soft key.
3. Press the **▲ / ▼** keys to select “DSC SETUP”, then press the **SELECT** soft key. (To cancel, press the **BACK** soft key.)



4. Select “DSC BEEP” with the **▲ / ▼** keys, then press the **SELECT** soft key.

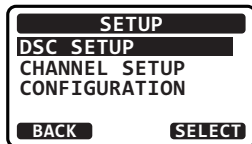

5. Select “POS REPORT” with the **▲ / ▼** keys, then press the **SELECT** soft key.

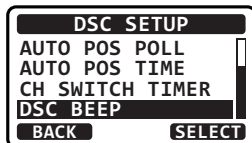

6. Press the **▲ / ▼** keys to select “OFF”, then press the **ENTER** soft key.

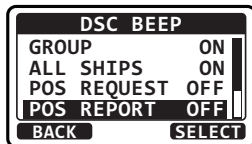

7. Press the **16/S** key or press the **BACK** soft key to return to radio operation mode.

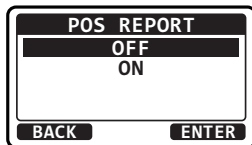

To enable the position report ringer, repeat the above procedure, pressing the **▲ / ▼** keys to select “ON” in step 7 above.

9.9 MANUAL INPUT OF THE GPS LOCATION (LAT/LON)

You may send the latitude and longitude of your vessel manually when a GPS receiver is not connected or is not functioning.

After the position is entered, transmitting a DSC distress or position report will contain the manually entered position.

1. Press the **MENU** key to display the menu.
2. Press the **▲ / ▼** key to select "MMSI/POS INFO".
3. Press the **SELECT** soft key. (To cancel, press the **BACK** soft key.)
4. Press the **POS/TM** soft key to display the position input screen.
5. Press the **▲ / ▼** key to select the first digit of your latitude, then press the **SELECT** soft key to step to the next digit.
6. Repeat step 5 to enter your latitude and longitude.
7. Enter UTC time in the 24-hour format with the same procedure in step 5.
8. If a mistake was made entering in the position and time, press the **◀ / ▶** key until the wrong letter is highlighted, then press the **▲ / ▼** key to correct the entry and press the **SELECT** soft key.
9. When finished programming the position information, press the **FINISH** soft key.
10. Press the **OK** soft key to return to the menu screen.
Press the **POS/TM** soft key to display the position input screen again.
11. Press the **16/S** key or press the **BACK** soft key to return to radio operation mode.

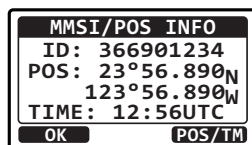
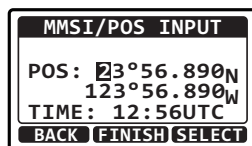
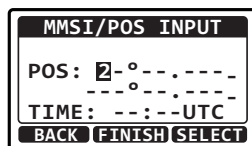
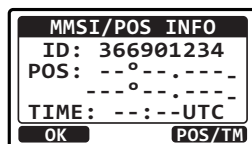
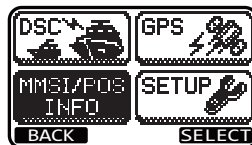

9.10 AUTO POS POLLING

The **GX1300** has the capability to automatically track four stations programmed into the individual directory.

9.10.1 Setting up the Polling Call Type

1. Press the **MENU** key to display the menu.
2. Press the **▲ / ▼** keys to select "SETUP", then press the **SELECT** soft key.
3. Press the **▲ / ▼** keys to select "DSC SETUP", then press the **SELECT** soft key. (To cancel, press the **BACK** soft key.)
4. Select "AUTO POS POLL" with the **▲ / ▼** keys, then press the **SELECT** soft key.
5. Press the **▲ / ▼** keys to select "POS REQUEST" or "POS REPORT", then press the **ENTER** soft key.
6. Press the **BACK** soft key to return to "DSC SETUP".

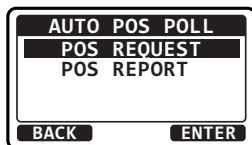
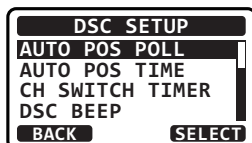
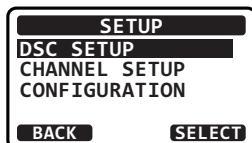
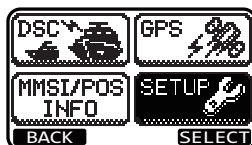

9.10.2 Setting up the Polling Time Interval

1. Press the **MENU** key to display the menu.
2. Press the **▲ / ▼** keys to select "SETUP", then press the **SELECT** soft key.
3. Press the **▲ / ▼** keys to select "DSC SETUP", then press the **SELECT** soft key. (To cancel, press the **BACK** soft key.)

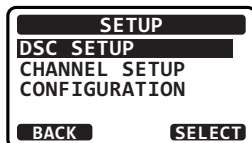
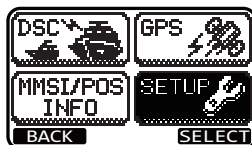

- Select "AUTO POS TIME" with the ▲ / ▼ keys, then press the **SELECT** soft key.

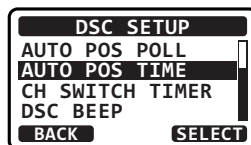

- Press the ▲ / ▼ keys to select the desired interval time, then press the **ENTER** soft key.

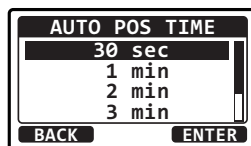

- Press the **16/S** key or press the **BACK** soft key to return to radio operation mode.

9.10.3 Selecting Stations to be Automatically Polled

- Press the **MENU** key to display the menu.
- Press the ▲ / ▼ keys to select "DSC", then press the **SELECT** soft key.
- Press the ▲ / ▼ keys to select "AUTO POS POLLING", and then press the **SELECT** soft key. (To cancel, press the **BACK** soft key.)

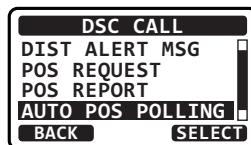

- Press the ▲ / ▼ keys to select "SELECT ID", then press the **SELECT** soft key.

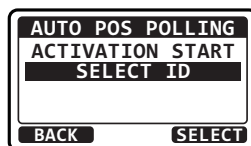

- Press the ▲ / ▼ keys to select the list number, then press the **SELECT** soft key.

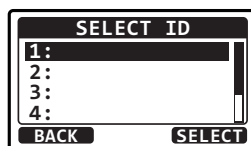

- Press the ▲ / ▼ keys to select an individual you want to poll, then press the **SELECT** soft key.

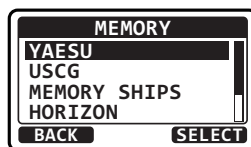

- Repeat steps 5 and 6 for all the desired individual to be polled.

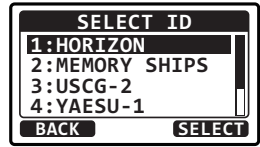

- Press the **BACK** soft key to return to “AUTO POS POLLING”.

9.10.4 Enabling/Disabling Auto POS Polling

- Press the **MENU** key to display the menu.
- Press the **▲ / ▼** keys to select “DSC”, then press the **SELECT** soft key.
- Press the **▲ / ▼** keys to select “AUTO POS POLLING”, and then press the **SELECT** soft key. (To cancel, press the **BACK** soft key.)



- Press the **▲ / ▼** keys to select “ACTIVATION START”, then press the **SELECT** soft key.

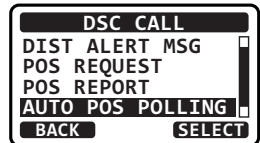

- Press the **▲ / ▼** keys to select “START”, then press the **SELECT** soft key.

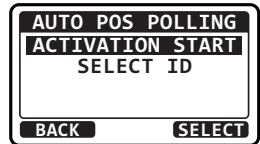

- Press the **16/S** key or press the **BACK** soft key to return to radio operation mode.



To disable the auto position polling, repeat the above procedure, pressing the **▲ / ▼** keys to select “STOP” in step 5 above.

The “A” indicator will appear on the LCD while the auto position polling is activated.

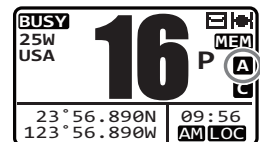

9.11 DSC TEST CALL

This function is used to contact another DSC equipped vessel to ensure the DSC functions of the radio are operating correctly.

9.11.1 Transmitting a DSC Test Call

DSC Test Call from Individual / Position Call Directory

1. Press the **MENU** key to display the menu.
2. Press the **▲ / ▼** keys to select “DSC”, then press the **SELECT** soft key.
3. Press the **▲ / ▼** keys to select “TEST CALL”, and then press the **SELECT** soft key. (To cancel, press the **BACK** soft key.)

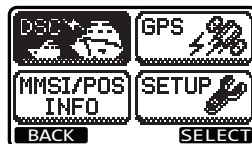

4. Press the **▲ / ▼** keys to select “MEMORY”, then press the **SELECT** soft key.

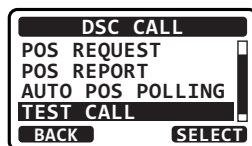

5. Press the **▲ / ▼** keys to select an individual you want to contact, then press the **SELECT** soft key.

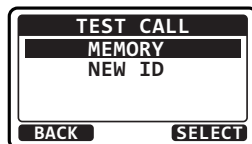

6. Press the **YES** soft key to transmit the test signal.

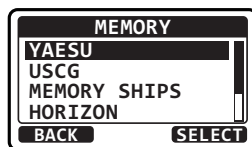

7. After the DSC test call is transmitted, the **GX1300** waits for a reply from the radio which was called, and the display will show “WAITING FOR ACK”.

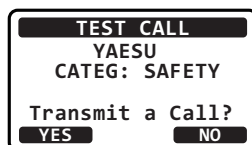

To transmit again, press the **RESEND** soft key.

8. When an acknowledgement signal is received, the **GX1300** will show “RX TEST CALL” screen, which confirms the radio you called has received the test call.
9. Press the **QUIT** soft key to return to the radio operation.

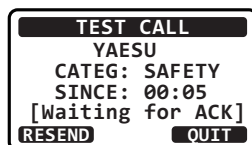

DSC Test Call - Manual MMSI Entry

1. Press the **MENU** key to display the menu.
2. Press the **▲ / ▼** keys to select “DSC”, then press the **SELECT** soft key.
3. Press the **▲ / ▼** keys to select “TEST CALL”, and then press the **SELECT** soft key. (To cancel, press the **BACK** soft key.)



4. Press the **▲ / ▼** keys to select “NEW ID”, then press the **SELECT** soft key.

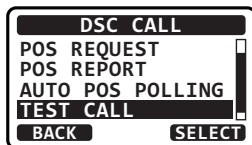

5. Press the **▲ / ▼** keys to scroll through numbers, 0 to 9.
6. Press the **SELECT** soft key to store the number and step to the next digit to the right.

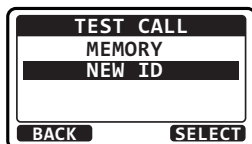

7. Repeat steps 5 and 6 until the MMSI is complete.
If a mistake was made entering in the MMSI number, press the **◀ / ▶** keys repeatedly until the wrong number is highlighted, then press the **▲ / ▼** keys to correct the entry.
8. After the ninth number has been entered, press the **FINISH** soft key.
9. Press the **YES** soft key to transmit the test signal.

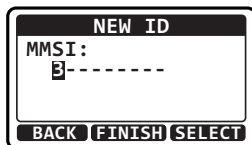

10. After the DSC test call is transmitted, the **GX1300** waits for a reply from the radio which was called, and the display will show “WAITING FOR ACK”.

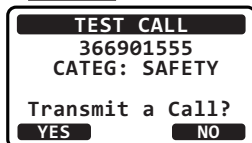

To transmit again, press the **RESEND** soft key.

11. When an acknowledgement signal is received, the display will show “Received ACK”.

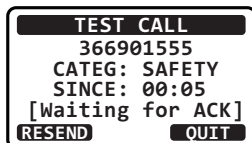

12. Press the **QUIT** soft key to return to the radio operation.

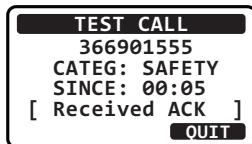

9.11.2 Receiving a DSC Test Call

When another vessel transmits a DSC test call to the **GX1300**, the radio automatically reply an acknowledgement. The display shows the MMSI or the name of the vessel transmitting the DSC test call.

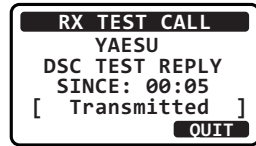

Press the **QUIT** soft key to return to radio operation.

9.12 POLLING CALL

The GX1300 has the capability to track another vessel.

9.12.1 Transmitting a Polling Call

Position Polling from Individual / Position Call Directory

1. Press the **MENU** key to display the menu.
2. Press the **▲ / ▼** keys to select “DSC”, then press the **SELECT** soft key.
3. Press the **▲ / ▼** keys to select “POLLING CALL”, and then press the **SELECT** soft key. (To cancel, press the **BACK** soft key.)



4. Press the **▲ / ▼** keys to select “HISTORY” or “MEMORY”, then press the **SELECT** soft key.

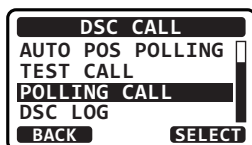

5. Press the **▲ / ▼** keys to select an individual you want to contact, then press the **SELECT** soft key.

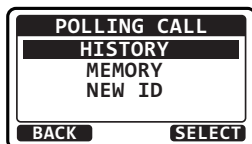

6. Press the **YES** soft key to transmit the polling signal.

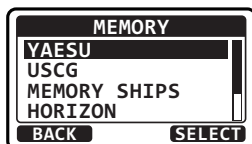

7. After the polling call is transmitted, the **GX1300** waits for a reply from the radio which was called, and the display will show “WAITING FOR ACK”.

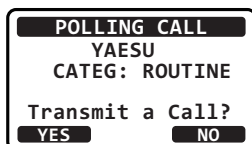

To transmit again, press the **RESEND** soft key.

8. When an acknowledgement signal is received, the display will show “Received ACK”.

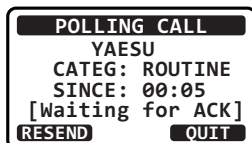

9. Press the **QUIT** soft key to return to the radio operation.

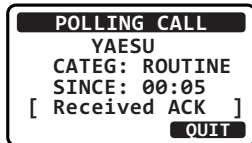

Position Polling - Manual MMSI Entry

1. Press the **MENU** key to display the menu.
2. Press the **▲ / ▼** keys to select “DSC”, then press the **SELECT** soft key.
3. Press the **▲ / ▼** keys to select “POLLING CALL”, and then press the **SELECT** soft key. (To cancel, press the **BACK** soft key.)

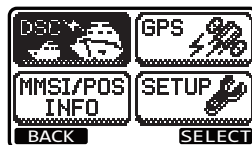

4. Press the **▲ / ▼** keys to select “NEW ID”, then press the **SELECT** soft key.

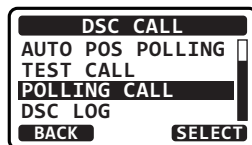

5. Press the **▲ / ▼** keys to scroll through numbers, 0 to 9.
6. Press the **SELECT** soft key to store the number and step to the next digit to the right.

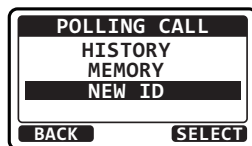

7. Repeat steps 5 and 6 until the MMSI is complete.

If a mistake was made entering in the MMSI number, press the **◀ / ▶** keys repeatedly until the wrong number is highlighted, then press the **▲ / ▼** keys to correct the entry.

8. After the ninth number has been entered, press the **FINISH** soft key.
9. Press the **YES** soft key to transmit the polling signal.



10. After the polling call is transmitted, the **GX1300** waits for a reply from the radio which was called, and the display will show “WAITING FOR ACK”.

To transmit again, press the **RESEND** soft key.

11. When an acknowledgement signal is received, the display will show “Received ACK”.

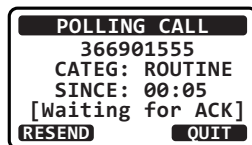
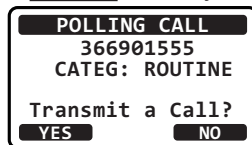

12. Press the **QUIT** soft key to return to the radio operation.

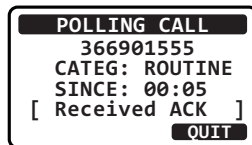

9.12.2 Receiving a Polling Call

When another vessel transmits a polling call to the **GX1300**, the radio automatically reply an acknowledgement. The display shows the MMSI or the name of the vessel transmitting the polling call.

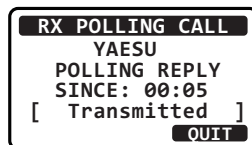

Press the **QUIT** soft key to return to radio operation.

9.13 DSC LOG OPERATION

The **GX1300** logs transmitted DSC calls, received distress calls, and other calls (individual, group, all ships, etc.). The DSC log feature is similar to an answer machine where calls are recorded for review and a “✉” icon will appear on the radio's display. The **GX1300** can store up to the latest 30 transmitted calls, up to the latest 30 distress calls, and up to the latest 50 other calls.

NOTE

When the “DSC LOG” menu is selected, the **GX1300** will display the highest priority logged calls automatically.

9.13.1 Reviewing a Logged Transmitted Call

1. Press the **MENU** key to display the menu.
2. Press the **▲ / ▼** keys to select “DSC”, then press the **SELECT** soft key.
3. Press the **▲ / ▼** keys to select “DSC LOG”, and then press the **SELECT** soft key. (To cancel, press the **BACK** soft key.)
4. Press the **▲ / ▼** key to select “TRANSMITTED LOG”, then press the **SELECT** soft key.
5. Press the **▲ / ▼** key to select the station (name or MMSI number) you want to review the call, then press the **SELECT** soft key.

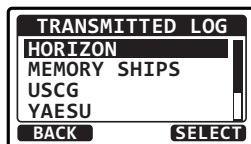
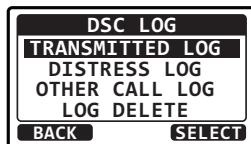
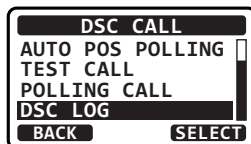
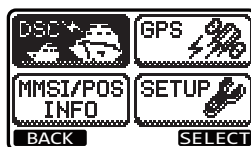

- Press the ▲ / ▼ key to scroll the display.

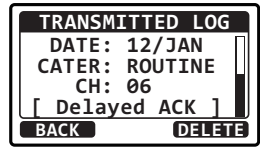
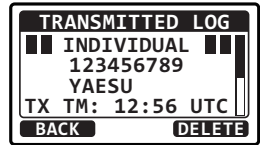

- Press the **BACK** soft key to go back to the DSC transmitted call list.

9.13.2 Reviewing a Logged DSC Distress Call

- Press the **MENU** key to display the menu.
- Press the ▲ / ▼ keys to select “DSC”, then press the **SELECT** soft key.
- Press the ▲ / ▼ keys to select “DSC LOG”, and then press the **SELECT** soft key. (To cancel, press the **BACK** soft key.)

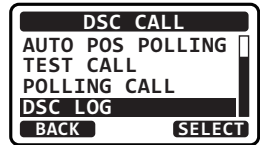

- Press the ▲ / ▼ key to select “DISTRESS LOG”, then press the **SELECT** soft key.

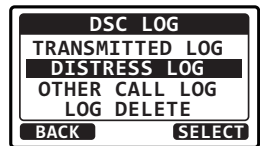

- Press the ▲ / ▼ key to select the station (name or MMSI number) you want to review.

Note: When there is an unread received call, “” icon will appear at the head of the station name (or MMSI number).

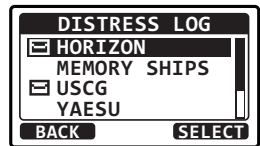

Press the **SELECT** soft key to review details for the selected station.

6. Press the ▲ / ▼ key to scroll the display.

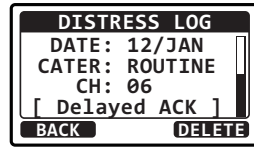
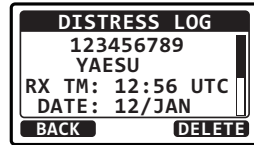

7. Press the **BACK** soft key to go back to the DSC distress call list.

9.13.3 Reviewing a Logged Other Calls

The **GX1300** allows received calls (individual, group, all ships, etc.) to be reviewed.

1. Press the **MENU** key to display the menu.
2. Press the ▲ / ▼ keys to select “DSC”, then press the **SELECT** soft key.
3. Press the ▲ / ▼ keys to select “DSC LOG”, and then press the **SELECT** soft key. (To cancel, press the **BACK** soft key.)

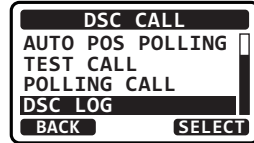

4. Press the ▲ / ▼ key to select “OTHER CALL LOG”, then press the **SELECT** soft key.



5. Press the ▲ / ▼ key to select the station (name or MMSI number) you want to review.

Note: When there is an unread received call, “” icon will appear at the head of the station name (or MMSI number).

Press the **SELECT** soft key, to review details for the selected station.

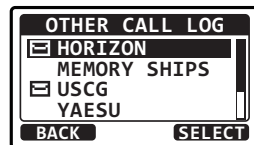

- Press the ▲ / ▼ key to scroll the display.

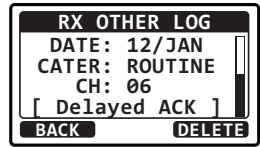
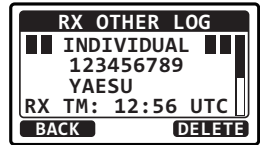

- Press the **BACK** soft key to go back to the DSC other call list.

9.13.4 Deleting Calls from the “DSC LOG” Directory

- Press the **MENU** key to display the menu.
- Press the ▲ / ▼ keys to select “DSC”, then press the **SELECT** soft key.
- Press the ▲ / ▼ keys to select “DSC LOG”, and then press the **SELECT** soft key. (To cancel, press the **BACK** soft key.)

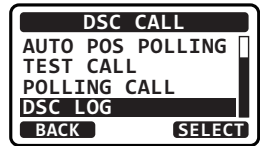
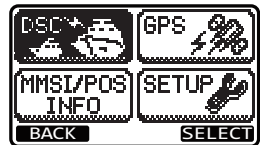

- Press the ▲ / ▼ key to select “LOG DELETE”, then press the **SELECT** soft key.



- Press the ▲ / ▼ key to select the category (“TRANSMITTED LOG”, “DISTRESS LOG”, “OTHER CALL LOG”, or “ALL LOG”) to be deleted, then press the **SELECT** soft key.



- Press the **YES** soft key to delete logs of the selected category. (To cancel, press the **NO** soft key.)



7. Press the **OK** soft key to go back to the category list.

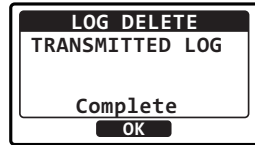

NOTE

The procedure above will delete logged calls of the selected category all at once.

To delete logged calls one by one, review details of a call you want to delete, then press the **DELETE** soft key.

10 SETUP MENU

10.1 CONFIGURATION SETUP

10.1.1 Lamp Adjustment

Allows adjustment of the backlight intensity or to turn it off.

1. Press the **MENU** key to display the menu.
2. Press the **▲ / ▼** keys to select “SETUP”, then press the **SELECT** soft key.
3. Press the **▲ / ▼** keys to select “CONFIGURATION”, then press the **SELECT** soft key.

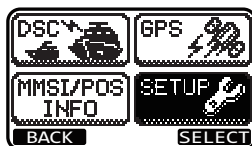

4. Select “DIMMER” with the **▲ / ▼** keys, then press the **SELECT** soft key.

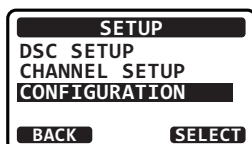

5. Press the **▲ / ▼** keys to select the desired level. When “OFF” is selected, the lamp is extinguished.
6. Press the **ENTER** soft key to store the selected level.

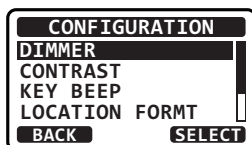

7. To exit this menu and return to radio operation press the **BACK** soft key.

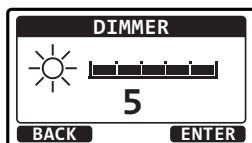

10.1.2 LCD Contrast

This selection sets up the display contract to optimize the viewing angle for the varying mounting locations (overhead or below).

1. Press the **MENU** key to display the menu.
2. Press the **▲ / ▼** keys to select “SETUP”, then press the **SELECT** soft key.
3. Press the **▲ / ▼** keys to select “CONFIGURATION”, then press the **SELECT** soft key.

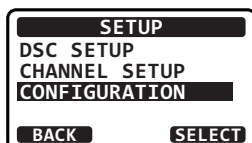
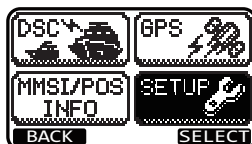

- Select "CONTRAST" with the ▲ / ▼ keys, then press the **SELECT** soft key.

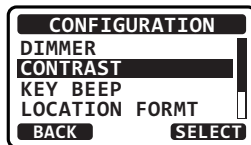

- Press the ▲ / ▼ keys to select the desired level. The contrast level can be set from "00" to "25".

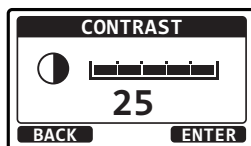

- Press the **ENTER** soft key to store the selected level.
- To exit this menu and return to radio operation press the **BACK** soft key.

10.1.3 Key Beep

This section allows the level of the key beep to be adjusted or turned off.

- Press the **MENU** key to display the menu.
- Press the ▲ / ▼ keys to select "SETUP", then press the **SELECT** soft key.
- Press the ▲ / ▼ keys to select "CONFIGURATION", then press the **SELECT** soft key.

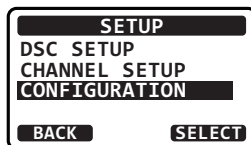
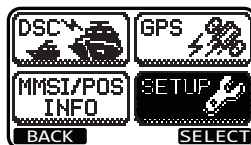

- Select "KEY BEEP" with the ▲ / ▼ keys, then press the **SELECT** soft key.

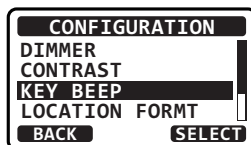

- Press the ▲ / ▼ keys to select the desired beep level. The key beep level can be set from "0" (OFF) to "5".

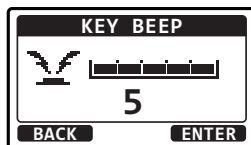

- Press the **ENTER** soft key to store the selected level.
- To exit this menu and return to radio operation press the **BACK** soft key.

NOTE

Emergency alarm and beeps for DSC operation cannot be turned OFF.

10.1.4 Location Format

This selection sets the coordinate system to be shown on the LCD.

1. Press the **MENU** key to display the menu.
2. Press the **▲ / ▼** keys to select “SETUP”, then press the **SELECT** soft key.
3. Press the **▲ / ▼** keys to select “CONFIGURATION”, then press the **SELECT** soft key.

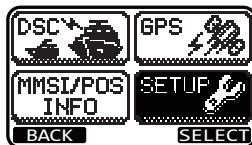

4. Select “LOCATION FORMAT” with the **▲ / ▼** keys, then press the **SELECT** soft key.

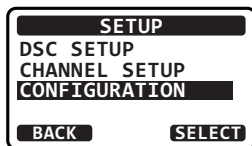

5. Press the **▲ / ▼** keys to select the desired coordinate system.
6. Press the **ENTER** soft key to store the selected level.

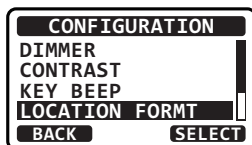

7. To exit this menu and return to radio operation press the **BACK** soft key.

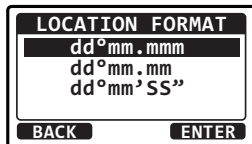

10.1.5 Time Offset

This selection sets the time offset from UTC (time GPS sends to radio).

Refer to section “6.6 CHANGING THE GPS TIME” for details.

10.1.6 Time Display

This selection selects the time area between the local time and the UTC time.

Refer to section “6.7 CHANGING THE TIME LOCATION” for details.

10.1.7 Time Format

This selection selects the time format between the 12-hour system and the 24-hour system.

Refer to section “6.8 CHANGING THE TIME FORMAT” for details.

10.1.8 Unit Of Measure

This selection sets the distance units.

1. Press the **MENU** key to display the menu.
2. Press the **▲ / ▼** keys to select “SETUP”, then press the **SELECT** soft key.
3. Press the **▲ / ▼** keys to select “CONFIGURATION”, then press the **SELECT** soft key.



4. Select “UNIT OF MEASURE” with the **▲ / ▼** keys, then press the **SELECT** soft key.

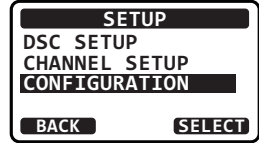

5. Press the **▲ / ▼** keys to select “DISTANCE”, then press the **SELECT** soft key.

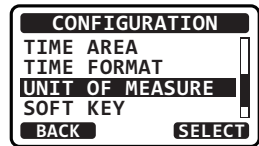

6. Press the **▲ / ▼** keys to select the unit.
7. Press the **ENTER** soft key to store the new setting.

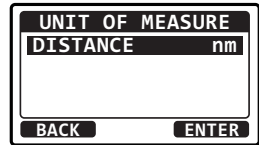

8. To exit this menu and return to radio operation press the **BACK** soft key.

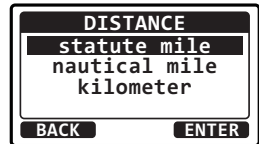

10.1.9 Soft Keys

This menu item assigns the number of soft keys, soft key selection and how long the display will show the soft key icon after a soft key is pressed.

Assigning Soft Keys

1. Press the **MENU** key to display the menu.
2. Press the **▲ / ▼** keys to select “SETUP”, then press the **SELECT** soft key.
3. Press the **▲ / ▼** keys to select “CONFIGURATION”, then press the **SELECT** soft key.



4. Select “SOFT KEY” with the **▲ / ▼** keys, then press the **SELECT** soft key.

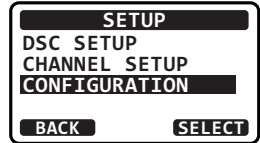

5. Press the **▲ / ▼** keys to select “KEY ASSIGNMENT”, then press the **SELECT** soft key.

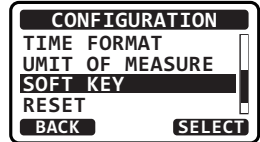

6. Press the **▲ / ▼** keys to select the desired soft key number, then press the **SELECT** soft key.

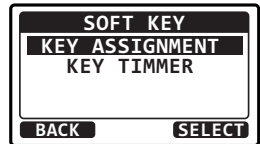

7. Press the **▲ / ▼** keys to select the desired key function, then press the **ENTER** soft key. Refer to the next page for available functions.

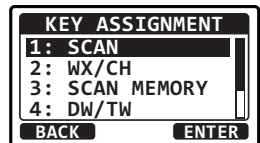

8. Repeat steps 6 and 7 to assign up to 6 functions.
9. To exit this menu and return to radio operation press the **BACK** soft key.

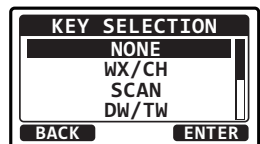

Available functions are:

DISPLAY	FUNCTION
WX/CH	Switches channels between weather and marine.
SCAN	Starts and stops scanning.
DW/TW	Starts and stops the dual or triple watch scan.
SCAN MEMORY	Switches on and off of the memory channel scan.
PRESET	Saves or deletes the preset memory channel.
GPS STATUS	GPS status display

Selecting How Long the Soft Keys are Shown

1. Press the **MENU** key to display the menu.
2. Press the **▲ / ▼** keys to select “SETUP”, then press the **SELECT** soft key.
3. Press the **▲ / ▼** keys to select “CONFIGURATION”, then press the **SELECT** soft key.

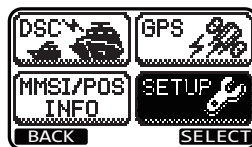

4. Select “SOFT KEY” with the **▲ / ▼** keys, then press the **SELECT** soft key.

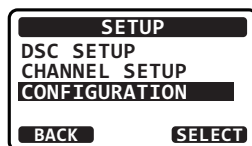

5. Press the **▲ / ▼** keys to select “KEY TIMER”, then press the **SELECT** soft key.

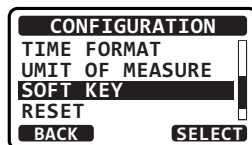

6. Press the **▲ / ▼** keys to select how long the soft key icon will be shown on the display after a soft key is pressed, then press the **ENTER** soft key.

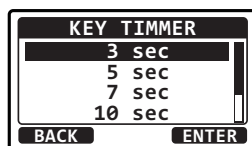
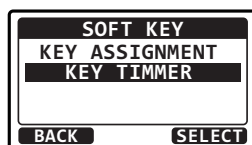

The showing time can be set to “3 sec”, “5 sec”, “7 sec”, “10 sec”, or “15 sec”.

7. To exit this menu and return to radio operation press the **BACK** soft key.

10.2 CHANNEL SETUP

10.2.1 Channel Group (Band Selection)

This selection allows you to change the channel group from International to USA or Canada.

Refer to section “8.5 INTERNATIONAL, USA, AND CANADA MODE” for details.

10.2.2 Weather Alert

This selection is used to enable or disable the NOAA Weather Alert function.

1. Press the **MENU** key to display the menu.
2. Select “SETUP” with the ▲ / ▼ / ◀ / ▶ keys, then press the **SELECT** soft key.
3. Press the ▲ / ▼ key to select “CHANNEL SETUP”, then press the **SELECT** soft key.

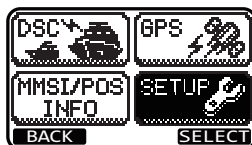

4. Press the ▲ / ▼ key to select “WEATHER ALERT”, then press the **SELECT** soft key.

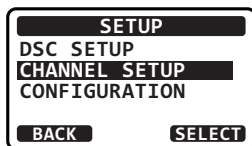

5. Press the ▲ / ▼ keys to select “ON” or “OFF”.
6. Press the **ENTER** soft key to store the selected setting.



7. Press the **BACK** soft key to exit the menu and return to radio operation.

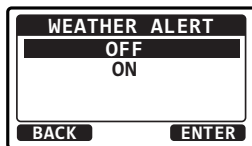

10.2.3 Multi Watch

Allows selection of the dual and triple watch functions.

Refer to section “8.8 MULTI WATCH (TO PRIORITY CHANNEL)” for details.

10.2.4 Scan Memory

To be able to scan channels the radio must be programmed. This section allows channels to be stored in scan memory.

Refer to section “8.7.2 Scan Memory Programming” for details.

10.2.5 Scan Type

This selection is used to select the scan mode between “Memory Scan” and “Priority Scan”.

Refer to section “8.7.1 Selecting the Scan Type” for details.

10.2.6 Scan Resume

This selection is used to select the time the **GX1300** waits after a transmission ends before the radio start to scan channels again.

1. Press the **MENU** key to display the menu.
2. Select “SETUP” with the **▲ / ▼ / ◀ / ▶** keys, then press the **SELECT** soft key.
3. Press the **▲ / ▼** key to select “CHANNEL SETUP”, then press the **SELECT** soft key.



4. Press the **▲ / ▼** key to select “SCAN RESUME”, then press the **SELECT** soft key.

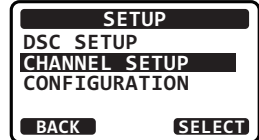

5. Press the **▲ / ▼** keys to select the desired resume time.
6. Press the **ENTER** soft key to store the selected setting.

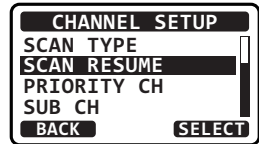

7. Press the **BACK** soft key to exit the menu and return to radio operation.

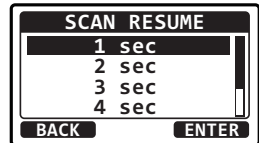

10.2.7 Priority Channel

Allows selection of the priority channel.

Refer to section “8.7.4 Priority Channel Setting” for details.

10.2.8 Sub Channel

Allows selection of the sub channel. The default setting is Channel 9.

1. Press the **MENU** key to display the menu.
2. Select "SETUP" with the **▲ / ▼ / ◀ / ▶** keys, then press the **SELECT** soft key.
3. Press the **▲ / ▼** key to select "CHANNEL SETUP", then press the **SELECT** soft key.



4. Press the **▲ / ▼** key to select "SUB CH", then press the **SELECT** soft key.

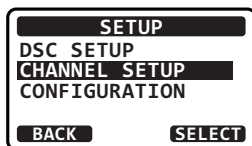

5. Press the **▲ / ▼** keys to select the sub channel.
6. Press the **ENTER** soft key to store the selected setting.

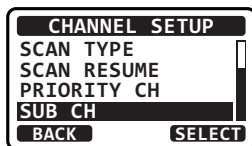

7. Press the **BACK** soft key to exit the menu and return to radio operation.

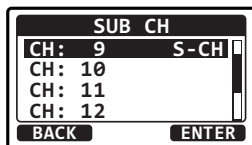

10.3 DSC SETUP

10.3.1 Individual Directory

The **GX1300** has a DSC directory that allows you to store a vessel or person's name and the MMSI number associated with vessels you wish to transmit individual calls, position requests and position report transmissions.

To transmit an individual call you must program this directory with information of the persons you wish to call, similar to a cellular phones telephone directory.

Refer to section "**9.5.1 Setting up the Individual / Position Call Directory**" for programming.

10.3.2 Individual Reply

This menu item sets up the radio to automatically (default setting) or manually respond to a DSC individual call requesting you to switch to a working channel for voice communications. When the manual response is selected the MMSI of the calling vessel is shown allowing you to see who is calling. This function is similar to caller id on a cellular phone.

Refer to section "**9.5.2 Setting up Individual Call Reply**" for setting.

10.3.3 Individual Acknowledgement

The radio can be setup to transmit a reply automatically (default) or set so the radio will not reply to an individual call.

Refer to section "**9.5.3 Setting up the Individual Acknowledge Message**" for setting.

10.3.4 Individual Ringer

The radio can be setup to ring like a telephone to alert you the radio received a DSC individual call. The default setting is 2 minutes, however this can be changed to 15, 10 or 5 seconds.

Refer to section "**9.5.6 Setting up Individual Call Ringer**" for setting.

10.3.5 Group Directory

For this function to operate, the same group MMSI must be programmed into all the DSC VHF radios within the group of vessels that will be using this feature. To understand group MMSI programming, first a ship MMSI has to be understood.

Refer to section “**9.6.1 Setting up a Group Call**” for programming.

10.3.6 Auto Position Polling Call Type

The **GX1300** has the capability to automatically track four vessels programmed into the individual directory. This selection allows you to select the call type used in the auto position polling.

Refer to section “**9.10.1 Setting up the Polling Call Type**” for setting.

10.3.7 Auto Position Polling Interval Time

The **GX1300** has the capability to automatically track four vessels programmed into the individual directory. This selection allows you to select time interval between polling call transmissions.

Refer to section “**9.10.2 Setting up the Polling Time Interval**” for setting.

10.3.8 Auto Channel Switching Time

When a DSC distress call or an all ships call (urgency or safety) is received, the **GX1300** will automatically switch to the channel 16.

This menu selection allows the automatic switching time to be changed.

1. Press the **MENU** key to display the menu.
2. Press the **▲ / ▼** keys to select “SETUP”, then press the **SELECT** soft key.
3. Press the **▲ / ▼** keys to select “DSC SETUP”, then press the **SELECT** soft key. (To cancel, press the **BACK** soft key.)

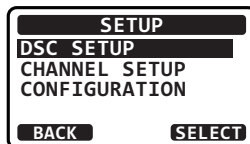
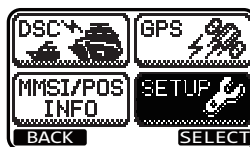

4. Select “CH SWITCH TIMER” with the **▲ / ▼** keys, then press the **SELECT** soft key.

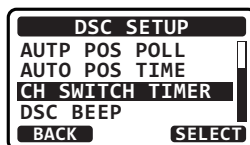

5. Press the **▲ / ▼** keys to select the desired time, then press the **ENTER** soft key. The switching time can be set to “OFF”, “10 sec”, “30 sec”, “1 min”, or “2 min”.

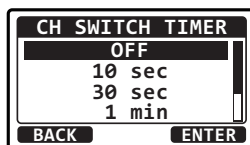

6. Press the **BACK** soft key to exit the menu and return to radio operation.

10.3.9 DSC Beep

This feature allows the alarm beeps to be turned on (default setting) or off when a DSC call is received. The DSC calls that can be customized are: individual, group, all ships, position request, position report call.

Refer to section “**9.6.4 Setting up the Group Call Ringer**” for setting.

11 MAINTENANCE

The inherent quality of the solid-state components used in this transceiver will provide many years of continuous use. Taking the following precautions however, will prevent damage to the transceiver.

- Never key the microphone unless an antenna or suitable dummy load is connected to the transceiver.
- Ensure that the supply voltage to the transceiver does not exceed 16 VDC or fall below 11 VDC.
- Use only STANDARD HORIZON-approved accessories and replacement parts.

In the unlikely event of serious problems, please contact your Dealer or our repair facility.

11.1 REPLACEMENT PARTS

Commonly requested parts, and their part numbers are listed below.

- **Power Cord:** T9025406
- **VOL/SQL Knob (Black):** RA6018100
- **VOL/SQL Knob (White):** RA6018000
- **Mounting Bracket (Black):** RA097840A
- **Mounting Bracket (White):** RA097830A
- **Mounting Bracket Knob (Black):** RA0978600
- **Mounting Bracket Knob (White):** RA0978500
- **Microphone Hanger (Black):** RA0458800
- **Microphone Hanger (White):** RA0436000

11.2 FACTORY SERVICE

In the unlikely event that the radio fails to perform or needs servicing, please contact your dealer.

An "RA" (Return Authorization) number is not necessary to send a product in for service. Include a brief note describing the problem along with your name, return address, phone number, and proof of purchase.

11.3 TROUBLESHOOTING CHART

SYMPTOM	PROBABLE CAUSE	REMEDY
Transceiver fails to power up.	No DC voltage to the transceiver, or blown fuse.	a. Check the 12 VDC battery connections and the fuse. b. The VOL knob needs to be rotated clockwise to turn the radio on.
Transceiver blows fuse when connected to power supply.	Reversed power wires.	Check the power cable for DC voltage, or replace the fuse (6 A 250 V). Make sure the red wire is connected to the positive (+) battery post, and the black wire is connected to the negative (-) battery post. If the fuse still blows, contact your Dealer.
Popping or whining noise from the speaker while engine runs.	Engine noise.	Reroute the DC power cables away from the engine. Add noise suppressor on power cable. Change to resistive spark plug wires and/or add an alternator whine filter.
Sound is not emitted from the internal or external speaker.	Accessory cable.	Check the connections of the accessory cable (Possible short circuit on the External speaker cable WHITE/SHIELD).
Receiving station report low transmit power, even with transceiver set to HI power.	Antenna.	Have the antenna checked or test the transceiver with another antenna. If the problem persists, contact your Dealer for servicing.
"HI BATTERY" or "LO BATTERY" message is appeared when the power is turned on.	The power supply voltage is too high or too low.	Confirm that the connected power supply voltage is between 11 volts and 16.6 volts DC. Confirm that the generator has not malfunctioned.
Your position is not displayed.	Accessory cable.	Check the accessory cable connection. Some GPS use the battery ground line for NMEA connection.
	Setting of the GPS navigation receiver.	Check the output signal format of the GPS navigation receiver. This radio requires NMEA0183 format with GLL, RMC, GGA, or GNS sentence as an output signal. If the GPS has a baud rate setting make sure to select 4800 and parity to NONE.

12 CHANNEL ASSIGNMENTS

Tables on the following columns list the VHF Marine Channel assignments for U.S.A. and International use. Below are listed some data about the charts.

1. VTS. Where indicated, these channels are part of the U.S. Coast Guard's Vessel Traffic System.
2. Alpha channel numbers, that is, channel numbers followed by the letter A (such as Channel 07**A**) are **simplex** channels on the U.S.A. or Canadian channel assignments whose counterparts in the International assignments are **duplex** channels. International channels do not use "alpha" numbers. If you call the Coast Guard on Channel 16, they will sometimes ask you to "**go to channel 22 Alpha.**" This is a channel assigned to U.S.A. and Canadian Coast Guards for handling distress and other calls. If your radio is set for **International** operation you will go to Channel 22 instead of 22**A**, and will not be able to communicate with the Coast Guard. To use Channel 22**A**, your radio must be set for **USA** or **Canada** operation, usually by a U/I/C (USA/International/Canada) control or combination of controls. Channel 22 (without an "A") is an **International** duplex channel for port operations. Some radios indicate an "A" adjacent to the alpha channels on the display; on others "alpha" is not indicated but the proper channel is selected based on the U/I/C setting.
3. Bridge-to-Bridge channels (for example, Channel 13) are for use by bridge operators on inter-coastal waterways and rivers. It is also used by marine vessels in the vicinity of these bridges for navigation and for communicating with the bridge operators. Note that a limit of 1 Watt is specified for these channels.
4. The **S/D** column on the chart indicates either S (simplex) or D (duplex). **Simplex** means transmitting and receiving on the same frequency. Only one party at a time can talk, unlike a telephone. Be sure to say "**over**" and release your microphone push-to-talk switch at the end of each transmission. **Duplex** operation involves the use of one frequency for transmitting and a separate frequency for receiving. On channels specified as duplex on the charts, correct mode of operation is established automatically by your radio when you select a channel; you cannot change the mode. And you still must release the push-to-talk switch after each transmission in order to listen to the radio.
5. Channels normally used by recreational boaters are those that include the term "non-commercial" in the **Channel Use** column of the chart. Some of these are shared with other users and some are used only in certain geographic regions.

6. Marine vessels equipped with VHF radios are required to monitor Channel 16.
7. 156.050 MHz and 156.175 MHz are available for port operations and commercial communications purposes when used only within the U.S. Coast Guard designated Vessel Traffic Services (VTS) area of New Orleans, on the lower Mississippi River from the various pass entrances in the Gulf of Mexico to Devil's Swamp Light at River Mile 242.4 above head of passes near Baton Rouge.
8. 156.250 MHz is available for port operations communications use only within the U.S. Coast Guard designated VTS radio protection areas of New Orleans and Houston described in Sec. 80.383. 156.250 MHz is available for intership port operations communications used only within the area of Los Angeles and Long Beach harbors, within a 25- nautical mile radius of Point Fermin, California.
9. 156.550 MHz, 156.600 MHz and 156.700 MHz are available in the U.S. Coast Guard designated port areas only for VTS communications and in the Great Lakes available primarily for communications relating to the movement of ships in sectors designated by the St. Lawrence Seaway Development Corporation or the U.S. Coast Guard. The use of these frequencies outside VTS and ship movement sector protected areas is permitted provided they cause no interference to VTS and ship movement communications in their respective designated sectors.
10. Use of 156.875 MHz is limited to communications with pilots regarding the movement and docking of ships. Normal output power must not exceed 1 watt. 5: 156.375 MHz and 156.650 MHz are available primarily for intership navigational communications. These frequencies are available between coast and ship on a secondary basis when used on or in the vicinity of locks or drawbridges. Normal output power must not exceed 1 watt. Maximum output power must not exceed 10 watts for coast stations or 25 watts for ship stations.
11. On the Great Lakes, in addition to bridge-to-bridge communications, 156.650 MHz is available for vessel control purposes in established vessel traffic systems. 156.650 MHz is not available for use in the Mississippi River from South Pass Lighted Whistle Buoy "2" and Southwest Pass entrance Mid-channel Lighted Whistle Buoy to mile 242.4 above Head of Passes near Baton Rouge. Additionally it is not available for use in the Mississippi River-Gulf Outlet, the Mississippi River-Gulf Outlet Canal, and the Inner Harbor Navigational Canal, except to aid the transition from these areas.

12. Use of 156.375 MHz is available for navigational communications only in the Mississippi River from South Pass Lighted Whistle Buoy "2" and Southwest Pass entrance Mid channel Lighted Whistle Buoy to mile 242.4 above head of Passes near Baton Rouge, and in addition over the full length of the Mississippi River-Gulf Outlet Canal from entrance to its junction with the Inner Harbor Navigation Canal, and over the full length of the Inner Harbor Navigation Canal from its junction with the Mississippi River to its entry to Lake Pontchartrain at the New Seabrook vehicular bridge.
13. Within 120 km (75 miles) of the United States/Canada border, in the area of the Puget Sound and the Strait of Juan de Fuca and its approaches, 157.425 MHz is half of the duplex pair designated as Channel 88. In this area, Channel 88 is available to ship stations for communications with public coast stations only. More than 120 km (75 miles) from the United States/Canada border in the area of the Puget Sound and the Strait of Juan de Fuca, its approaches, the Great Lakes, and the St. Lawrence Seaway, 157.425 MHz is available for intership and commercial communications. Outside Puget Sound area and its approaches and the Great Lakes, 157.425 MHz is also available for communications between commercial fishing vessels and associated aircraft while engaged in commercial fishing activities.
14. When the frequency 156.850 MHz is authorized, it may be used additionally for search and rescue training exercises conducted by state or local governments.
15. The frequency 156.850 MHz is additionally available to coast stations on the Great Lakes for transmission of scheduled Coded Marine Weather Forecasts (MAFOR), Great Lakes Weather Broadcast (LAWEB) and scheduled Notices to Mariners or Bulletins. F3C and J3C emissions are permitted. Coast Stations on the Great Lakes must cease weather broadcasts which cause interference to stations operating on 156.800 MHz until the interference problem is resolved.
16. The frequency 157.100 MHz is authorized for search and rescue training exercises by state or local government in conjunction with U.S. Coast Guard stations. Prior U.S. Coast Guard approval is required. Use must cease immediately on U.S. Coast Guard request.
17. The duplex pair for channel 20 (157.000/161.600 MHz) may be used for ship to coast station communications.
18. Available for assignment to coast stations, the use of which is in accord with an agreed program, for the broadcast of information to ship stations concerning the environment.

VHF MARINE CHANNEL CHART

CH	U	C	I	S/D	TX	RX	CHANNEL USE
01		X	X	D	156.050	160.650	Public Correspondence (Marine Operator)
01A	X			S	156.050		Port Operation and Commercial. VTS in selected areas
02		X	X	D	156.100	160.700	Public Correspondence (Marine Operator)
03		X	X	D	156.150	160.750	Public Correspondence (Marine Operator)
03A	X			S	156.150		U.S. Government Only, Coast Guard
04			X	D	156.200	160.800	Public Correspondence (Marine Operator), Port operation, ship movement
04A		X		S	156.200		Pacific coast: Coast Guard, East Coast: Commercial fishing
05			X	D	156.250	160.850	Public Correspondence (Marine Operator), Port operation, ship movement
05A	X	X		S	156.250		Port operation. VTS in Seattle
06	X	X	X	S	156.300		Inter-ship Safety
07			X	D	156.350	160.950	Public Correspondence (Marine Operator), Port operation, ship movement
07A	X	X		S	156.350		Commercial
08	X	X	X	S	156.400		Commercial (Inter-ship only)
09	X	X	X	S	156.450		Boater Calling channel, Commercial & Non-commercial (Recreational)
10	X	X	X	S	156.500		Commercial
11	X	X	X	S	156.550		Commercial. VTS in selected areas
12	X	X	X	S	156.600		Port operation. VTS in selected areas
13	X	X	X	S	156.650		Inter-ship Navigation Safety (Bridge-to-bridge)
14	X	X	X	S	156.700		Port operation. VTS in selected areas
15	X			S	---	156.750	Environmental (Receive only)
15		X	X	S	156.750		Commercial, non-commercial, ship movement (1 W)
16	X	X	X	S	156.800		International Distress, Safety and Calling
17	X	X	X	S	156.850		State Controlled (1 W)
18			X	D	156.900	161.500	Port operation, ship movement
18A	X	X		S	156.900		Commercial
19			X	D	156.950	161.550	Port operation, ship movement
19A	X			S	156.950		US: Commercial
19A		X		S	156.950		Coast Guard
20	X	X	X	D	157.000	161.600	Canadian Coast Guard Only, International: port operations and shipment
20A	X			S	157.000		Port operation
21			X	D	157.050	161.650	Port operation, ship movement
21A	X	X		S	157.050		U.S. Government Only, Canadian Coast Guard
22			X	D	157.100	161.700	Port operation, ship movement
22A	X	X		S	157.100		US and Canadian Coast Guard Liaison and maritime Safety Information Broadcasts announced on channel 16
23		X	X	D	157.150	161.750	Public Correspondence (Marine Operator)
23A	X			S	157.150		U.S. Government Only
24	X	X	X	D	157.200	161.800	Public Correspondence (Marine Operator)
25	X	X	X	D	157.250	161.850	Public Correspondence (Marine Operator)
26	X	X	X	D	157.300	161.900	Public Correspondence (Marine Operator)
27	X	X	X	D	157.350	161.950	Public Correspondence (Marine Operator)
28	X	X	X	D	157.400	162.000	Public Correspondence (Marine Operator)

VHF MARINE CHANNEL CHART							
CH	U	C	I	S/D	TX	RX	CHANNEL USE
60		X	X	D	156.025	160.625	Public Correspondence (Marine Operator)
61			X	D	156.075	160.675	Public Correspondence (Marine Operator), Port operation, ship movement
61A	X	X		S	156.075		Public Coast: Coast Guard; East Coast: commercial fishing only
62			X	D	156.125	160.725	Public Correspondence (Marine Operator), Port operation, ship movement
62A		X		S	156.125		Public Coast: Coast Guard; East Coast: commercial fishing only
63			X	D	156.175	160.775	Public Correspondence (Marine Operator), Port operation, ship movement
63A	X	X		S	156.175		Port Operation and Commercial. VTS in selected areas
64		X	X	D	156.225	160.825	Public Correspondence (Marine Operator), Port operation, ship movement
64A	X	X		S	156.225		Public Correspondence (Marine Operator), Port operation, ship movement
65			X	D	156.275	160.875	Public Correspondence (Marine Operator), Port operation, ship movement
65A	X	X		S	156.275		Port Operations
66			X	D	156.325	160.925	Public Correspondence (Marine Operator), Port operation, ship movement
66A	X	X		S	156.325		Port Operations
67	X	X	X	S	156.375		US: Commercial. Used for Bridge-to-bridge communications in lower Mississippi River. Inter-ship only, Canada: Commercial fishing, S&R
68	X	X	X	S	156.425		Non-commercial (Recreational)
69	X	X	X	S	156.475		US: Non-commercial (Recreational), Canada: Commercial fishing only, International: Inter-ship, Port operations and Ship movement
70	X	X	X	S	156.525		Digital selective calling (voice communications not allowed)
71	X	X	X	S	156.575		US, Canada: Non-commercial (Recreational), International: Port operations and Ship movement
72	X	X	X	S	156.625		Non-commercial (Inter-ship only)
73	X	X	X	S	156.675		US: Port Operations, Canada: Commercial fishing only, International: Inter-ship, Port operations and Ship movement
74	X	X	X	S	156.725		US: Port Operations, Canada: Commercial fishing only, International: Inter-ship, Port operations and Ship movement
75	X	X	X	S	156.775		Port Operations (Inter-ship only) (1W)
76	X	X	X	S	156.825		Port Operations (Inter-ship only) (1W)
77	X	X		S	156.875		Port Operations (Inter-ship only) (1W)
77			X	S	156.875		Port Operations (Inter-ship only)
78			X	D	156.925	161.525	Public Correspondence (Marine Operator), Port operation, ship-movement
78A	X	X		S	156.925		Non-commercial (Recreational)
79			X	D	156.975	161.575	Port operation and Ship movement
79A	X	X		S	156.975		Commercial

VHF MARINE CHANNEL CHART							
CH	U	C	I	S/D	TX	RX	CHANNEL USE
80			X	D	157.025	161.625	Port operation, ship movement
80A	X	X		S	157.025		Commercial
81			X	D	157.075	161.675	Port operation, ship movement
81A	X			S	157.075		U.S. Government Only - Environmental protection operations
81A		X		S	157.075		Canadian Coast Guard Only
82			X	D	157.125	161.725	Public Correspondence (Marine Operator), Port operation, ship movement
82A	X	X		S	157.125		U.S. Government Only, Canadian Coast Guard Only
83		X		D	157.175	161.775	Canadian Coast Guard Only
83			X	D	157.175	161.775	Public Correspondence (Marine Operator)
83A	X	X		S	157.175		U.S. Government Only, Canadian Coast Guard Only
84	X	X	X	D	157.225	161.825	Public Correspondence (Marine Operator)
85	X	X	X	D	157.275	161.875	Public Correspondence (Marine Operator)
86	X	X	X	D	157.325	161.925	Public Correspondence (Marine Operator)
87		X	X	S	157.375		Port operation, ship movement
87A	X			S	157.375		Public Correspondence (Marine Operator)
88		X	X	S	157.425		Port operation, ship movement
88A	X			S	157.425		Commercial, Inter-ship Only
WX01	X	X	X	D	---	162.550	Weather (receive only)
WX02	X	X	X	D	---	162.400	Weather (receive only)
WX03	X	X	X	D	---	162.475	Weather (receive only)
WX04	X	X	X	D	---	162.425	Weather (receive only)
WX05	X	X	X	D	---	162.450	Weather (receive only)
WX06	X	X	X	D	---	162.500	Weather (receive only)
WX07	X	X	X	D	---	162.525	Weather (receive only)
WX08	X	X	X	D	---	161.650	Weather (receive only)
WX09	X	X	X	D	---	161.775	Weather (receive only)
WX10	X	X	X	D	---	163.275	Weather (receive only)

NOTE: Simplex channels, 03A, 21A, 23A, 61A, 64A, 81A, 82A and 83A CANNOT be lawfully used by the general public in U.S.A. waters.

13 WARRANTY

Marine Products Limited Warranty

PLEASE NOTE

The following “Limited Warranty” is for valid for products that have been purchased in the United States and Canada. For limited Warranty details outside the United States, contact the dealer in your country.

STANDARD HORIZON (a division of YAESU U.S.A.) warrants, to the original purchaser only, each new Marine Communications Product (“Product”) manufactured and/or supplied by STANDARD HORIZON against defects in materials and workmanship under normal use and service for a period of time from the date of purchase as follows:

Fixed Mount and Portable Transceivers

1 year - if purchased before 01/01/91

3 years - if purchased between 01/01/91 and 01/01/94

3 years Waterproof - if purchased after 01/01/94

Loud hailers

1 year - if purchased before 01/01/91

3 years - if purchased after 01/01/91

Associated Chargers

1 year - if purchased before 01/01/91

3 years - if purchased after 01/01/91

Associated Batteries - 1 year. Note: Batteries will be deemed defective only if storage capacity drops below 80% of rated capacity or if leakage develops.

Associated Accessories - 1 year. Includes: Microphones/Handsets, External Speakers, Antennas, Carrying Accessories, Power Supplies, and Signaling Boards.

To receive warranty service, the purchaser must deliver the Product, transportation and insurance prepaid, to STANDARD HORIZON, Attention Marine repairs 6125 Phyllis Drive, Cypress, California 90630, U.S.A. Include proof of purchase indicating model, serial number, and date of purchase. STANDARD HORIZON will return the Product to the purchaser freight prepaid. Products purchased prior to January 1, 1991 will bear the STANDARD HORIZON warranty terms in effect prior to that date.

In the event of a defect, malfunction or failure of the Product during the warranty period, STANDARD HORIZON’s liability for any breach of contract

or any breach of express or implied warranties in connection with the sale of Products shall be limited solely to repair or replacement, at its option, of the Product or part(s) therein which, upon examination by STANDARD HORIZON, appear to be defective or not up to factory specifications. STANDARD HORIZON may, at its option, repair or replace parts or subassemblies with new or reconditioned parts and subassemblies. Parts thus repaired or replaced are warranted for the balance of the original applicable warranty.

STANDARD HORIZON will not warrant installation, maintenance or service of the Products. In all instances, STANDARD HORIZON's liability for damages shall not exceed the purchase price of the defective Product.

This warranty only extends to Products sold within the 50 States of the United States of America and the District of Columbia.

STANDARD HORIZON will pay all labor to repair the product and replacement parts charges incurred in providing the warranty service except where purchaser abuse or other qualifying exceptions exist. The purchaser must pay any transportation expenses incurred in returning the Product to STANDARD HORIZON for service.

This limited warranty does not extend to any Product which has been subjected to misuse, neglect, accident, incorrect wiring by anyone other than STANDARD HORIZON, improper installation, or subjected to use in violation of instructions furnished by STANDARD HORIZON, nor does this warranty extend to Products on which the serial number has been removed, defaced, or changed. STANDARD HORIZON cannot be responsible in any way for ancillary equipment not furnished by STANDARD HORIZON which is attached to or used in connection with STANDARD HORIZON's Products, or for the operation of the Product with any ancillary equipment, and all such equipment is expressly excluded from this warranty. STANDARD HORIZON disclaims liability for range, coverage, or operation of the Product and ancillary equipment as a whole under this warranty. STANDARD HORIZON reserves the right to make changes or improvements in Products, during subsequent production, without incurring the obligation to install such changes or improvements on previously manufactured Products.

The implied warranties which the law imposes on the sale of this Product are expressly LIMITED, in duration, to the time period specified above. STANDARD HORIZON shall not be liable under any circumstances for consequential damages resulting from the use and operation of this Product, or from the breach of this LIMITED WARRANTY, any implied warranties,

or any contract with STANDARD HORIZON. IN CONNECTION WITH THE SALE OF ITS PRODUCTS, STANDARD HORIZON MAKES NO WARRANTIES, EXPRESS OR IMPLIED AS TO THE MERCHANTABILITY OR FITNESS FOR A PARTICULAR PURPOSE OR OTHERWISE, EXCEPT AS EXPRESSLY SET FORTH HEREIN.

Some states do not allow the exclusion or limitation of incidental or consequential damages, or limitation on how long an implied warranty lasts, so the above limitations or exclusions may not apply. This warranty gives specific legal rights, and there may be other rights which may vary from state to state.

ONLY PRODUCTS SOLD ON OR AFTER JANUARY 1, 1991 ARE COVERED UNDER THE TERMS OF THIS LIMITED WARRANTY.

ON-LINE WARRANTY REGISTRATION

THANK YOU for buying STANDARD HORIZON (a division of YAESU U.S.A.) products! We are confident your new radio will serve your needs for many years!

Please visit **www.standardhorizon.com** to register your Marine VHF. It should be noted that visiting the website from time to time may be beneficial to you, as new products are released they will appear on the STANDARD HORIZON website. Also a statement regarding product support should be added to the manual.

Product Support Inquiries

If you have any questions or comments regarding the use of the radio, you can visit the STANDARD HORIZON website to send an E-Mail or contact the Product Support team at (714) 827-7600 ext 6300 M-F 8:00-5:00 PST.

In addition to the warranty, STANDARD HORIZON includes a lifetime "flat rate" and "customer loyalty" programs to provide service after the warranty period has expired. If you wish to obtain the flat rate price for out-of-warranty repair, you must include the information on the Owner's Record with the unit when you return it to your Dealer or to STANDARD HORIZON.

Lifetime Flat Rate Service Program: For the original Owner only, for the lifetime of the unit, STANDARD HORIZON will repair the unit to original specifications.

Note: The flat rate amount is payable by the Owner only if STANDARD HORIZON or the STANDARD HORIZON Dealer determines that a repair is needed. After the repair, a 90-day warranty will be in effect from the date of return of the unit to the Owner.

This service program is not available for equipment which has failed as a result of neglect, accident, breakage, misuse, improper installation or modification, or water damage (depending on the product).

14 SPECIFICATIONS

Performance specifications are nominal, unless otherwise indicated, and are subject to change without notice.

14.1 GENERAL

Channels	All USA, International and Canadian
Input Voltage.....	13.8 VDC \pm 20%
Current Drain	
Standby	0.3 A
Receive	1.0 A
Transmit.....	5.5 A (Hi); 1.5 A (Lo)
Individual DSC Directory Memory	60
Group DSC Directory Memory.....	30
DSC Log Memory (Transmitted).....	30
DSC Log Memory (Distress).....	30
DSC Log Memory (Received).....	50
Dimensions (W x H x D)	6.10" x 2.36" x 5.91" (155 x 60 x 150 mm)
Flush-Mount Dimensions (W x H x D)	5.15" x 2.00" x 5.51" (131 x 51 x 140 mm)
Weight	1.91 lb (870 g)

14.2 TRANSMITTER

Frequency Range	156.025 to 157.425 MHz
RF Output	25 W (Hi); 1 W (Lo)
Conducted Spurious Emissions.....	80 dB (Hi); 66 dB (Lo)
Audio Response	within +1/-3 of a 6 dB/octave pre-emphasis characteristic at 300 to 3000 Hz
Audio Distortion	5 %
Modulation	16K0G3E, for DSC 16K0G2B
Frequency Stability (-4°F to +140°F (-20°C to +60°C)).....	\pm 0.0003 %
FM Hum and Noise.....	50 dB

14.3 RECEIVER

Frequency Range	156.050 to 162.000 MHz
Sensitivity	
20 dB SINAD	0.3 μ V
20 dB SINAD (70 CH Receiver)	0.3 μ V
Squelch Sensitivity (Threshold)	0.25 μ V
Modulation Acceptance Bandwidth	\pm 7.5 kHz
Selectivity	
Spurious and Image Rejection	-75 dB
Intermodulation and Rejection at 12 dB SINAD	-70 dB
Audio Output	4.5 W
Audio Response	within + 1/-3 of a 6 dB/octave de-emphasis characteristic at 300 to 3000 Hz
Frequency Stability (-4°F to +140°F (-20°C to +60°C))	\pm 0.0003 %
Channel Spacing	25 kHz
DSC Format	ITU-R M.493-13
NMEA Input/Output	Output - DSC, DSE Input - GLL, GGA, RMC, GNS, GSA, GSV

14.4 GX1300 DIMENSIONS

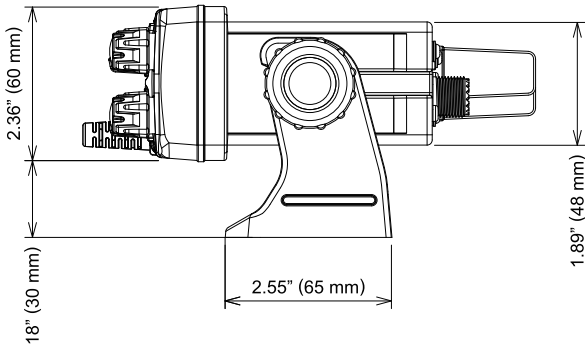
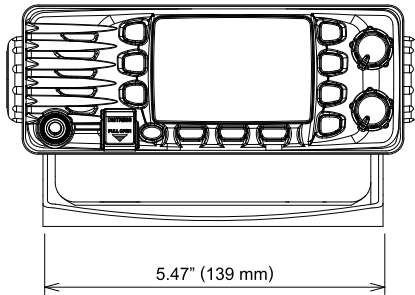
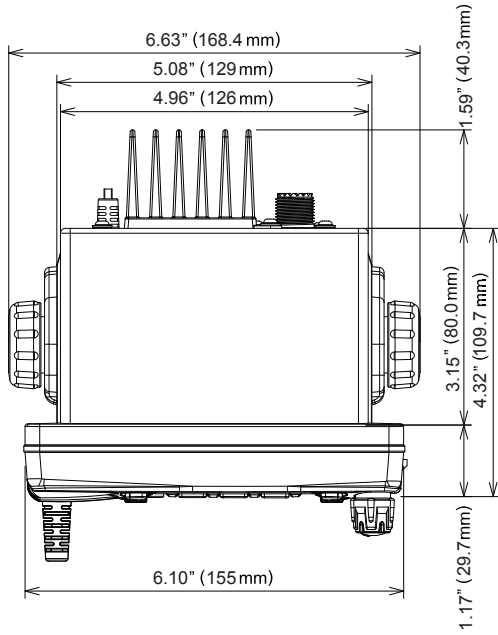

15 FCC RADIO LICENSE INFORMATION

Standard Horizon radios comply with the Federal Communication Commission (FCC) requirements that regulate the Maritime Radio Service.

15.1 STATION LICENSE

An FCC ship station license is no longer required for any vessel traveling in U.S. waters (except Hawaii) which is under 20 meters in length. However, any vessel required to carry a marine radio on an international voyage, carrying a HF single side band radiotelephone or marine satellite terminal is required to have a ship station license. FCC license forms, including applications for ship (605) and land station licenses can be downloaded via the Internet at <http://www.fcc.gov/Forms/Form605/605.html>. To obtain a form from the FCC, call (888) 225-5322.

15.2 RADIO CALL SIGN

Currently the FCC does not require recreational boaters to have a Ship Radio Station License. The USCG recommends the boats registration number and the state to be used when calling another vessel.

15.3 CANADIAN SHIP STATION LICENSING

You may need a license when traveling in Canada. If you do need a license contact their nearest field office or regional office or write:

**Industry Canada
Radio Regulatory Branch
Attn: DOSP
300 Slater Street
Ottawa, Ontario
Canada, KIA 0C8**

15.4 FCC / INDUSTRY CANADA INFORMATION

The following data pertaining to the transceiver is necessary to fill out the license application.

Type Acceptance FCC Part 80
Output Power..... 1 Watt (low) and 25 Watts (high)
Emission..... 16K0G3E, 16K0G2B
Frequency Range..... 156.025 to 163.275 MHz
FCC Type Number..... K6630583X3D
Industry Canada Type Approval 511B-30583X3D

16 FCC NOTICE

NOTICE

Unauthorized changes or modifications to this equipment may void compliance with FCC Rules. Any change or modification must be approved in writing by STANDARD HORIZON.

NOTICE

This equipment has been tested and found to comply with the limits for a Class B digital device, pursuant to Part 15 of the FCC Rules. These limits are designed to provide reasonable protection against harmful interference in a residential installation. This equipment generates, uses and can radiate radio frequency energy and, if not installed and used in accordance with the instructions, may cause harmful interference to radio communications. However, there is no guarantee that interference will not occur in a particular installation. If this equipment does cause harmful interference to radio or television reception, which can be determined by turning the equipment off and on, the user is encouraged to try to correct the interference by one or more of the following measures:

- Reorient or relocate the receiving antenna.
- Increase the separation between the equipment and receiver.
- Connect the equipment into an outlet on a circuit different from that to which the receiver is connected.
- Consult the dealer or an experienced radio/TV technician for help.

17 RF EXPOSURE SAFETY STATEMENT

SAFETY INFORMATION

Your wireless handheld portable transceiver contains a low power transmitter. When the Push-to-Talk (PTT) button is pushed, the transceiver sends out radio frequency (RF) signals. In August 1996, the Federal Communications Commission adopted RF exposure guidelines with safety levels for hand-held wireless devices.

This device is authorized to operate at a duty factor not to exceed 50 % (this corresponds to 50% transmission time and 50 % reception time).

WARNING: To maintain compliance with the FCC's RF exposure guidelines, this transmitter and its antenna must maintain a separation distance of at least 1 inch (2.5 centimeters) from your face. Speak in a normal voice, with the antenna pointed up and away from the face at the required separation distance.

If you use a headset accessory for this radio, with the radio worn on your body, use only the Yaesu belt clip for this transceiver, and ensure that the antenna is at least 1 inch (2.5 centimeters) from your body when transmitting.

Use only the supplied antenna. Unauthorized antennas, modifications, or attachments could damage the transmitter, and may violate FCC regulations.

CONSIGNES DE SECURITE

Votre émetteur-récepteur portatif sans fil contient un émetteur à faible puissance. Lorsque vous appuyez sur le bouton Push-to-Talk (PTT), l'émetteur-récepteur émet des signaux de radiofréquence (RF). En août 1996, la FCC (Commission Fédérale des Communications) a adopté des directives relatives à l'exposition aux RF avec des niveaux de sécurité pour les appareils sans fils portatifs.

Le fonctionnement de cet appareil est autorisé à un facteur d'utilisation ne dépassant pas 50 % (correspondant à 50% de la durée de transmission et 50% de la durée de réception).

AVERTISSEMENT: Pour assurer la conformité avec les directives d'exposition RF de la FCC, cet émetteur-récepteur et son antenne doivent être maintenus à une distance minimum d'un pouce (2,5 centimètre) de votre visage. Parlez avec une voix normale, avec l'antenne dirigée vers le haut et éloignée du visage, à la distance requise.

Si vous utilisez un casque pour cette radio, et que vous portez la radio sur vous, utilisez exclusivement le clip de ceinture Yaesu pour cet émetteur-récepteur, et assurez-vous que l'antenne se trouve à une distance minimum d'un pouce (2,5 centimètres) de votre corps pendant l'émission.

Utilisez exclusivement l'antenne fournie. Les antennes, les modifications ou les accessoires non autorisés peuvent endommager l'émetteur-récepteur et enfreindre les réglementations FCC.

MEMO

THIS DEVICE COMPLIES WITH PART 15 OF THE FCC RULES. OPERATION IS SUBJECT TO THE FOLLOWING TWO CONDITIONS: (1) THIS DEVICE MAY NOT CAUSE HARMFUL INTERFERENCE, AND (2) THIS DEVICE MUST ACCEPT ANY INTERFERENCE RECEIVED, INCLUDING INTERFERENCE THAT MAY CAUSE UNDESIRE OPERATION.

Changes or modifications to this device not expressly approved by YAESU U.S.A. could void the User's authorization to operate this device.

This device complies with Industry Canada license-exempt RSS standard(s). Operation is subject to the following two conditions: (1) this device may not cause interference, and (2) this device must accept any interference, including interference that may cause undesired operation of the device.

Le présent appareil est conforme aux CNR d'Industrie Canada applicables aux appareils radio exempts de licence. L'exploitation est autorisée aux deux conditions suivantes : (1) l'appareil ne doit pas produire de brouillage, et (2) l'utilisateur de l'appareil doit accepter tout brouillage radioélectrique subi, même si le brouillage est susceptible d'en compromettre le fonctionnement.

Under Industry Canada regulations, this radio transmitter may only operate using an antenna of a type and maximum (or lesser) gain approved for the transmitter by Industry Canada. To reduce potential radio interference to other users, the antenna type and its gain should be so chosen that the equivalent isotropically radiated power (e.i.r.p.) is not more than that necessary for successful communication.

Conformément à la réglementation d'Industrie Canada, le présent émetteur radio peut fonctionner avec une antenne d'un type et d'un gain maximal (ou inférieur) approuvé pour l'émetteur par Industrie Canada. Dans le but de réduire les risques de brouillage radioélectrique à l'intention des autres utilisateurs, il faut choisir le type d'antenne et son gain de sorte que la puissance isotrope rayonnée équivalente (p.i.r.e.) ne dépasse pas l'intensité nécessaire à l'établissement d'une communication satisfaisante.

This radio transmitter (identify the device by certification number, or model number if Category II) has been approved by Industry Canada to operate with the antenna types listed below with the maximum permissible gain and required antenna impedance for each antenna type indicated. Antenna types not included in this list, having a gain greater than the maximum gain indicated for that type, are strictly prohibited for use with this device.

Le présent émetteur radio (identifier le dispositif par son numéro de certification ou son numéro de modèle s'il fait partie du matériel de catégorie I) a été approuvé par Industrie Canada pour fonctionner avec les types d'antenne énumérés ci-dessous et ayant un gain admissible maximal et l'impédance requise pour chaque type d'antenne. Les types d'antenne non inclus dans cette liste, ou dont le gain est supérieur au gain maximal indiqué, sont strictement interdits pour l'exploitation de l'émetteur. l'établissement d'une communication satisfaisante.

STANDARD HORIZON

Nothing takes to water like Standard Horizon

Copyright 2014
YAESU MUSEN CO., LTD.
All rights reserved.

No portion of this manual
may be reproduced without
the permission of
YAESU MUSEN CO., LTD.

Printed in China

YAESU USA

6125 Phyllis Drive, Cypress, CA 90630, U.S.A.



E M O 5 8 N 1 0 0