

# AIS *WatchMate*<sup>®</sup> Class B AIS Transponder

WatchMate 850 Model WMX850



## ***Trademarks***

AIS *WatchMate* is a registered trademark of Vesper Marine Ltd. All other product names are trademarks or registered trademarks of their respective owners.

## ***Copyright Notice***

Copyright © 2012, Vesper Marine Ltd. All rights are reserved.

Unless otherwise indicated, all documentation and operating software contained within this product or distributed with this product is copyrighted by Vesper Marine Ltd. All rights are reserved.

Except for short quotations in a review, no portions of this document or the software contained within this product may be reproduced or transmitted in any form or by any means without prior written permission of Vesper Marine Ltd.

Portions of this product may use software licensed under the GNU GPL or a modified GPL. Source code for the applicable software is available upon request from Vesper Marine Ltd.

## ***Technical Accuracy***

The information contained in this document is to the best of our knowledge correct at the time of publication. However, we reserve the right to change specifications, installation and operating instructions without notice as part of our ongoing product development and improvement programs.

No liability can be accepted for any inaccuracies or omissions in this document, or any other document provided by Vesper Marine Ltd, although every effort has been made to ensure it is as complete and accurate as possible.

## ***General Warnings***

The AIS *WatchMate* works in cooperation with other vessels and systems such as transponders and GPS. The accuracy of this device and the AIS system can be affected by many factors, including equipment failure or defects, environmental conditions and incorrect installation, handling or use. Vesper Marine does not warrant that this product is error-free. It is the user's responsibility to exercise common prudence and navigational judgment. This device should not be relied upon as a substitute for such prudence and judgment. Always maintain a permanent watch so that you can respond to situations as they develop.

The prudent mariner will not rely on a single aid to navigation. The user should verify the information obtained from the AIS *WatchMate* is in accordance with expected situations and conditions. The information is not guaranteed to be accurate or reliable and the AIS *WatchMate* is not a substitute for proper seamanship.

**Vesper Marine Limited cannot be held liable for any injury, damage or loss caused by, during, or because of the installation, use or inability to use this device. The AIS *WatchMate* is to be installed and used entirely at your own risk. By installing and/or using the AIS *WatchMate* you fully accept this risk and agree to hold Vesper Marine Limited harmless.**

### ***VHF Antenna Warning***

**CAUTION:** Never operate this device unless it is connected to a suitable VHF antenna or Vesper Marine AIS/VHF antenna splitter. Transmitting without an antenna may damage this device.

### ***RF Emissions Warnings***

**WARNING:** Changes or modifications not expressly approved by Vesper Marine could void the user's authority to operate this equipment.

**CAUTION:** This device generates and radiates electromagnetic energy. This device must be installed and operated according to the instructions contained in this manual. Failure to do so may result in product malfunction and / or exposure to potentially harmful levels of radio frequency radiation.

**CAUTION:** The system has a Maximum Permissible Exposure (MPE) radius of 1m from the antenna. This has been determined assuming the maximum power of the transmitter and using a standard half-wave monopole VHF antenna with a maximum gain of 3dBi and termination impedance of 50 ohms.

When installing the antenna and operating the equipment consider the following:

- The antenna should be mounted as high above deck as possible.
- Higher gain VHF antennas will require a larger MPE radius.
- Do not operate the unit when anyone is within the MPE radius of the antenna.
- The antenna should not be collocated or operated in conjunction with any other transmitting antenna.

This device complies with Part 15 of the FCC Rules. Operation is subject to the following two conditions: (1) this device may not cause harmful interference and (2) this device must accept any interference received, including interference that may cause undesired operation.

This device complies with Industry Canada license-exempt RSS standard(s). Operation is subject to the following two conditions: (1) this device may not cause interference, and (2) this device must accept any interference, including interference that may cause undesired operation of the device.

This device complies with RSS-310 of Industry Canada. Operation is subject to the condition that this device does not cause harmful interference.

**INDUSTRY CANADA WARNING:** To satisfy RF exposure requirements for mobile transmitting devices, a separation distance of 1 metre or more should be maintained between the antenna of this device and persons during device operation. To ensure compliance, operations at closer than this distance is not recommended.

The antenna used for this transmitter must not be co-located in conjunction with any other antenna or transmitter.

This device has been designed to operate with an antenna having a maximum gain of 3dBi. Antennas having a gain greater than 3dBi are strictly prohibited for use with this device. The required antenna impedance is 50 ohms.

To reduce potential radio interference to other users, the antenna type and its gain should be chosen that the equivalent isotropically radiated power (EIRP) is not more than that required for successful communication.

Pour satisfaire aux exigences d'exposition aux fréquences radio pour les appareils mobiles de transmission, une distance de 1 mètre ou plus doit être maintenue entre l'antenne de ce dispositif et les personnes pendant son fonctionnement. Pour assurer la sécurité, les opérations plus près de cette distance ne sont pas recommandées.

L'antenne utilisée pour ce transmetteur ne doit pas être co-localisés avec toute autre antenne ou transmetteur.

Ce dispositif a été conçu pour fonctionner avec une antenne ayant un gain maximal de 3dBi. Les antennes ayant un gain supérieur à 3dBi sont strictement interdits pour une utilisation avec cet appareil. L'impédance d'antenne requise est de 50 ohms.

Pour réduire le risque d'interférence aux autres utilisateurs, le type d'antenne et son gain doivent être choisis pour que la puissance isotrope rayonnée équivalente (PIRE) ne soit pas supérieure à celle requise pour une communication réussie.

### ***MMSI Programming Warning***

**IMPORTANT:** In most countries the operation of an AIS unit is included under the vessel's marine VHF license provisions and the vessel on which this device is to be installed may be required to possess a current VHF radiotelephone license which lists the AIS system and the vessel Call Sign and MMSI number.

**An MMSI number is required in order for this device to operate as a transmitter.**

Please contact the relevant authority in your country for more information.

### ***For Customers in the USA***

This device must be programmed with data corresponding to the vessel on which it will be installed. Programming must be carried out by a Vesper Marine dealer. The included instructions contain information on how to verify the correct programming.

**WARNING:** It is a violation of the rules of the Federal Communications Commission to input an MMSI that has not been properly assigned to the end user, or to otherwise input any inaccurate data in this device

### ***GPS Antenna***

The *AIS WatchMate* Transponder has a built-in GPS patch antenna. This antenna requires an unobstructed view of the sky. The performance of the internal GPS antenna is also highly dependent on the environment in which the device is mounted. The antenna performance may be significantly reduced if the *AIS WatchMate* is installed on, under, or near large metal structures.

If you are mounting the display in a location which will not provide adequate GPS signal coverage then you must install a dedicated external GPS antenna. You cannot share a GPS or GPS antenna. See the GPS Installation section for more information on installing an external GPS antenna.

**WARNING:** If an external antenna is required, only use a Vesper Marine GPS antenna. Performance cannot be assured with any other antenna. Any damage caused by using an incompatible GPS antenna is not covered under your warranty.



**CAUTION:** Do not allow an external GPS antenna or its connectors to come in contact with any metal objects, such as stanchions, railings, metal hull or deck, etc. Always ensure the external GPS antenna is kept isolated from all conductive material. You may use the plastic base or pole mounts for this purpose. Any damage caused by a non-isolated GPS antenna installation is not covered under warranty.

### **Compass Safe Distance**

Mount your AIS WatchMate transponder at least 0.6m (2 feet) from any compass. Test your compass to verify that it operates properly when this device is operating.

### **Electronic Waste Recycling**



Various regional and national regulations exist regarding the recycling of certain electronics. Please consult your local authorities or contact Vesper Marine for recycling information.

### **Care Notice**

To provide protection against the damaging effects of UV light, it is recommended to replace the cover when not in use.

Take care when cleaning to avoid damage:

- Be careful when wiping the display screen to avoid scratching. Use a clean soft damp cloth.
- Do not use acid, ammonia, solvents, or any abrasive products.

### **Declaration of Conformity**

Vesper Marine declares that this product is in compliance with the essential requirements and other provisions of the R&TTE directive 1999/5/EC.

For details and a copy of the Declaration of Conformity contact Vesper Marine or see [www.vespermarine.com/compliance](http://www.vespermarine.com/compliance).

This product is for use worldwide, including the following European countries:

AT	BE	BG	CH	CY	CZ	DE	DK
EE	ES	FI	FR	GR	HU	IE	IS
IT	LI	LT	LU	LV	MT	NO	NL
PL	PT	RO	SE	SI	SK	UK	

This device is also approved for use in the United States, Canada, Australia and New Zealand.



## **Table of Contents**

<b>Trademarks</b> .....	<b>2</b>
<b>Copyright Notice</b> .....	<b>2</b>
<b>Technical Accuracy</b> .....	<b>2</b>
<b>General Warnings</b> .....	<b>2</b>
VHF Antenna Warning .....	3
RF Emissions Warnings .....	3
MMSI Programming Warning .....	5
GPS Antenna .....	5
Compass Safe Distance.....	6
Electronic Waste Recycling.....	6
Care Notice.....	6
<b>Standards</b> .....	Error! Bookmark not defined.
<b>Declaration of Conformity</b> .....	<b>6</b>
<b>Table of Contents</b> .....	<b>7</b>
<b>Glossary</b> .....	<b>9</b>
<b>Introduction</b> .....	<b>10</b>
<b>Important Information</b> .....	<b>11</b>
<b>Specifications</b> .....	<b>12</b>
<b>Installation</b> .....	<b>15</b>
Requirements.....	15
Mounting the Display.....	15
VHF Antenna Installation.....	15
GPS Antenna Installation .....	16
Connectors.....	17
Power/Data Cable Wiring .....	17
Minimum Connections.....	18
Connecting an Optional Heading Sensor or Chart Plotter.....	18
Connecting an Optional External Alarm.....	19
Using a Relay to Control a High Current External Device .....	19
GPS Backup Power .....	20
Using the USB Connection.....	20
Configuration: Entering Your MMSI and Vessel Details.....	21
Using the vmAIS Configuration Program .....	23
<b>Power Button</b> .....	<b>25</b>
One Minute Startup Time .....	25
Initial Profile Setting .....	25
<b>Buttons</b> .....	<b>25</b>
<b>Display Screens</b> .....	<b>26</b>
Home Page – Situation Display .....	26
Main Menu .....	28
Target List.....	30
Target Display.....	31
CPA Graphical Display.....	33
Safety Message List.....	34
Safety Message Display.....	35
Fleet List .....	36

Weather Reports .....	36
GPS Position Display .....	36
GPS Status Display .....	36
AIS Status Display .....	37
Using the Anchor Watch.....	39
Displaying Information About your AIS WatchMate .....	42
Placing Individual DSC Calls .....	43
<b>Target Filters .....</b>	<b>44</b>
<b>Target Alarms.....</b>	<b>44</b>
Guard Alarm.....	45
CPA Alarm .....	45
<b>Profiles.....</b>	<b>46</b>
Harbor.....	47
Coastal.....	47
Offshore .....	47
Anchor .....	47
<b>Setup Mode .....</b>	<b>48</b>
Target List Settings .....	48
Alarm Settings.....	49
Navigation Settings .....	49
Display Settings .....	50
Preference Settings.....	50
AIS Transponder .....	51
I/O Port Settings.....	51
Additional Settings .....	51
Settings Associated with Each Profile .....	51
<b>Built-in Integrity Test (BIIT) .....</b>	<b>55</b>
<b>Device Alerts .....</b>	<b>56</b>
<b>Troubleshooting.....</b>	<b>57</b>
Examining Received NMEA Data.....	58
<b>Warranty - North America.....</b>	<b>59</b>
<b>Warranty - Australia and New Zealand .....</b>	<b>60</b>
<b>Warranty - European Union.....</b>	<b>61</b>
<b>Obtaining Warranty Service .....</b>	<b>62</b>



## Glossary

AIS	Universal Shipborne Automatic Identification System. A system of transponders installed on vessels which send continuously updated navigation information. An AIS receiver or transponder is used to monitor these transmissions and the <i>AIS WatchMate</i> is used to display this information and trigger alarms when there is a risk of collision.
BRG / Bearing	The location of another vessel typically expressed as true or magnetic degrees. May also be expressed as relative degrees from your vessel's heading.
Class A/B	There are two classes of AIS transponders. Class A are used on vessels which have mandatory requirements to carry AIS transponders. Class B are used on vessels for which AIS transponders are optional.
COG	Course over ground. The course a vessel is making which is not necessarily the same as the vessel's heading.
CPA	Closest point of approach. The nearest distance in nautical miles two vessels will come to one another if they both maintain their current course and speed.
Filter	A set of criteria used to determine if a target should be included in the target list, such as its range or speed.
GPS	Global Positioning System. Used to provide your vessel's current position, course, and speed.
IMO	International Maritime Organization. A unique IMO number is permanently assigned to each ship and may be used to find additional registration information for a particular vessel.
HDG / Heading	The course a vessel is steering.
MMSI	Maritime Mobile Service Identity. Used as a radio identifier for each vessel with digital radios such as an AIS transponder. Vessels may also transmit their name to facilitate easier identification. These transmissions occur at a different interval than position information and as a result the name may not be immediately available. All AIS transponders require a unique MMSI. The <i>AIS WatchMate</i> will not transmit until you configure your MMSI.
Profile	A group of settings. Profiles allow you to organize filter and alarm settings and activate them together when your navigation situation changes.
RNG / Range	The distance in nautical miles between two vessels.
ROT	Rate of turn. The number of degrees a vessel is turning over a specified amount of time. Usually per minute but may also be per 30 seconds.
SOG	Speed over ground. The actual speed in knots a vessel is making over the ground.
Target	Another vessel for which AIS information has been received.
Target List	The set of all targets which meet the filter requirements.
TCPA	The time until the closest point of approach.

## Introduction

The *AIS WatchMate* is a device which provides information to assist in avoiding collisions at sea. It works by receiving and transmitting data as part of the Universal Shipborne Automated Identification Systems (AIS). The AIS system uses two dedicated VHF channels designated for this purpose and with the installation of the *AIS WatchMate* to receive signals from other AIS-equipped vessels you can view this information. In addition, your vessel data is transmitted to other AIS-equipped vessels within range.

The AIS system provides several types of messages from other vessels and base stations. Each type of message is sent at a different interval based on the navigation status of the vessel. Vessels moving or turning faster send out navigation information more frequently than vessels at anchor. Data received from other vessels is split between two types: navigation information and voyage information. Vessel navigation and position information is generated by an on-board GPS or similar navigation device and is sent frequently. Voyage information contains the ship's name, its destination, size, type, cargo, etc. This data is typically only sent once every few minutes.

The *AIS WatchMate* provides a means to view how recently information has been received from each vessel and this data is designed to help you determine how accurate and dependable the information may be at any given time.

The *AIS WatchMate* refers to each vessel other than your own as a **target**. Associated with each target are the most recently received position, navigation, and voyage information. Also associated with each target are computed data to help determine the risk of a collision.

The targets are contained within a **target list**. The *AIS WatchMate* allows you to view the target list and also examine each target in detail. By default, the target list is ordered by **priority**. You can disable priority ordering if you wish. However, by viewing targets in a prioritized fashion you can focus your interest on the targets most likely to pose a collision risk first. Similarly, whenever a target triggers an alarm you don't have to scroll to find it. The target is displayed immediately with an indication of the cause of the alarm.

The *AIS WatchMate* utilizes data from its built-in GPS receiver to assist you in determining the risk of a collision with each target. Multiple targets are automatically and continuously tracked simultaneously. Alarms are associated with each individual target and when an alarm is muted for one target it does not affect any other targets which might also trigger alarms.

The computed data for each target includes the following items. Note that in order to compute this data your vessel's current position, course, and speed are required. The *AIS WatchMate* receives this information continuously from its built-in GPS.

**If the built-in GPS does not have a valid "fix" then this information will not be computed and displayed. In addition, your own information will not be transmitted to other vessels.**

Range	The <i>AIS WatchMate</i> computes the range (distance in nautical miles) to each target and displays it along with the target information.
Bearing	The bearing to each target is also displayed. The bearing may be shown as magnetic to facilitate quick visual identification using a compass or binoculars. However, if you wish you can change a setting to display bearings in degrees true or relative to your vessel's current heading.

Closest point of approach (CPA)	The CPA is the closest a target will come to your vessel if both your vessel and the target maintain their existing course and speed. It is displayed in nautical miles to the nearest tenth or hundredth. As either your vessel or the target changes its course or speed, the CPA (along with all other computed data) is automatically recomputed and redisplayed.
Time until CPA (TCPA)	This is the amount of time until the CPA will occur. It indicates how much time is available before the two vessels will reach their nearest distance to each other. It is displayed in minutes and seconds or just minutes if the time exceeds one hour.

The *AIS WatchMate* automatically updates these computed values whenever new information is received from a target and also whenever your vessel's position, speed, or course changes. The information displayed is always the most up-to-date available but because the AIS and GPS systems do not guarantee the frequency of updates from each vessel it can be inaccurate and can become further inaccurate as time progresses without continuous updates from both vessels.

**Always check to see how long it has been since an update was received from a vessel when relying on this information, particularly in close situations.** You do this by examining the “age” of the target. See the target display section for more details.

The AIS system also includes messages broadcast from other vessels and shore stations which may be used to send navigation warnings, weather information, etc. The *AIS WatchMate* displays this information on the **messages** page and by default is configured to sound an alert when a message is received.

We are always interested in your suggestions, comments, ideas, and criticisms. We continuously strive to improve our products and would greatly enjoy hearing from you.

Please contact us through our website [www.vespermarine.com](http://www.vespermarine.com) or via e-mail to [support@vespermarine.com](mailto:support@vespermarine.com).

### ***Important Information***

Before using the *AIS WatchMate*, it is important that you read and fully understand this owner's manual and installation instructions.

Although more vessels continue to install AIS transponders it is important to remember that **not all vessels carry AIS transponders**. The *AIS WatchMate* can only display information received from properly equipped and operated vessels. In addition, the *AIS WatchMate* relies on the accuracy of the GPS system. A failure or compromised operation of either of these systems will reflect on the accuracy of the data displayed and alarms triggered by the *AIS WatchMate*.

## Specifications

Size (not including cables or mounting bracket)	208mm wide x 135mm high x 76mm depth (8 3/16" x 5 5/16" x 3")
Flush mount thickness	17mm (11/16")
Mounting template	Included
Power supply	10-32 VDC 1A max, 3W nominal
Environmental	Watertight (USCG CFR-46, IPx7)
Operating temperature	-25°C to +55°C (-13°F to 131°F)
Storage temperature	-25°C to +80°C (-13°F to 176°F)
LCD panel	125mm (5") FSTN 320x240 backlit
LCD light level	Off and multiple levels of brightness
Serial data	1 USB port (isolated), 1 NMEA input (isolated RS422), 1 NMEA output (non-isolated RS422)
Data port impedance	NMEA input: 96k ohm, NMEA output: 28 ohm
Baud rates	4800 and 38400
NMEA output	RMC, GSV, GSA, GGA, GLL, VTG, VDO, VDM, TXT, DSC
NMEA input (optional)	ALR, HDG, HDM, HDT
AIS messages displayed	All Class A and Class B position reports, voyage data, static data, aids to navigation, search and rescue, SART, meteorological / hydrographic and broadcast safety messages (1,2,3,5,8,9,14,18,19,21,24A,24B)
Number of receivers	2 AIS, 1 DSC (timeshared)
Number of transmitters	1 AIS
Receive frequency range	156.025 – 162.025 MHz
Transmit frequency range	161.500 – 162.025 MHz
Channel bandwidth	25 kHz
Sensitivity	-107 dBm < 20% PER
Power output	33 dBm (2W)
GPS	50 channel
GPS sensitivity	-159dBm tracking & navigation -142dBm acquisition
GPS SBAS support	WAAS, EGNOS, MSAS, GAGAN
Maximum number of simultaneous targets displayed	150 (if more, then the lowest priority target is replaced)
Maximum number of simultaneous broadcast safety messages displayed	30 (if more, then the oldest message is replaced)
Maximum number of simultaneous meteorological stations displayed	30 (if more, then the oldest received meteorological information is replaced)

Maximum fleet size	50 vessels
External alarm	Maximum current 150mA. Use an external relay if more is required.
Power/data connector	10 pin circular. 2m cable included.
USB connector	Mini USB. (USB 2.0)
GPS antenna connector	TNC. Optional GPS antenna available (50 ohm, 3.3 VDC)
VHF antenna connector	SO-239
VHF antenna required	PL-259 connector. 50 ohm, max 2:1 VSWR

Vesper Marine is committed to continuously improving our products. As a result, specifications may change and there may also be differences between the product and this manual.

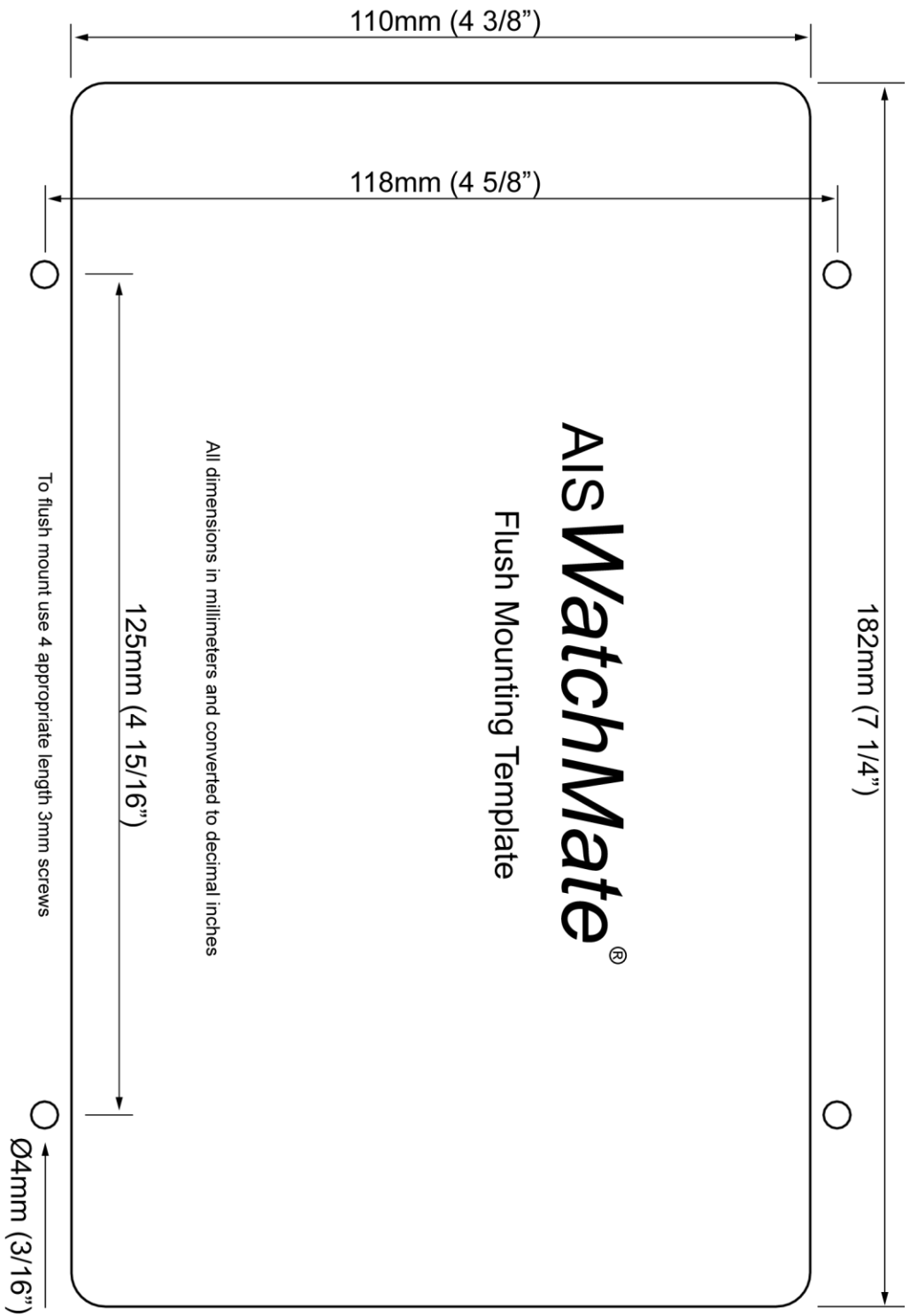

## ***Installation***

### ***Requirements***

The *AIS WatchMate* requires a suitable VHF antenna which must be supplied by the user and a clear view of the sky for the built-in GPS or an external GPS antenna.

The following are required for installation:

- Various countries have regulations requiring a VHF radio license to operate an AIS transponder. Check with your local authorities to determine the requirements for your area.
- You must have an assigned MMSI and Call Sign for your vessel. If you do not have an assigned MMSI, contact the relevant authority in your country. You must enter a valid MMSI number into this device.

**Once you enter the MMSI number it cannot be changed. If you need to change the MMSI, please contact an authorized dealer or Vesper Marine.**

- A suitable VHF antenna or Vesper Marine AIS/VHF Antenna Splitter. Performance cannot be assured if you use any other antenna splitter. The use of an improper splitter may damage your *AIS WatchMate* and void your warranty.
- If you are not able to mount the unit with an unobstructed view of the sky or if your mounting location and / or other equipment interferes with the built-in GPS antenna, then an optional external GPS antenna is required. You must use a Vesper Marine dedicated GPS antenna which cannot be shared with any other equipment. However, the GPS data produced by the *AIS WatchMate* is available for use by other optional equipment connected to the NMEA output.

### ***Mounting the Display***

Your *AIS WatchMate* is supplied with a trunnion mounting bracket if you wish to mount it above or below a shelf or other support. You may also mount the unit by cutting a hole in an instrument panel and mounting it flush. Included is a template you can use to cut the hole and drill four additional holes for the required fasteners. A gasket is also included to seal the unit against your instrument panel.

**Do not disassemble the unit or remove the screws which hold it together.** The unit is sealed and disassembly will void the warranty. If you require service or assistance please contact your dealer or Vesper Marine.

### **VHF Antenna Installation**

The *AIS WatchMate* must be connected to a suitable VHF antenna or Vesper Marine AIS/VHF Antenna Splitter. Performance cannot be assured if you use any other antenna splitter. The use of an improper splitter may damage your *AIS WatchMate* and void your warranty.

When installing the VHF antenna please take into consideration:

- The type of antenna should be an omnidirectional VHF antenna designed for the marine band (156-162 MHz).
- There are AIS-frequency adapted antennas available. You may also use a standard marine VHF antenna.
- The antenna must be dedicated and not connected to any other equipment.

- Place your antenna as high as possible and at least 2-3 metres (6-10 ft) above the water surface.
- Place your VHF antenna as far as possible from other antennas and metal structures, especially other VHF, HF and radar antennas. It is not recommended to place the VHF antenna directly alongside a mast or another VHF antenna such as on a mast-head.

### **GPS Antenna Installation**

The *AISWatchMate* has an internal GPS patch antenna facing upwards. This antenna requires an unobstructed view of the sky. However, the performance of the internal GPS antenna is also highly dependent on where you place your *AISWatchMate*. For example, you may find that it works well under a non-metallic dodger or spray hood but performance may be reduced if the *AISWatchMate* is installed on, under, or near metal structures. If you are mounting the display in a location which will not provide adequate GPS signal coverage then you must install a dedicated GPS antenna. You cannot share a GPS or GPS antenna.

When installing an external GPS antenna please take into consideration:

- Vesper Marine has available an optional external GPS antenna designed specifically for use with the *AISWatchMate*. Performance cannot be assured unless you use a Vesper Marine GPS antenna.
- The GPS antenna must be kept isolated from conductive objects at all times. See the caution notice below.
- If you choose to use another GPS antenna, only use a 3.3VDC active antenna that contains a low noise amplifier. Any damage caused by using an incompatible GPS antenna is not covered under your warranty.
- The GPS antenna should be situated so it has an unobstructed view of the sky above.
- Do not place the GPS antenna near or in the path of radar or HF antennas.
- It is not necessary to change any settings when using the optional Vesper Marine GPS antenna. Simply connect it to the TNC connector on the back of the unit.

Considerations when using the internal GPS patch antenna:

- The *AISWatchMate* should be situated so it has no metal obstructions over the top. The antenna is located in the back “bulge” area at the top of the unit facing upwards.
- Avoid placing your hand or body over the antenna area as this may reduce satellite signal strength.

**Hint:** Use the *GPS Status* screen to view satellite signal strengths which will assist in determining the best location for the unit or antenna.



**CAUTION:** Do not allow an external GPS antenna or its connectors to come in contact with any metal objects, such as stanchions, railings, metal hull or deck, etc. Always ensure the external GPS antenna is kept isolated from all conductive material. You may use the plastic base or pole mounts for this purpose. Any damage caused by a non-isolated GPS antenna installation is not covered under warranty.



## Connectors

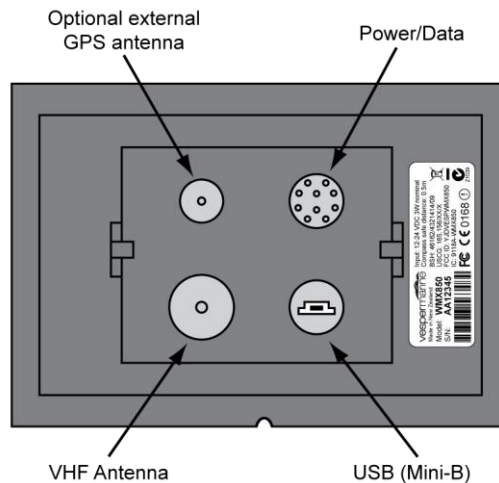

### Power/Data Cable Wiring

A 2m (6.5') power/data cable with attached connector is supplied with the AIS *WatchMate*. You may extend this cable as necessary. It is recommended that any splices made in the cable be done in a weather tight area to prevent corrosion and failed connections. Consult a marine electronics technician if you have any difficulties or concerns about installation.

**Insert the connector into the back of the display firmly and completely, fully engaging the locking ring to ensure a watertight seal.**

Red	<b>DC positive (+) (12-24 volts).</b> Ensure there is a circuit breaker or fuse rated at 2A (max) in the positive power connection. It is recommended to add a fuse if necessary. If you must extend the power connections, it is recommended to use high quality pre-tinned marine grade wire which is <b>at least 16 AWG</b> (1.5mm <sup>2</sup> ).
Black	<b>DC negative (-).</b>
Gray	<b>NMEA data output positive.</b> Connect this wire to the NMEA data input (A or +) on another device such as a chart plotter or radar.
Yellow	<b>NMEA data output negative.</b> Connect this wire to the NMEA data input (B or -) on another device such as a chart plotter or radar.
Green	<b>NMEA data input positive.</b> Connect this wire to the NMEA data output (A or +) on another device, such as a heading sensor.
White	<b>NMEA data input negative.</b> Connect this wire to the NMEA data output (B or -) on another device, such as a heading sensor.
Blue	<b>External alarm.</b> When the alarm is triggered and the external alarm is enabled this wire will have the input voltage (from the red wire) applied. You can use this to provide power to an external buzzer, light or other signal device.  Maximum current is 150mA. If your device requires more current then an external relay must be used.
Others	All other wires are not used. Leave them unconnected.

## Minimum Connections

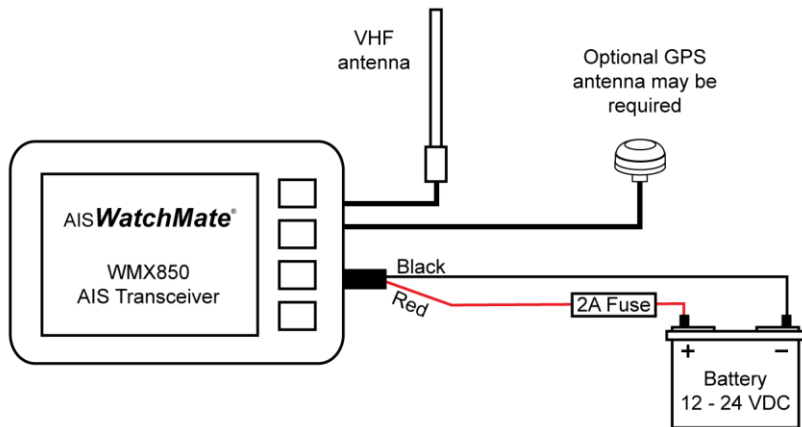

## Connecting an Optional Heading Sensor or Chart Plotter

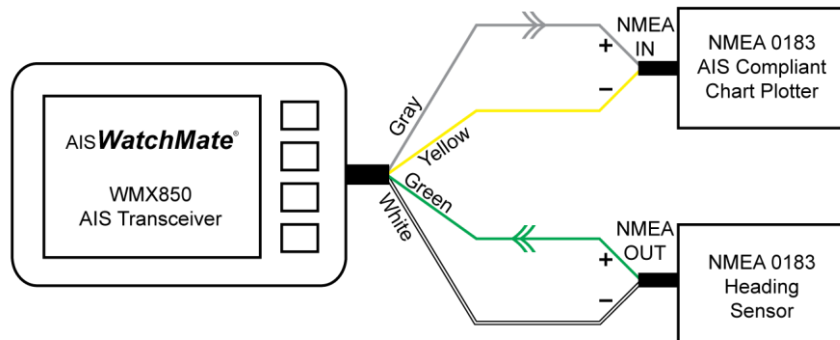

## Connecting an Optional External Alarm

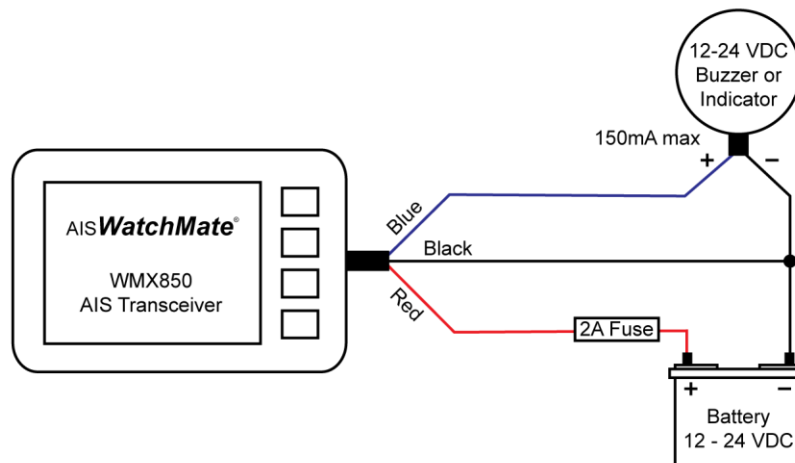

## Using a Relay to Control a High Current External Device

When your external device requires more than 150mA you must use an external relay. Ensure a spike suppression diode (eg. 1N4001) is either provided by the relay or fitted externally.

You should also provide a fuse of the appropriate value to protect against overload.

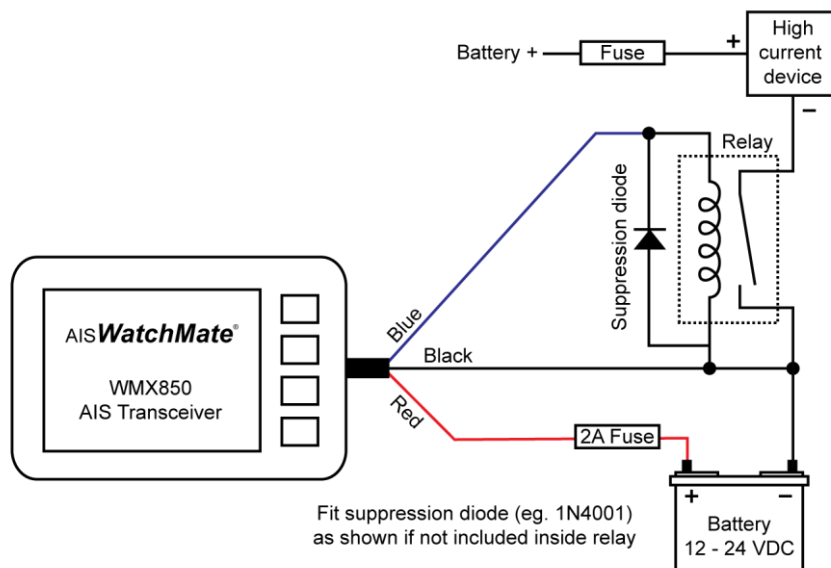

### ***GPS Backup Power***

To speed the time-to-first-fix, do not disconnect or switch off the power supply to the *AIS WatchMate*. If you do switch off the power supply it may take longer for the built-in GPS to acquire satellite data and a position fix. You can switch the unit off using the power button on the front and it will continue to maintain the GPS almanac data as long as the power supply to the *AIS WatchMate* is maintained.

An extremely small amount of power is used to maintain the GPS data so it should not have any significant effect on your battery. However, if you wish to completely turn off the *AIS WatchMate*, such as when storing your vessel for an extended time, disconnect or switch off the power supply.

### ***Using the USB Connection***

If you wish to connect your *AIS WatchMate* to your PC for use with charting or other software, use a USB cable with a Mini-B (male) connector. One has been included with your *AIS WatchMate*. These are also widely available from computer stores.

Vesper Marine has available an optional waterproof USB cable which is highly recommended if your *AIS WatchMate* is installed in a location where it is possible to get wet.

The *AIS WatchMate* utilizes standard drivers that are supplied with Windows, but in case the "Found New Hardware Wizard" cannot locate the proper drivers, they are also included on the supplied CD.

The driver creates a "virtual COM port" which will be displayed the first time the *AIS WatchMate* is plugged into your computer.

**You will need to configure your software to use this port (eg. COM3) at 38,400 baud.**

**Configuration: Entering Your MMSI and Vessel Details**

Your vessel data, including MMSI number, must be entered into the *AIS WatchMate*. Your MMSI may have been entered already by your dealer. Once entered, this information will be retained and it is not necessary to enter it again.

Until this information has been entered, the *AIS WatchMate* will receive other vessel's AIS data but will not transmit yours.

To program your vessel data or check that it has been programmed properly, select **Setup** from the main menu and select **AIS Transceiver**. Choose the option for **Your vessel AIS details**.

Your vessel AIS details

MMSI: 0 0 0 0 0 0 0 0 ▲

Type:  ▼

Name: ▼

Call sign: Modify

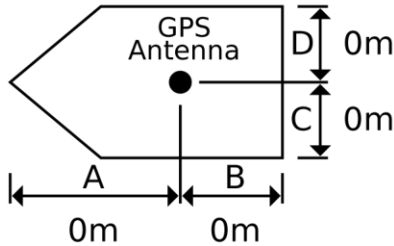
OK

▲	Move the selection box to the previous field
▼	Move the selection box to the next field
Modify	Enter a new value for the selected field
OK	Save your changes and exit configuration

To enter or change data in a field, use the arrow buttons to position the field selection box over the appropriate data and press the **Modify** button. The field becomes active and the current character position is indicated as shown below.

Your vessel AIS details

MMSI: **3** 0 0 0 0 0 0 0 0

Type: Pleasure craft

Name:

Call sign:

0m      0m      0m      0m

▲	Increase the value at the current character position
▼	Decrease the value at the current character position
▶	Move to the next character position
Enter	Complete the field entry and return to the previous screen allowing you to select another field to modify

If you make a mistake and want to go back to the previous character position, press the **Enter** button to accept the value and then press the **Modify** button to change it again.

When you have finished entering your configuration data, press the **OK** button to save your changes.

### Important Notice

You cannot change the MMSI number once it has been saved in the unit. Enter the number carefully and only use an assigned MMSI for your vessel. If you need to change the MMSI number in your unit you must contact an authorized dealer or Vesper Marine.

**The AIS WatchMate will not transmit your data until your MMSI has been entered.**

When you enter your MMSI number and press the OK button to save it, the following screen is displayed. Press the Yes button to proceed and save your changes. Press the No button to return to the configuration screen.

If you wish to abort the configuration operation without saving any changes, press and hold the power button for 2 seconds.

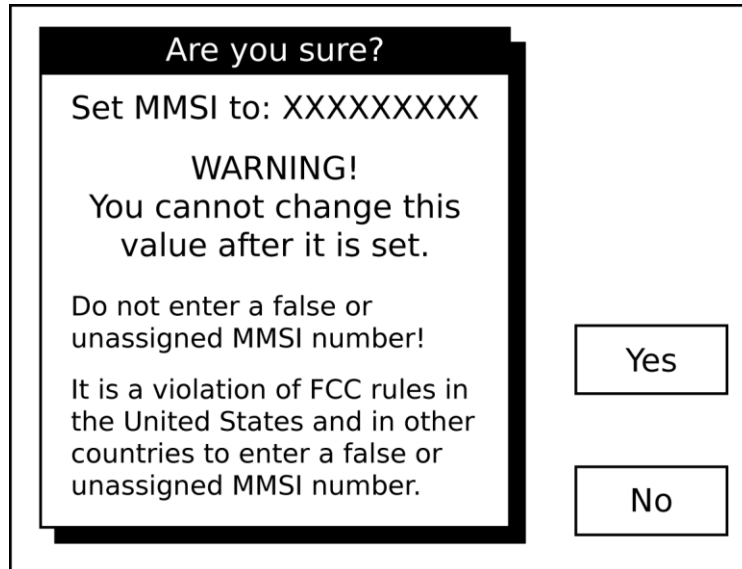

### **Using the vmAIS Configuration Program**

An alternative method for entering your MMSI and vessel details is the **vmAIS** program supplied on the included CD. You can copy this program to your PC or run it directly from the CD by clicking on "*Configuration Utility*".

**Note:** This program only works with Microsoft Windows XP, Vista, 7 or later. For any other operating system, you must use the on-screen configuration method described above.

1. Connect your *AIS WatchMate* to your PC using the supplied USB cable.
2. Connect DC power (12-24 volts) to your *AIS WatchMate*.
3. Press the power button to turn on your *AIS WatchMate*.
4. If this is the first time you have connected your *AIS WatchMate* to the PC, Microsoft Windows will install the necessary drivers. Most versions of Windows come with the drivers, but in the case where Windows cannot locate the driver, you'll find them on the included CD. You can install them from the CD directly, by clicking on "*Install USB Driver*".
5. Once the drivers have been successfully installed, a "virtual COM port" will be created for your *AIS WatchMate*. The port number will be displayed by Microsoft Windows after the successful completion of the driver installation. The port number will stay the same regardless of which USB socket you plug in your *AIS WatchMate*.
6. Select the appropriate COM port at the top of the vmAIS window and click the "Connect" button. If you receive an error, ensure you have selected the correct COM port and your *AIS WatchMate* is switched on. Due to the way Microsoft Windows works, you may need to unplug it from the USB port and plug it back in again the first time you use it.
7. Once you have successfully connected to your *AIS WatchMate*, you can enter your vessel details using this screen:

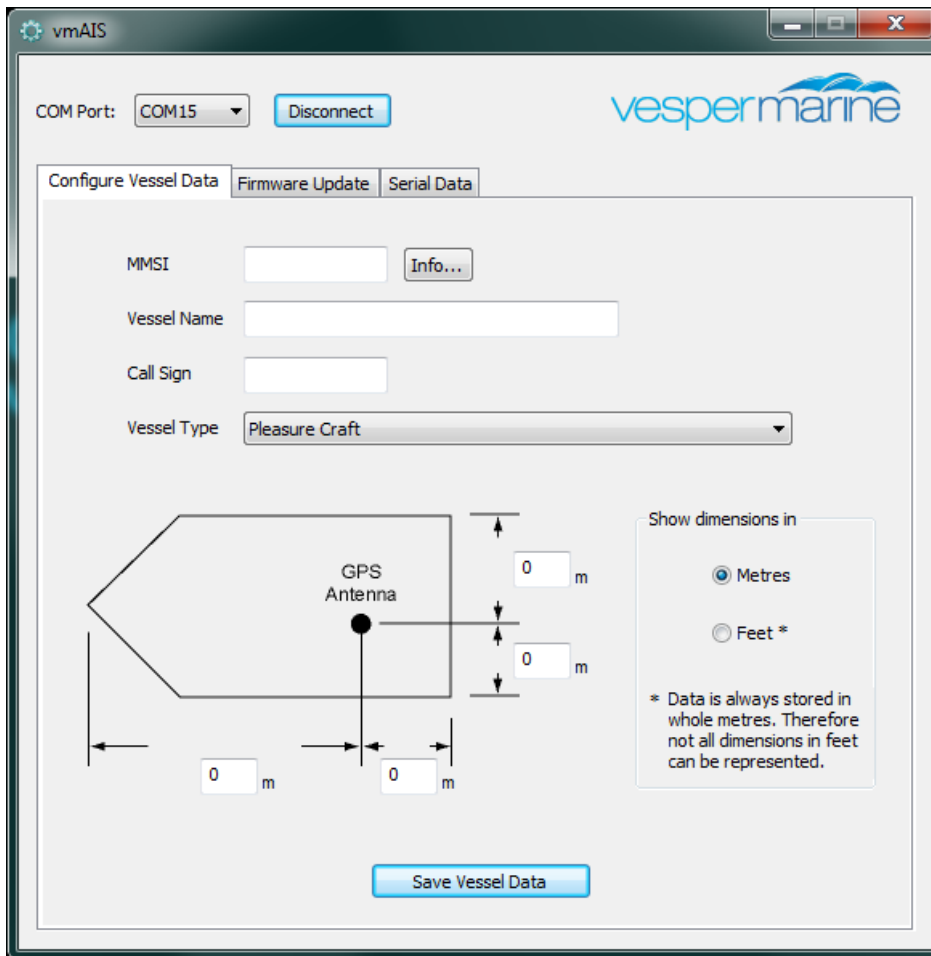

- When all the information is correct, click on the “Save Vessel Data” button. You will receive the following confirmation. Click “OK” if you wish to proceed.

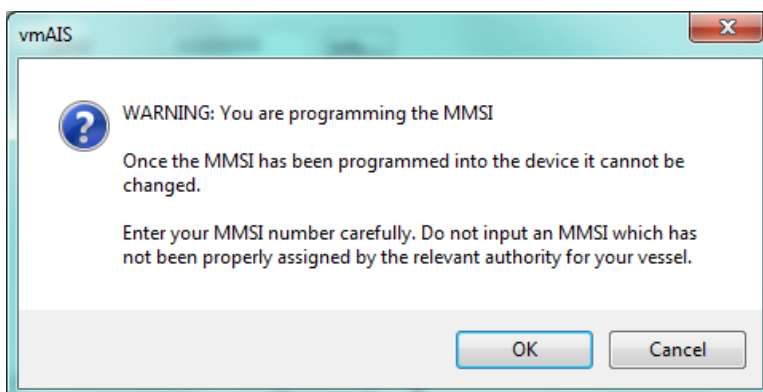

- When you are finished, click the “Disconnect” button.



## ***Power Button***

Press the power button momentarily to turn on the *AIS WatchMate*. Press and hold the power button for 2 seconds to turn it off.

While the *AIS WatchMate* is turned on, pressing the power button momentarily allows you to change the display brightness.

## ***One Minute Startup Time***

The *AIS WatchMate* will not begin to transmit for one minute after it has been switched on. This startup time is required to determine background noise levels on the AIS frequencies.

## ***Initial Profile Setting***

When you press the power button to turn on the *AIS WatchMate*, you will be prompted to select the current profile. This allows you to switch profiles before any alarms are triggered.

**No alarms will be triggered while the profile selection window is displayed. You must select a profile and press the OK button.**

## ***Buttons***

The *AIS WatchMate* is designed to be simple and intuitive to operate. In addition to the power button there are only four buttons. Next to each button on the screen is a box indicating the button's function. If no box appears next to a button then the button performs no function at that time.

## Display Screens

### Home Page – Situation Display

The home page displays targets using a graphical situation display similar to a radar.

The display is oriented either Heading-Up or North-Up depending on the profile and settings. If heading data is not available for your vessel, then it is oriented course-up or north-up. The heading or course may be displayed in magnetic or true degrees depending on a setting in setup mode.

**You must have a valid GPS fix for any targets to be shown on the situation display.**

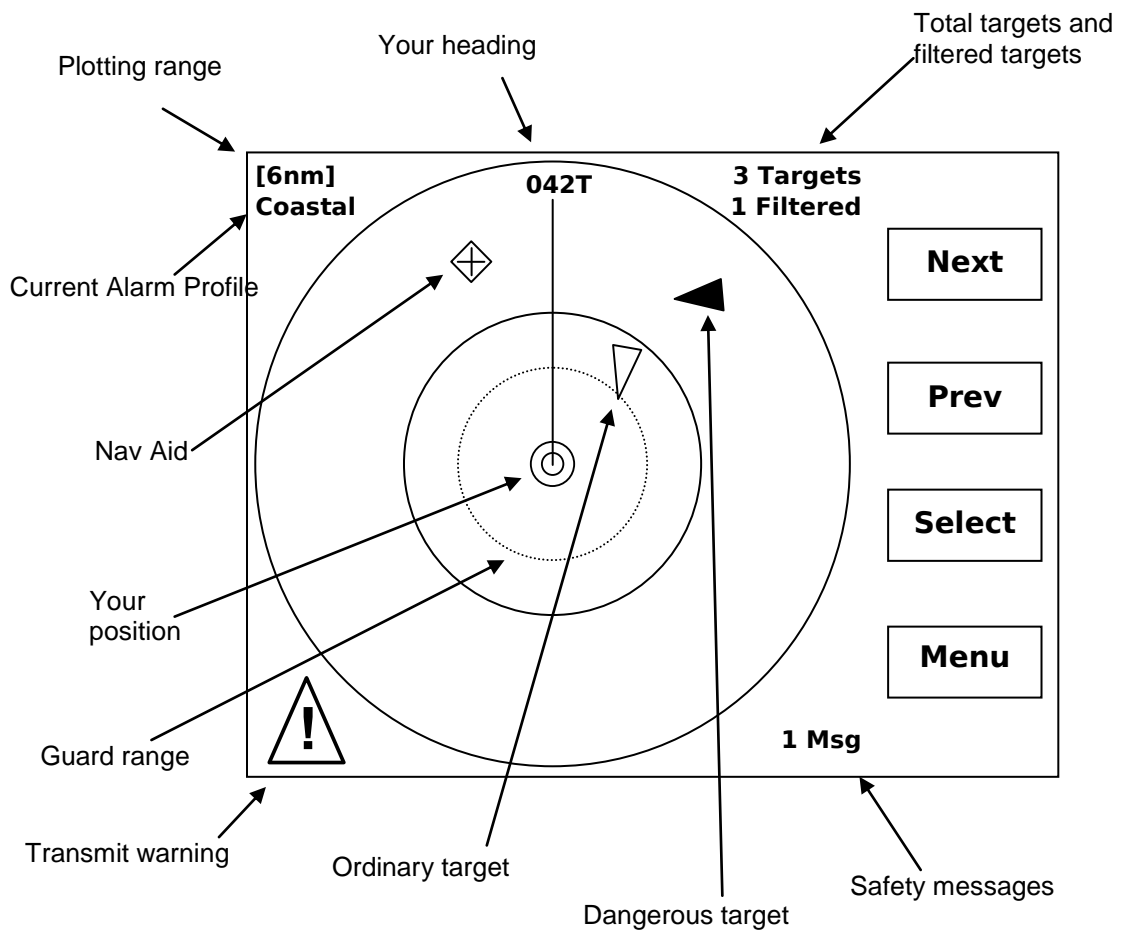

### **Range Rings**

The outer range ring corresponds to the current plotting range. The inner range ring is ½ the plotting range.

If the guard alarm is enabled an additional dotted range ring is drawn to indicate its position.

### **Plotting Range**

The plotting range may be changed by using the **Menu** button.

### **Target count**

The count of all targets includes targets which are not visible on the plotting display because they are either out of range or have not sent a position report yet. The count does not include targets which are being filtered based on the current profile settings. If targets are being filtered, the number of filtered targets is also shown.

### **Selecting a Target**

Use the **Next** and **Prev** buttons to select targets. When you select a target a small information window appears. Press the **Select** button to see the full target details.











<b>PACIFIC PEARL</b> <b>RNG: 4.27nm</b> <b>SOG: 4.3</b> <b>CPA: 0.27nm</b> <b>TCPA: 13:49</b>
---

From the situation screen you may use the following buttons:

Next	Select the next target. Targets are selected in priority order. The <b>Next</b> button starts with the highest priority target. The list of visible targets may be scrolled with the <b>Next</b> button and when no more targets are available, the current selection is cleared.
Prev	Select the previous target. The <b>Prev</b> button starts with the lowest priority target. When no more targets are available, the current selection is cleared.
Select	Display the target details screen for the currently selected target.
Menu	Brings up a menu that allows you to change the current plotting range, change your profile, enter setup, display a list of all targets in priority order or view the list of received weather or safety messages.

**Note:** Because the order of targets shown with the **Next** and **Prev** buttons depends on their priority, pressing **Next** and **Prev** may not always bring you back to the same target if their priorities have changed. This occurs more frequently when targets or your own vessel are making course changes.

## Icon Meanings

-  An ordinary target. The triangle points in the direction of the target's heading (or course if heading data is not available for the target).
-  A dangerous target. This target meets one or more of your alarm criteria.
-  An aid to navigation.
-  A dangerous aid to navigation. This target meets one or more of your alarm criteria.
-  A search and rescue transponder (AIS SART).
-  This symbol appears around a target to indicate it is the currently selected target. Press the **Select** button to view the complete target details.
-  This symbol is overlaid over a target to indicate the target is "lost". No AIS data has been received from the target within the expected interval or 10 minutes for targets that haven't reported their position. The expected interval is based on AIS-specified transmission intervals and determined by AIS class and speed.
-  A circle appears around a target that is marked as a member of your "fleet".
-  Display is oriented North-Up for this profile. Use setup to change the default orientation or the orientation associated with the current profile. If this symbol is not displayed, then the display is oriented Heading-Up.
-  Indicates your AIS data is not being transmitted. In order for your AIS data to be transmitted you must have configured the MMSI and the GPS must have a position fix. Other reasons are silent mode has been enabled or a base station has commanded your AIS transponder to enter "quiet mode". You can use the *AIS Status* screen to determine the reason.  
  
**Important:** The *AIS WatchMate* will not begin to transmit for one minute after it has been switched on. This startup time is required to determine background noise levels on the AIS frequencies. During this time, the warning symbol will be shown.
-  When used with a Vesper Marine AIS/VHF antenna splitter this symbol indicates the VHF radio is in-use and AIS transmissions are temporarily disabled.

## Main Menu

The **Menu** button on the home screen situation display allows you to select an option from the table below. Only the options which are currently applicable are displayed on the menu, so not all options will always be available.

Target List	Displays the list of targets. See the Target List section for more details. This option is only available if targets exist.
Plotting Range	Select the maximum range for the situation display. The outer range ring corresponds to this selection. The inner range ring represents ½ of

the plotting range.

- Profile** Choose a profile of alarm and filter settings. This allows you to quickly select from pre-programmed groups of settings as your situation changes. See the Profiles section for more details.
- Clear Selection** Deselects the currently selected target and removes the popup information window.
- Weather Reports** Displays the list of received meteorological and hydrographic data. This option is only available if this data has been received.
- Fleet List** Displays a list of members in your fleet. You can remove members from this list. Members are added to the list from the target details menu when you are viewing a target. This option is only available when one or more targets has been added to the fleet list. You can add a target to the fleet list using the Menu button when the target you wish to add is being displayed.
- Message List** Displays the list of received safety messages. See the Safety Message section for more details. This option is only available if one or more safety messages has been received.
- GPS Position** Displays your current GPS position, course, heading and speed. This option is only available if a valid GPS position has been received.
- GPS Status** Displays the GPS satellite receive status showing satellites in view and active satellites.
- AIS Status** Displays the AIS operational status. You may use this to determine the reason for transmit warnings and number of messages sent/received.
- Send MAYDAY** Sends a MAYDAY broadcast safety message to all AIS-equipped vessels within radio range. You can only send a broadcast safety message once per minute. Before transmission, you will be required to confirm your selection.

**Important:** AIS broadcast safety messages may not be received, recognized or acted upon in the same manner as Global Maritime Distress Safety Systems (GMDSS) messages by competent authorities or maritime first responders in your location. This feature must not be relied upon as the primary means for broadcasting a distress situation nor used in lieu of GMDSS, such as Digital Selective Calling radios. Nonetheless, AIS is an effective means to augment GMDSS and provides the added benefit of being 'seen' (on radar or other displays), in addition to being 'heard' (via broadcast safety messages) by other AIS users within radio range.

**Do not use this as your only means of communicating a MAYDAY.**

- Anchor Watch** Displays the Anchor Watch screen. Use this screen to mark your anchor location and observe your vessel in relation to your marked location. You may also enable an alarm if your vessel moves outside a preset circle around your anchor location.
- Setup** Displays the settings you can change. Also allows you to customize the alarm and filter settings for the current profile.

**Hint:** To change the settings for each profile, select the profile first and then use the Setup menu.

### Target List

The target list contains all non-filtered targets. You can scroll through the list to select a target to view in detail. By default, the target list is continuously ordered by priority. The priority of a target is based on its CPA, TCPA, range, and speed. Higher priority targets are shown at the top of the list. In setup mode you can disable this feature if you wish and targets will be displayed in the order they were first received.

Target	BRG	RNG	CPA	
PACIFIC PEARL	098M	1.5	0.1	▲
<b>LOAD RUNNER</b>	<b>081M</b>	<b>3.9</b>		
CAPTAIN RON	247M	16.1		▼
				Select
				Home

Each target shown in the target list indicates the CPA as well as the bearing and range from your vessel to the target. This facilitates visual identification. In setup mode you can change whether bearings are shown as true, magnetic, or relative to your vessel's heading.

If the target and your vessel are not converging, such as when they are moving apart, the target's CPA is blank.

If you wish, in setup mode you can configure the target list to display each target's speed over ground (SOG) rather than CPA.

When this screen is displayed, you can use the following buttons:

▲	Scroll your selection up. This button is only active if it is possible to scroll up.
▼	Scroll your selection down. This button is only active if it is possible to scroll down.
Select	Display detailed information about the selected target.
Home	Return to the situation display.

### Target Display

The target display screen is shown when you select a target from the target list or situation display. This screen contains detailed information about the target. The information displayed will vary depending on how much data has been received from the target and the type of target.

AIS data for a target is received in several types of messages and those messages may be received at different times. The interval at which a target sends messages is based on the type of message, class of target, its speed, rate of turn and other factors. As a result certain information may not be available immediately from a target. However, the AIS *WatchMate* displays available information as soon as it has been received. If you are viewing a target when new data arrives for that target, the screen is refreshed with the new data.

Until voyage information has been received for a target, its name is not available. In this case its MMSI number will be displayed instead of the name and will look like **<735023456>**. Since voyage information is received at a different interval than navigation information it may take several minutes to appear.

A target may specify its navigation status and if available it is displayed as “Motoring”, “Sailing”, “Anchored”, “Moored”, etc.

#### The navigation status may not be accurate.

An important piece of information indicates when data was last received from a target. This is shown at the bottom of the target details screen. Although bearing, range, CPA, and TCPA are constantly updated by the AIS *WatchMate* as your vessel moves, you should consider the “age” of the information received from the target in determining how accurate the displayed data may be and to assist you in refining your assessment of collision risk.

PACIFIC PEARL		
BRG <b>275</b> M	RNG <b>4.46</b> nm	Menu
CPA <b>0.09</b> nm	TCPA <b>8:45</b>	
COG <b>310</b> T	SOG <b>12.4</b> K	
HDG <b>315</b> T	ROT <b>R 5°</b> /min	CPA
IMO 3923781	MMSI 270128210	
CALL ZL3AB	CLASS A	
ETA 12/28 04:30		
DEST PAPEETE TAHITI		List
105m Tanker (Hazard: C)		
4.6m Draft, 18m Beam		
Restricted maneuverability		
S 08° 50.068	W 140° 15.014	Home
Received 00:07 ago		

If the target and your vessel will not converge, such as when they are moving away from each other, the CPA is shown as **None** and TCPA is not displayed.

When the TCPA is greater than one hour it is displayed in minutes without the seconds (eg. **123min**).

When the target display screen is shown due to an alarm condition the reason for the alarm will be blinking (eg. **RNG** for a guard alarm and **CPA** for a CPA alarm). The blinking stops when the alarm is muted or the target is no longer in an alarm condition.

If a target has an age greater than 15 minutes, it is automatically removed from the target list. You can change this number of minutes within setup in the target list group.

While the target screen is displayed, you can use the following buttons:

Menu	Allows you to disable or re-enable alarms for this target. Also allows you to add the target to your fleet. A target which is a member of your fleet is shown with a circle around its icon on the situation display.
Mute	Disable alarms for this target. This function is only active when an alarms is sounding for the target. See the section on alarms.
CPA	Display the relative position of the target at CPA. For example, this helps you determine if a target will pass ahead or behind you. See the CPA Display section. This function is only active if a target is converging and therefore has a CPA.
List	Return to the target list screen.
Home	Return to the situation display.



### CPA Graphical Display

When a target is converging and has a CPA shown, the **CPA** button is available on the target display. This button brings up a graphical plot showing the relative position of the target at the time of CPA.

The display is oriented either Heading-Up or North-Up depending on the current profile settings. If heading data is not available for your vessel, then it is oriented course-up. The heading or course may be displayed in magnetic or true degrees depending on a setting in setup mode.

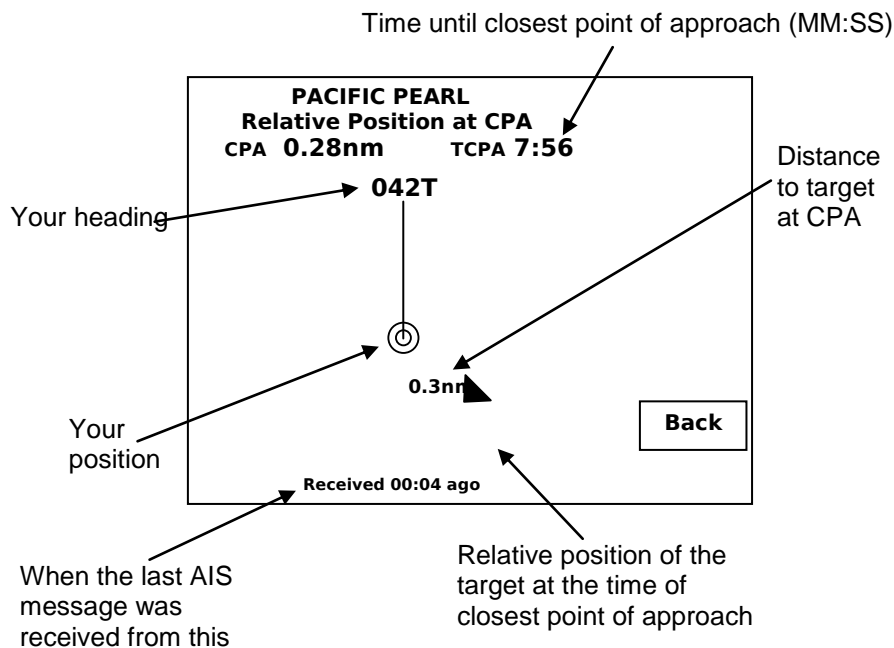

### Important notes:

1. No other targets are shown on this display. Only the current target and your vessel are displayed.
2. The plotting distance shown on the screen between your vessel and the target is always the same regardless of the actual CPA. Always use the CPA value displayed to confirm the expected distance at the time of closest point of approach.

### Safety Message List

The message list displays safety messages received from other vessels and shore stations. Safety messages are free-form text and may pertain to emergencies, port operations, hazard warnings, weather or other important information.

They may be broadcast to all AIS-equipped vessels within range or may be specifically addressed to your vessel.

You can send a pre-programmed MAYDAY safety message to all AIS-equipped vessels within range by selecting the *Send MAYDAY* option from the main menu.

When a safety message is received, the message is displayed immediately and an alert is sounded by beeping the alarm several times. If you wish, you can disable the beep in setup mode.

The list of received safety messages is available from the main menu of the situation display.

The message list shows the sender and as much of the message as can fit on each line. To view the full message, select it from the message list.

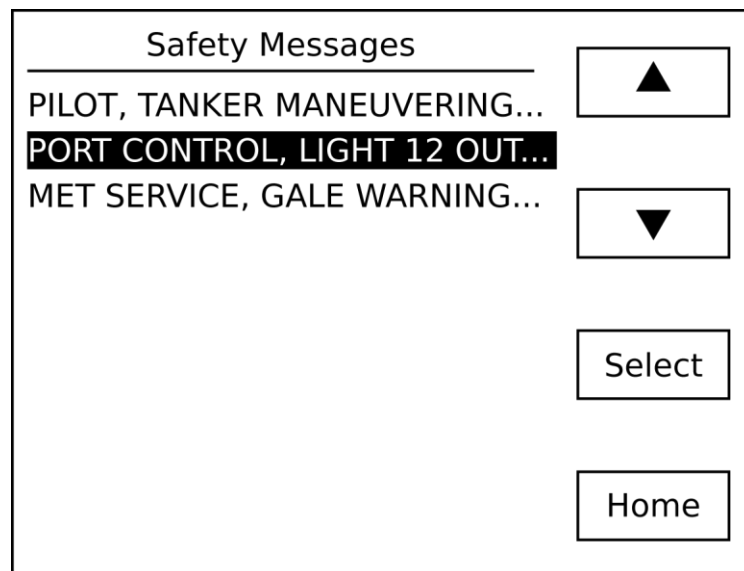

When the safety message list is displayed, you can use the following buttons:

▲	Scroll your selection up. This button is only active if it is possible to scroll up.
▼	Scroll your selection down. This button is only active if it is possible to scroll down.
Select	Display the safety message.
Home	Return to the situation display.

### **Safety Message Display**

The message display screen is shown when you select a message from the safety message list. The sender and full text of the message is shown on this screen.

When a safety message is first received, this screen is automatically shown.

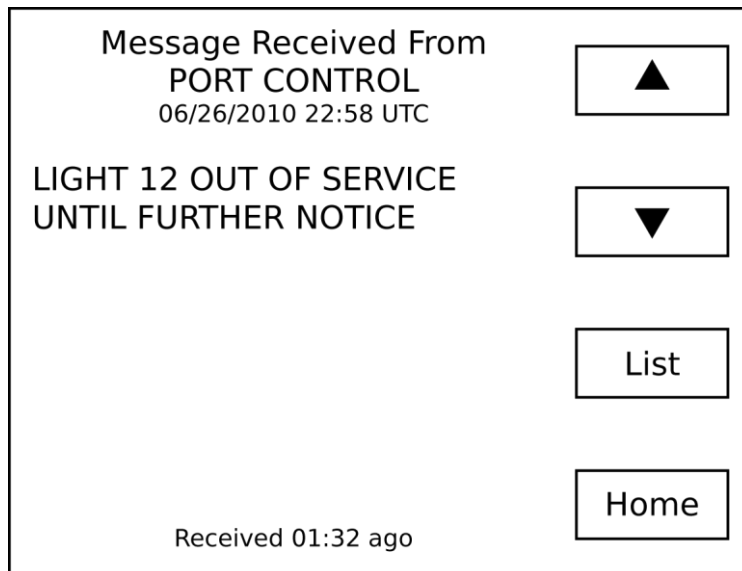

When the safety message screen is displayed, you can use the following buttons:

▲	Display the previous safety message. This button is only active if it is possible to scroll up.
▼	Display the next safety message. This button is only active if it is possible to scroll down.
List	Display the list of all safety messages.
Home	Return to the situation display.

### ***Fleet List***

If targets have been marked as being members of your fleet, they may be displayed in the fleet list. Use this list to view your fleet or remove members from your fleet. To add a vessel to the fleet list, use the **Menu** button on the target details screen.

### ***Weather Reports***

If meteorological / hydrographic messages are transmitted in your area they will be placed in a list for you to review. The list shows the latitude and longitude of each reporting station. By selecting a station from the list you can display the full details received from the station.

### ***GPS Position Display***

You may display your current GPS position, course, heading (if available) and speed over ground.

### ***GPS Status Display***

Use this display to view the signal strength of each GPS satellite in view. All satellites in view are shown and those that are being actively used are indicated with a dark bar. In addition, UTC time, computed accuracy (HDOP) and 2D/3D status is shown.

## AIS Status Display

This screen displays information about your AIS transponder's status. In the box at the top of the screen the tick marks indicate the primary operational state. If any items require attention they will be indicated by this symbol:



If this symbol is shown, the AIS WatchMate is not transmitting your vessel's AIS data.

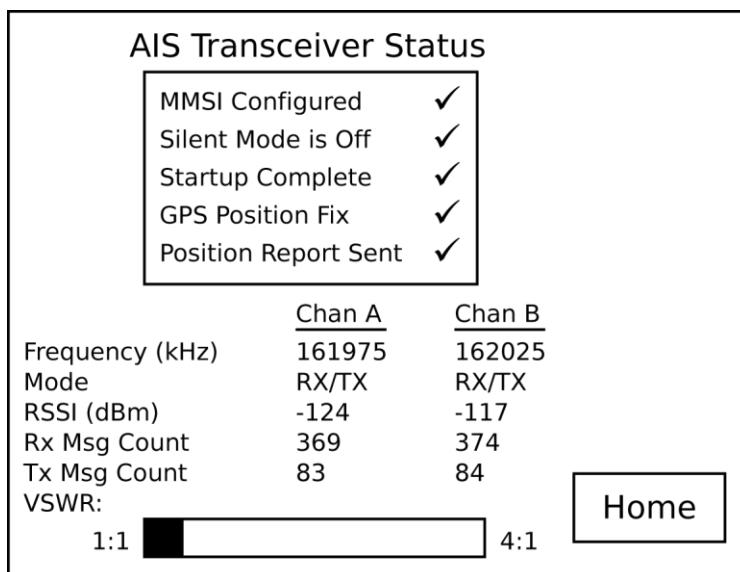

A description of each item is shown below.

MMSI Configured	You must configure your AIS WatchMate with a valid MMSI before transmission can occur. See the <i>Configuration</i> section.
Silent Mode is Off	One of these conditions: <ol style="list-style-type: none"> <li>1. You have enabled silent mode. See the Silent Mode setup option under AIS Transceiver Setup.</li> <li>2. Your transponder has been commanded by a base station to enter "quiet mode". You cannot override this command. Normal transmissions will resume automatically at a later time.</li> </ol>
Startup Complete	There is a one minute startup time whenever you switch on the AIS WatchMate. During this time, background noise levels are determined.
GPS Position Fix	Your AIS WatchMate must have a valid GPS fix in order to transmit. See the <i>GPS Status</i> screen to determine satellite signal strengths. If you are unable to achieve a GPS fix due to low satellite strength, consider using an optional accessory external antenna or moving the unit or antenna. Always place GPS antennas as far away as possible from other antennas, such as radar antennas.
Position Report Sent	Indicates that the last scheduled position report was sent. It is normal to occasionally miss a position report when operating in busy areas.

Frequency	The radio frequency assigned to each channel. You cannot change this value.
Mode	The operating mode for each each channel. You cannot change this value.
RSSI	The background noise level for each channel. This is for informational purposes.
Rx Msg Count	The number of AIS messages that have been successfully received on each channel.
Tx Msg Count	The number of AIS messages that have been successfully transmitted on each channel.
VSWR	<p>A relative measure of the efficiency of your antenna system. Lower numbers indicate a better match. Values greater than 3:1 may cause VSWR errors to be displayed.</p> <p>If you have a high VSWR it indicates a poor antenna match or a problem with a cable or connector. Check that your antenna is designed for operation at 162 Mhz (the high end of the marine VHF band). Check that all connections are properly made and tight and check for an open or short circuit on all cables. Finally, the placement of the antenna may have an effect. For example, do not mount the antenna close to other antennas or metal structures, such as a mast.</p> <p>The VSWR measurement is updated on every transmission. Prior to the first transmission, the message "Waiting for TX..." will be displayed.</p> <p> This warning symbol is displayed next to the VSWR scale when the VSWR is too high and you must find the source of the problem in the antenna system.</p> <p><b>Note:</b> Not all revisions of the AIS <i>WatchMate</i> 850 are able to display the VSWR or the warning symbol.</p>

### Using the Anchor Watch

The anchor watch may be used to sound the alarm if your vessel moves outside a preset circle. To use the anchor watch, follow these steps:

1. Prior to anchoring, select "Anchor Watch" from the main menu.
2. Adjust the size of the preset circle by using the **Dist** button. This button determines the alarm distance from your anchor (or radius) of the circle. The distance may be changed at any time.
3. Press the **Set** button to mark your anchor location as you drop your anchor and when it hits the bottom. This automatically enables the alarm at your preset distance.

When the Anchor Watch screen is displayed, the bearing from your vessel to the marked anchor location is shown. It is shown in either Magnetic or True, depending on your Preference Settings which can be adjusted in setup mode.

The distance between your vessel and the marked anchor location is also displayed. This distance may be in feet or meters depending on your Preference Settings.

The position of your vessel periodically within the last 24 hours is shown as a dot. These positions are useful to show your vessel swinging on its anchor. They are automatically removed when you reset your anchor position or shut off your AIS WatchMate.

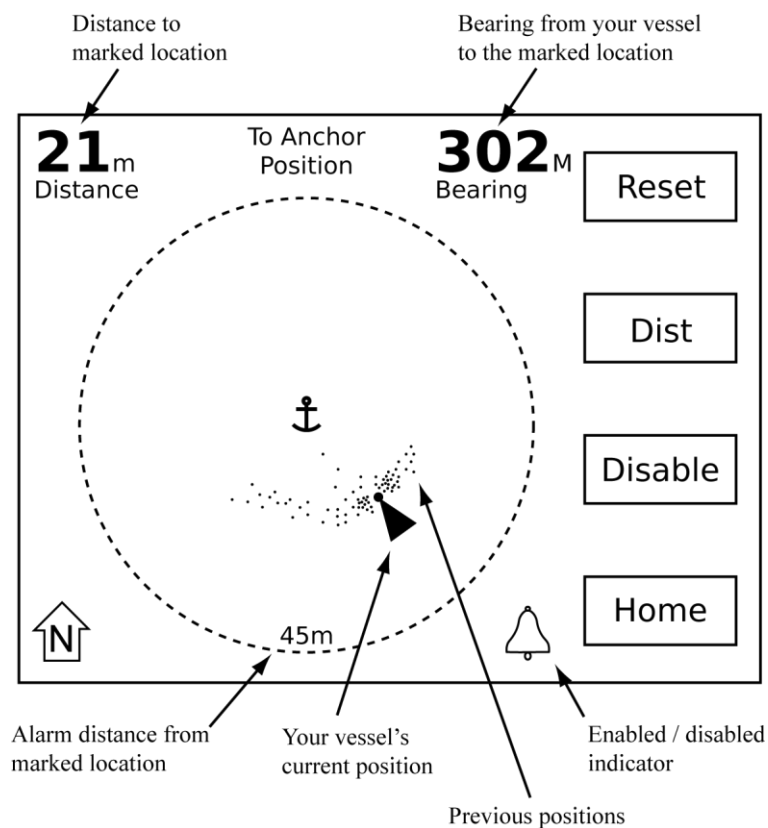

Use the following buttons from the Anchor Watch screen:

Reset	Reset the anchor location to your current position.
Dist	Adjust the alarm distance (radius of the circle).
Enable Disable	Turn the alarm on or off.
Home	Return to the situation display. <b>Note:</b> If the alarm is enabled, it will remain active.

### ***Use of Heading Data***

If heading data is available, your vessel is shown oriented by its heading. If heading data is not available, your vessel is shown oriented by its course and it is likely it will not correspond accurately with reality. It is also normal for the orientation of your vessel to fluctuate or point north in this circumstance.

### ***Effect of GPS Antenna Reference Location***

The Anchor Watch determines the position of the bow of your vessel and uses it when marking your anchor location and also when plotting your current vessel position. This increases accuracy as your vessels swings around its anchor. However, this can only be done if a heading sensor is connected to your AIS *WatchMate*. It also requires that your vessel's GPS antenna reference location (A, B, C, D) is configured using the AIS Transceiver Setup screen.

If a heading sensor is not connected or your GPS antenna reference location is not configured, then the Anchor Watch uses the position of your GPS antenna for both marking the anchor location and vessel positions.

### ***Auto Clear***

If the Anchor Watch alarm is not enabled and your vessel has moved a significant distance from its previously marked anchor location, the Anchor Watch automatically clears the previously marked location. This allows you to more easily set a new anchor watch using the procedure above each time you move to another location.



### ***Icon Meanings Within Anchor Watch***



Your vessel. The reference position of your GPS antenna is not known or heading data is not available.



Your vessel. The dot at the bow indicates that your position is referenced to the bow of your vessel.



The alarm is enabled and will sound if your vessel moves outside the circle. Adjust the distance from your marked anchor location by using the “Dist” button.

**Note:** To prevent nuisance alarms, the alarm does not sound immediately when your vessel moves outside the circle. It may take several seconds for the Anchor Watch to confirm your vessel's position is outside the circle before sounding the alarm.



The alarm is disabled.



The Anchor Watch screen is always displayed North-Up. This cannot be changed.

### ***Displaying Information About your AIS WatchMate***

You can display the following information by selecting *About your AIS WatchMate* from the display settings menu.

This information is provided for reference and technical support purposes.

About your AIS WatchMate

Model	WMX850
Revision	B
S/N	XXXXXXXX
Firmware	5.04.1501
Calibrated	Yes
Input power	12-24 VDC 1A max 3W nom
Compass safe	0.6m

Hardware Features:

GPS	✓
AIS Receiver	✓
AIS Transmitter	✓

Back

### Placing Individual DSC Calls

If you have a compatible DSC radio, you can use your AIS WatchMate to place an individual DSC call to another vessel without having to enter the other vessel's MMSI number manually into your VHF radio.

To use this feature, you must connect a compatible VHF radio's NMEA-input to the AIS WatchMate NMEA-output. You must also select "NMEA only (4800)" for the NMEA output port setting on your AIS WatchMate. Once this has been done, an additional menu option will appear in the menu (top button) on the target display screen. Selecting the "DSC Call" menu option brings up a small window that allows you to select the working channel.

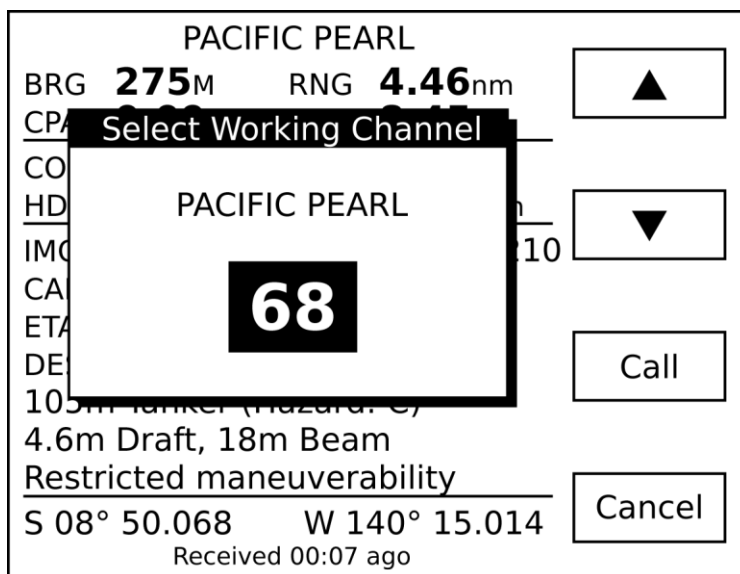

Use the arrow buttons to scroll up/down to the desired channel. The last used working channel is remembered and becomes the default for subsequent calls.

Use the "Call" button to place the call or "Cancel" to return to the target display without calling.

**NOTE:** This feature requires a compatible VHF radio that accepts the NMEA-0183 DSC sentence. This will work with certain Icom radios and may work with other brands. Some radios may require a firmware upgrade. Vesper Marine publishes a list of compatible radios on its website at [www.vespermarine.com](http://www.vespermarine.com).

We are interested in learning which other VHF radios support this capability. If you have tried this feature and found it to work, please tell us by contacting [support@vespermarine.com](mailto:support@vespermarine.com) or visit the support section of our website [www.vespermarine.com](http://www.vespermarine.com).

If your VHF radio is not compatible, or is not properly connected, then using the "DSC Call" option will have no effect.

**IMPORTANT NOTE:** Test this feature with your specific VHF radio to ensure it is working properly before relying on it.

## Target Filters

There are several filters which allow you to control which targets are included in the target list and may be displayed. These give you the ability to limit the target list and are most useful when operating in areas with large amounts of vessels. Any filter can be turned off. If all filters are turned off, then all possible targets are included in the target list and all targets may trigger alarms.

**When a target is filtered, it is not shown in the target list. No alarms are triggered for filtered targets.**

Target range filter	<p>Specifies the maximum range (distance in nautical miles) for targets. Any targets farther away than this distance will not be included in the target list and will not trigger alarms.</p> <p>This allows you to only view and trigger alarms for targets that are “nearby” and filters out targets that are farther away.</p> <p><b>It is not recommended to set this value too low since it may filter out all targets and alarms.</b></p>
Target speed filter	<p>Specifies the minimum speed (in knots) a target must be moving. Any targets moving slower than this speed will not be included in the target list and will not trigger any alarms.</p> <p>This allows you to eliminate from the target list and prevent alarms for targets which are stationary or moving very slowly. It is most useful when there are large numbers of anchored or moored vessels in your operating area.</p> <p><b>It is not recommended to set this value too high since it may filter out all targets and alarms.</b></p>
Target CPA filter	<p>Specifies the maximum CPA allowed for a target to be visible. All targets with a CPA greater than this value will be filtered and not shown. You can also select “Non-Converging” which causes all targets which are not converging (they have no CPA) to be filtered.</p> <p>This allows you to eliminate from the target list all targets which are either moving away from you or will pass at a safe distance. It is most useful when there are many moving targets.</p>
Target TCPA filter	<p>Specifies the maximum TCPA allowed for a target to be visible. All targets with a TCPA greater than this value will be filtered and not shown.</p> <p>This allows you to eliminate from the target list all targets which are not going to be nearby soon. It is most useful when there are many moving targets.</p>

## Target Alarms

There are two types of target alarms provided by the AIS *WatchMate*. They are called Guard Alarm and CPA Alarm. Each alarm applies independently to each target. This means that

alarms may be silenced for some targets but will still remain active for other targets.

When an alarm is sounded, the display immediately shows the target that has triggered the alarm. Pressing the **Mute** button silences the alarm and all subsequent alarms for that target only. Other targets may still trigger alarms. The idea is that you have acknowledged the target and are now aware of its presence and/or collision potential. The *AIS WatchMate* will continue to monitor and update the display for that target, but **unless you turn the alarm back on for that target it will not cause any other alarms.**

To turn the alarm back on for a target, use the **Enable Alarms** from the target menu. The display briefly shows whether alarms are muted or enabled for each target whenever the **Enable** or **Disable Alarms** menu item is selected.

If more than one target is simultaneously triggering alarms, then the highest priority target is shown first. Once you have pressed the **Mute** button for that target, the next highest priority target is immediately shown and the alarm sounds again. When you press the **Mute** button for the last (or only) target with an alarm triggered, the display remains showing that target.

When an alarm is triggered for a target, the target is automatically displayed and the reason for the alarm is blinking (eg. **RNG** for a guard alarm and **CPA** for a CPA alarm). The blinking stops when the alarm is muted or the target is no longer triggering an alarm.

### **Guard Alarm**

The simplest type of target alarm is the guard alarm. It is triggered whenever a target is within range of the alarm setting. It works similar to a radar guard alarm. You select the range for the alarm and if any vessel is currently within that range, in any direction around you, the alarm is triggered.

When a guard range is selected, a guard alarm is only triggered for a target when it is currently within the guard range and is not based on whether the target will enter the guard range at some time in the future.

You can also select to have all targets trigger an alarm regardless of their range by setting the guard alarm to "ALL" rather than a specific range. When this setting is enabled the alarm will sound when data is first received for each target. This alarm setting is most useful offshore or anywhere targets are expected to be encountered infrequently. It is used to notify the user that an AIS target exists "out there" even if the target poses no collision risk.

When a guard alarm is triggered the target is immediately displayed. Press the **Mute** button to silence the alarm. No further alarms will be triggered for this target. However, if you still wish to have a subsequent CPA alarm for this target, use the **Enable Alarms** menu item to re-enable alarms for the target. When you re-enable alarms, the guard alarm is not sounded again. Only subsequent CPA alarms will be re-enabled. The reason is you have been alerted to the target's presence and acknowledged it but have now indicated you also would like to have an alarm triggered if a collision risk exists.

**Important note: Guard alarms will not be triggered if GPS information is unavailable for your vessel.** Guard alarms which specify a range require GPS data for your vessel. These alarms will not be triggered if GPS data is not available. However, if you set the guard alarm to "ALL", then the alarm will sound regardless of whether GPS data is available or not. You can use this feature if you have not connected the *AIS WatchMate* to a GPS but wish to be alerted when targets are present. **This is the only alarm setting that will work when GPS data for your vessel is not available.**

### **CPA Alarm**

A CPA alarm is triggered when a target meets the criteria you have established. When a CPA alarm occurs, the target that caused the alarm is displayed. Press the **Mute** button to silence the alarm. No further alarms will be triggered for this target. However, if you wish to

re-enable CPA alarms for this target again, use the **Enable Alarms** menu item. Naturally, if the target is still within the parameters established for triggering a CPA alarm, the alarm will immediately sound again for that target!

There are several settings that control when a target triggers a CPA alarm:

CPA alarm	<p>The distance (in nautical miles) which causes a CPA alarm to be triggered. If a target has a CPA of this value, or less, an alarm will be triggered for that target unless the alarm is suppressed by any of the other settings described below.</p> <p>This allows you to generate an alarm for any target that is predicted to come “too close”.</p>
CPA alarm – time	<p>The time (in minutes) of when the CPA will occur. If the CPA time is greater than this value then no CPA alarm will be triggered for this target.</p> <p>This allows you to suppress alarms for targets which are predicted to come close but not for a long period of time.</p>
CPA alarm – target speed	<p>The speed (in knots) which the target must be moving in order to trigger a CPA alarm. If the target is moving at less than this speed then no CPA alarm will be triggered for this target.</p> <p>This allows you to suppress alarms for targets which are either stationary (anchored or moored) or are moving very slowly (drifting, fishing, etc.).</p>
CPA alarm – your speed	<p>The speed (in knots) that your own vessel must be moving in order to allow CPA alarms. If your vessel is moving at less than this speed then no CPA alarms will be triggered for any targets.</p> <p>This allows you to suppress alarms when your vessel is anchored, moored, drifting, fishing, etc. It can be used to turn off alarms automatically when you stop or slow down and eliminates the need to turn the AIS <i>WatchMate</i> off or select the Anchored profile.</p>

**Important note: CPA alarms are not triggered if GPS information is not available for your vessel.**

## **Profiles**

To organize the filter and alarm settings there are four “profiles”. These allow you to quickly switch between various settings when your situation changes. This is done by selecting the active profile from the main menu on the situation display. Each profile is provided with a default value for its settings, but you can change these values and they will remain at your selected settings until you change them again, even after you turn the unit off. You can switch profiles or make changes to the settings associated with a profile at any time.

To change the settings associated with a profile, you must select the profile first and then enter setup mode.

**Harbor**

This profile is intended to be used when navigating within a harbor where frequent shipping and AIS traffic is expected.

**Coastal**

This profile is intended to be used when navigating along a coast or shore where occasional shipping and AIS traffic is usually encountered.

**Offshore**

This profile is intended to be used when navigating in open ocean situations where little shipping and AIS traffic is expected.

**Anchor**

This profile is intended to be used when anchored or moored and when you only want to view AIS information from other vessels. By default, no alarms are enabled in this profile.

## Setup Mode

Setup mode is entered by selecting Setup from the main menu on the situation display. In setup mode the list of available setting groups are displayed. Scroll through the list and select the setting group you wish to change. You may then follow the same procedure to select the specific setting you wish to change and a pop up box is displayed with the available options for that setting.

**Note:** Filter and alarm settings are associated with a profile and only the settings in the currently active profile may be changed. If you wish to change the settings for a different profile, you must select the profile before entering setup mode.

While the settings screen is displayed, you can use the following buttons:

▲	Highlight the previous setting. This button is only active if it is possible to scroll up.
▼	Highlight the next setting. This button is only active if it is possible to scroll down.
Select	Change the highlighted setting.
Home	Save any changes and return to the situation display.

Any changes you make to settings are stored permanently until you change them again, even if you turn off the power.

## Target List Settings

Data display in target list	Choose whether to display each target's SOG or CPA in the target list.  The default is to display CPA in the target list.  However, if you are not using the target speed filter you may find it useful to display the target's speed instead.
Sort targets by priority	Displays targets sorted by their priority. A target's priority is based on its CPA, time until CPA (TCPA), range, and speed. You can choose to disable this setting and targets will be displayed in the order in which data was first received from a target.
Inactive target display time	Selects how many minutes to display a target that is no longer being received.



## Alarm Settings

Lost position alert	<p>Choose whether to enable or disable an alert which sounds if your vessel's position becomes unavailable for more than 15 seconds.</p> <p>This alert sounds the alarm with a single short beep and may indicate a problem with GPS reception, your GPS device, or wiring.</p> <p>When position information is not available for your vessel, computed information about each target (range, bearing, CPA, TCPA) are not displayed.</p> <p>In addition, if position information is not available a message is shown on the situation display, target list, and target display.</p> <p><b>Note: If your vessel's position is not available then alarms will not be triggered.</b></p>
Safety message handling	<p>Choose whether to enable or disable an alert which sounds when a safety message is first received.</p> <p>This alert sounds the alarm with three short beeps.</p> <p>If the same message is received again it does not sound the alarm.</p>
NMEA device alerts	<p>Choose whether to display NMEA device alerts (sentence ALR). When this setting is enabled, each alert sounds the alarm with a single short beep and is displayed in a message box. When a NMEA device alert message is displayed, press the <b>Confirm</b> or <b>Ignore</b> button. See the section on NMEA Device Alerts in this document.</p>
Alarm mode	<p>Choosing Internal-only will only sound the internal alarm. External-only requires an external alarm, buzzer or indicator be connected. You can also select to have both sound simultaneously.</p> <p><b>Caution:</b> Audible alarms will not occur if you select External-only and an external alarm is not fitted.</p>
Test the alarm	<p>Allows you to test the internal or external alarm to ensure it is working properly.</p>

## Navigation Settings

Course and heading mode	<p>Select how to display course and heading data for targets. This also affects how your vessel's heading is shown on the situation display. You may choose between True or Magnetic.</p>
Bearing to target mode	<p>Select how to display bearings to targets. The default is magnetic and is recommended for easy visual identification of targets using a compass and/or binoculars. However, if you prefer you may select true or relative bearings.</p> <p>Relative bearings show the target's bearing relative to your own vessel's heading (eg. 000R is directly ahead of you, 180R is directly behind, 270R is off your port beam, and 090R is off your starboard beam).</p> <p>To display relative bearings, heading data for your vessel should be</p>

	<p>available. This data may be output from a heading sensor or autopilot. Consult the manual for these devices. The AIS WatchMate accepts NMEA 0183 sentences HDG, HDT, or HDM for heading data.</p> <p><b>Note:</b> If heading data is not available then relative bearings will be shown relative to your course rather than your heading.</p>
Default display orientation	Select the orientation (Heading-Up or North-Up) you wish to use by default. This orientation is used if a profile doesn't override this setting. This allows you to indicate that you wish all profiles to use a particular orientation except one that specifies otherwise. For example, always use Heading-Up except when anchored when you want to use North-Up.
GPS Smoothing	The setting enables a GPS smoothing function which enhances position and course stability. This setting is suitable for most situations. Disabling GPS smoothing causes the GPS position, course and speed to be more dynamic and respond more quickly to changes but introduces a wider amount of fluctuation.
GPS SBAS (WAAS, EGNOS)	Use this setting to enable or disable GPS differential corrections received from Satellite Based Augmentation Systems such as WAAS, EGNOS, MSAS and GAGAN.
Simulation mode	Use this setting to start or stop a simulation of GPS and AIS targets for demonstration purposes. When the simulation is running, actual GPS positions and targets are not displayed.

### Display Settings

Brightness	Adjusts the brightness of the display and buttons. You can also adjust the brightness by momentarily pressing the power button.
Contrast	Adjusts the display contrast.
Turn display off when idle	<p>Select the number of minutes after which the display is turned off. If the display is off and a target or message is received the display is automatically turned back on.</p> <p>The display is only turned off when there are no targets and no messages.</p> <p>To turn the display back on manually, press any button.</p> <p>Select “<b>Disable</b>” to leave the display on at all times.</p> <p>When enabled, this feature reduces power consumption when there are no targets or messages to display.</p>
About your AIS WatchMate	Displays information containing your product model, serial number, version and other data. See the section <i>Displaying Information About Your AIS WatchMate</i> for more details.

### Preference Settings

Language	Select the language you wish to use.
Date format	Select between MM/DD and DD/MM. This setting determines how a target's ETA is displayed.

Metric or imperial	Select the units (metres or feet) to use for displaying target dimensions.
Button sound	Enable or disable a brief sound whenever a button is pressed.

### ***AIS Transceiver***

Silent Mode	Enable or disable the AIS transmitter. This feature may be used in situations where you do not wish to transmit your vessel data.
Your vessel AIS details	Configure your vessel details for transmission to other vessels via AIS. The <i>AIS WatchMate</i> will not transmit until you have configured your vessel details. See the <i>Configuration</i> section for more details.

### ***I/O Port Settings***

NMEA input	Select the type of device connected to supply input on this port. Choose from NMEA 4800 baud or NMEA 38400 baud.
NMEA output	Select the type of data to output on this port. Choose from NMEA-only at 4800 baud, AIS-only and NMEA+AIS at 38400 baud.  <b>Note:</b> All data input on the NMEA input port is “repeated” on the NMEA output port, regardless of this setting. This allows you to use the <i>AIS WatchMate</i> to combine NMEA instrument data and the internally-generated AIS and GPS data into a single combined output stream.  <b>Note:</b> These settings apply only to the NMEA input and output ports. They do not apply to the USB port. The USB port always operates at 38400 baud and outputs all available data.

### ***Additional Settings***

Reset all settings	Resets all settings to the original factory values. Any settings you have changed will be reset and you will lose any changes you have made.  When you select this setting a warning is displayed. To continue and reset all settings, choose “ <b>Yes</b> ” to “Are you sure?” and press “ <b>OK</b> ”.  When you answer “ <b>Yes</b> ” or “ <b>No</b> ”, a message is briefly displayed confirming your choice.
--------------------	---

### ***Settings Associated with Each Profile***

The following settings are associated with a profile selection. Each profile (Harbor, Coastal, Offshore, and Anchor) has it's own value for each of these settings. The setup screens display the settings associated with the currently active profile. The name of the current profile is shown on the top line of the screen. Any changes to these settings affect the current profile only.

**Hint:** To change the settings for a profile you must activate the profile first. Do this from the main menu on the situation display before entering setup mode.

Display orientation	<p>Choose the orientation of the display when this profile is activated. The orientation can be Heading-Up, North-Up or Use Default. If you select Use Default then the default display orientation (determined in the Display Settings Group) will be used. This allows you to override the default for one or more profiles, for example setting the default to Heading-Up but overriding it to be North-Up when anchored.</p>
Target speed filter	<p>This specifies the minimum SOG (in knots) that a target must be moving to be included in the target list. Targets moving slower than this speed will be filtered from the target list and will not appear.</p> <p>Use this filter to eliminate slow or stationary targets from the target list. Alarms are not triggered for filtered targets.</p> <p>The total count of filtered targets is displayed on the situation display.</p> <p>Selecting “<b>OFF</b>” disables the target speed filter.</p> <p>If this setting is higher than the “CPA alarm - Target Speed” setting a warning is displayed to indicate you may be filtering more targets than you intend.</p> <p><b>It is not recommended to set this value too high since it may filter out all targets and alarms.</b></p>
Target range filter	<p>This specifies the maximum range (distance in nautical miles) for a target to be included in the target list. Targets farther away will be filtered from the target list and will not appear.</p> <p>Use this filter to eliminate distant targets from the target list. Alarms are not triggered for filtered targets.</p> <p>The total count of filtered targets is displayed on the situation display.</p> <p>Selecting “<b>OFF</b>” disables the target range filter.</p> <p><b>It is not recommended to set this value too low since it may filter out all targets and alarms.</b></p>

Target CPA filter	<p>This specifies the maximum CPA value a target can have and still be displayed. Any targets with a CPA greater than this value will be filtered.</p> <p>Use this filter to eliminate targets which will pass at a safe distance. Alarms are not triggered for filtered targets.</p> <p>The total count of filtered targets is displayed on the situation display.</p> <p>Selecting “<b>OFF</b>” disables the target CPA filter.</p> <p>Selecting “<b>All Non-converging</b>” indicates that all targets that do not have a CPA (meaning they are not on a converging course) will be filtered.</p> <p>If this setting is lower than the “CPA alarm - Target Speed” setting a warning is displayed to indicate you may be filtering more targets than you intend.</p>
Target TCPA filter	<p>This specifies the maximum TCPA value a target can have and still be displayed. Any targets with a TCPA greater than this value will be filtered.</p> <p>Use this filter to eliminate targets which will not be nearby soon. Alarms are not triggered for filtered targets.</p> <p>The total count of filtered targets is displayed on the situation display.</p> <p>Selecting “<b>OFF</b>” disables the target TCPA filter.</p> <p>If this setting is lower than the “CPA alarm - Time” setting a warning is displayed to indicate you may be filtering more targets than you intend.</p>
Guard alarm range	<p>This specifies a range in nautical miles. Targets within this range will trigger a guard alarm regardless of whether a collision risk exists.</p> <p>Guard alarms are most useful when operating where few targets are expected to be encountered and you wish to be notified there is “somebody out there”.</p> <p>Selecting “<b>OFF</b>” disables the guard alarm.</p> <p>Selecting “<b>ALL</b>” indicates that all targets regardless of their range will trigger the guard alarm.</p> <p><b>Important note: “ALL” is the only alarm setting that operates without GPS input.</b></p>
CPA alarm	<p>Triggers a CPA alarm for any target which will come this distance or closer to your vessel (in nautical miles).</p> <p>An alarm will not be triggered if the target doesn't also meet the specifications of the other CPA alarm settings described below.</p> <p>Selecting “<b>OFF</b>” disables the CPA alarm.</p>

CPA alarm - Time	<p>This value specifies the maximum amount of time (in minutes) that a target's CPA must occur for it to trigger an alarm. If a target has a CPA which is "too close" but the TCPA is greater than this value, no alarm will be triggered.</p> <p>This allows you to indicate that you only want alarms for targets which pose a risk of collision in the "near future".</p> <p>Selecting "<b>OFF</b>" allows a CPA alarm to be triggered regardless of the time until CPA if it also meets the specifications of the other CPA alarm settings.</p> <p>This setting is only available if the "CPA alarm" setting is not set to "<b>OFF</b>".</p>
CPA alarm - Target Speed	<p>This value specifies the minimum SOG (in knots) that a target must be moving for it to trigger a CPA alarm. If a target meets the other specifications for a CPA alarm but is not moving at least this fast, no alarm will be triggered.</p> <p>This setting allows you to indicate that you don't want alarms for stationary or slow moving targets.</p> <p>Selecting "<b>OFF</b>" allows a CPA alarm to be triggered regardless of the target's speed if it also meets the specifications of the other settings.</p> <p>If this setting is lower than the "Target speed filter" setting a warning is displayed to indicate you may be filtering more targets than you intend.</p> <p>This setting is only available if the "CPA alarm" setting is not set to "<b>OFF</b>".</p>
CPA alarm - Your speed	<p>This value specifies the minimum SOG (in knots) that your vessel must be moving for a CPA alarm to be triggered by other vessels. If a target meets the other specifications for a CPA alarm but your vessel is not moving at least this fast, no alarm will be triggered.</p> <p>This setting allows you to indicate that you don't want alarms when you are stationary or moving slowly.</p> <p>Selecting "<b>OFF</b>" allows a CPA alarm to be triggered regardless of the target's speed if it also meets the specifications of the other settings.</p> <p>This setting is only available if the "CPA alarm" setting is not set to "<b>OFF</b>".</p>

## ***Built-in Integrity Test (BIIT)***

The AIS WatchMate continuously monitors its transceiver performance. If it detects an error condition you will be notified with a message box and the alarm will beep briefly. For certain messages you are able to press the Confirm button to acknowledge the situation and prevent the message from reappearing. However, this is not possible with all messages and some will reappear whenever the error condition is detected. An example message box is shown below.

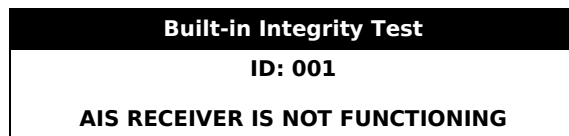

Some possible error conditions are:

AIS RECEIVER CH n: SYNTHESIZER LOST LOCK

AIS RECEIVER IS NOT FUNCTIONING

AIS TRANSMITTER ERROR: reason

VSWR LEVEL: CHECK ANTENNA CONNECTIONS

ERROR DETECTED WITH INTERNAL GPS

## **Device Alerts**

The AIS *WatchMate* will display device alerts (sentence \$xxALR) received from other instruments. These alerts may indicate operational status or problems. When a device alert arrives, the message associated with it is displayed and you are given the opportunity to send a confirmation back to the device that generated the alert. This tells the device that you have acknowledged the situation. The specific types of alerts and messages are determined by the attached devices. Please consult the manuals for the other devices for details about each message.

When a message arrives, it is displayed automatically and the alarm is beeped briefly to notify you. Press the **Confirm** or **Ignore** button to dismiss the message. If you press the confirm button, an acknowledgment message (sentence \$xxACK) is sent back to the device containing the message ID.

An example message (the message content is supplied by the other device and will vary from device to device):

<b>NMEA Device Alert</b>
<b>ID: 003</b>
<b>HDG: HEADING SENSOR INACTIVE</b>



## Troubleshooting

Problem	Solutions
Display shuts off	Check to see if the “Turn display off when idle” setting is enabled.
Won't shut off when I press the power button	Press and hold the power button for 2 seconds.
CPA alarm doesn't sound	<ol style="list-style-type: none"> <li>1. Check the profile you have selected by looking on the situation display or choosing the Profile item from the main menu on the situation display.</li> <li>2. Use setup to verify the CPA alarm parameters for the current profile.</li> <li>3. Check “CPA alarm” setting to make sure it is enabled and set to a value greater than the range of the target in question.</li> <li>4. Ensure the “CPA alarm - Time” setting isn't set too low.</li> <li>5. Check the “CPA alarm – Target speed” and “CPA alarm – Your speed” settings.</li> </ol>
Alarms sounds for every target	Use setup to verify the “Guard alarm range” setting for the current profile. If this setting is “ALL” then every target will trigger an alarm.
“CHECK ANTENNA CONNECTIONS” error appears	<p>Verify that your antenna, cable, and connections are good. Most problems are the result of an open or shorted connector. Use a meter to verify them. Check with your antenna manufacturer to determine if your antenna should meter open or shorted.</p> <p>Ensure your VHF antenna is mounted well away from other antennas (3m is best) and away from parallel metal structures like a mast or rigging.</p> <p>Although a marine VHF antenna may usually be used, AIS frequencies are at the high end of the marine VHF band. As a result, some antennas may have high VSWR levels when used by AIS.</p> <p>Note: Some versions of the firmware automatically place the transponder in Silent Mode to help prevent you from causing damage to your unit or your antenna system. Once you have found the cause of the problem, you may take the transponder out of Silent Mode using the “AIS Transceiver” setup option.</p> <p><b>CAUTION: Never operate this device unless it is connected to a suitable VHF antenna or Vesper Marine AIS/VHF antenna splitter.</b></p>

### ***Examining Received NMEA Data***

As a troubleshooting aid it is possible to have the *AIS WatchMate* display the raw sentence data received on its NMEA input port. This can help you to resolve wiring and other installation problems. When using this mode, normal operation is not performed. Only the raw data display is done.

To view the raw sentence data received on the NMEA port, press and hold the 2nd button from the top while turning the unit on by pressing the power button. Once the unit has come on and displayed the message "Data Received from NMEA Port", you can release the top button.

All data received on the port will be displayed as it arrives. When the display fills it will be erased and data will again be displayed from the top. You can freeze the display by pressing and holding any button. To resume the display, release the button.

To return to normal operation, turn the unit off and back on again.

## **Warranty - North America**

The AIS *WatchMate* is warranted, when properly installed and used, to be free from defects in materials or workmanship for two years from the date the product was purchased by the first retail customer. This warranty applies to the original retail purchaser only and is not transferable. Within this period, Vesper Marine will, at its sole option, repair or replace any components which fail in normal use. Repairs or replacement will be made at no charge for parts or labor, provided that the customer shall be responsible for any transportation costs. This warranty does not cover failures due to abuse, misuse, accident, improper installation, unauthorized alterations or repairs, shipping damage, wear and tear, or corrosion.

This warranty is void if the product's external housing has been opened, the serial number or other labels have been removed or altered, the specified input voltage has been exceeded, or the external alarm maximum switched current has been exceeded. This warranty is void if the product has been operated with an incompatible GPS antenna or without a suitable VHF antenna.

Vesper Marine retains the exclusive right to replace the unit at its sole discretion. In the event Vesper Marine chooses to replace the unit it may be replaced with a factory reconditioned unit or a new unit at its sole discretion. Where a replacement is provided the original product becomes the property of Vesper Marine and the warranty will remain from the original purchase date.

THE WARRANTIES AND REMEDIES CONTAINED HEREIN ARE EXCLUSIVE AND IN LIEU OF ALL OTHER WARRANTIES, WHETHER EXPRESS, IMPLIED OR STATUTORY, INCLUDING ANY LIABILITY ARISING UNDER ANY WARRANTY OF MERCHANTABILITY OR FITNESS FOR A PARTICULAR PURPOSE, STATUTORY OR OTHERWISE. THIS WARRANTY GIVES YOU SPECIFIC LEGAL RIGHTS, WHICH MAY VARY FROM STATE TO STATE.

IN NO EVENT SHALL VESPER MARINE BE LIABLE FOR ANY INCIDENTAL, SPECIAL, INDIRECT, OR CONSEQUENTIAL DAMAGES, WHETHER RESULTING FROM THE USE, MISUSE OR INABILITY TO USE THE PRODUCT OR FROM DEFECTS IN THE PRODUCT. SOME STATES DO NOT ALLOW THE EXCLUSION OF INCIDENTAL OR CONSEQUENTIAL DAMAGES, SO THE ABOVE LIMITATIONS MAY NOT APPLY TO YOU.

Vesper Marine retains the exclusive right to repair or replace the product or offer a full refund of the purchase price at its sole discretion. SUCH REMEDY SHALL BE YOUR SOLE AND EXCLUSIVE REMEDY.

## ***Warranty - Australia and New Zealand***

The AIS *WatchMate* is warranted, when properly installed and used, to be free from defects in materials or workmanship for two years from the date the product was purchased by the first retail customer. This warranty applies to the original retail purchaser only and is not transferable. Within this period, Vesper Marine will, at its discretion, repair or replace any components which fail in normal use. Repairs or replacement will be made at no charge for parts or labour, provided that the customer shall be responsible for any transportation costs. This warranty does not cover failures due to abuse, misuse, accident, improper installation, unauthorized alterations or repairs, shipping damage, wear and tear, or corrosion.

This warranty will not apply if the product's external housing has been opened, the serial number or other labels have been removed or altered, the specified input voltage has been exceeded, or the external alarm maximum switched current has been exceeded. This warranty is void if the product has been operated with an incompatible GPS antenna or without a suitable VHF antenna.

This warranty is in addition to all other rights available to the consumer under any applicable statute and your statutory rights are not affected by this warranty.

Vesper Marine retains the exclusive right to repair or replace the unit or offer a full refund of the purchase price at its sole discretion. In addition, Vesper Marine retains the exclusive right to replace the unit with a factory reconditioned unit or a new unit at its sole discretion. Where a replacement is provided the original product becomes the property of Vesper Marine and the warranty will remain from the original purchase date.

This warranty applies only to products supplied new to you by a stockist or Vesper Marine and you have not bought the product for resale.

In no event shall Vesper Marine be liable for any incidental, special, indirect, or consequential damages, whether resulting from the use, misuse or inability to use the product or from defects in the product.

## **Warranty - European Union**

The AIS *WatchMate* is warranted, when properly installed and used, to be free from defects in materials or workmanship for two years from the date the product was purchased by the first retail customer. This warranty applies to the original retail purchaser only and is not transferable. Within this period, Vesper Marine will, at its discretion, repair or replace any components which fail in normal use. Repairs or replacement will be made at no charge for parts or labour, provided that the customer shall be responsible for any transportation costs. This warranty does not cover failures due to abuse, misuse, accident, improper installation, unauthorized alterations or repairs, shipping damage, wear and tear, or corrosion.

This warranty will not apply if the product's external housing has been opened, the serial number or other labels have been removed or altered, the specified input voltage has been exceeded, or the external alarm maximum switched current has been exceeded. This warranty is void if the product has been operated with an incompatible GPS antenna or without a suitable VHF antenna.

This warranty is in addition to all other rights available to the consumer under any applicable statute and your statutory rights are not affected by this warranty.

Vesper Marine retains the exclusive right to repair or replace the unit or offer a full refund of the purchase price at its sole discretion. In addition, Vesper Marine retains the exclusive right to replace the unit with a factory reconditioned unit or a new unit at its sole discretion. Where a replacement is provided the original product becomes the property of Vesper Marine and the warranty will remain from the original purchase date.

This warranty applies only to products supplied new to you by a stockist or Vesper Marine and you have not bought the product for resale.

In no event shall Vesper Marine be liable for any incidental, special, indirect, or consequential damages, whether resulting from the use, misuse or inability to use the product or from defects in the product.

## ***Obtaining Warranty Service***

To obtain warranty service, please contact us. If you are unable to contact Vesper Marine directly, then contact the dealer where you purchased the unit.

You must have the original sales receipt. Online auction confirmations are not acceptable as an original sales receipt.

Vesper Marine Ltd.  
PO Box 91164, Victoria Street West  
45 Sale Street, Freemans Bay  
Auckland 1142  
New Zealand

Phone: +64 (0)9 950 4848

Fax: +64 (0)9 950 4085

[www.vespermarine.com](http://www.vespermarine.com)

[support@vespermarine.com](mailto:support@vespermarine.com)

**You must contact Vesper Marine and obtain a return authorization before sending your unit in for repair.**