

Conext™ ComBox Communication and Monitoring Device

For Freedom SW Series of Products

Owner's Guide

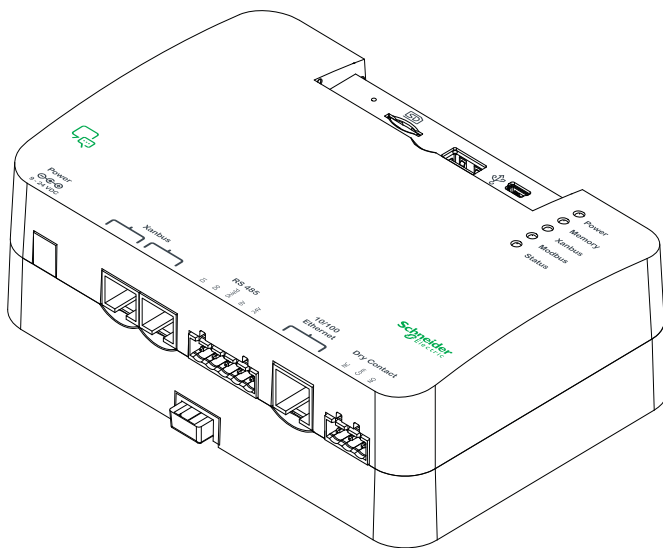

Exclusion for Documentation

UNLESS SPECIFICALLY AGREED TO IN WRITING, SELLER

(A) MAKES NO WARRANTY AS TO THE ACCURACY, SUFFICIENCY OR SUITABILITY OF ANY TECHNICAL OR OTHER INFORMATION PROVIDED IN ITS MANUALS OR OTHER DOCUMENTATION;

(B) ASSUMES NO RESPONSIBILITY OR LIABILITY FOR LOSSES, DAMAGES, COSTS OR EXPENSES, WHETHER SPECIAL, DIRECT, INDIRECT, CONSEQUENTIAL OR INCIDENTAL, WHICH MIGHT ARISE OUT OF THE USE OF SUCH INFORMATION. THE USE OF ANY SUCH INFORMATION WILL BE ENTIRELY AT THE USER'S RISK; AND

(C) REMINDS YOU THAT IF THIS MANUAL IS IN ANY LANGUAGE OTHER THAN ENGLISH, ALTHOUGH STEPS HAVE BEEN TAKEN TO MAINTAIN THE ACCURACY OF THE TRANSLATION, THE ACCURACY CANNOT BE GUARANTEED. APPROVED CONTENT IS CONTAINED WITH THE ENGLISH LANGUAGE VERSION WHICH IS POSTED AT WWW.SCHNEIDER-ELECTRIC.COM.

Document Number: 975-0704-01-01 **Revision:** Revision A **Date:** January 2014

Product Part Number: 809-0918

Contact Information www.xantrex.com

Information About Your System

As soon as you open your product, record the following information and be sure to keep your proof of purchase.

Serial Number _____

Product Number _____

Purchased From _____

Purchase Date _____

About This Guide

Purpose

The purpose of this Owner's Guide is to provide explanations and procedures for installing, operating, configuring, maintaining, and troubleshooting the Conext ComBox Communication and Monitoring Device for Freedom SW inverter/chargers and accessories.

Scope

The Guide provides safety guidelines, planning, and setup information, procedures for installing the Conext ComBox, as well as information about configuring, monitoring, and troubleshooting the unit. It does include information on how to use other Xantrex products.

Firmware Revision

Some Conext ComBox features and functions described in this guide may be incorporated with later firmware versions. This manual is valid for Conext ComBox – Freedom SW version 01.00 and above. To view the firmware version on your product, see the Conext ComBox Status Information in the web user interface.

Audience

The Guide is intended for use by anyone who plans to construct, install, or operate a system involving the Conext ComBox–Freedom SW. The information in this manual is intended for qualified personnel. Qualified personnel have training, knowledge, and experience in:

- Installing electrical equipment
- Applying all applicable installation codes
- Analyzing and reducing the hazards involved in performing electrical work
- Changing any TCP/IP-related settings

Organization

This Guide is organized into five chapters and an appendix.

Chapter 1, "Overview", describes physical features of the Conext ComBox and introduces the user interface.

Chapter 2, "Installation", describes how to install, wire, and connect the Conext ComBox to your network.

Chapter 3, "Configuration", describes how to configure and change device settings, manage data logs, import and export data, and upgrade firmware.

Chapter 4, "Monitoring", describes how to monitor LED indicator lights (LEDs), system and device levels, and create historical views.

Chapter 5, "Troubleshooting", describes how to interpret events and alerts.

Appendix A, “Specifications”, contains the electrical, mechanical and environmental specifications for the Conext ComBox.

Conventions Used

The following conventions are used in this guide.

⚠ DANGER

DANGER indicates an imminently hazardous situation, which, if not avoided, will result in death or serious injury.

⚠ WARNING

WARNING indicates a potentially hazardous situation, which, if not avoided, can result in death or serious injury.

⚠ CAUTION

CAUTION indicates a potentially hazardous situation, which, if not avoided, can result in moderate or minor injury.

NOTICE

NOTICE indicates important information that you need to read carefully.

Abbreviations and Acronyms

DHCP - Dynamic Host Configuration Protocol

LED - Light Emitting Diode (used for indicator lights)

SELV - Safety Extra Low Voltage

SNTP - Simple Network Time Protocol

TCP/IP - Transmission Control Protocol/Internet Protocol

Related Information

Related Products

For more information about related products, refer to:

Freedom SW Inverter/Charger Owner's Guide

Xanbus Automatic Generator Start Owner's Guide

Xanbus System Control Panel Owner's Guide

Freedom Sequence Owner's Guide

You can find more information about Xantrex products and services at **www.xantrex.com**.

Contents

Important Safety Instructions

1 Overview

Compatible Xanbus™ Components	1-2
Physical Features	1-3
Data Ports and Reset Button	1-3
LED Indicator Lights (LEDs)	1-4
Communication and Power Ports	1-5
Types of Conext ComBox Networks	1-6
Conext ComBox on a Local Area Network (LAN)	1-6
Conext ComBox with Remote Access	1-7
Power Sources for the Conext ComBox	1-7
User Interface	1-9
Home Screen	1-10
Menu Bar	1-11
Conext ComBox Setup Buttons	1-12
Other Buttons	1-13
System Scheduled Maintenance	1-13

2 Installation

Choosing a Location	2-2
Materials and Tools Required	2-3
Materials List	2-3
Additional Material and Tools	2-3
Mounting the Conext ComBox	2-4
Wall Mount	2-4
DIN Rail Mount	2-5
Wiring the RS 485 Modbus Connector for Data Communication	2-6
Wiring the Dry Contact Connector	2-8
Wiring the Conext ComBox to an Ethernet Network	2-9
Turning On the Conext ComBox	2-11
Connecting the AC/DC Power Adapter	2-12
Wiring the RS 485 Modbus Connector for Power to the Conext ComBox	2-12

Connecting to the Web Interface Using the Discovery Tool - - - - -	2-15
Connecting to the Web Interface Using a USB Thumb Drive - - - - -	2-16
Connecting to the Web Interface Using an Android Tablet- - - - -	2-17

3 Configuration

Configuration Steps - - - - -	3-2
Logging In- - - - -	3-3
Changing the Admin Password - - - - -	3-5
Changing the Time- - - - -	3-7
Changing E-Mail Settings - - - - -	3-9
Connecting the Conext ComBox to the Xanbus Network - - - - -	3-11
Changing Basic Conext ComBox Settings - - - - -	3-13
Control Panel - - - - -	3-14
Changing Advanced Conext ComBox Settings- - - - -	3-15
General Settings - - - - -	3-16
Change User Password Settings - - - - -	3-17
Change Admin Password Settings - - - - -	3-18
TCP/IP Settings - - - - -	3-18
E-mail Settings - - - - -	3-19
E-mail Reporting - - - - -	3-19
Web - - - - -	3-21
FTP - - - - -	3-22
FTP Logger - - - - -	3-23
Dry Contact Relay - - - - -	3-24
Suppress Device Faults/Warnings - - - - -	3-24
Xanbus Communications - - - - -	3-25
Modbus Communications - - - - -	3-25
Modbus Byte Order - - - - -	3-26
Modbus Address List - - - - -	3-27
Modbus Address Enumeration - - - - -	3-28
System Diagram - - - - -	3-30
Resetting the Conext ComBox to Factory Settings - - - - -	3-30
Changing Device Settings - - - - -	3-31
Using Cascading Parameters - - - - -	3-34

Upgrading Firmware - - - - -	3-35
Clearing the Internal Firmware Memory - - - - -	3-36
Installing Conext ComBox Upgrades from a Thumb Drive - - - - -	3-37
Installing Conext ComBox Upgrades Remotely - - - - -	3-39
Installing Xanbus Device Upgrades - - - - -	3-41
4 Monitoring	
Monitoring LEDs - - - - -	4-2
Startup - - - - -	4-2
Operating Mode - - - - -	4-3
Monitoring Conext ComBox Status Information - - - - -	4-3
Monitoring System Components - - - - -	4-6
Devices - - - - -	4-6
System Component Energy Graphs - - - - -	4-10
Interpreting a Battery Energy Graph - - - - -	4-12
Interpreting a Load Energy Graph - - - - -	4-13
Interpreting a Generator Energy Graph - - - - -	4-14
Managing Data Logs - - - - -	4-15
Accessing and Downloading Log Files - - - - -	4-17
5 Troubleshooting	
Viewing Xanbus Device Faults and Warnings - - - - -	5-2
Viewing System Events - - - - -	5-6
Viewing Faults and Warnings - - - - -	5-6
Browsing System Event and Fault Log Files - - - - -	5-7
Browsing Energy Log Files - - - - -	5-9
Common Solutions - - - - -	5-12
A Specifications	
Electrical Specifications - - - - -	A-2
Communication Interfaces - - - - -	A-2
Data Interfaces - - - - -	A-2
Power Supply (SELV or Class 2 Power Sources) - - - - -	A-2
Memory - - - - -	A-3
General Specifications - - - - -	A-3
Features - - - - -	A-4
Regulatory Approvals - - - - -	A-4
Schneider Electric Products that Work with the Conext ComBox - - - - -	A-4
Physical Dimensions - - - - -	A-5
Front View - - - - -	A-5
Side View - - - - -	A-5
Bottom View - - - - -	A-6
Back View - - - - -	A-6

Important Safety Instructions

READ AND SAVE THESE INSTRUCTIONS - DO NOT DISCARD

This guide contains important safety instructions for the Conext ComBox Communication and Monitoring Device for Freedom SW series of products (Part Number 809-0918). These instructions must be followed during installation and configuration procedures.

DANGER

HAZARD OF ELECTRIC SHOCK

- Read all instructions, cautionary markings, and all other appropriate sections of this manual before installing, operating, troubleshooting or performing maintenance on the Conext ComBox – Freedom SW.
- Exercise extreme caution at all times to prevent accidents.
- These instructions are for use by qualified installers only.

Failure to follow these instructions will result in death or serious injury.

DANGER

HAZARD OF ELECTRIC SHOCK AND FIRE

- Connect only to Safety Extra Low Voltage (SELV) circuits and power sources.
- All wiring must be done by qualified personnel to ensure compliance with all applicable installation codes and regulations.
- Do not expose the Conext ComBox Freedom – SW to rain, snow, spray, or bilge water.
- Do not disassemble. No user serviceable parts inside.
- Do not install and/or operate in compartments containing flammable materials or in locations that require ignition-protected equipment.

Failure to follow these instructions will result in death or serious injury.

NOTICE

EQUIPMENT DAMAGE

- All cables connected to the Conext ComBox – Freedom SW must run indoors and not be susceptible to lightning strikes.
- Turn OFF all devices before connecting cables. The Conext ComBox does not have an ON/OFF switch.
- Do not connect an Ethernet cable from the Conext ComBox to the WAN/MODEM port on the network router.
- Do not connect an Ethernet cable plug into a Xanbus port on the Conext ComBox.
- Do not connect a Xanbus RJ-45 cable plug into the 10/100 Ethernet port of the Conext ComBox.
- Do not connect any port on the Conext ComBox to an outside line or to a public telecommunication network.
- Ensure that the device connected on the Xanbus network is in standby mode before changing settings. Do not change any settings unless you are familiar with the device.
- Changes to any TCP/IP-related settings should only be performed by a qualified IT professional.

Failure to follow these instructions can damage equipment or affect network performance.

NOTICE

EQUIPMENT DAMAGE

- Do not disassemble the Conext ComBox – Freedom SW.
- See Warranty for instructions on obtaining service.
- The Conext ComBox contains no user-serviceable parts. Attempting to service the Conext ComBox yourself will void your warranty.

Failure to follow these instructions can damage equipment.

Important: This device can be configured to connect to the Internet using port-forwarding in your network router's settings. There is a security risk in port-forwarding unencrypted network traffic over a public network (Internet). Use of a VPN or a secure tunnel to route Conext ComBox communication via the Internet is recommended.

1

Overview

Chapter 1 describes the features of the Conext ComBox – Freedom SW and provides an overview of the physical features and web user interface.

It includes:

- Compatible Xanbus™ Components
- Physical Features
- Types of Conext ComBox Networks
- Power Sources for the Conext ComBox
- User Interface
- System Scheduled Maintenance

The Conext ComBox Communication and Monitoring Device (Part Number 809-0918) is an accessory compatible with the Freedom SW series of products. It provides an overall view of system performance for mobile power monitoring systems such as commercial, emergency and recreational vehicles, marine vessels, construction and other heavy duty applications.

The Conext ComBox – Freedom SW lets you configure the system and devices, monitor performance, and access data logs through a web-based application on a PC, laptop or Android tablet.

Other features of the Conext ComBox include:

- Compatibility—connects directly to Xanbus-enabled devices
- Real-time clock—keeps time for the entire system
- Non-volatile memory—preserves the latest Conext ComBox settings if power is interrupted or network communication is disrupted.
- Micro-SD slot—provides additional data storage.
- Firmware storage and upgrade capability—uses the Conext ComBox to upgrade or downgrade firmware for Xanbus-enabled devices on the network.

Important: This model of Conext ComBox is intended for connection to Freedom SW products only, and is not compatible with other Schneider Electric inverter products. Freedom SW products do not support grid tie or grid support functions. Although Modbus features are available in this ComBox model, Xantrex does not provide technical support for these features.

Compatible Xanbus™ Components

The Conext ComBox works with several Xantrex and Schneider Electric products including:

- Freedom SW inverter/chargers
- Xanbus System Control Panel (SCP)
- Xanbus Automatic Generator Start (AGS)
- Freedom Sequence power management system

Note: For details on specific models supported, see the “Specifications” section. The Conext ComBox supports up to a maximum of 20 devices on a Xanbus network depending on the device types.

Physical Features

The following illustration shows the Conext ComBox. The tables in the following sections contain descriptions of the connectors, indicators, and data ports.

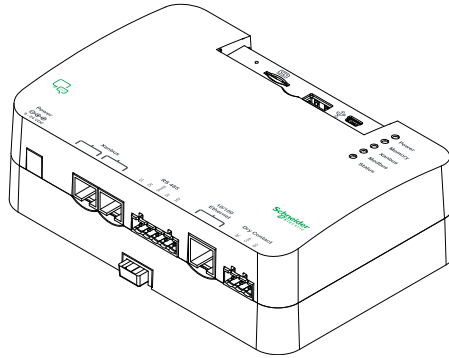

Data Ports and Reset Button

The data ports and reset are located at the top, front of the Conext ComBox. Their functions are listed in the following table.

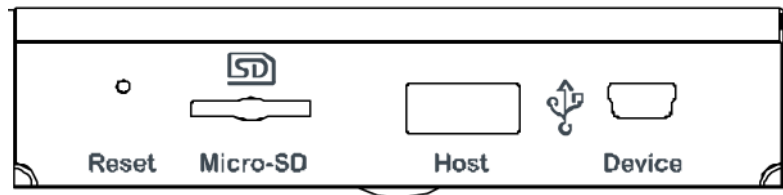

Item	Description
Reset	The Reset pinhole is used to restore factory settings or clear internal firmware memory. See “Resetting the Conext ComBox to Factory Settings” on page 3–30 and “Clearing the Internal Firmware Memory” on page 3–36.
Micro-SD	The Micro-SD data port is used with a micro-SD card to extend Conext ComBox memory for data logging.
Host	The Host USB data port is used for uploading firmware upgrades into the device - a thumb drive or equivalent mass storage device can be used. See “Clearing the Internal Firmware Memory” on page 3–36.
Device	The Device USB data port is used for transferring files from the Conext ComBox to a PC.

LED Indicator Lights (LEDs)

The Power LED flashes slowly (2 flashes per second) during the Conext ComBox application loading and flashes quickly during application initialization. The other LEDs light up one by one as the startup progresses. Once the Conext ComBox is ready, the power LED is on and other LEDs behave as described below. See “Monitoring LEDs” for more information.

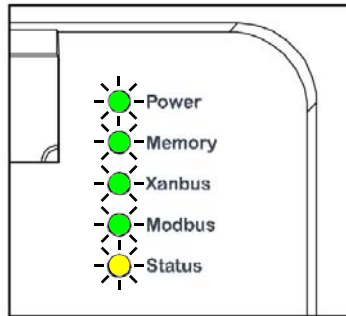

Item	Description
Power	Green LED. The Conext ComBox is powered and ready to communicate when on.
Memory	Green LED. Device is logging data to internal memory when flashing.
Xanbus	Green LED. Device is actively communicating or transferring data with the Xanbus network when on.
Modbus	Green LED. Each flash indicates that the Conext ComBox received a message from the Modbus.
Status	Amber LED. Devices on the Conext ComBox system have events or alerts when on.

Communication and Power Ports

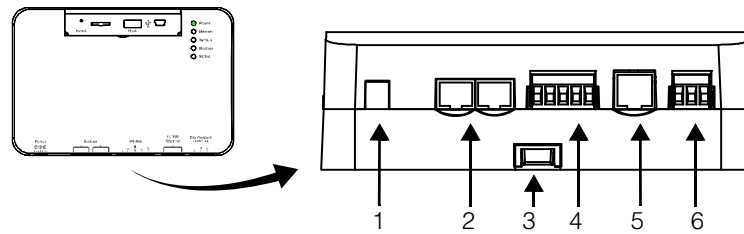

Item	Description
1	Power port. Use an AC/DC power adapter connected to a wall outlet to provide power to the Conext ComBox.
2	Xanbus ports. Plug in a CAT5 cable from Xanbus-enabled devices for communications and/or power to the Conext ComBox.
3	DIN rail sliding catch. Slide up/down to lock/release the Conext ComBox to a DIN rail.
4	RS 485 Modbus port. Use the RS 485 Modbus connector from a Modbus device for communications and 24V power terminals to the Conext ComBox.
5	10/100 Ethernet port for CAT5 cable only. Use to connect to a DHCP-enabled network router.
6	Dry Contact port. Used for signalling with SELV (Safety Extra Low Voltage) device. It does not provide power to the Conext ComBox.

See Chapter 2, "Installation" for more information on these ports.

Types of Conext ComBox Networks

The Conext ComBox can interface with different LAN devices using wired or wireless connections, so you can configure your Xanbus devices and monitor your power system performance. For this version of Conext ComBox – Freedom SW, there are two communication network options:

- Conext ComBox on a Local Area Network (LAN)
- Conext ComBox with Remote Access

Conext ComBox on a Local Area Network (LAN)

When the Conext ComBox is part of a LAN, you can access the Conext ComBox web user interface from a computer on the same LAN or through a wireless or wired LAN connection. For configuring the Conext ComBox, an Ethernet connection is required between the Conext ComBox and a router and computer.

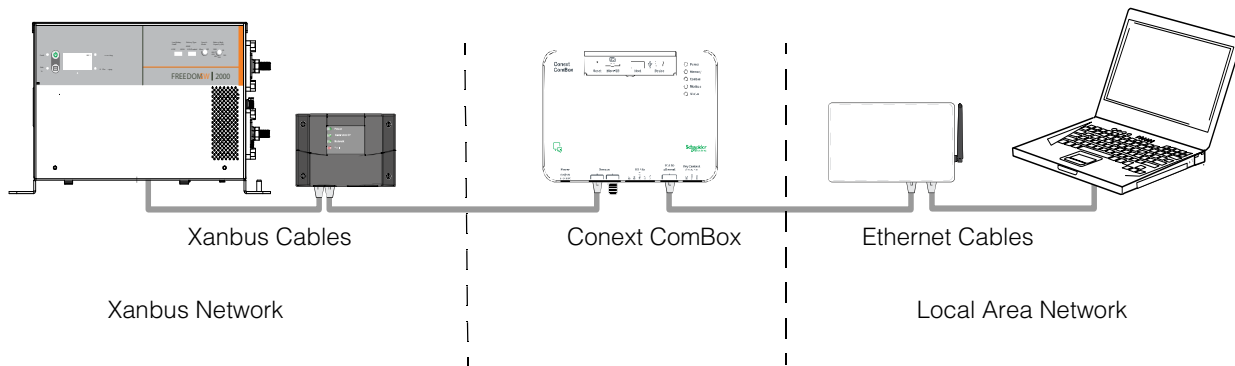

Conext ComBox with Remote Access

You can access the web user interface for the Conext ComBox from a remote computer using the Internet. The Conext ComBox must be connected to a router. The router firewall settings must allow port forwarding, which allows the remote computer to access the Conext ComBox using the router's IP address and the port number for the Conext ComBox.

Note: There is a security risk in port forwarding unencrypted network traffic over a public network (Internet). It is recommended you use a VPN or a secure tunnel to route Conext ComBox communication via the Internet.

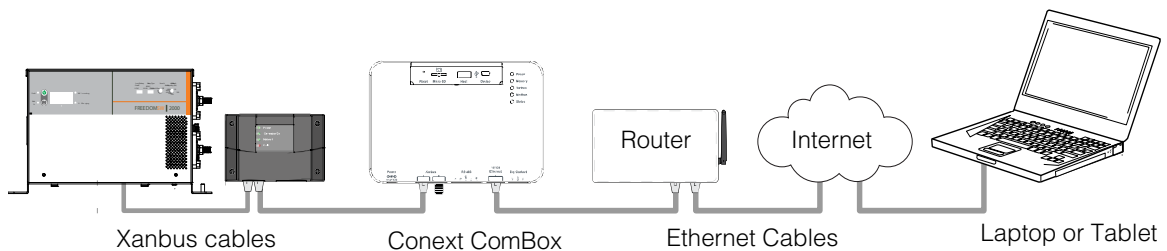

Power Sources for the Conext ComBox

The Conext ComBox consumes an average of 2 W under most operating conditions and up to 10 W maximum. The power sources connected to the Conext ComBox must be capable of providing this power requirement.

There are three power sources for the Conext ComBox:

- AC/DC power adapter (supplied)
- Freedom SW inverter/charger via CAT5 or CAT5e cable (Xanbus cable)
- 24 V DC power input connections on the RS 485 Modbus connector

All three sources can be used alone or simultaneously. Typically, the supplied AC/DC power adapter is used as a primary source with either a Xanbus or a RS 485 Modbus connection as secondary sources.

Note: Modbus support is available only for the Conext ComBox (Part Number 865-1058), and Conext Modbus Converter (Part Number 865-1059), used with Schneider Electric Conext series inverter products.

The RS 485 Modbus connector supplied with this Conext ComBox – Freedom SW (Part Number 809- 0918), is not required for operation or supported by Xantrex technical support.

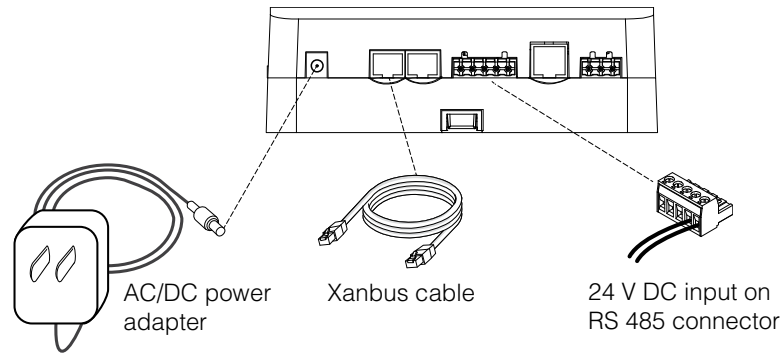

⚠ DANGER

HAZARD OF ELECTRIC SHOCK AND FIRE

Connect only to Safety Extra Low Voltage (SELV) circuits and power sources.

Failure to follow these instructions will result in death or serious injury.

Safety Extra Low Voltage (SELV) is a designation that refers to a circuit in which the voltages within the circuit and from the circuit to ground have values that are not a shock hazard, under both normal and single fault conditions. In the Conext ComBox, the SELV circuits and their intended connections are:

- Supplied AC/DC power adapter connected to the power port of the Conext ComBox.
- Xanbus communications and power which come from SELV circuits on Xanbus-enabled Schneider products.
- 24 V DC power input connections which must be SELV and are connected to the Conext ComBox via the RS 485 Modbus connector.
- SELV Ethernet circuits or Class 2 circuits (Class 2 is a 24V, 100VA limited circuit).
- An external SELV circuit connected via the Dry Contact connector (see “Wiring the Dry Contact Connector” on page 2–8).

User Interface

This section describes the elements of the web-based user interface for the Conext ComBox. This interface is used to check the status of the Conext ComBox, configure, monitor and log data for your network, and perform upgrades. The menu bar contains icons for all functions plus home, close and setup icons.

To access the web user interface, log in with a user name and password. For more details see “Logging In” on page 3–3.

Web browsers

Correct operation of the web interface has been verified with the following browsers:

- Mozilla Firefox 12.x or later
- Microsoft Windows Internet Explorer 8.x or later*
- Google Chrome 18.x or later
- Safari 5.x or later
- Android 4.0 or later (Ice Cream Sandwich)

Other browsers have not been tested and may have varying degrees of compatibility with the Conext ComBox.





*Internet Explorer 8.0 and 9.0 do not support firmware upgrade.

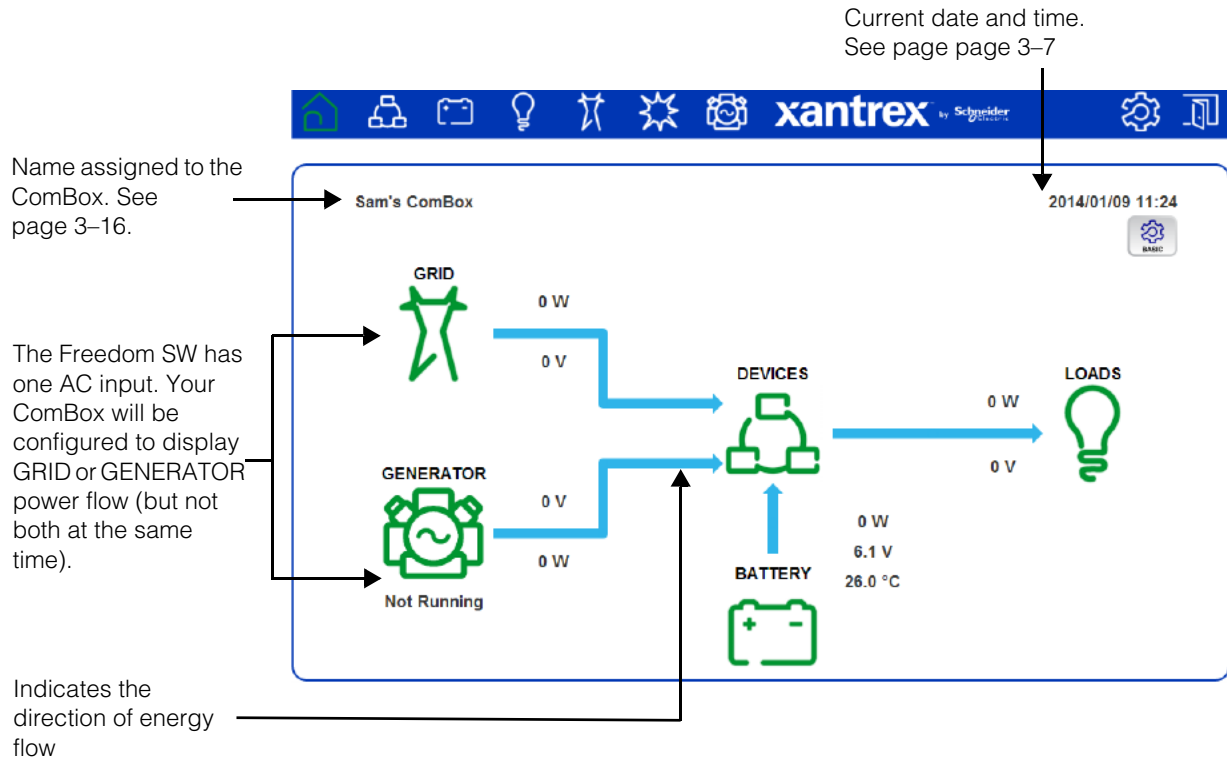

Note: JavaScript and cookies must be enabled in your Web browser for the interface to function.

Home Screen





Note: Although the Conext ComBox interface is displayed in a web browser, it does not use the Back button to display previous screens. All navigation through the interface is done within the Home screen.

Item	Description
	Displays basic settings for configuring the Conext ComBox for use with the Freedom SW inverter/charger and Xanbus AGS.
	Displays all power system devices connected to the ComBox. A yellow flashing device icon indicates a warning. A red flashing icon indicates a fault. Click a device icon to view a system status summary.
	Shows battery status such as voltage, current, power, temperature, charge cycle information and historical information.
	Shows the load status for the system and devices including power, apparent power, voltage, current, and frequency.

	Shows the status of generator input energy
	This feature is reserved for future use. A Xanbus-enabled solar charge controller certified for use on a vehicle or boat is not currently available.
	Shows the status of AC shore power from the main utility grid.





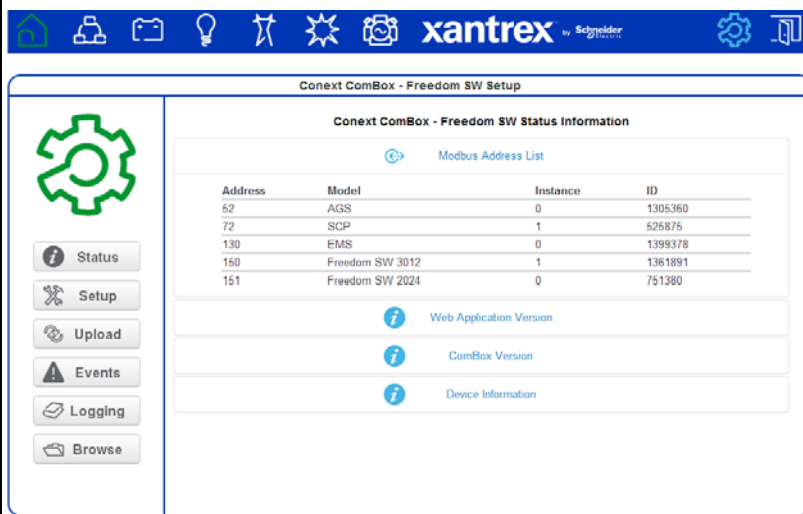

Menu Bar



Item	Description
	Returns you to the Home menu.
	Displays the Conext ComBox Status Information screen. Click the Setup button in the left side menu to open the Conext ComBox Setup screen.
	Links to xantrex.com.







In the Conext ComBox Setup screen, you can configure ComBox settings such as Time Zone and Network Settings. For more information, see “Conext ComBox Setup Buttons”.

	Closes the Conext ComBox web user interface and logs out.
	Shows Xanbus Devices of all types in the network.
	Shows the battery status for the network.
	Shows system AC output power, voltage and current (loads).
	Shows the status of AC shore power from the public utility grid.
	This feature is reserved for future use. A Xanbus enabled solar charge controller certified for use on a vehicle or boat is not currently available.
	Displays the status of generator input energy.

Conext ComBox Setup Buttons



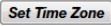

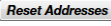
These buttons are found in the Conext ComBox Setup screen.

Item	Description
 Submit	Saves a parameter's new value to the Conext ComBox.
	Recalls (or refreshes) a parameter's previous value that is still not saved (or that may have been changed by another device).
Send	Found in E-mail-related settings, the Conext ComBox sends information out via the e-mail system.
Sync	Found only in the Network Time (SNTP) setting, this button performs a manual network time synchronization.
Reboot	Found only in General Settings, this button reboots the Conext ComBox.
Shutdown	Found only in General Settings, this button shuts down the Conext ComBox.
	Captures the most up-to-date value from a parameter.
Set Time	Sets the time and date in the Conext ComBox.

	Sets the time zone in the Conext ComBox.
	Found only in FTP Logger Settings, this button sends a sample log file to an FTP site.
	Causes a physical indicator on the Xanbus device to flash, light up, or beep, depending on the device.
	Found only in Modbus Address List Settings, this button resets the Modbus addresses of Xanbus devices.

Other Buttons

These buttons are found in other Conext ComBox web user interface screens, such as Upload screens and dialog screens.

Item	Description
	Found in Firmware Uploads And Device Upgrades, this button uploads an upgrade file from a storage device to the Conext ComBox.
	Found in Firmware Uploads And Device Upgrades, this button initiates the device upgrade process for a Xanbus device.
	When visible this provides the option to cancel a prompted action.
	Enacts an action prompted by a dialog screen.
	Closes a user interface screen or a pop-up application.

System Scheduled Maintenance

The Conext ComBox is unavailable for approximately three minutes at 3:05 AM daily. During this time, the Conext ComBox performs routine maintenance and does not respond to queries via any of its external interfaces, such as Modbus TCP, RS 485, Web Services, and Web Pages. Data logging is also suspended during this period.

2

Installation

Chapter 2 describes how to install, wire, and connect the Conext ComBox – Freedom SW to your network.

It includes:

- Choosing a Location
- Materials and Tools Required
- Mounting the Conext ComBox
- Wiring the RS 485 Modbus Connector for Data Communication
- Wiring the Dry Contact Connector
- Wiring the Conext ComBox to an Ethernet Network
- Turning On the Conext ComBox
- Connecting to the Web Interface Using the Discovery Tool
- Connecting to the Web Interface Using a USB Thumb Drive
- Connecting to the Web Interface Using an Android Tablet

Choosing a Location

Choose a clean, dry, easily accessible location indoors.

If you mount the Conext ComBox on a wall, the recommended height is at eye-level so that you can clearly see the LEDs and have easy access to the data ports.

All the communication ports on the Conext ComBox are accessible from the bottom of the device when mounted on a wall or DIN rail. Clearance of at least 2 inches (50 mm) below the device is needed to allow for the bending radius of cables that connect to the Conext ComBox.

You should not run cables through conduits that can be exposed to lightning strikes.

The following are recommended maximum cable lengths in a Conext ComBox system:

- 131 feet (40 m) Total Xanbus network
- 328 feet (100 m) Router to Conext ComBox
- 164 feet (50 m) Modbus Master (RS 485) to Conext ComBox

⚠ DANGER

HAZARD OF ELECTRIC SHOCK AND FIRE

- Connect only to Safety Extra Low Voltage (SELV) circuits and power sources.
- All wiring must be done by qualified personnel to ensure compliance with all applicable installation codes and regulations.
- Do not expose the Conext ComBox – Freedom SW to rain, snow, spray, or bilge water.
- Do not disassemble. No user serviceable parts inside.
- Do not install and/or operate in compartments containing flammable materials or in locations that require ignition-protected equipment.

Failure to follow these instructions will result in death or serious injury.

Materials and Tools Required

Materials List

The following materials are supplied in the Conext ComBox package:

- Conext ComBox unit
- Conext ComBox Quick Start Guide*
- AC/DC power adapter (PN: 0J-921-0023-Z) with replaceable multi-plug for North America, Europe, Asia, UK
 - 5.5 mm diameter (outer, negative), 2.1 mm diameter (inner, positive) connector
 - 12 VDC (output), 1.5 ADC
- Dry contact connector
- RS 485 Modbus connector
- Ethernet cable (2 m)
- USB cable (1.8 m)
- Xanbus network terminator
- Mounting hardware

Additional Material and Tools

The following materials and tools are not supplied but are required to complete the installation:

- CAT5 or CAT5e network cable(s) for Xanbus connections - 6.5 feet (2 m) or longer
- Modbus network cable(s)
- Wire stripper
- Ferrules

For wall mount:

- Two #6 (or equivalent) mounting screws for non-drywall mounting
- Screwdriver set

For DIN rail mount:

- 35-mm “top hat” DIN rail (EN50022)
- Pliers
- Diagonal cutter or heavy duty scissors

Mounting the Conext ComBox

Wall Mount

To mount the Conext ComBox on a wall:

1. Choose the location for mounting the device. Mounting hardware for plywood wall material is supplied.
2. Using the template in the *Conext ComBox Quick Start Guide*, mark the mounting holes on the wall with a pencil. The holes must be at the same height and 4 7/16 inches (112 mm) apart.
3. Insert the mounting screws supplied in the marked locations on the wall, leaving a space of about 1/4 inch (6 mm) between the wall and screw head.

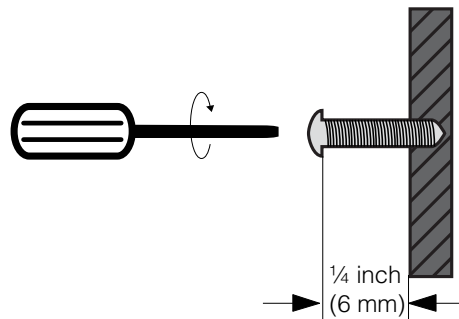

4. Place the Conext ComBox on the mounting screws, and confirm a snug fit before going to the next step.

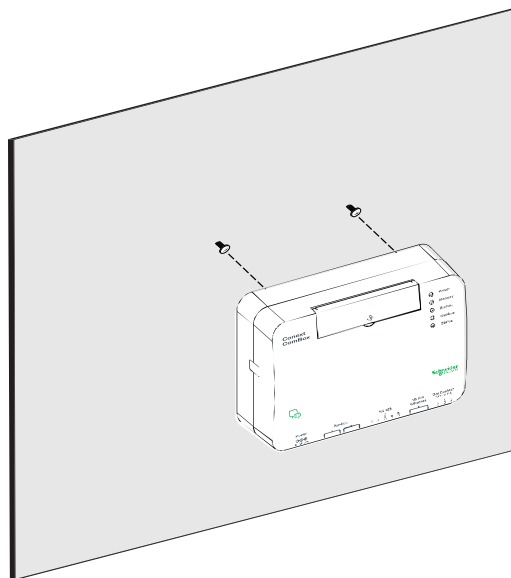

5. Connect the wiring and cables. Go to “Wiring the Conext ComBox to an Ethernet Network” on page 2–9.

DIN Rail Mount

A standard 35-mm “top hat” DIN rail (EN50022) must be used for mounting.

To mount the Conext ComBox on the DIN Rail:

1. Choose the location for mounting the device.
2. Using heavy duty scissors or a diagonal cutter, cut both ends of the side tab on one end of the Conext ComBox.

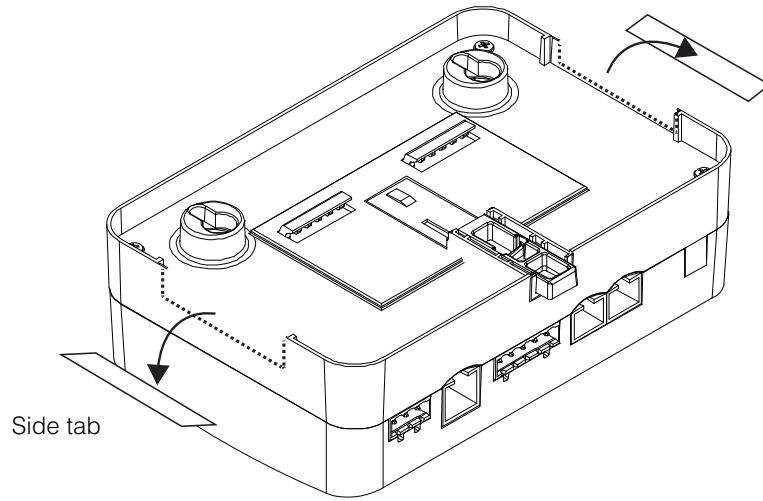

3. Break off the side tab. You may need to use pliers for this.
4. Repeat steps 2 and 3 for the tab at the other end of the Conext ComBox.
5. Use a suitable tool, such as a screwdriver, to pull down the catch on the bottom of the Conext ComBox.
6. Mount the Conext ComBox on the DIN rail and release the catch. See the following illustration.

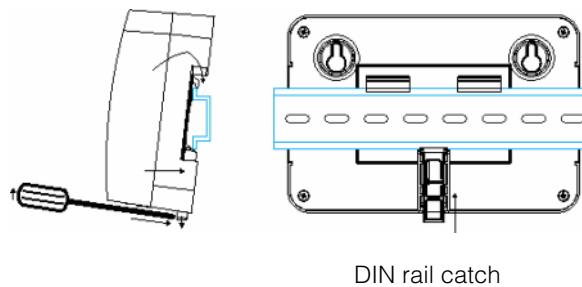

7. Connect the wiring and cables.

Wiring the RS 485 Modbus Connector for Data Communication

Note: Modbus support is available only for the Conext ComBox (Part Number 865-1058), and Conext Modbus Converter (Part Number 865-1059), used with Schneider Electric Conext series inverter products.

The RS 485 Modbus connector supplied with this Conext ComBox – Freedom SW (Part Number 809-0918), is not required for operation or supported by Xantrex technical support.

The RS 485 Modbus connector provides three terminals to wire communication cables to the Conext ComBox. The five-terminal RS 485 connector uses the first three terminals for a data cable. The cable has a size of 16–24 AWG with 1.5 mm²–0.25 mm² wires. The cable can be shielded or non-shielded.

To wire the RS 485 Modbus connector for data communication:

1. Select a two-wire, twisted pair, shielded cable not longer than 164 feet (50 m). Refer to the local electrical code and application to select the insulation and temperature class of the cable to be used.
2. Strip 3/8 in. (10 mm) from the end of the wires to be connected and attach ferrules to the two signal wires (red and black in the following diagram).
3. Insert the ferrules and the shield wire into the connector terminals as shown in the following diagram.

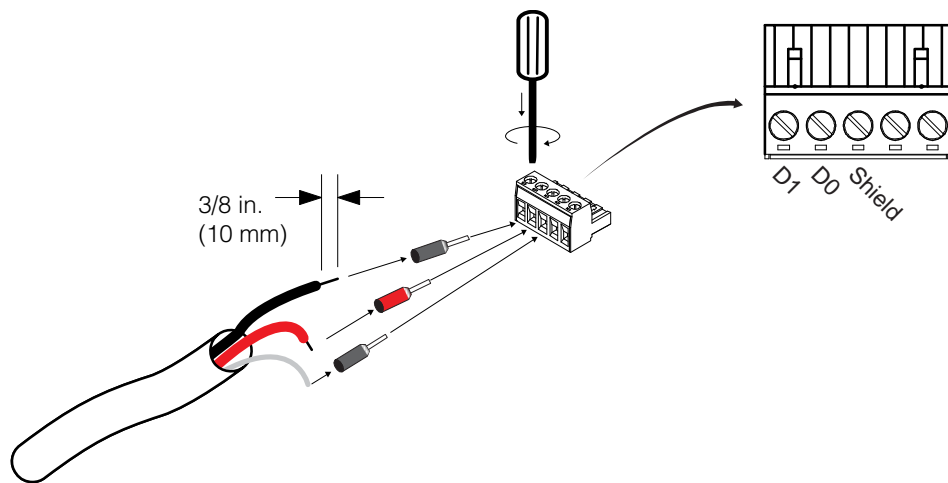

4. Secure the wires by tightening the screw on the terminal.
The middle terminal is not connected internally but is provided for the shield connection of the cable.
5. If you intend to use the Dry Contact, go to “Wiring the Dry Contact Connector”. Otherwise, go to “Wiring the Conext ComBox to an Ethernet Network”.

Modbus versus Xanbus

The RS 485 Modbus connection and Xanbus cable connection provide data communication from the network and devices to the Conext ComBox. Communication with Modbus devices is handled through the RS 485 or 10/100 Ethernet connection on the Conext ComBox while communication with Xanbus components occurs through the Xanbus ports of Xanbus-enabled devices.

Connecting the Conext ComBox with other Modbus Devices

In the Modbus implementation, the Conext ComBox acts as a slave to an RS 485 master device. The RS 485 connection to the Conext ComBox allows communication between the Xanbus network and the master device. This enables Conext devices to link to third-party software and building management systems.

If a Modbus device, including the Conext ComBox, is installed as the last device in a daisy chain, a 120 ohm terminator must be used because they do not have an internal terminator for the RS 485 network. When inserting two wires in one terminal, as in the case of daisy-chained RS 485 Modbus devices, use smaller gauge wires. See the following example.

Note: Turn off all Modbus and other devices prior to wiring the connectors.

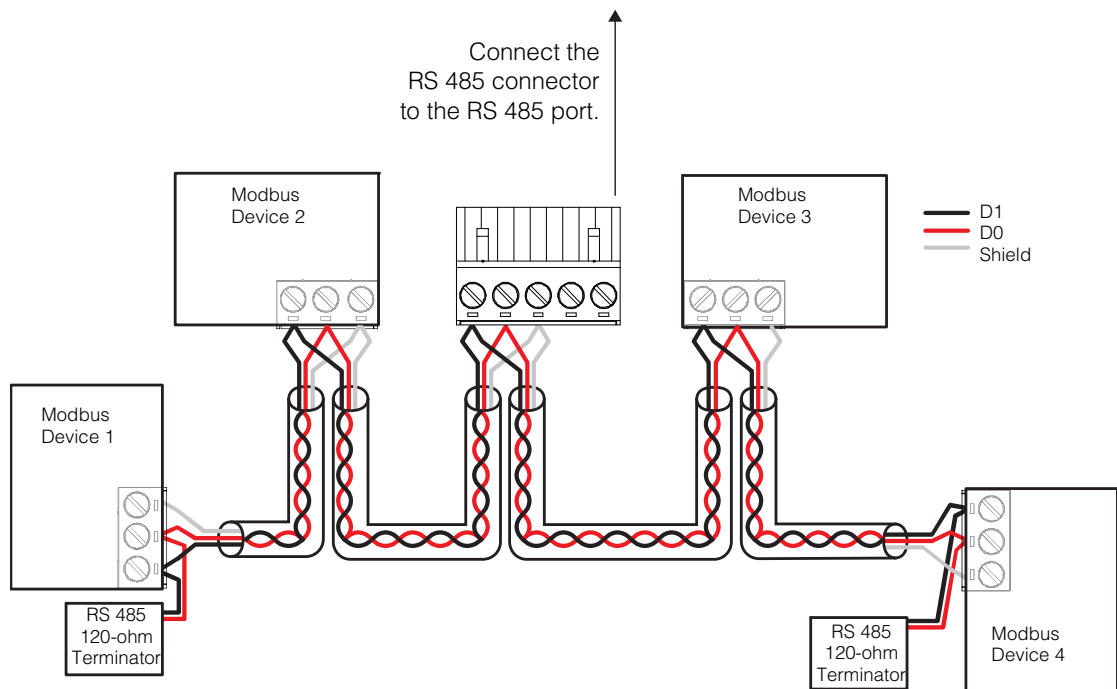

Wiring the Dry Contact Connector

Wiring instructions for dry contact wiring for SELV devices is included in this section. The dry contact connector is intended to control the trigger of SELV devices such as small DC fans or external AC or DC relays. It does not provide power to the Conext ComBox.

To wire the dry contact connector:

⚠ DANGER

ELECTRIC SHOCK AND FIRE HAZARD

- Turn off all other devices prior to wiring the connectors.
- The Dry contact port must only be connected to a circuit rated 24V DC max, 4A max, and supplied from an SELV source.

Failure to follow these instructions will result in death or serious injury.

1. Strip 3/8 in. (10 mm) from the end of the wire to be connected and attach ferrules to the bare wires.
2. Insert the ferrule into the Dry Contact connector's wire terminal.
3. Secure the wire by tightening the screw on the terminal.

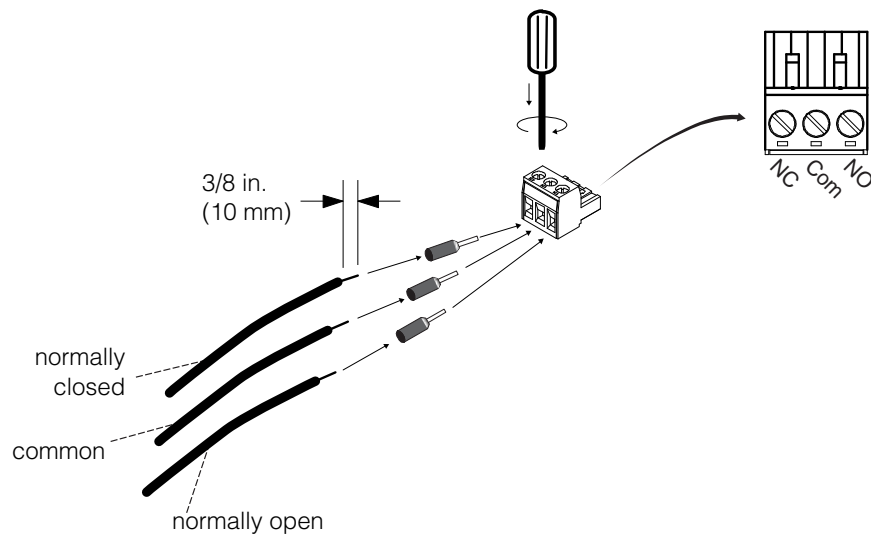

4. Repeat steps 2 and 3 for the remaining wires.

Note: The Dry Contact Connector should not be used for any safety-critical applications.

5. Once all the Dry Contact wires are secured, push the Dry Contact connector into the Dry Contact port until it locks into place.
6. Go to "Wiring the Conext ComBox to an Ethernet Network".

Wiring the Conext ComBox to an Ethernet Network

Note: The computer and network router may remain powered at this stage in the process. If not already powered, make sure these two devices are on before proceeding.

Before connecting a computer and router to the Conext ComBox, make sure it meets the following prerequisites.

Router

The network router must be able to supply DHCP addresses automatically to connected devices. If your network router does not support automatic DHCP, refer to your network router's user guide or contact your system administrator.

Operating System

- Microsoft® Windows® 7 (recommended) or later
- Microsoft® Windows XP® (SP2, SP3)
- Windows Vista® X86
- Mac OS® X 10.4.8. or later

Web Browsers

- Mozilla® Firefox® 12.x or later
- Microsoft® Windows® Internet Explorer® 8.x or later
- Google Chrome™ 18.x or later
- Safari® 5.x or later
- Android 4.0 or later (Ice Cream Sandwich)

Note: JavaScript and cookies must be enabled in your web browser.

To connect the Conext ComBox to a computer on an Ethernet network:

1. Make sure the computer and network router are turned on and the Conext ComBox is not turned on. Make sure the network router selected has DHCP enabled.
2. Connect one end of an Ethernet cable to the computer's network port.

NOTICE

<p>EQUIPMENT DAMAGE</p> <ul style="list-style-type: none"> • Do not connect an Ethernet cable from the Conext ComBox to the WAN/MODEM port on the network router. • Do not connect an Ethernet cable plug into a Xanbus port on the Conext ComBox. <p>Failure to follow these instructions can damage equipment.</p>
--

3. Connect the other end of the Ethernet cable to a vacant Ethernet/LAN port on the network router.

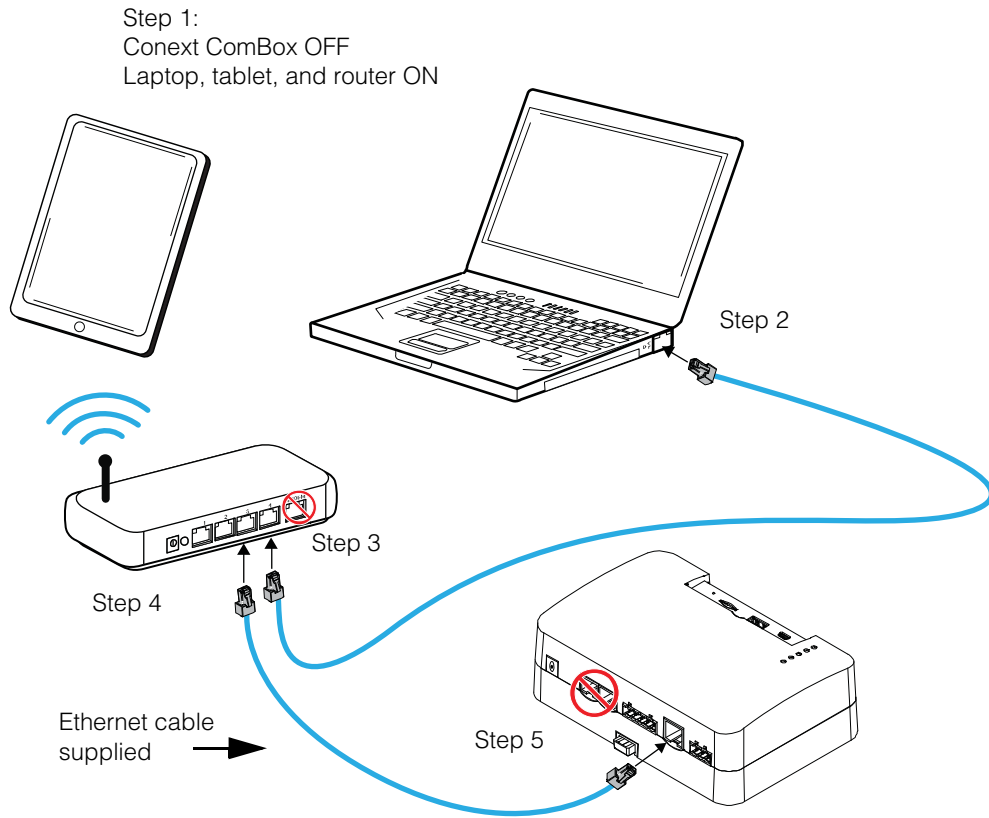

4. Connect one end of the Ethernet cable (supplied) to the LAN port on the network router.
At this stage, the network router should be on but the LED showing port activity on the router will not show any indication.
5. Connect the other end of the Ethernet cable to the Conext ComBox.
At this stage the Ethernet cable should be the only cable (except for the Dry Contact if used) plugged into the Conext ComBox.

Turning On the Conext ComBox

The Conext ComBox must be wired into an Ethernet connection before it is powered up. Follow the sequence of steps in “Wiring the Conext ComBox to an Ethernet Network” on page 2–9.

To turn on the Conext ComBox:

1. Connect a power source to the Conext ComBox. You can do either of the following:
 - Plug the AC/DC power adapter into the AC wall outlet (see “Connecting the AC/DC Power Adapter”), or
 - Plug the RS 485 connector, which has been wired with a 24 V DC power supply, to the RS 485 port on the Conext ComBox until it locks into place. See “Wiring the RS 485 Modbus Connector for Power to the Conext ComBox” for the wiring procedure.

Note: Modbus support is available only for the Conext ComBox (Part Number 865-1058), and Conext Modbus Converter (Part Number 865-1059), used with Schneider Electric Conext series inverter products.

The RS 485 Modbus connector supplied with this Conext ComBox – Freedom SW (Part Number 809- 0918), is not required for operation or supported by Xantrex technical support.

WARNING

PHYSICAL INJURY HAZARD

Xanbus is a valid power source for the Conext ComBox. However, for the initial configuration, using Xanbus as a power source is not recommended. The Conext ComBox clock will override the other Xanbus devices' clocks and could trigger unintentional time-based events. Therefore, DO NOT connect the Conext ComBox to the Xanbus network prior to setting up the internal clock of the Conext ComBox. Refer to “Changing the Time” on page 3–7. If Xanbus is the only source powering the ComBox, after installation verify the time settings in all devices.

Failure to follow these instructions can result in death or serious injury.

2. When power is applied to the Conext ComBox, all the LEDs flash once and then the Power LED flashes intermittently for approximately two minutes during the application loading and initialization sequence.
Wait until the Power LED lights up steadily before proceeding to the next step. See “LED Indicator Lights (LEDs)” on page 1–4.
3. When the Conext ComBox is ready, proceed to either “Connecting to the Web Interface Using the Discovery Tool” on page 2–15 or “Connecting to the Web Interface Using a USB Thumb Drive” on page 2–16.

Connecting the AC/DC Power Adapter

⚠ DANGER

ELECTRIC SHOCK AND FIRE HAZARD

Use only the AC/DC Power Adapter supplied with this Conext ComBox unit. When ordering a replacement, reference PN: 0J-921-0023-Z.

Failure to follow these instructions will result in death or serious injury.

To use the AC/DC power adapter supplied with the Conext ComBox as a power source:

1. Conext ComBox uses a universal plug with interchangeable pins and plug styles.

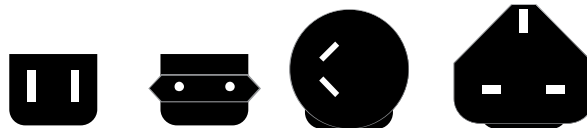

2. Connect the power plug to the AC outlet.
3. Connect the other plug of AC/DC power adapter to the Power port on the Conext ComBox.
4. Go to step 2 of “Turning On the Conext ComBox”.

Wiring the RS 485 Modbus Connector for Power to the Conext ComBox

Note: Modbus support is available only for the Conext ComBox (Part Number 865-1058), and Conext Modbus Converter (Part Number 865-1059), used with Schneider Electric Conext series inverter products.

The RS 485 Modbus connector supplied with this Conext ComBox – Freedom SW (Part Number 809- 0918), is not required for operation or supported by Xantrex technical support.

To use the Modbus RS 485 connector to provide power to the Conext ComBox, use the following procedure. When powering the Conext ComBox through the 24 V DC terminals on the RS 485 connector, use a power supply (AC/DC or DC/DC) that provides galvanic isolation to meet the required SELV connections.

⚠ DANGER**ELECTRIC SHOCK AND FIRE HAZARD**

If the power terminals on the Modbus RS 485 connector are used, the RS 485 connector must only be connected to a circuit rated 24V DC max, 1A max (fused on the positive wire), and supplied from an SELV source.

Failure to follow these instructions will result in death or serious injury.

NOTICE**EQUIPMENT DAMAGE**

Turn OFF all devices before connecting cables. The Conext ComBox does not have an ON/OFF switch. See “Power Cycle” below.

Failure to follow these instructions can damage equipment or affect performance.

Power Cycle**To power cycle the Conext ComBox:**

1. Turn the Conext ComBox OFF – perform a proper shutdown (see “Shutting down the Conext ComBox” on page 3–17) then unplug and disconnect it from all power sources.
2. Wait ten seconds before the next step.
Ensure that there is no USB thumb drive inserted in the USB Host port.
3. Turn the Conext ComBox ON – plug and connect it to a power source.

Wiring Steps**To wire the RS 485 Modbus connector for power to the Conext ComBox:**

1. Turn off the 24 V DC power supply.
2. Unplug the RS 485 connector from the RS 485 port on the Conext ComBox.
3. Strip 3/8 in. (10 mm) from the end of the 0 V (–) wire of the power cable.
4. Terminate the wire with a ferrule.
5. Install a 1A DC fuse on the 24 V (+) wire of the power cable and strip 3/8 in. (10 mm) from the end of the wire.
6. Terminate the wire with a ferrule.

7. Insert the ferrules into the Modbus connector's wire terminals as shown.

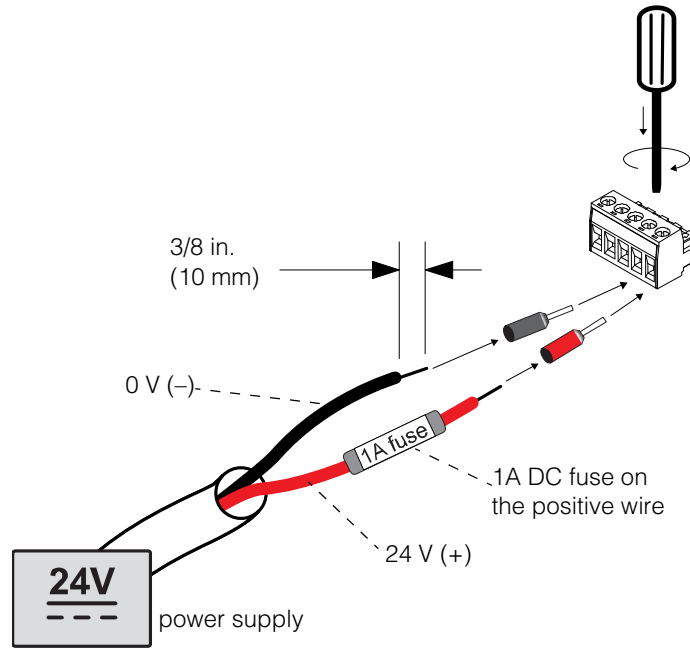

Note: The polarity of the wires is shown above and on the unit.

8. Secure the wires by tightening the screws on the terminal.
9. Plug the Modbus connector into the RS 485 port of the Conext ComBox.
10. Turn on the 24 V DC power supply.
11. Go to step 2 of "Turning On the Conext ComBox".

Connecting to the Web Interface Using the Discovery Tool

After the Conext ComBox is wired into and powered up on a LAN, it will exist as a LAN device at an IP address. The following procedure describes how to find the Conext ComBox LAN address using the Discovery Tool.

To find the Conext ComBox on your network:

1. Download the Discovery Tool from the website:
<http://xantrex.com/power-products/default/conext-combox-freedomsw>
2. Temporarily disable all antivirus software including firewall protection software running in the background.
3. Open the **Device Discovery Tool** folder.
4. Double-click **ConextComBoxLocator.jar**.

This tool requires Java Runtime Environment (JRE). If you see a message about this, go to <http://www.java.com/en/download/index.jsp> to download and install JRE.

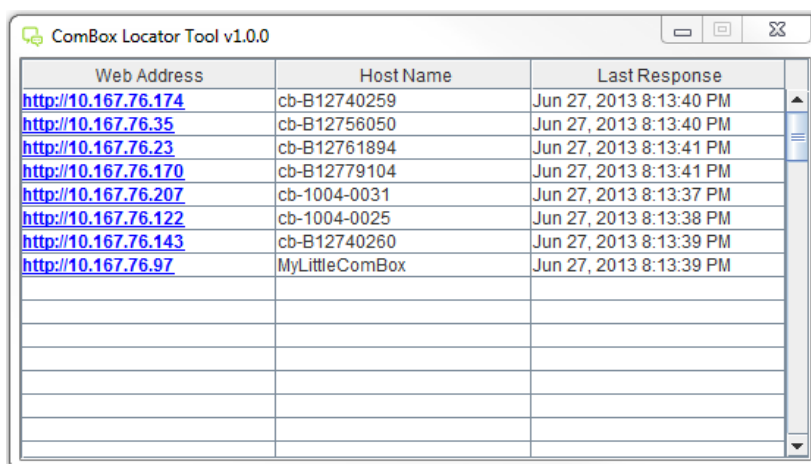

Web Address	Host Name	Last Response
http://10.167.76.174	cb-B12740259	Jun 27, 2013 8:13:40 PM
http://10.167.76.35	cb-B12756050	Jun 27, 2013 8:13:40 PM
http://10.167.76.23	cb-B12761894	Jun 27, 2013 8:13:41 PM
http://10.167.76.170	cb-B12779104	Jun 27, 2013 8:13:41 PM
http://10.167.76.207	cb-1004-0031	Jun 27, 2013 8:13:37 PM
http://10.167.76.122	cb-1004-0025	Jun 27, 2013 8:13:38 PM
http://10.167.76.143	cb-B12740260	Jun 27, 2013 8:13:39 PM
http://10.167.76.97	MyLittleComBox	Jun 27, 2013 8:13:39 PM

5. In the list that appears, click the **Web Address** for the Conext ComBox (cb-XXXX where XXXX is a factory- assigned number).

If a web browser opens up, you will see the Conext ComBox user interface Login window. Go to the next step.

The default value of the **Web Server Port** is 80. For example, if you change this value to 8080, you must append the URL address with “:8080” at the end of the IP address (e.g. <http://10.167.73.66:8080>).

If a web browser window does not open:

- Note the **Web Address** for the Conext ComBox.
- Open a web browser.
- Enter the Conext ComBox **Web Address** in the **URL** field.
- Press **Enter** on the keyboard. The Conext ComBox web interface Login window appears.

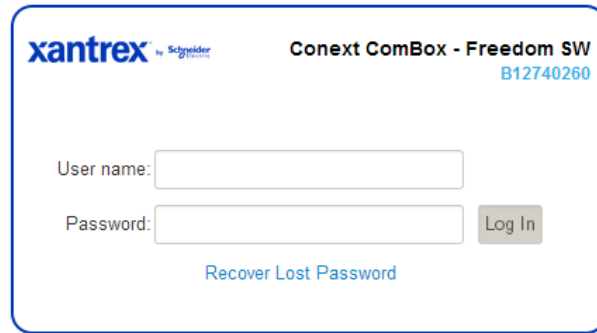

6. Enable all antivirus software including firewall protection software.
7. To complete configuration of your Conext ComBox, go to the “Configuration” section.

Connecting to the Web Interface Using a USB Thumb Drive

In cases where it is not practical to obtain the Conext ComBox’s IP address using the Device Discovery tool (or using the Windows network browser), obtain the IP address using a USB thumb drive.

To connect using a USB thumb drive:

1. Plug a USB thumb drive into the Conext ComBox’s USB Host data port while the Conext ComBox unit is powered on (the Power LED is steadily on and not flashing).
2. Watch the Memory LED and wait for it to flash quickly five times.
3. Remove the USB thumb drive from the USB Host data port.
4. Plug the USB thumb drive into your computer’s USB port.
5. Use the file system browser on your computer to navigate to the thumb drive’s root directory.
6. Look for a file named *serial number.html*, where *serial number* is the Serial Number of the Conext ComBox.
7. Double-click the *serial number.html* file. Your default web browser will launch and display the System Information screen.



Schneider
Electric

Conext ComBox - Freedom SW by Xantrex

System Information

Model Number:	809-0918
Serial Number:	B12740260
Hardware Revision:	Rev-C
Device Name:	Sam's ComBox

MAC Address:	00:06:D0:00:0B:BD
IP Address:	10.167.76.142
Hostname:	cb-B12740260

Software ID:	150-0288
Kernel Version:	1.31
Application Version:	Ver01.00BN9002
Application Build Date:	2014-01-14_14-58-44
Boot Loader Version:	Ver01.02BN0087
Boot Loader Build Date:	2013-08-23_09-40-38

Date and Time:	2014/01/15 12:31:18
Time Zone:	(-11.00)Midway-Island
Uptime:	33862

[Connect](#)

Xanbus Devices

Device	FGA #	Firmware	ID	Modbus Address

- Click the **Connect** button. The web browser opens and the Conext ComBox web interface Login window appears.

Note: Connecting to the web interface through the System Information screen only works if your computer is on the same Local Area Network as the Conext ComBox.

Connecting to the Web Interface Using an Android Tablet

If you want to use a tablet to access the web interface, you must install the Conext ComBox – Freedom SW mobile application available on Google Play.

The Conext ComBox mobile application is designed for tablets running Android 4.0 or later.

To connect using a tablet:

- Make sure that the Conext ComBox is turned on and that the router is connected to the internet with WiFi turned on.
- On the tablet home screen, tap the Google Play icon:



- In the Google Play store, search for **Conext ComBox Freedom SW**.
- Tap Install and follow the instructions on the screen to install the application.

3

Configuration

Chapter 3 describes how to configure settings for the Conext ComBox – Freedom SW. It also includes how to connect devices to the Xanbus network.

It includes:

- Configuration Steps
- Logging In
- Changing the Admin Password
- Changing the Time
- Changing E-Mail Settings
- Connecting the Conext ComBox to the Xanbus Network
- Changing Basic Conext ComBox Settings
- Changing Advanced Conext ComBox Settings
- Resetting the Conext ComBox to Factory Settings
- Changing Device Settings
- Upgrading Firmware

Configuration Steps

To complete Conext ComBox setup, you must successfully complete the procedures in Chapter 2, "Installation". Make sure the Conext ComBox is connected, the **Power** LED is on, and the **Status** LED is off. Your Xanbus devices should still be in standby mode.

When you log in to the web interface, most of the setup information appears automatically with their default values. Some information requires change (such as passwords), some information can be modified as needed, and some information can only be modified by a qualified IT professional.

The following items are part of the Conext ComBox configuration process:

Primary

- Log in - see "Logging In"
- Change the password - see "Changing the Admin Password"
- Set the time - see "Changing the Time"
- Enter e-mail information - see "Changing E-Mail Settings" and sending reports - see "E-mail Reporting"
- Connect the Conext ComBox to the Xanbus network - see "Connecting the Conext ComBox to the Xanbus Network"
- Configure basic ComBox settings in the control panel- see "Changing Basic Conext ComBox Settings"

Secondary

- Change TCP/IP settings if you want to use static IP addresses - see "TCP/IP Settings"
- Configure Conext ComBox settings - see "Changing Advanced Conext ComBox Settings"

Optional/ Occasional

- Clear the device memory - see "Clearing the Internal Firmware Memory"
- Upgrade the device firmware - see "Upgrading Firmware"

Logging In

The first time you log in to the Conext ComBox web user interface, use the default **User name: *admin*** and **Password: *password***.

NOTE: See “Two Types of Accounts” below.

Two Types of Accounts

User name	Password	Privileges
<i>admin</i>	<i>password</i>	System-level access. Lets you make changes to Conext ComBox settings and Xanbus device settings, and access all system monitoring, status, and logging tools.
<i>user</i>	<i>user</i>	Limited access. Lets you display system and status monitoring tools, and make basic changes to the Freedom SW configuration using the Basic settings button on the Home screen.

The Home screen appears after logging in successfully.

Note: The Freedom SW has one AC input. Your ComBox will be configured to display GRID or GENERATOR power flow (but not both at the same time).

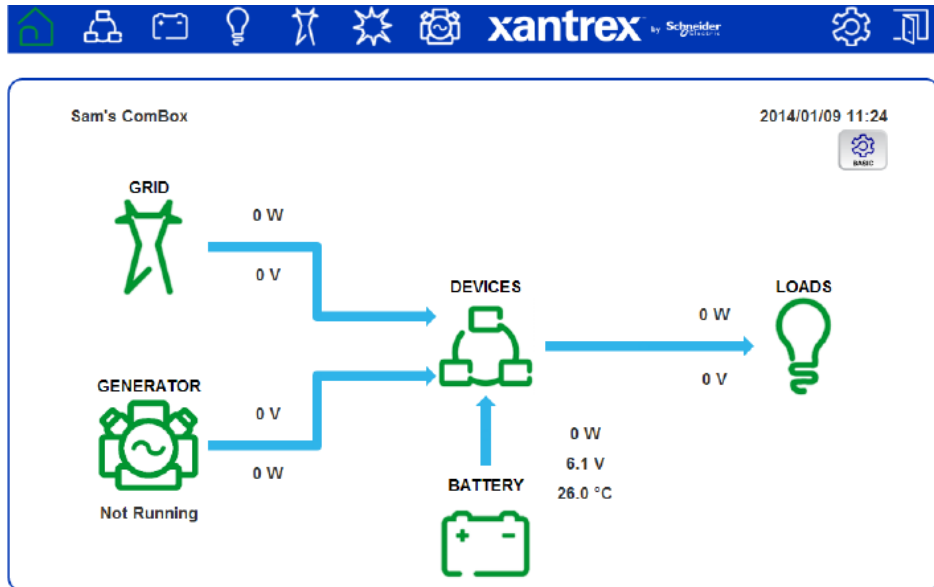



Once you log in, click  in the menu bar to change the password.

Changing the Admin Password

Change the password from the default “password” as soon as possible.

Changing the Admin password

To change the Conext ComBox Admin Password:

1. In the menu bar, click .
2. Click  **Setup** in the left side menu.
3. Under **Conext ComBox Settings**, click **Change Admin Password**.

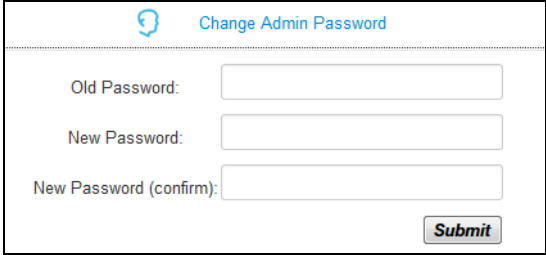

The screenshot shows a web form titled "Change Admin Password". It contains three input fields: "Old Password:", "New Password:", and "New Password (confirm):". A "Submit" button is located at the bottom right of the form.

4. Enter the **Old Password**.
5. Enter your **New Password**.
The password should contain at least eight alphanumeric (0-9, a-z, A-Z) characters with no special characters and spaces. Passwords are case-sensitive, and the maximum length is 32 characters.
6. Enter the **New Password (confirm)** again.
7. Click **Submit**.
A message indicates that the password change was successful.

Recovering the Admin password

To recover a Password:

If you forget the password, click **Recover Lost Password** in the Login window.

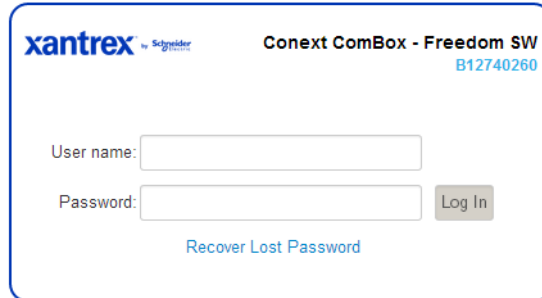

The screenshot shows a login interface for 'Conext ComBox - Freedom SW' (model B12740260). It features the Xantrex by Schneider logo in the top left. The main content area contains two text input fields: 'User name:' and 'Password:'. To the right of the password field is a grey 'Log In' button. Below the password field is a blue link labeled 'Recover Lost Password'.

An e-mail will be sent to the designated e-mail address(es) containing the current or a random temporary password for your Conext ComBox.

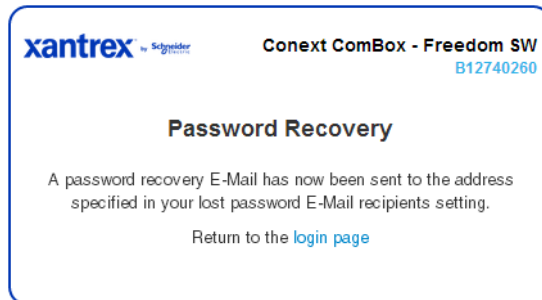

The screenshot shows a confirmation page for password recovery. It features the Xantrex by Schneider logo and the product name 'Conext ComBox - Freedom SW' (model B12740260). The heading is 'Password Recovery'. The main text reads: 'A password recovery E-Mail has now been sent to the address specified in your lost password E-Mail recipients setting.' At the bottom, there is a blue link labeled 'Return to the login page'.

Note: You must have the Conext ComBox **E-mail Settings** configured and connected to the internet for this feature to work. See “Changing E-Mail Settings” on page 3-9’.

Changing the Time

⚠ WARNING

PHYSICAL INJURY HAZARD

Be careful when changing the Conext ComBox time setting. It will override any time settings on individual Xanbus-enabled devices in the network. The time represents the entire system. Any appliance or equipment that is time-controlled by a Xanbus device, such as a generator connected to an AGS, can inadvertently turn on at the wrong time.

Failure to follow these instructions can result in death or serious injury.

You can also choose to use the network time for your system. If enabled, network time (SNTP) will override the Conext ComBox Time setting at the next SNTP polling update. See “Using Network Time” on page 3–8. The default setting has SNTP network time enabled (SNTP state is On).

Note: This date/time setting overrides settings on other devices in the system.

To set the Conext ComBox time and date:

1. On the Home screen, click  to display the Basic Settings control panel.

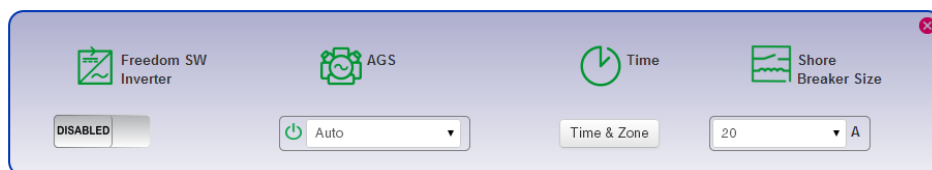

2. Click **Time & Zone** and then select the appropriate values. Click **Submit**.









Using Network Time

You can choose to use the network time for your Conext ComBox system. You must be logged on as Admin to access Network Time and other advanced settings.

Note: If you enable this option, it will replace any manual settings you set under Time and Zone at the next update according to the SNTP poll setting.

To use the network time and date:

1. Log in as Admin, and in the menu bar, click .
2. Click  **Setup** in the left side menu.
3. Under **Conext ComBox settings**, click **Network Time (SNTP)**.
4. In **SNTP Server Name**, enter the IP address or URL of the network time server, (**pool.ntp.org** is recommended) and then click .
5. In **SNTP Poll Interval**, enter (in hours) how often you want to update the Conext ComBox system time to the network time and then click .
6. To enable the automatic network time setting, select **SNTP State On** and then click .
- To disable the automatic network time setting, select **SNTP State Off** and then click .
7. To perform a manual network time synchronization (SNTP State must be On), click  under **Perform SNTP Synchronization**.

Changing E-Mail Settings

If you forget your password and want to have it sent to you, you must provide a an e-mail address. Lost password recovery is not possible without first setting up a valid e-mail address and enabling e-mail notification.

Note: E-mail Settings is a networking feature that requires a Local Area Network with Internet access. If you do not have Internet access through your router, this feature is not available.

E-Mail Settings

Parameter	Value	
Mailer Status	Enabled ▾	↻ ⏏
E-Mail Server Address	mailserver.yourdomain.com	↻ ⏏
E-Mail Server Port	25	↻ ⏏
E-Mail Recipients	 	↻ ⏏
E-Mail Authentication	Disabled ▾	↻ ⏏
E-Mail User ID	user@yourdomain.com	↻ ⏏
E-Mail Password	<div style="display: flex; justify-content: space-between;"> (New) (Confirm) </div>	↻ ⏏
Lost Password E-Mail Recipients	 	↻ ⏏
Lost Password E-Mail From Address	no-reply@schneider-electric.com	↻ ⏏
Reset Lost Passwords	No ▾	↻ ⏏
Send Test E-mail	Send	

Mailer Status

Activate or deactivate e-mailing features. When enabled, a user who forgets a password when trying to log in can have the Conext ComBox send the current password or a randomly generated temporary password by e-mail.

E-mail Server Address	Specify the mail server address provided by the Internet service provider. It has the format <i>mailserver.yourdomain.com</i> . Contact your Internet service provider for the correct information.
E-mail Server Port	Specify the port number used by a computer to transmit electronic data through the Internet. The number 25 is typically reserved for e-mail.
E-mail Recipients	Enter multiple e-mail addresses separated by a comma and no space. Any address listed here will receive e-mail messages generated by the Conext ComBox.
E-mail Authentication	Enable or disable an external e-mail's authentication settings. When enabled, you have to supply the E-mail User ID and E-mail Password below.
E-mail User ID	Specify the external e-mail account's user ID, which is usually the full e-mail address that includes the domain name.
E-mail Password	Specify the external e-mail account's password.
Lost Password E-Mail Recipients	Specify a valid e-mail address where the current password or a random temporary password can be sent. For multiple e-mail recipients, separate the addresses with a comma and no space.
Lost Password E-Mail From Address	Specify a valid e-mail address that can be used as an identifier of the sender. Generally, the sender is also the user of the Conext ComBox. By default, this is set to <i>no-reply@schneider-electric.com</i> and typically does not need to be changed.
Reset Lost Passwords	Select No to send the current password by e-mail. Select Yes to generate a random temporary password to be sent by e-mail.

Send Test E-Mail

Test that the e-mail settings above have been configured correctly.

Press the  button to send a sample e-mail message to the addresses listed in the **E-mail Recipients** parameter. Mailer Status must be enabled for the button to work.

Connecting the Conext ComBox to the Xanbus Network

After you install and configure the Conext ComBox, you can connect it to the Xanbus network. The Xanbus network cable (a CAT5 cable), can provide both data communication and power from Xanbus-enabled devices.

Important: Make sure the ComBox clock is configured before connecting ComBox to the Xanbus network. See “Changing the Time” on page 3–7.

Xanbus is a valid power source for the Conext ComBox. However, for first-time setup, it is not recommended. The Conext ComBox clock will override the other Xanbus devices’ clocks and could trigger unintentional time-based events.

DO NOT connect the Conext ComBox to the Xanbus network before setting up the internal clock of the Conext ComBox. If Xanbus is the only power source to the ComBox, after installation verify the time settings in all devices.

When you connect the Conext ComBox to the network, the web application automatically discovers any new Xanbus devices, and Modbus addresses are assigned according to the starting address configuration settings. Log out of the web user interface and then log in again to check the Modbus address for the new device and its status.

When applying power to the Conext ComBox through the Xanbus network, make sure the Xanbus network itself has power. Only Freedom SW inverter/chargers can provide power to the Xanbus network and must be operating.

Note:

- Xanbus components can be arranged in any order.
 - Use a network terminator at both ends of the Xanbus network.
-

To connect the Conext ComBox to an existing Xanbus network:

The assumption at this point is that there is an existing Xanbus network and all Xanbus-enabled devices in that network have been previously interconnected with each other.

1. Put the Freedom SW inverter/chargers and Xanbus AGS into standby mode before connecting the Conext ComBox to avoid triggering any unintentional time-based events.

You can put the inverter/chargers out of standby mode later when you have completed configuration of the Conext ComBox.

2. Using the sample illustration below, connect the Conext ComBox to the Xanbus network.

<i>NOTICE</i>
EQUIPMENT DAMAGE Do not connect a Xanbus RJ-45 cable plug into the 10/100 Ethernet port of the Conext ComBox. Failure to follow these instructions can damage equipment or affect network performance.

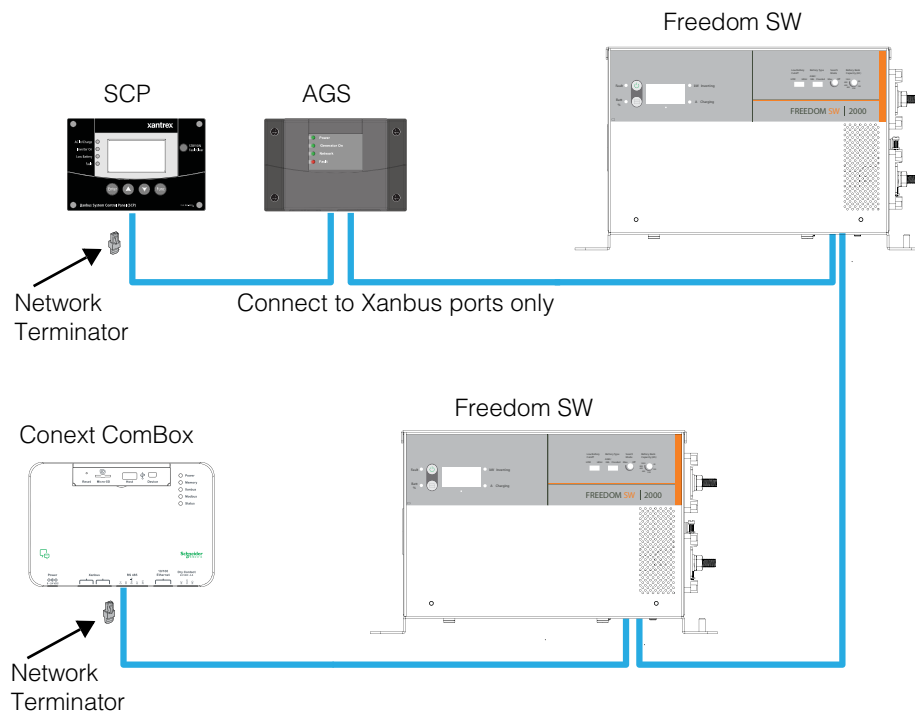

Be sure to terminate the Xanbus network with Xanbus network terminators at both ends.

When the Conext ComBox starts communicating with other Xanbus-enabled devices on the network, the Xanbus LED will go on.

The Conext ComBox is now ready to configure, control, and monitor the devices connected on the Xanbus network.

Changing Basic Conext ComBox Settings

To configure basic settings for one or more Freedom SW products, click on the Home screen to display the control panel.



Note: The Freedom SW has one AC input. Your ComBox will be configured to display GRID or GENERATOR power flow (but not both at the same time).

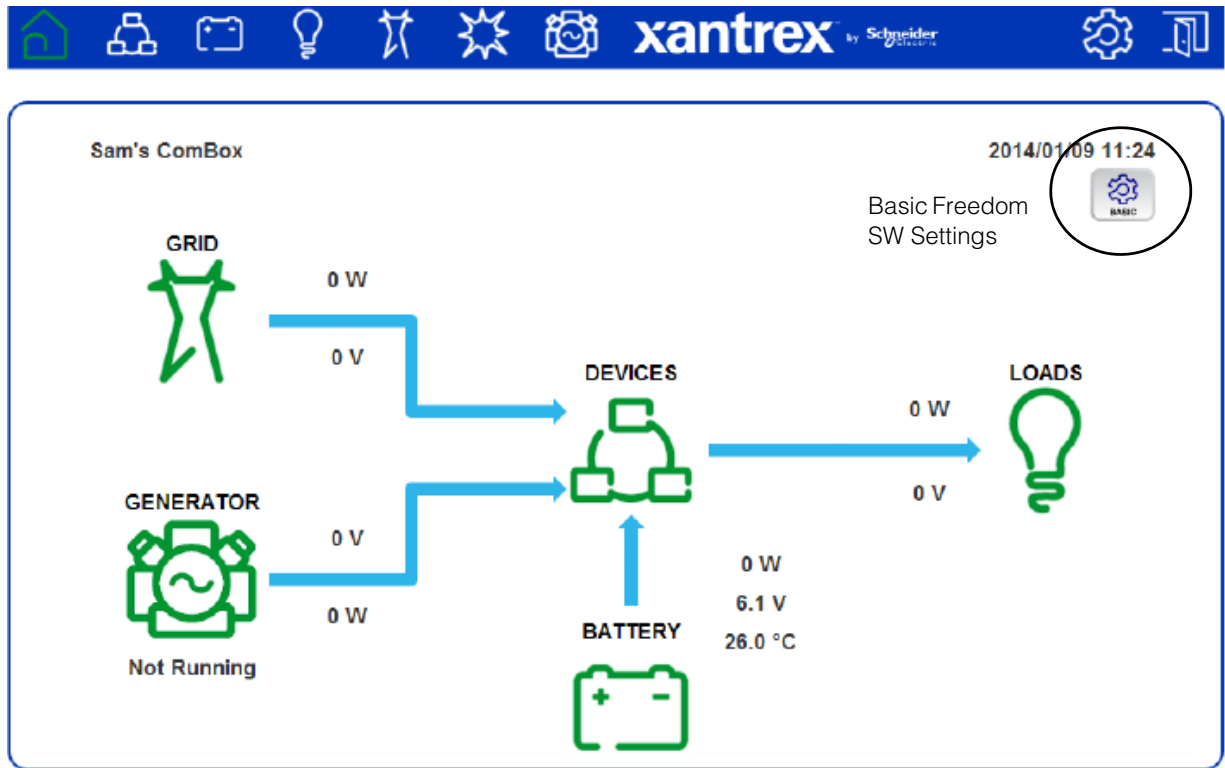

Control Panel

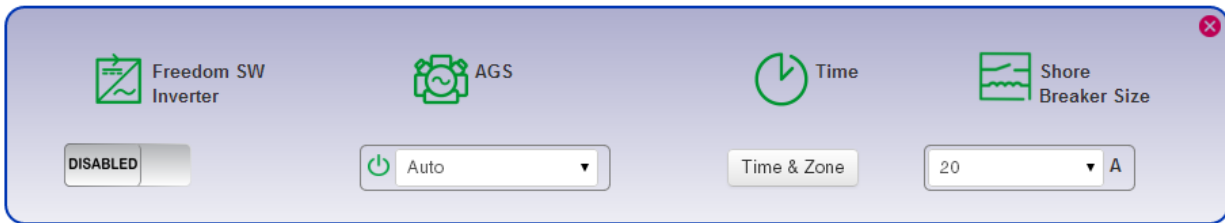

In the control panel, adjust the following settings as needed, and click the close button when done.

	<p>Select Enable to turn on the inverter. When the inverter is on, any AC loads connected to it receive power. Select Disable to turn off the inverter.</p> <p>If there are two inverter/chargers in the system, this setting applies to both devices.</p>
	<p>Select Auto to automatically start or stop the generator based on the settings selected in the Xanbus AGS. These settings include triggers for low battery voltage, AC loads on the inverter, thermostat triggers and exercise time.</p> <p>Select Manual On to override the automatic start settings and start the generator. The generator will run until manually stopped (Manual Off) or when it reaches the Maximum Run Time setting defined in the AGS.</p> <p>Select Manual Off to override the automatic stop settings and stop the generator when it has been started manually (Manual On).</p> <p>For information on AGS settings see the <i>Xanbus Automatic Generator Start Owner's Guide</i>.</p>
	<p>Select the appropriate time and time zone from the list to synchronize the ComBox and Xanbus SCP internal clocks.</p> <p>It is important for devices on the Xanbus network to have the same system time. If the internal clocks are not synchronized, timing-reliant devices such as the AGS could start or stop unintentionally.</p> <p>Note: This setting also sets the time and zone value in the Settings screen. See “Changing Advanced Conext ComBox Settings” on page 3–15.</p>

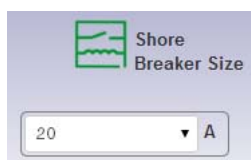

Set the amperage limit for the AC shore breaker using the drop down list.



If the system has both a Freedom Sequence power management system and a Freedom SW inverter/charger installed, this setting applies to both devices. If the system does not have a Freedom Sequence, then only the Freedom SW inverter/charger shore breaker size is set.

When input current exceeds the selected value, the Freedom SW inverter/charger reduces its charge current to limit the total power to 80% of this setting, and the Freedom Sequence progressively sheds low priority loads to avoid unnecessary tripping of the AC shore breaker.

Changing Advanced Conext ComBox Settings



The section describes how to configure the advanced Conext ComBox parameters. To access these settings, you must be logged in as Admin.

To access all Conext ComBox settings:

1. Log in as Admin, and in the menu bar, click .
2. Click  **Setup** in the left side menu.

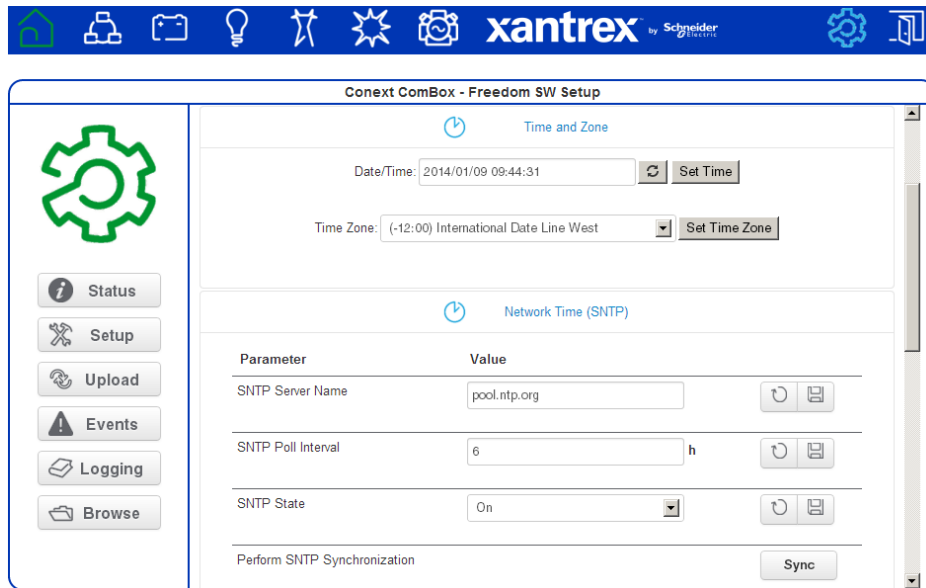
You will see a screen similar to the one shown below.



3. Click the setting type you want to change.
That portion of the window expands to display the change options for that setting. The size and content of the expanded window varies depending on the setting type.
4. In the expanded window, click  to see the current setting. This may be different from the value shown if the change was made in another way.
5. Modify the value(s) as necessary.
6. Click  to save the change(s).



General Settings



Changing the device name

The default **Device Friendly Name** is the device's serial number assigned at the factory. It is good practice to change this default to a user-friendly name.

To change the device name:

1. Replace the default value using alphanumeric characters.
2. Click  to save the setting.
3. To recall the previous value, click .

Rebooting the Conext ComBox

You can reboot the Conext ComBox unit from the web user interface without doing a power cycle. This type of “soft” rebooting is oftentimes necessary when certain settings are changed, like changing the Xanbus Bit Rate parameter.

To reboot the Conext ComBox:

1. Click the  button. A Warning dialog box appears.
2. Click the OK button on the Warning dialog box.
3. To discontinue rebooting, click the Cancel button on the Warning dialog box.

Shutting down the Conext ComBox

You should shut down the Conext ComBox unit from the web user interface. Shutting down is equivalent to turning off the unit, usually for preparing to store the unit away or to reinstall the unit at a different location.

Note: Do not shut down by abruptly disconnecting all power sources to the Conext ComBox without following the procedure below. An abrupt disconnection may result in data corruption.

To shut down the Conext ComBox:

1. Click the  button. A Warning dialog box appears.
2. Click the OK button on the Warning dialog box.
3. To discontinue shutting down, click the Cancel button on the Warning dialog box.

Change User Password Settings

The Change User Password setting applies only to the Conext ComBox user account.

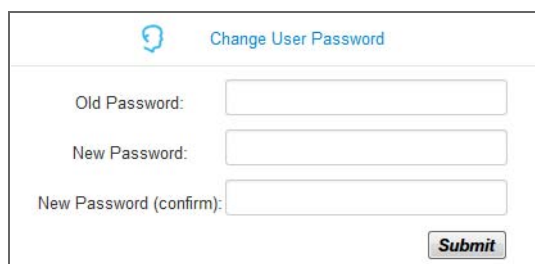

The screenshot shows a web form titled "Change User Password" with a blue header and a lock icon. It contains three input fields: "Old Password:", "New Password:", and "New Password (confirm):". A "Submit" button is located at the bottom right of the form.

To change the user password:













1. Enter the **Old Password**.
2. Enter your **New Password**.
The password should contain at least eight alphanumeric (0-9, a-z, A-Z) characters with no special characters and spaces. Passwords are case-sensitive and the maximum length is 32 characters.
3. Enter the **New Password (confirm)** again.
4. Click **Submit**.
A message indicates that the password change was successful.

Change Admin Password Settings

The Change Admin Password setting applies only to the Conext ComBox admin account.

See “Changing the Admin Password” on page 3–5.

TCP/IP Settings

 TCP/IP Settings	
Parameter	Value
TCP/IP Address	<input type="text" value="10.167.76.67"/>  
TCP/IP Net Mask	<input type="text" value="255.255.255.0"/>  
Gateway Address	<input type="text" value="10.167.76.1"/>  
DNS Server Address	<input type="text" value="10.167.77.80"/>  
Device Name	<input type="text" value="cb-1004-0035"/>  
Use DHCP	<input type="text" value="Yes"/>  

By default, the Use DHCP parameter is set to **Yes**. By enabling DHCP, the four parameters (TCP/IP Address, TCP/IP Net Mask, Gateway Address, and DNS Server Address) are filled automatically. If the Use DHCP parameter is set to **No**, you have to manually fill the four parameters with static IP addresses.

Note: Only a qualified IT professional should perform changes to TCP/IP related settings.

E-mail Settings

See “Changing E-Mail Settings” on page 3–9.

Note: E-mail Settings is a networking feature that requires a Local Area Network with Internet access. If you do not have Internet access through your router, this feature is not available.

E-mail Reporting





Note: E-mail Reporting is a networking feature that requires a Local Area Network with Internet access. If you do not have Internet access through your router, this feature is not available.

 E-Mail Reporting	
Parameter	Value
Email System Report	No <input type="button" value="↺"/> <input type="button" value="💾"/>
System Report: Generator Energy	Included <input type="button" value="↺"/> <input type="button" value="💾"/>
System Report: Load Energy	Included <input type="button" value="↺"/> <input type="button" value="💾"/>
System Report: Sold To Grid	Included <input type="button" value="↺"/> <input type="button" value="💾"/>
System Report: Used From Grid	Included <input type="button" value="↺"/> <input type="button" value="💾"/>
System Report: PV Harvest	Included <input type="button" value="↺"/> <input type="button" value="💾"/>
System Report: Used From Battery	Not Included <input type="button" value="↺"/> <input type="button" value="💾"/>
System Report: Stored In Battery	Not Included <input type="button" value="↺"/> <input type="button" value="💾"/>
Email Device Report	No <input type="button" value="↺"/> <input type="button" value="💾"/>
Email Report Frequency	Daily Report <input type="button" value="↺"/> <input type="button" value="💾"/>
Email Report Day (For Weekly Mail)	Sunday <input type="button" value="↺"/> <input type="button" value="💾"/>
Email Report Day (For Monthly Mail)	Last Day of the Month <input type="button" value="↺"/> <input type="button" value="💾"/>
Send Test Report	<input type="button" value="Send"/>

E-mail System Report	<p>Activate or deactivate system reporting features. When activated (Yes), system reports are sent electronically to recipients listed in E-Mail Recipients under E-mail Settings.</p>
System Report	<p>Include (Included) or exclude (Not Included) certain categories in the system reports that are being sent. The system reports are broken down into different categories such as Generator Energy, Load Energy, etc.</p>
E-mail Device Report	<p>Activate or deactivate device-specific reporting features. When activated (Yes), device reports are sent electronically to recipients listed in E-Mail Recipients under E-mail Settings.</p>
E-mail Report Frequency	<p>Change the frequency of reporting by day, week, or month.</p>
E-mail Report Day	<p>For weekly reporting, choose a day of the week to receive system reports.</p> <p>For monthly reporting, choose whether to receive system reports at the last day of each month or any particular day of the month.</p>
Send Test Report	<p>Test that the E-mail Settings in “Changing E-Mail Settings” on page 3–9 have been configured correctly.</p> <p>Press the  button to send a sample e-mail message to the addresses listed in the E-mail Recipients parameter.</p>

Web

Note: Web is a networking feature that requires a Local Area Network with Internet access. If you do not have Internet access through your router, this feature is not available.

Web	
Parameter	Value
Web Server Access	<input type="text" value="HTTP"/>   
Web Server Port	<input type="text" value="80"/>  

If you want Web access to the Conext ComBox:

- In **Web Server Access**, select **HTTP** and then click .

If you do not want Web access to the Conext ComBox:

- In **Web Server Access**, select **Disabled** and then click .

The default value of the **Web Server Port** is **80**. If this value is changed to **8080**, you must append the URL address with “:8080” at the end of the IP address.







Note: You must restart ComBox after changing the **Web Server Port**.

Note: If the Web server is disabled (for example, for security reasons), the Web server will not be available on the next reboot of the Conext ComBox. To regain access to the Web server, “Resetting the Conext ComBox to Factory Settings” is necessary to make configuration changes.

FTP

Note: FTP is a networking feature that requires a Local Area Network with Internet access. If you do not have Internet access through your router, this feature is not available.

This setting is for advanced users only.

Parameter	Value	
FTP User 1 Name	<input type="text" value="firmware"/>	 
FTP User 1 Password	<input type="text" value=""/> <input type="text" value=""/>	(New) (Confirm)  
FTP User 2 Name	<input type="text" value="logs"/>	 
FTP User 2 Password	<input type="text" value=""/> <input type="text" value=""/>	(New) (Confirm)  

Use for updating firmware

The **FTP User 1 Name** and **FTP User 1 Password** are used for firmware upgrades. By default, the password is the same as the user name so it must be changed.

For upgrades go to:

- <http://xantrex.com/power-products/default/conext-combox-freedomsw>

Use for downloading logs

The **FTP User 2 Name** and **FTP User 2 Password** are used to download log information. By default, the password is the same as the user name so it must be changed.

FTP Logger

Note: FTP Logger is a networking feature that requires a Local Area Network with Internet access. If you do not have Internet access through your router, this feature is not available.

This setting allows the user to push event and detected fault logs to an FTP site.

Parameter	Value
FTP Log Enable	Disable
FTP Log Destination Address	
FTP Log Username	
FTP Log Password	(New) (Confirm)
FTP Log Destination Directory	pub\
Test FTP logging	Log

FTP Log Enable	Activate or deactivate FTP logging features. When activated (Enable), FTP logs are sent electronically to an FTP site.
FTP Log Destination Address	Specify a valid FTP site.
FTP Log Username	Specify the FTP site's valid user name.
FTP Log Password	Specify the FTP site's valid password in the (New) field. Repeat the password in the (Confirm) field.
FTP Log Destination Directory	Specify a valid directory on the FTP site where all the logs will be stored.
Test FTP Logging	<p>Test that the FTP Logger settings have been configured correctly.</p> <p>Press the  button to send a sample log to the FTP site specified in FTP Log Destination Address.</p>

Dry Contact Relay

You can set the **Relay Mode of Operation** to **Automatic** so that the relay will automatically go on if a fault is detected in the system.

Parameter	Value
Relay Mode Of Operation	Automatic

To manually control the mode of operation so that the relay is always on (or off), select **On** (or **Off**).

Suppress Device Faults/Warnings

You can suppress certain fault and warning codes from being included in the device reports that are sent to **E-Mail Recipients** specified in **E-Mail Settings**.

Parameter	Value
Suppress SCP Faults/Warnings	<input type="text"/>
Suppress AGS Faults/Warnings	<input type="text"/>
Suppress FSW Faults/Warnings	<input type="text"/>
Suppress MPPT Faults/Warnings	<input type="text"/>

List the fault and warning codes for each device you want to exclude in the report by entering the name of the code. Separate multiple codes by comma.

The fault and warning codes for all the devices are usually listed under the Troubleshooting section of the device's Owner's Guide.

Xanbus Communications

↻ Xanbus Communications	
Parameter	Value
Xanbus Bit Rate	250 Kbps ↻ ⌨

The **Xanbus Bit Rate** parameter for the Conext ComBox has two possible values: 125 and 250 Kbps. The default value for the **Xanbus Bit Rate** is 250 Kbps. When this setting is changed, reboot the Conext ComBox for the new setting to take effect. See “Rebooting the Conext ComBox” on page 3–17.

Freedom SW devices and components require a 250 Kbps bit rate. You cannot change the bit rate for Freedom SW system devices and components.

Modbus Communications

Note: Modbus support is available only for the Conext ComBox (Part Number 865-1058), and Conext Modbus Converter (Part Number 865-1059), used with Schneider Electric Conext series inverter products.

The Modbus Communications option available with this Conext ComBox – Freedom SW (Part Number 809- 0918), is not required for operation or supported by Xantrex technical support.

↻ Modbus Communications	
Parameter	Value
RS-485 Baud Rate	19200 ↻ ⌨
RS-485 Parity	E ↻ ⌨
RS-485 Stop Bits	1 ↻ ⌨
Modbus TCP Enabled	Listening ↻ ⌨
Modbus TCP Port	502 ↻ ⌨
Modbus Address	201 ↻ ⌨
Modbus Byte Order	LSB First ↻ ⌨

All of the RS 485 and Modbus settings for the Conext ComBox can be changed as necessary. The default value for the **Modbus TCP Port** is 502 and the **Server Modbus Address** is 201.

Select **Listening in Modbus TCP Enabled** to enable Modbus communication.

Note:

When writing a character string using function code 0x10 (Write Multiple Registers), the NUL terminator **MUST** be written or the string will not be stored.

When writing 32-bit modbus registers, both 16-bit registers which make up the 32-bit value must be written in order to store the data.

Modbus Byte Order

You can configure the Conext ComBox to change the Modbus byte and word ordering for packed ASCII strings, and 32-bit values. There are two settings for **Modbus Byte Order**:

1. Least Significant byte/word first (**LSB First**)
2. Most Significant byte/word first (**MSB First**)

Select the appropriate setting for your Modbus network.

The following are examples of how the settings operate.

Packed String Example:

When sending the text string "CONEXT" over Modbus:

1. Least Significant byte:



2. Most Significant byte:



32-bit Word Example:

When sending the value 0x12345678 over modbus:

1. Least Significant word:

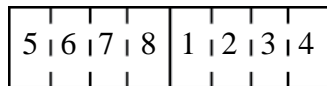

2. Most Significant word:

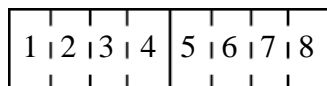

Modbus Address List

Note: Modbus support is available only for the Conext ComBox (Part Number 865-1058), and Conext Modbus Converter (Part Number 865-1059), used with Schneider Electric Conext series inverter products.

The Modbus Address List option available with this Conext ComBox – Freedom SW (Part Number 809-0918), is not required for operation or supported by Xantrex technical support.

Use this function to change the Modbus address of a device. The Conext ComBox automatically assigns addresses when it is installed, but individual values can be changed as necessary. The default addresses are assigned per device type.

Note: To change the initial starting address settings, see “Modbus Address Enumeration”.

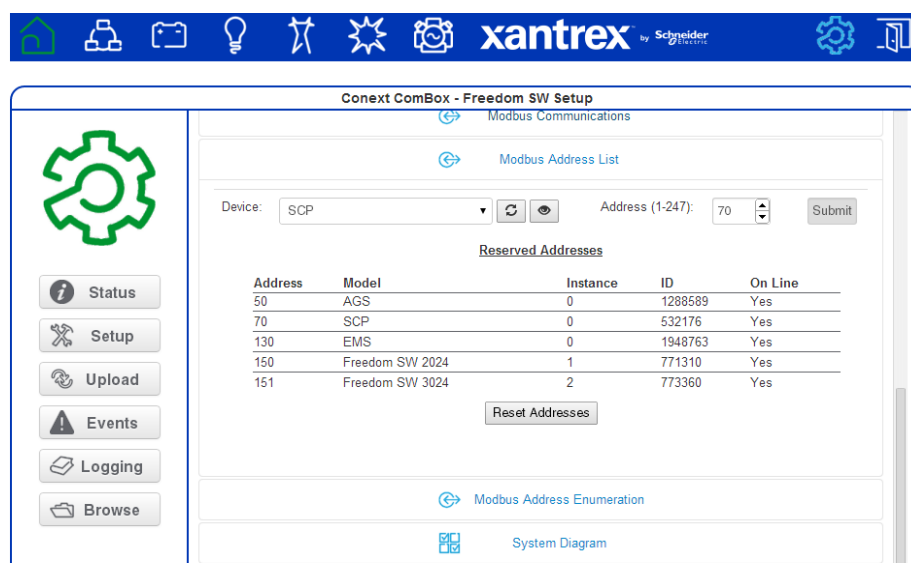

To change a device Modbus address:

1. In **Setup**, click **Modbus Address List**.

The expanded window displays a table of addresses that are already reserved along with the associated device, its **ID** and **On Line** status.

Note: Valid Modbus addresses are listed from 1 to 247. The rest are assigned special meanings.

2. To change a device Modbus address:

- Select the **Device** from the drop-down list.
Its address is displayed in the address box.

If you want to make sure you have selected the correct device:

Click  and a physical indicator on the device will flash, light up, or beep depending on the device.

- Click  to make sure you view the latest information.
- Enter the new address for the device in the address box. Do not use an address that is already reserved.
- Click **Submit** to save the address change.















To reset all of the device Modbus addresses to their default values:

- ◆ In Modbus Address List, click **Reset Addresses**.

Modbus Address Enumeration

Note: Modbus support is available only for the Conext ComBox (Part Number 865-1058), and Conext Modbus Converter (Part Number 865-1059), used with Schneider Electric Conext series inverter products.

The Modbus Address Enumeration option available with this Conext ComBox – Freedom SW (Part Number 809-0918), is not required for operation or supported by Xantrex technical support.

↻ Modbus Address Enumeration		
Parameter	Value	
XW Modbus Start Address	<input type="text" value="10"/>	 
MPPT Modbus Start Address	<input type="text" value="30"/>	 
AGS Modbus Start Address	<input type="text" value="50"/>	 
SCP Modbus Start Address	<input type="text" value="70"/>	 
CSW Modbus Start Address	<input type="text" value="90"/>	 
Grid-Tie Modbus Start Address	<input type="text" value="110"/>	 
HVMPPT Modbus Start Address	<input type="text" value="170"/>	 

Use this setting to change the initial starting Modbus addresses for device types. The Conext ComBox automatically assigns starting addresses when it is installed but the starting values can be changed as you wish.



Make these changes before connecting new devices to the Conext ComBox system. When the Conext ComBox detects a new device, it will assign the address based on the current start address setting for that device type.

For example, a Freedom SW Modbus Start Address of 10:

- The first Freedom SW discovered on the network will be assigned the address 10.
- The second Freedom SW discovered on the network will be assigned the address 11, and so on.

The starting addresses for each device type on installation of the Conext ComBox are listed above.

To change device type starting addresses:

1. In **Modbus Device Address Enumeration**, click  for the device type to ensure you have the current information.
2. Enter the new starting value for the device type and click .

Note: Valid Modbus addresses can be from 1 to 247. The rest of the numbers are assigned special meanings.

3. Once you have saved all device type starting addresses, there are two options:
 - You can keep the existing device addresses, and the new start address will be applied only to newly discovered devices.

When a new device is detected, the Conext ComBox determines the starting address of that device type, finds the first unused address for that device type, and assigns this address to the new device











- The Conext ComBox can perform a device rediscovery to reassign addresses based on the changed starting addresses.

To reassign new addresses to all devices:

In **Modbus Address List**, click **Reset Addresses**. Then, perform a reboot (see “Rebooting the Conext ComBox” on page 3–17).

System Diagram

Use this setting to include (checked box) or exclude (unchecked box) system diagrams of each electrical system component as displayed in the Home screen.

Parameter	Value	
Show System Diagram Grid	<input checked="" type="checkbox"/>	 
Show System Diagram Battery	<input checked="" type="checkbox"/>	 
Show System Diagram Generator	<input checked="" type="checkbox"/>	 
Show System Diagram PV	<input type="checkbox"/>	 
Show System Diagram Load	<input checked="" type="checkbox"/>	 

Resetting the Conext ComBox to Factory Settings

If you need to return the Conext ComBox to all of the original factory settings, you can perform a reset.

To reset the Conext ComBox to original factory settings:

1. Turn off the Conext ComBox by shutting it down properly (as shown on page 3–17) and then disconnecting all its power sources. Make sure the Power LED is off. Wait ten seconds before the next step.

To turn the unit on, insert a pointed object such as a paper clip into the Reset pinhole, and press the button while reconnecting the Conext ComBox's power source.

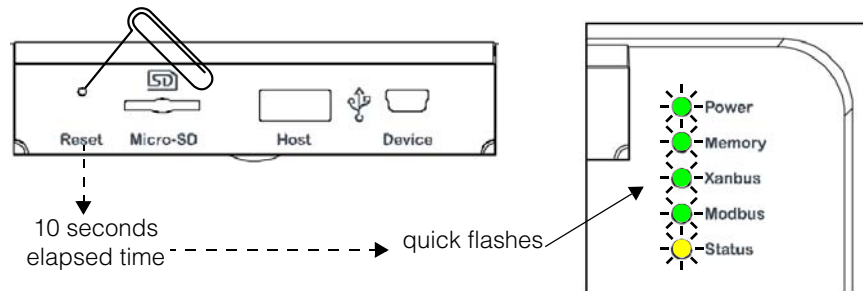

2. Continue pressing (holding) the Reset pinhole button until all indicator LEDs flash quickly five times (approximately 10 seconds) and then quickly release the button.

Important: Do not hold the reset button too long after observing the quick flashes. When you observe that the indicator LEDs have begun flashing slowly, the internal firmware memory will have already been cleared. There is no way to undo this except to do an upgrade. See “Upgrading Firmware” on page 3–35.

Note: The Power LED flashes slowly during the Conext ComBox application loading and flashes quickly during application initialization. The other LEDs go on as the startup progresses. This process takes about two minutes.

3. When the reset is complete, the Power indicator is on to indicate the Conext ComBox is ready.

Changing Device Settings

The Conext ComBox allows you to configure settings on the Freedom SW, Xanbus SCP and Xanbus AGS.

Before making any changes, familiarise yourself thoroughly with the effects of changing the power system settings.

NOTICE

EQUIPMENT DAMAGE

- Consult the device’s Owner’s Guide when changing the device’s settings.
- Make sure the device connected on the Xanbus or Modbus network is in standby mode before changing settings.
- Do not change any settings unless you are familiar with the device.

Failure to follow these instructions can damage equipment.

To set a device in Standby mode:

1. Click the  Devices icon to show all Xanbus devices in the network.
2. Select the device type from the Devices screen.

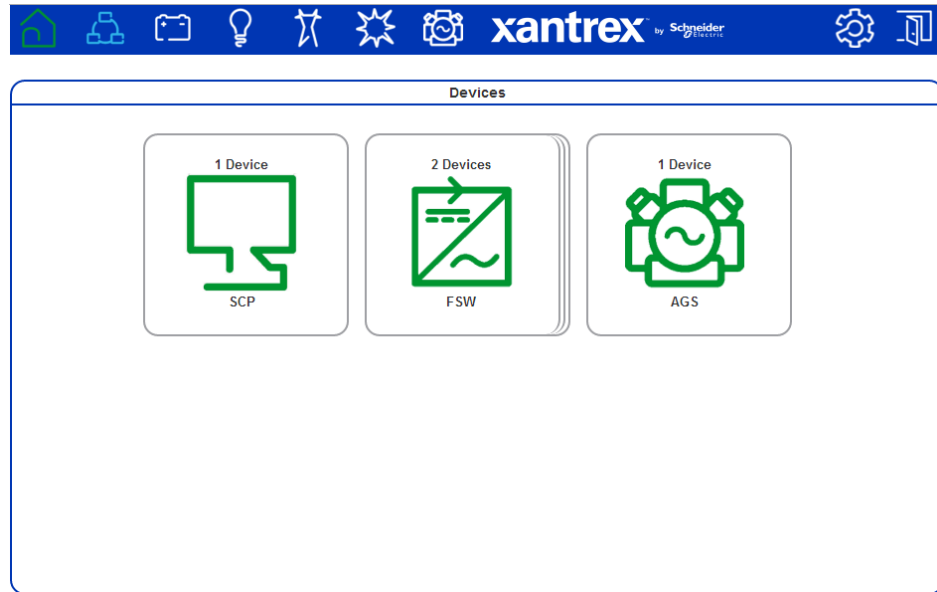



3. Click the device you want to change from the Devices screen above.
The Device Summary Table screen opens. If there are more than one of the same device type, the devices will be listed in the summary table.

The screenshot shows the 'FSW Device Summary Table' with the following data:

Name	Config.	Grid [W]	Load [W]	Grid [V]	Grid [Hz]	Batt [V]	Batt [A]	Batt [°C]
FSW2024 (0)	Slave	0	0	0.0	0.0	5.4	0.0	27.0
FSW3012 (1)	Master	0	0	0.0	0.0	5.5	0.0	N/A
		Σ 0	Σ 0				Σ 0.0	

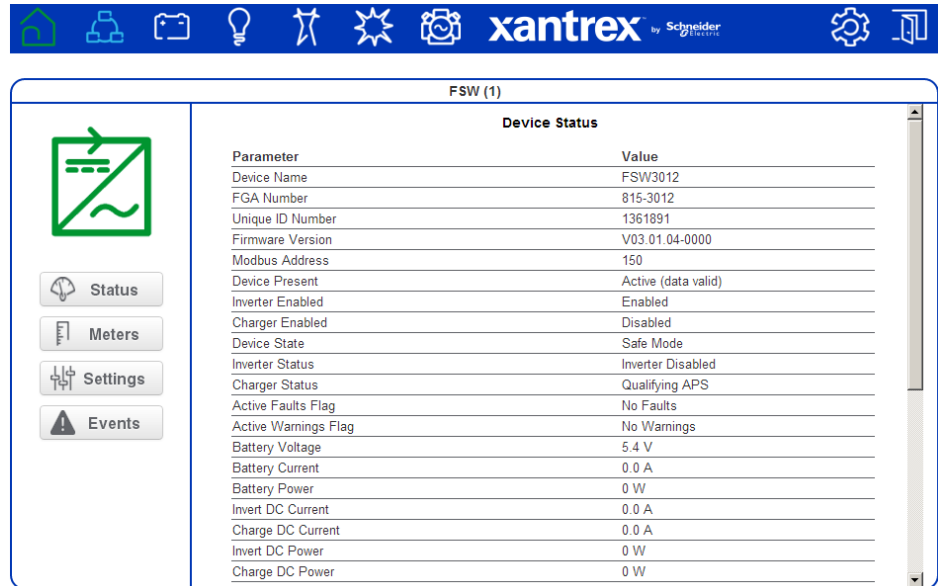
4. Click the Freedom SW, SCP, or AGS you want to change from the summary table. The Device Status screen opens.



5. Click  **Settings** in the left side menu.
6. You will see a list of **Device Settings** for that type of device.
7. Click  **Controls** to expand the Controls setting.
8. Change the Operating Mode parameter to Standby.





9. Click  to save the setting.

To change a Device Setting after putting the device on Standby:

1. After putting a device on Standby mode, proceed to change the device's other settings.

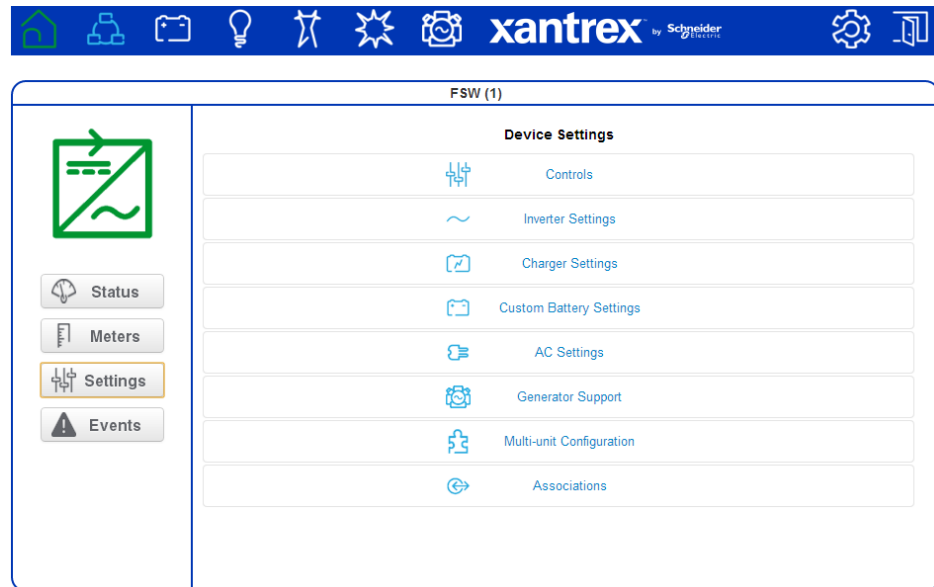
Important: Device settings for each Xanbus device vary. Be sure to consult the device's Owner's Guide before trying to change the settings via the Conext ComBox.



2. Click the Device Setting type you want to change.
That portion of the window will expand to display the change options for that setting.
3. In the expanded window, click  to see the current setting. This may be different from the value shown, if the change was made in another way – for example, another device like the SCP was used to change the value.
4. Modify the value(s) as necessary.
5. Click  to save the change(s).

Using Cascading Parameters

Xanbus-enabled devices are typically configured one at a time. However, because devices often have common settings, cascading parameters can simplify and speed up system configuration. When a parameter is “cascaded,” a newly configured device setting on one device is applied to all devices of the same device type on a common AC or DC connection.

For example, if cascading parameters are enabled and a Battery Size (Ah) parameter is changed on the Freedom SW inverter setup menu, the same battery size setting is applied to the second inverter.

To enable or disable cascading parameters:

1. Put the device on standby mode. See “To set a device in Standby mode:” on page 3–31.
2. Click  to access the individual devices menu.

3. Click the device you want to configure.
4. Click  **Settings** in the left side menu to see a list of **Device Settings** for that type of device.

Important: Device settings for each Xanbus device vary. Consult the device Owner's Guide before trying to change the settings via the Conext ComBox.

Also, when configuring the network-managed power system with cascading parameters enabled, you should verify that the configurations have been cascaded correctly to other devices. Communication errors may cause parameters to revert to their original values or generate a warning message.

5. Click  **Multi-unit Configuration** to expand the device setting.

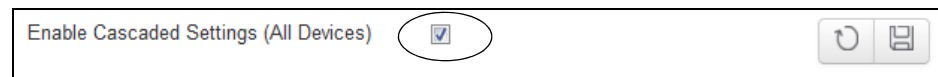

6. Click the check box to enable the setting. If the box is already checked then cascading is already set up and no further action is necessary.
7. Click  to save the change.

Upgrading Firmware

You can perform firmware upgrades for your Conext ComBox and Xanbus-enabled devices when they are available for download. You can download them to a USB thumb drive, or to a laptop that you then connect to the Conext ComBox.

Firmware upgrades are available at:

- <http://xantrex.com/power-products/default/conext-combox-freedomsw>

Note: It is recommended you clear the internal firmware memory of the Conext ComBox before installing firmware upgrades.

Clearing the Internal Firmware Memory

Note: Clearing internal firmware memory should be done for Conext ComBox upgrades only. It is not necessary for upgrades to other devices on the network.

To clear the Conext ComBox internal firmware memory:

1. Turn off the Conext ComBox by shutting it down and disconnecting all its power sources. Make sure the Power LED is off. Wait ten seconds before the next step.
2. Insert a pointed object such as a paper clip into the Reset pinhole and press the button while turning on the Conext ComBox by reconnecting to its power source.

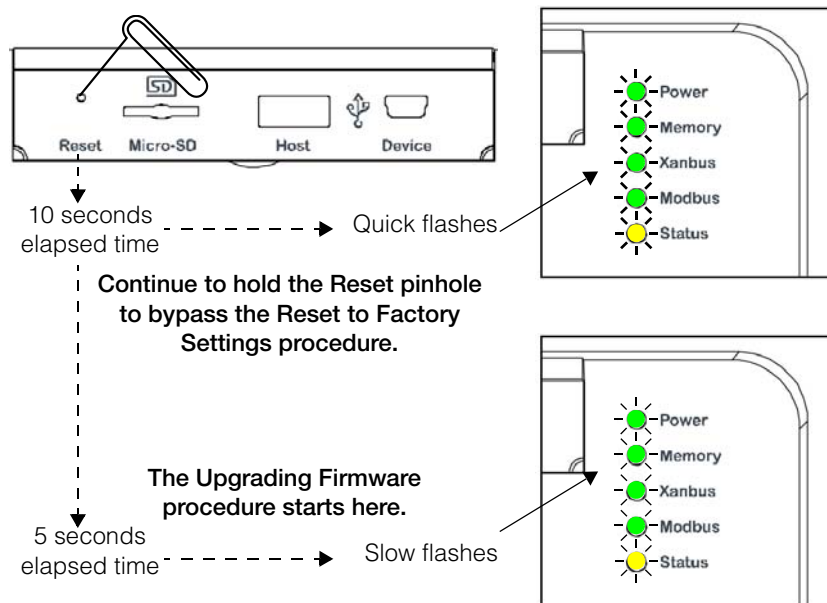

3. Continue holding the Reset pinhole button until all indicator LEDs flash quickly five times (approximately 10 seconds). Continue to hold the button until the LEDs flash slowly (approximately 5 seconds). When the memory has been cleared, the Status and Power LEDs are on and a firmware upgrade must be done.

Installing Conext ComBox Upgrades from a Thumb Drive

To install an upgrade for the Conext ComBox using a thumb drive:

1. Connect the thumb drive to a computer with Internet access.
There must be only one **.bdl** file on the thumb drive. If there are two or more **.bdl** files, there is no guarantee which **.bdl** file will be chosen.
2. In a web browser, go to the following website to select the upgrade you need:
<http://xantrex.com/power-products/default/conext-combox-freedomsw>
3. Once you have found the upgrade, save the **.bdl** file to the root directory of the thumb drive.

Note: Save the **.bdl** file to the root directory of the thumb drive so the upgrade can install properly.

4. Clear the Conext ComBox internal memory. See “Clearing the Internal Firmware Memory”.
Connect the thumb drive to the USB port labeled Host on the top front of the Conext ComBox.

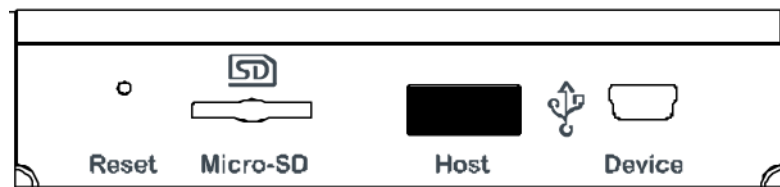

The firmware upgrade begins automatically.

5. Watch the indicator LEDs on the Conext ComBox. When the Xanbus LED goes on, it is now okay to remove the thumb drive.
As the upgrade progresses the Power LED flashes. The other LEDs go on to indicate the upgrade process. This can take several minutes depending on the size of the upgrade.
6. When the upgrade is complete, the Power LED is on to indicate that the Conext ComBox is ready.
7. Clear your computer's web browser cache after the upgrade before you log back in to the Conext ComBox's web user interface.

Clearing a web browser's cache

To clear the web browser's cache:

1. In PC-based web browsers, press the keyboard shortcut



2. In the dialog box that opens (varies for each web browser), select an option to clear temporary Internet files or “cache”.

3. For Mac's Safari web browser, go to Preferences and then to Security.

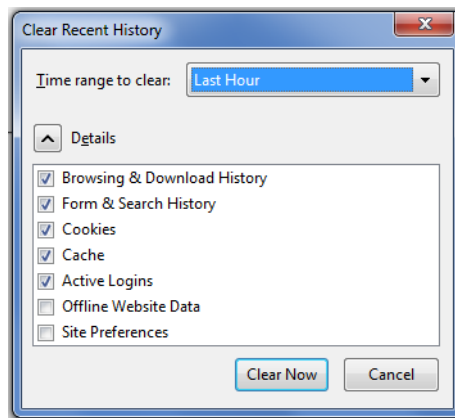
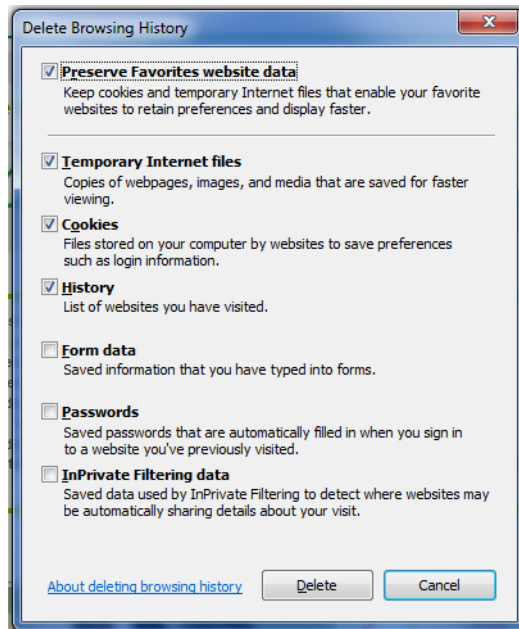

Installing Conext ComBox Upgrades Remotely

Note: Internet Explorer 8.0 and 9.0 do not support firmware upgrades. Use Chrome 18.x or later, IE 10.x or later, Firefox 12 or later, or Safari 5.x or later for Conext ComBox upgrades.

To install a Conext ComBox upgrade remotely:

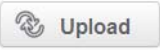
1. In a web browser, go to the following website to select the Conext ComBox upgrade you need:
<http://xantrex.com/power-products/default/conext-combox-freedomsw>
2. After you find the upgrade, save the .bdl file in a local directory.
3. In your web browser, connect to your Conext ComBox.
4. Log in to the Conext ComBox web user interface with your user name and password.
5. Click  in the menu bar.
6. Click  in the left side menu.
7. In File under File Uploads to Conext ComBox, click the field box to select the .bdl file (*factory.bdl*) you saved in a local directory from the Xantrex website.

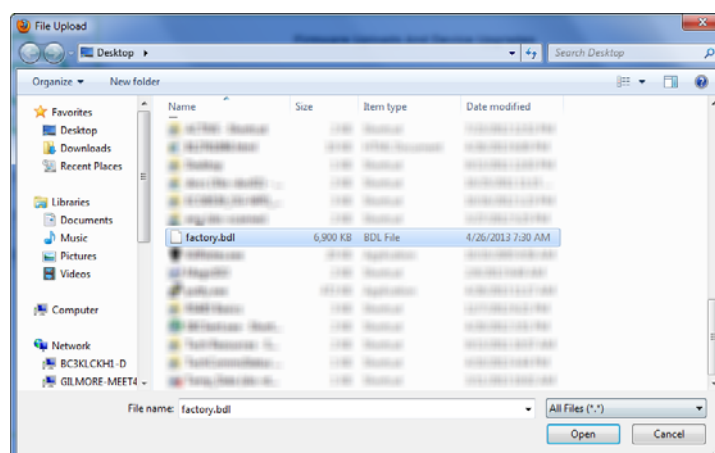
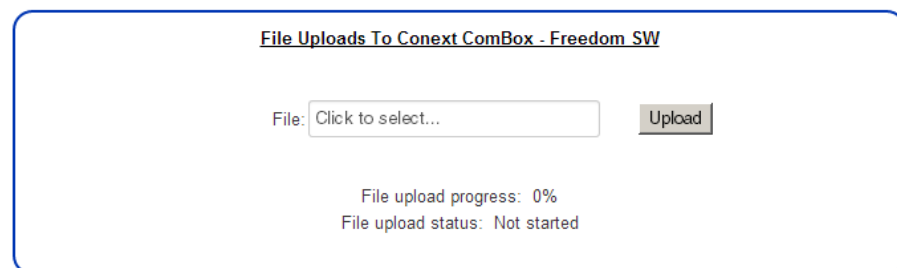

8. Click **Upload**, and then **OK** in the warning dialog box.
As the bundle is transferred to the Conext ComBox, progress is indicated in percentage, and a message screen indicates when the file transfer has been completed successfully.
When the bundle file has transferred to the Conext ComBox, the files in the bundle are automatically extracted and reprogramming of the Conext ComBox begins.
9. Clear your web browser cache before you log back in to the Conext ComBox's web user interface. See "Clearing a web browser's cache" on page 3-37.
10. Reboot the Conext ComBox. See "Rebooting the Conext ComBox" on page 3-17.

Bootloader Upgrade

What happens when a new bootloader is included in the upgrade file?

It is possible that the bundle file may also contain a bootloader upgrade file. To find out, you need to log back in and follow these instructions.

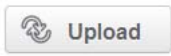
1. In your web browser, connect to your Conext ComBox.
2. Log in to the Conext ComBox web user interface with your user name and password.
3. Click  in the menu bar.
4. Click  in the left side menu. If a new bootloader is included in the bundle file, you are automatically prompted to update the Conext ComBox bootloader.

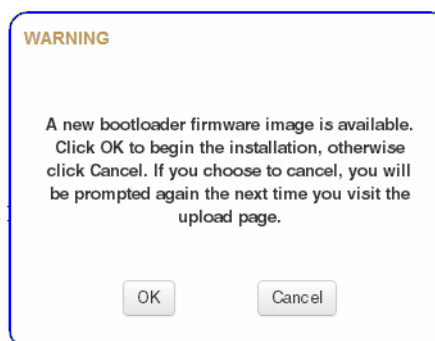



5. Click **OK**, and wait while the bootloader upgrade progress completes. The Conext ComBox restarts automatically when the upgrade is finished.
6. Clear your web browser cache before you log back in to the Conext ComBox's web user interface. See "Clearing a web browser's cache" on page 3-37.

Installing Xanbus Device Upgrades

You can upgrade firmware for specific Xanbus-enabled devices remotely or from a computer connected to the Conext ComBox with the USB cable supplied.

Note: Your Web browser may not support the upgrade function. Use Chrome 18.x or later, IE 10.x or later, Firefox 12 or later, or Safari 5.x or later for Conext ComBox upgrades.

To install upgrades for Xanbus devices connected to the Conext ComBox:

1. In a Web browser, go to <http://www.xantrex.com> to select the device upgrade that you need.
2. Once you have found the upgrade, save the .xf0 file in a local directory.
3. In your Web browser, connect to the Conext ComBox.
4. Log in to the Conext ComBox web user interface with your user name and password.
5. Click  in the menu bar.
6. Click  in the left side menu.
7. In **File** under **File Uploads to Conext ComBox**, click to select the .bdl file you saved from the Xantrex website.
8. Once the file is successfully transferred to the Conext ComBox, go to the **Xanbus Device Upgrades** section.

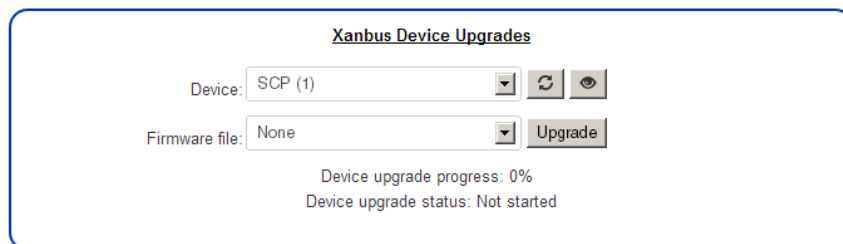

9. In **Device**, click  to load the latest list of devices.
10. Select the **Device** you want to upgrade from the drop-down list.

You can click  to confirm you have selected the device you want. When you click the icon, some type of visual and/or audio indicators on the selected device will flash.

11. In **Firmware file**, select the .xf0 file for the device upgrade.
12. Click **Upgrade**.

Device upgrade progress is indicated in percent and **Device upgrade status** is **OK** when the upgrade has completed successfully.

If the device upgrade is not successful, click **Upgrade** again to retry.

If retrying does not work:

- Do a power cycle of the Xanbus device that is being upgraded.
- Then, click **Upgrade** on the web interface.

4

Monitoring

Chapter 4 describes the many ways the Conext ComBox – Freedom SW can monitor system components.

It includes:

- Monitoring LEDs
- Monitoring Conext ComBox Status Information
- Monitoring System Components
- Managing Data Logs

Monitoring LEDs

LED indicators allow you to monitor the functioning of the Conext ComBox. There are five LEDs in the upper right corner of the Conext ComBox:

- Power
- Memory
- Xanbus
- Modbus
- Status

All LED indicators are green except for the amber Status indicator.

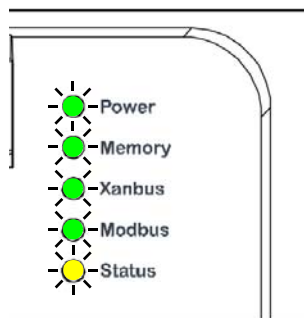

Startup

The Power LED flashes slowly when the Conext ComBox application is loading and flashes quickly during application initialization. The other LEDs illuminate as startup progresses. Once the Conext ComBox is ready, the Power LED turns on steadily. This process takes about two minutes.

Operating Mode



The LED states and descriptions are listed in the following table.

Indicator	State	Description
Power	On	Powered and ready to communicate
	Flashing	The Conext ComBox is rebooting
Memory	Flashing	Logging data to internal memory
Xanbus	On	Actively communicating or transferring data with the Xanbus network
Modbus	Flashing	Receiving messages from a Modbus master, one flash per message
Status	On	Checking the status on a Xanbus device or the Conext ComBox. Checking the web user interface status screen to identify the current state of the device or checking the e-mail for reported faults

Monitoring Conext ComBox Status Information

You can view the current settings for the Conext ComBox without making changes.

To view Conext ComBox Status Information:

1. Click  in the menu bar.
2. Click  in the left side menu to display the status information screen.

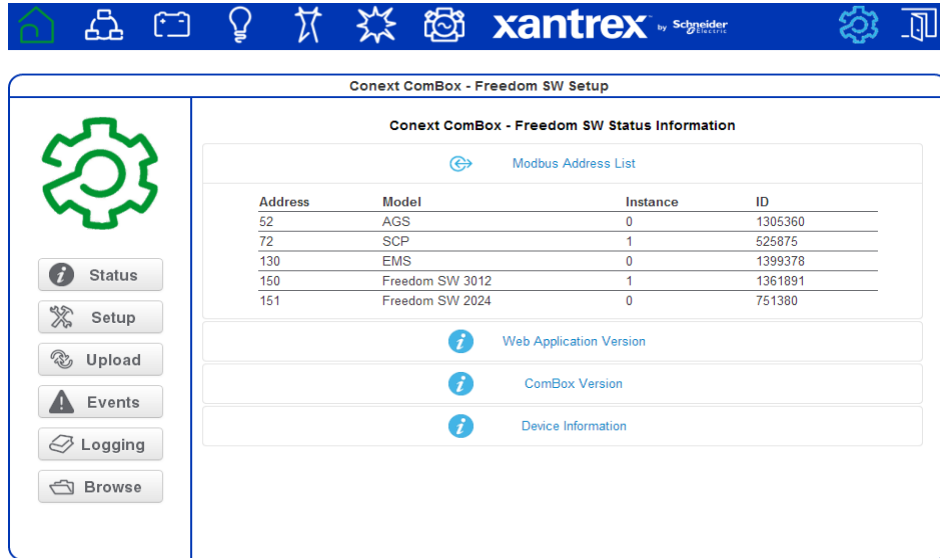

- Click the setting type you want to view.
The selected setting expands to display the options for that setting as shown in the following screen. The size and content of the expanded window varies depending on the setting type.

Modbus Address List

Note: Modbus support is available only for the Conext ComBox (Part Number 865-1058), and Conext Modbus Converter (Part Number 865-1059), used with Schneider Electric Conext series inverter products.

The Modbus Address List displayed with this Conext ComBox – Freedom SW (Part Number 809- 0918), is not required for operation or supported by Xantrex technical support.

Web Application Version

Displays information about the Conext ComBox web user interface. It shows the build and version number.



Conext ComBox Version

Displays information about the Conext ComBox firmware. It shows the application version and its build date. It also shows the bootloader version and its build date.

Device Information

Displays information about the Conext ComBox hardware such as the Device name. It shows the model number, serial number, and hardware revision number. It also shows the MAC address, IP address, and hostname.

Conext ComBox - Freedom SW Status Information

 Modbus Address List	
 Web Application Version	
Field	Value
Version	1.0.33
Build Date	2014/01/16 08:19:07

 ComBox Version	
Field	Value
Application Version	Ver01.00BN0033
Application Build Date	2014-01-16_08-17-47
Bootloader Version	Ver01.02BN0087
Bootloader Build Date	2013-08-23_09-40-38

 Device Information	
<pre> Device Info: Conext ComBox - Freedom SW by Xantrex Model Number: 809-0918 Serial Number: B12761901 Hardware Revision: Rev-F Device Name: Box of Com! MAC Address: 00-00-54-EE-01-1C IP Address: 192.168.88.69 Hostname: cb-B12761901 Software ID: 150-0288 Kernel Version: 1.31 Application Version: Ver01.00BN0033 Application Build Date: 2014-01-16_08-17-47 Boot Loader Version: Ver01.02BN0087 Boot Loader Build Date: 2013-08-23_09-40-38 Modbus Map Version: A.2 Date and Time: 2014/01/17 10:40:52 Time Zone: (-08:00)Pacific-Time_US_Canada_Tijuana </pre>	<p>Note: The information displayed in these examples will be different from those in your Conext ComBox.</p>

Monitoring System Components

The system components are: devices, battery, loads, grid, solar, and generator.

- Devices - refers to the Xanbus units, such as inverter/chargers, automatic generator starters (AGS), and system control panels (SCP).
- Battery - refers to the total energy stored in the battery system. It monitors energy during charging as well as discharging.
- Loads - generally refers to total energy that is being used by electrical appliances and machines directly connected to the inverters in the system. It is not a specific appliance or machine.
- Grid Support- not available in this version of Conext ComBox – Freedom SW.
- Solar - reserved for future use. A Xanbus-enabled solar charge controller certified for use on vehicles and boats is not currently available.
- Generator - refers to energy that is produced by a generator and accepted in the system.

Devices



When you click the Devices icon you obtain direct access to all individual Xanbus-enabled devices, allowing you to monitor and configure the settings of each Xanbus-enabled device. Your commands are communicated from the web user interface to each device, effectively controlling them remotely.

To access a Xanbus-enabled device:

1. Click the Devices icon from the home screen or menu bar. The Devices screen opens.

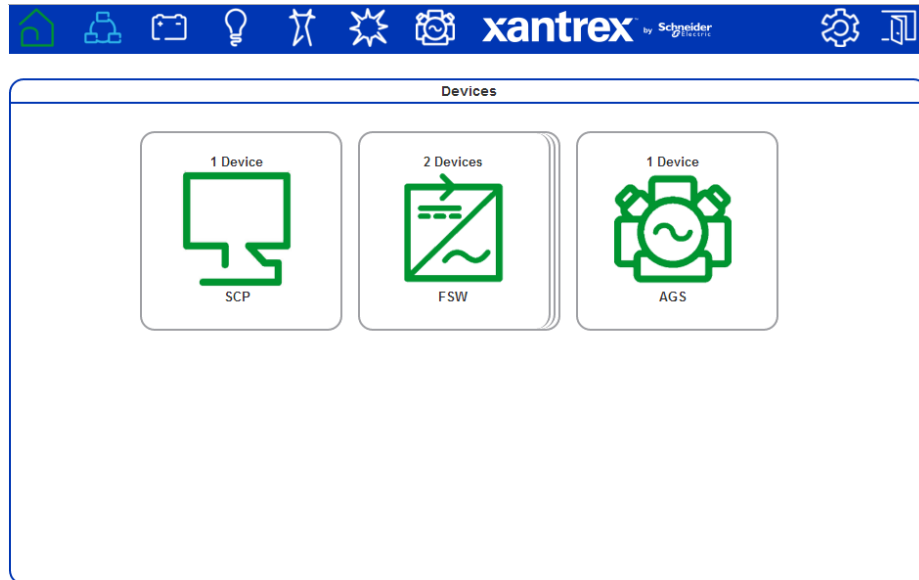

- Click the device you want to monitor or control from the Devices screen. The Device Summary Table screen opens up. If there are more than one of the same device type, the devices will be listed in the summary table.

FSW Device Summary Table

Name	Config.	Grid [W]	Load [W]	Grid [V]	Grid [Hz]	Batt [V]	Batt [A]	Batt [°C]
✓ FSW2024 (0)	Slave	0	0	0.0	0.0	5.4	0.0	27.0
✓ FSW3012 (1)	Master	0	0	0.0	0.0	5.5	0.0	N/A
		Σ 0	Σ 0			Σ 0.0		

- Click the specific device listed in the summary table that you want to monitor or change settings. The Device Status screen opens.

FSW (1)

Device Status

Parameter	Value
Device Name	FSW3012
FGA Number	815-3012
Unique ID Number	1361891
Firmware Version	V03.01.04-0000
Modbus Address	150
Device Present	Active (data valid)
Inverter Enabled	Enabled
Charger Enabled	Disabled
Device State	Safe Mode
Inverter Status	Inverter Disabled
Charger Status	Qualifying APS
Active Faults Flag	No Faults
Active Warnings Flag	No Warnings
Battery Voltage	5.4 V
Battery Current	0.0 A
Battery Power	0 W
Invert DC Current	0.0 A
Charge DC Current	0.0 A
Invert DC Power	0 W
Charge DC Power	0 W

use for information and monitoring → [Status, Meters, Settings, Events]

use for control and configuration → [Settings, Events]

The Device Status screen is the initial screen. Click **Status** in the left side menu if you want to return to this screen after navigating away from it.

- Click **Meters** in the left side menu, if you want general energy-related information gathered by the device, such as energy consumption, output, and load.

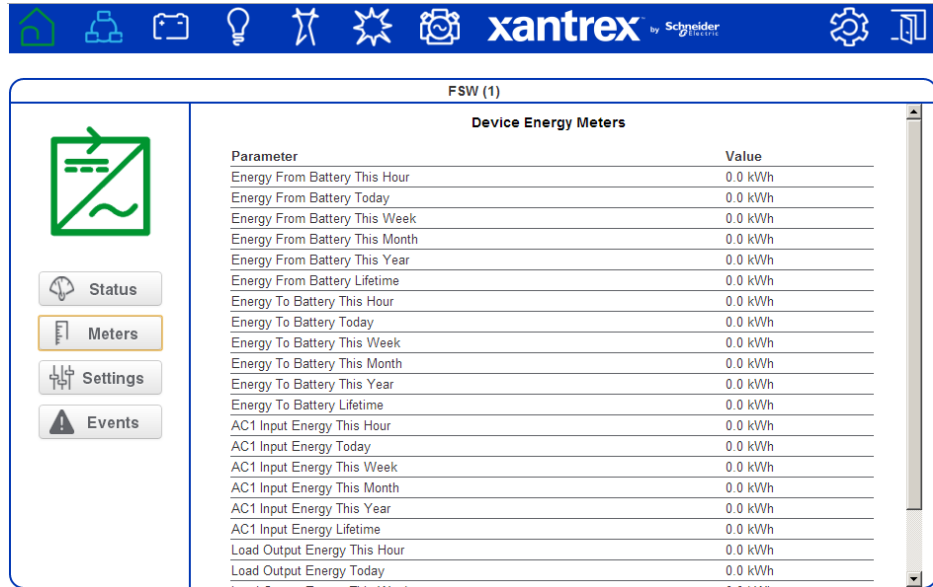

- Click **Events** in the left side menu, if you want information about faults and warnings reported by the device.

NOTICE

EQUIPMENT DAMAGE

- Consult the device Owner’s Guide when changing the device’s settings.
- Ensure that the Xantrex-enabled device connected to the network is in standby mode before changing settings. See “To set a device in Standby mode:” on page 3–31.
- Do not change any settings unless you are familiar with the device.

Failure to follow these instructions can damage equipment.

- Click  Settings in the left side menu.

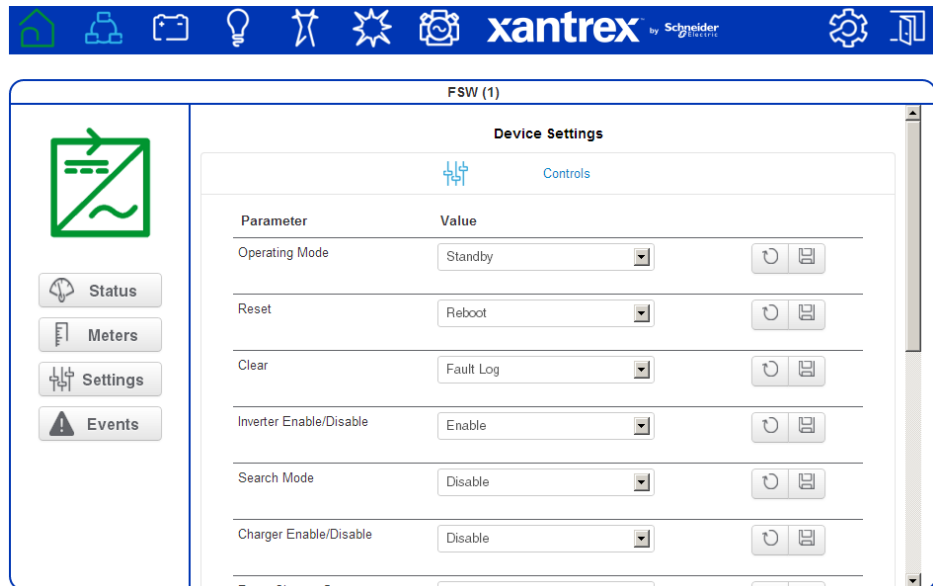

You will see a list of **Device Settings** for that type of device.

- Before making any changes, put the device on standby mode. See “To set a device in Standby mode:” on page 3–31.
- Change the settings accordingly.

System Component Energy Graphs

Each of the system components, except Devices, generates an interactive energy graph that allows you to monitor energy readings of the Battery, Loads, and Generator. Aggregate energy information collected on a daily, weekly, monthly, and yearly basis can be displayed for each of the components using bar and line graphs. Using the graphs as an aid, you can analyze your system's performance and maximize its energy consumption. You can make decisions on effective load management, and find areas for energy efficiency.

Note: For a description of each graph element refer to the following table on page 4-11.

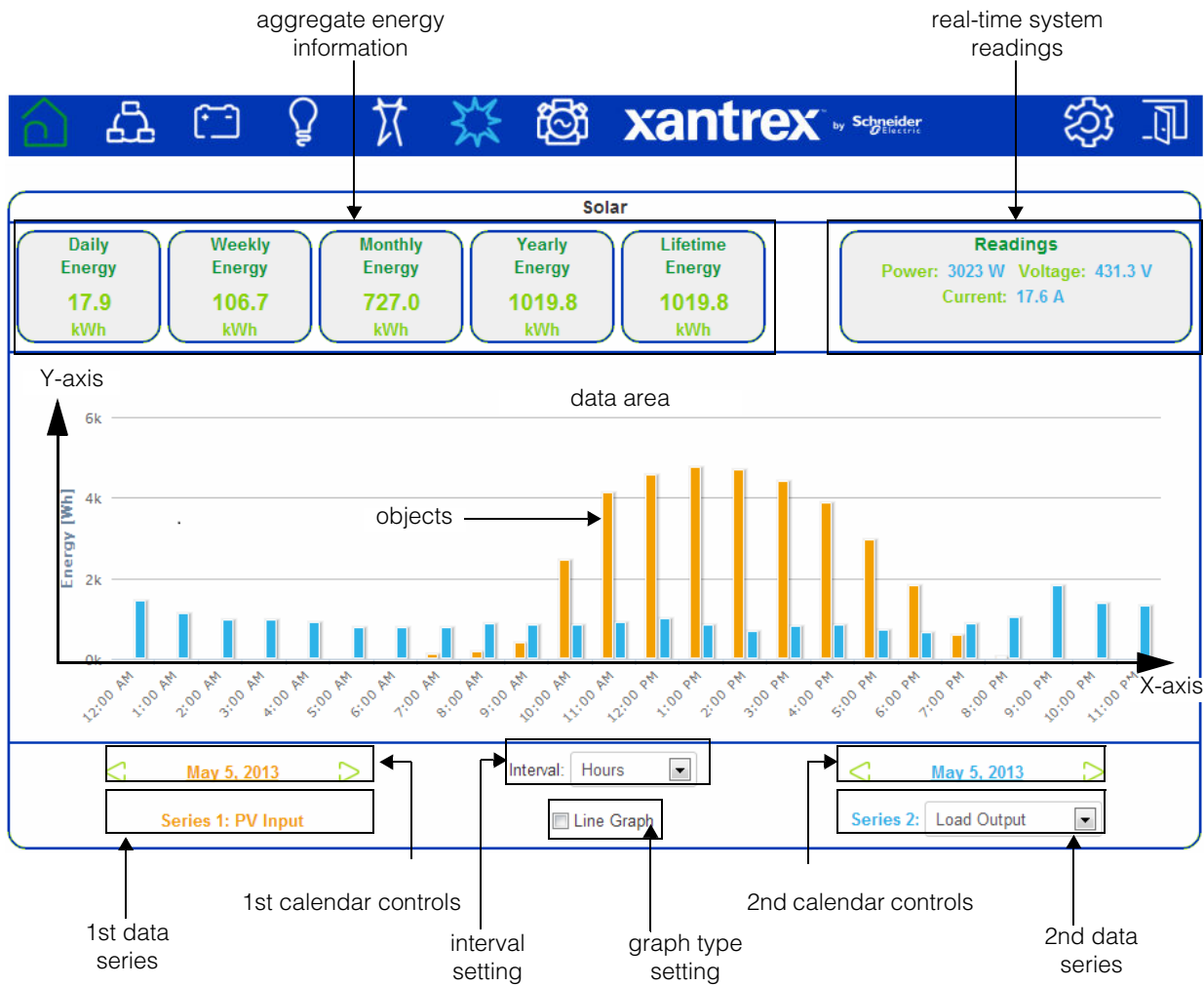

Graph Element	Description
Aggregate Energy Information	<p>Displays total energy used by the system component. It accumulates data on a daily, weekly, monthly, yearly, and lifetime basis.</p> <ul style="list-style-type: none"> • <i>Daily</i> aggregates information collected at the start of the day (12:00AM), up to the most recently completed hour. • <i>Weekly</i> aggregates data starting from the most recent Sunday up to the most completed day to date. • <i>Monthly</i> sums up all information for the current month from day 1 up to the most completed day to date. • <i>Yearly</i> sums up all information for the current year from month 1 up to the most completed month to date. • <i>Lifetime</i> aggregates all data collected from the very beginning the system started. <p>Important: Energy aggregation is based on the data collected by ComBox. Actual lifetime energy for each device may differ.</p>
Real-Time System Readings	Displays real-time information on the system component selected.
Data Area	This is where the graph is presented. If you hover the mouse pointer over the data area, an information bubble containing information on the object displays.
X-Axis	The X-axis label generally represents time. The tick mark labels on the X-axis change depending on the time Interval Setting selected. For example, if the Interval Setting is Hours, then the tick mark labels will be each hour of the day starting from 12:00 AM.
Y-Axis	The Y-axis label is Energy in watt-hours (Wh). The tick mark labels on the Y-axis adjusts accordingly. For example, if the watt measurement expands to kilowatts, then the labels will appear with a "k".
Data Series	<p>There are two data series. This means that you can display two different data sets which you can analyze and compare.</p> <p>The 1st Data Series (represented in Orange) always pertains to a data set or data sets belonging to the system component selected. For example, if the system component is Battery, then the 1st Data Series could either be Battery Charge or Battery Discharge. For sources like Generator, which have power flow in only one direction, there will be only "input" energy viewable in the 1st Data Series.</p> <p>The 2nd Data Series (represented in Blue) pertains to data sets belonging to all the system components. Collectively, the data sets of all system components are Load Output, PV Input, Battery Discharge, and Battery Charge.</p>
Calendar Controls	<p>There are two calendar controls. The 1st Calendar Controls (also in Orange) is meant for the 1st Data Series. The 2nd Calendar Controls (in Blue) is for the 2nd Data Series.</p> <p>The controls are the left arrow, right arrow, and the calendar pop up link in between the two arrows. When you click the calendar pop-up link, it displays a calendar selector application.</p>

Graph Element	Description
Interval Setting	The interval setting changes the Y-axis label to one of four choices: Hours, Days, Months, or Years.
Graph Type Setting	By default, the graph displays bars. You have the option to display a line graph simply by selecting the check box next to the Line Graph.

Interpreting a Battery Energy Graph

This graph compares energy from shore power (Series 1) versus energy that is stored during charging (Series 2).

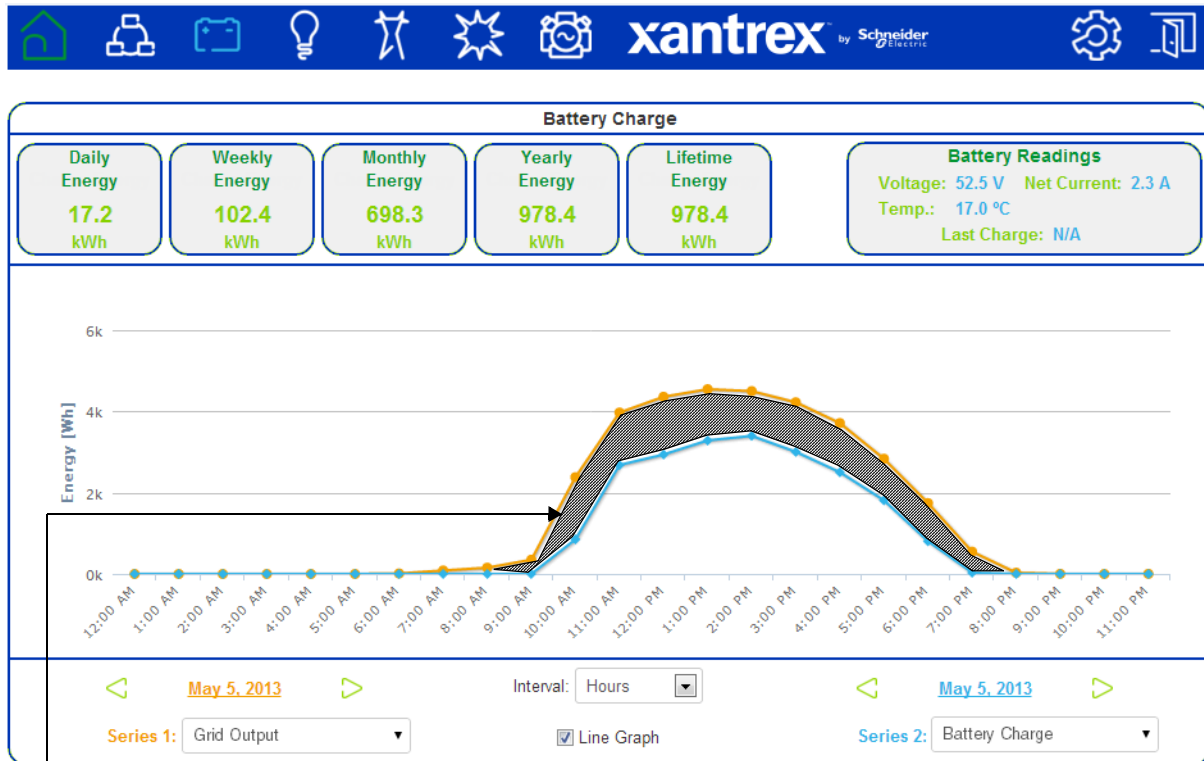

Observation #1: This is net energy that is consumed by loads that are backed up by Freedom SW inverters.

Interpreting a Load Energy Graph

This graph compares energy consumed by system loads versus energy received from the utility grid (shore power).

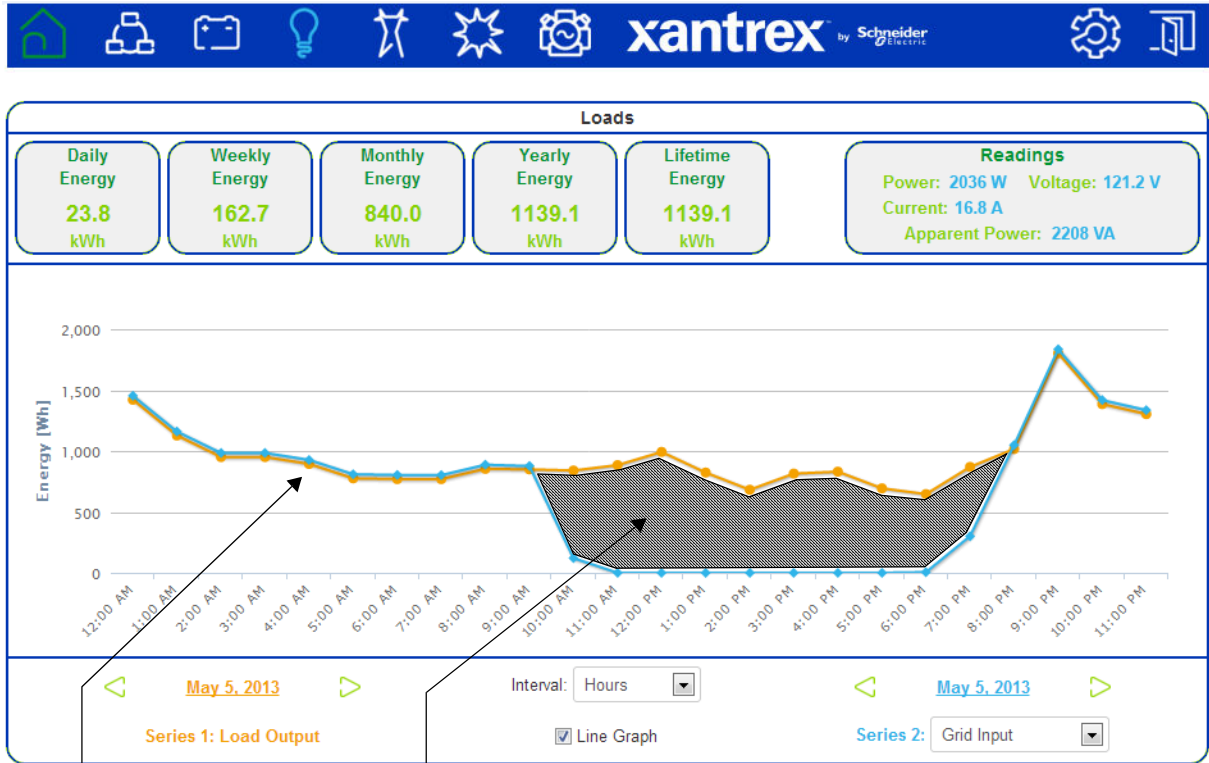

Observation #1: The loads are receiving pass-through energy from the grid (shore power).

Observation #2: The system is disconnected from shore power and is running off the battery.

Interpreting a Generator Energy Graph

This graph compares the total generator input versus battery discharge for a site operating in a diesel cycle charging application. The baseload was approximately 10-12 KW average throughout the day, represented by the blue bars. The orange bars represent the total energy from the generator to power the loads and charge the batteries again.

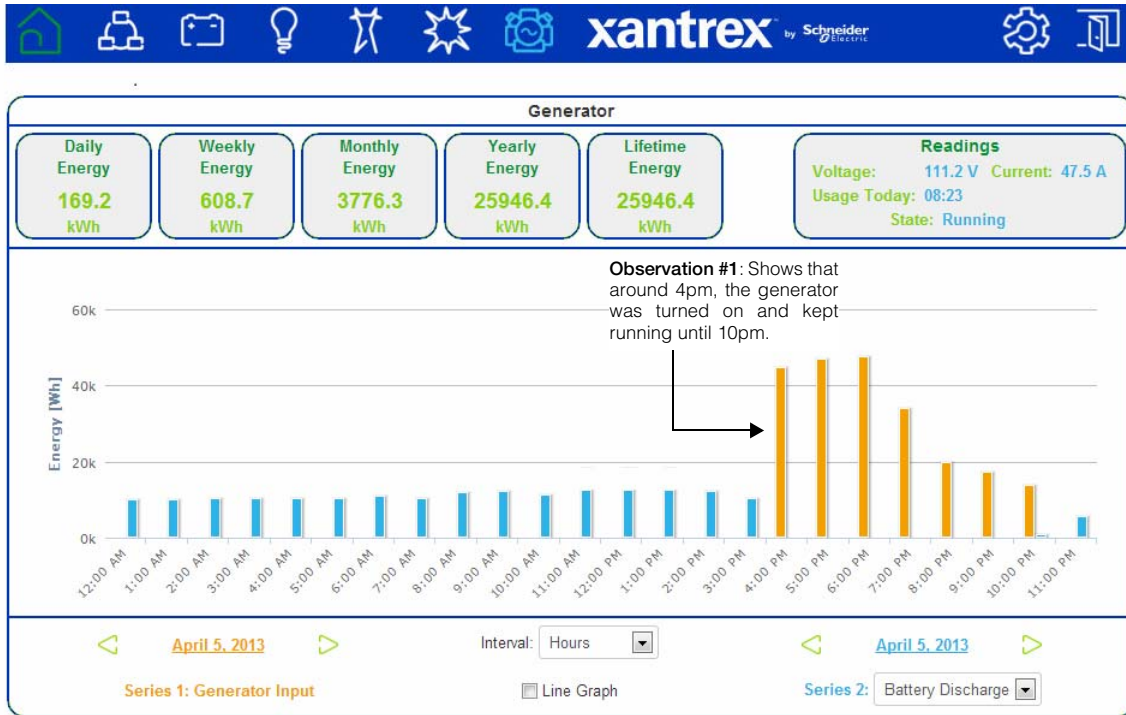

Important: This graph is based on a diesel cycle charging application and is shown for illustration purposes only. Different systems perform variably and the graph above may not be typical.

Managing Data Logs

Data logging is an integral function of the Conext ComBox. Data logs record vital information about the electrical system including information about devices in the Xanbus network. Information such as energy consumption, battery charging status, generator output, and system fault detections cannot be displayed in a useful manner without taking data out of data logs. There are two types of data logs - Events and custom Logs.

Events Log

The Conext ComBox records its own device events as well as system-wide faults and warnings that have been detected. You can display this information by accessing the Events log.

To access the Events Log:

1. In the menu bar, click .
2. Click  in the left side menu to display the System Events screen.

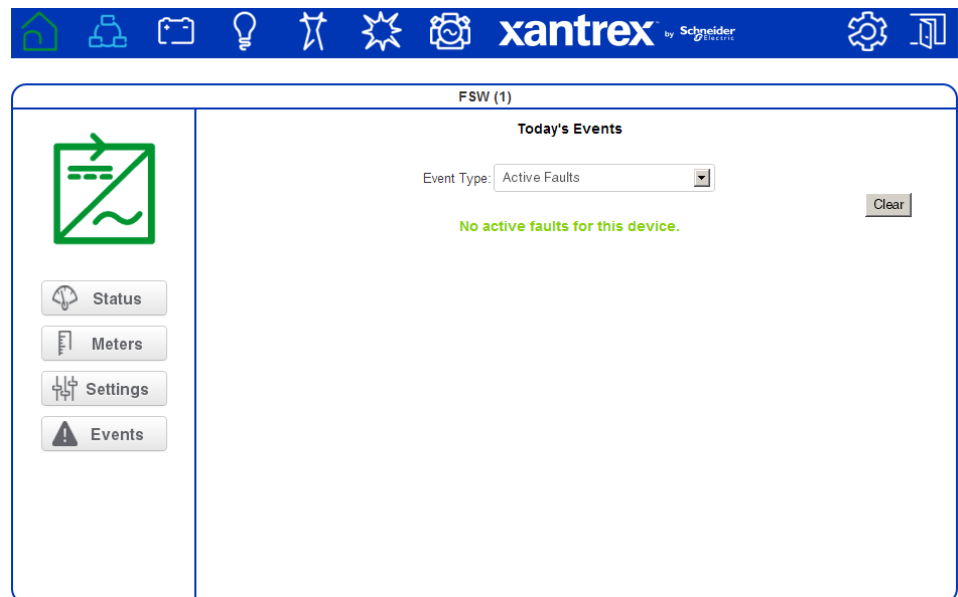



3. Select an **System Event Type** from the list to display active and historical faults and warnings. The event record includes the ID of each device that reported a fault, the time it occurred, and a brief description.

Custom Logs

The Conext ComBox records custom data logs and stores them in the SD card inserted in the micro-SD port. You can display this information by clicking the Logging button.

To access the custom Logging information:

1. In the menu bar, click .
2. Click  in the left side menu.
A screen, similar to the example shown below, displays.

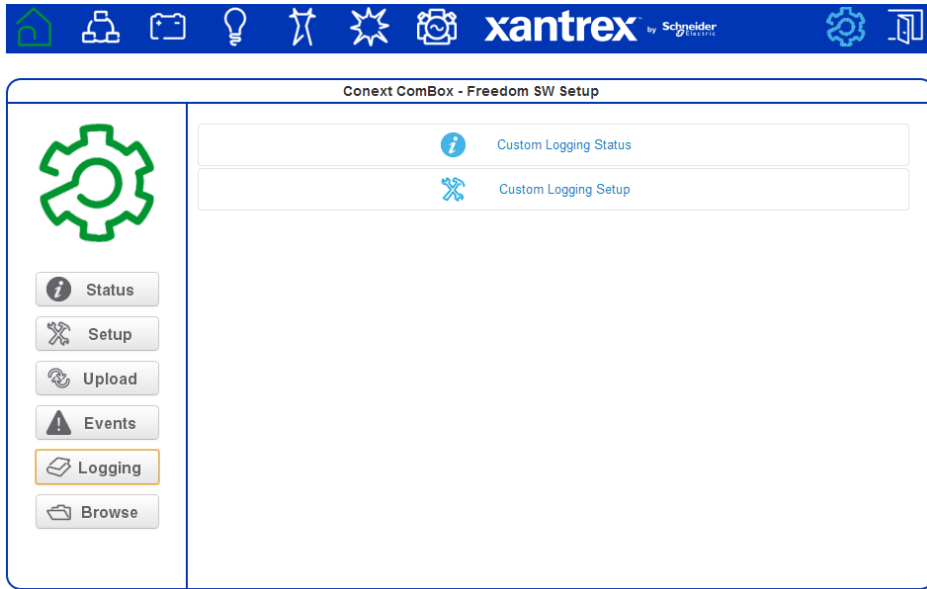

3. Click Custom Logging Status to display logging information.

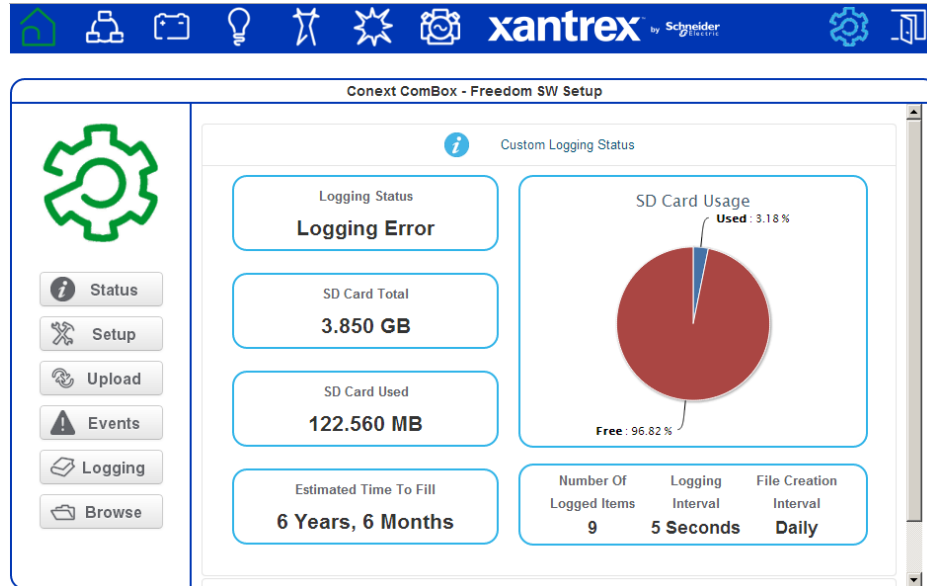

The **Custom Logging Status** displays current information about the micro SD card. It displays logging status, the number of logged items, and the frequency of logging and file creation.

4. Click **Custom Logging Setup** to display the settings for logging.

Custom Logging Setup allows you to enable and disable logging. You can change logging intervals and choose devices and the associated events that get recorded in the logs. Currently, you can record up to 20 parameters.

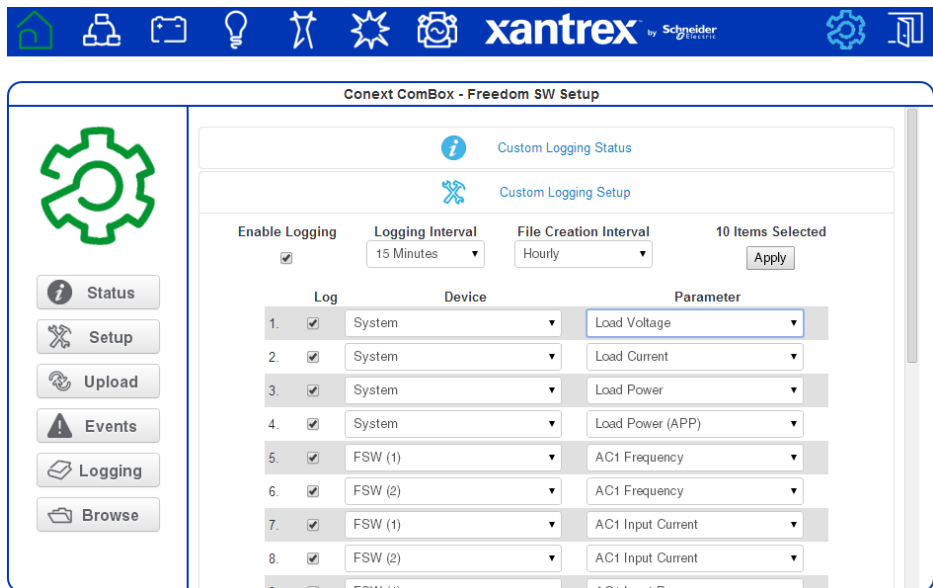

Accessing and Downloading Log Files

Log files are saved internally using onboard memory and externally using a micro-SD card. The Conext ComBox web user interface allows you to browse through log files within a simple file system.

To access the log files:

1. In the menu bar, click .
2. Click  in the left side menu to display the System Log Browser.

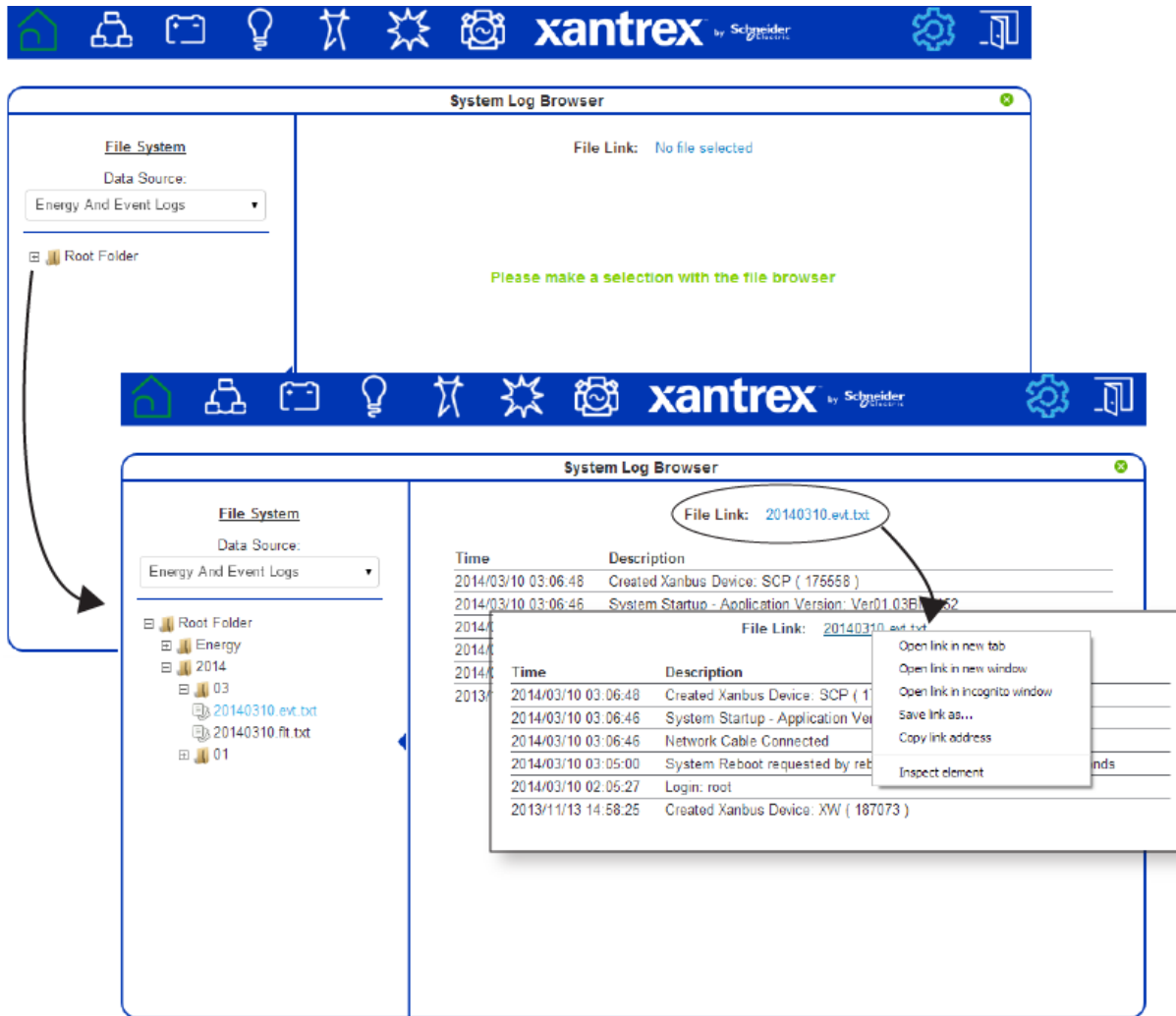

There are two data sources: **Energy And Event Logs** and **Custom Data Logs**. The energy and event logs are stored internally in the Conexx ComBox memory and the custom data logs are stored in an external micro-SD card.

Expand each folder in the File System list to search for log files. The folders represent device names and are organized by year and the numerical month. Click a log file in the list to display it in the System Log Browser pane. If the file cannot be displayed, a message similar to the one below explains a course of action.

*This file type cannot be displayed,
please right-click the file link to save this file to disk.*

To download the logs to a hard drive or another storage device, right-click the File Link on top of the main screen, and select Save Link As to save the log to a location.

5

Troubleshooting

Chapter 5 describes event and alert indicators and resolutions to issues that might be encountered when installing or operating the Conext ComBox– Freedom SW.

It includes:

- Viewing Xanbus Device Faults and Warnings
- Viewing System Events
- Viewing Faults and Warnings
- Browsing System Event and Fault Log Files
- Browsing Energy Log Files
- Common Solutions

Viewing Xanbus Device Faults and Warnings

If the Devices icon on the Conext ComBox home screen is flashing red or orange, it indicates that one or more Xanbus devices has a fault (red) or warning (orange).

Note: The Freedom SW has one AC input. Your ComBox will be configured to display GRID or GENERATOR power flow (but not both at the same time).

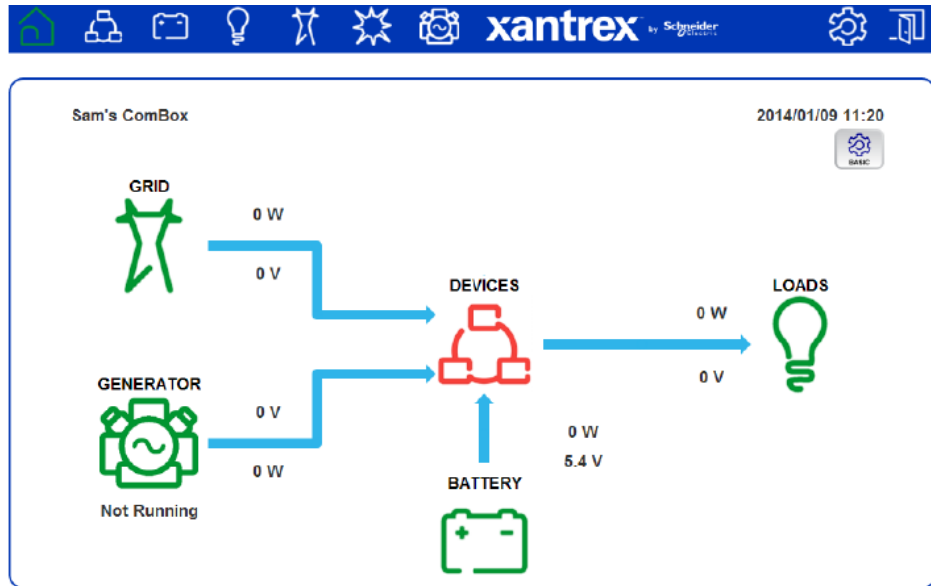

To determine the cause of the fault or warning:

1. Click the flashing red or orange Devices icon to open the Devices page.

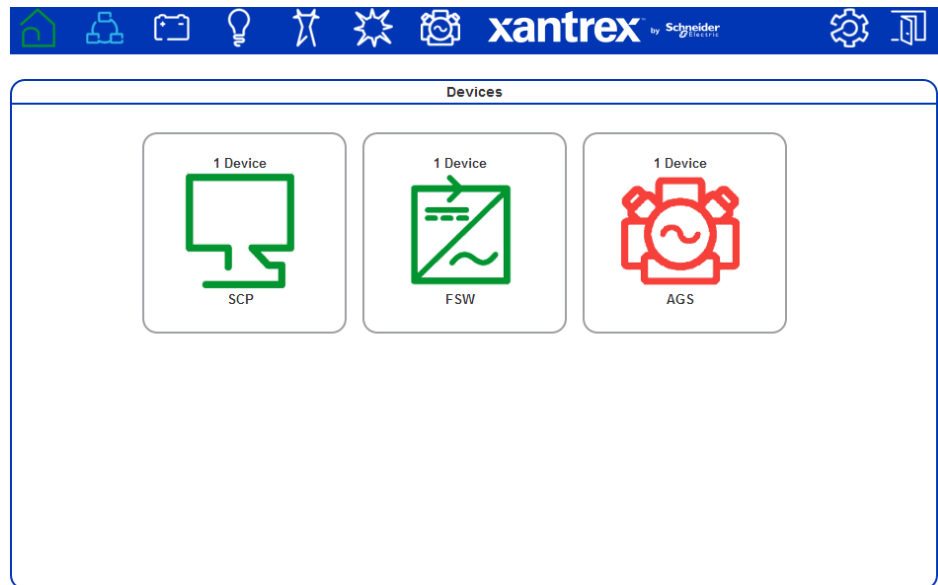

2. Click the device with the fault or warning you want to examine. In this example, click the red AGS icon to open the AGS Device Summary Table.

The screenshot shows the "AGS Device Summary Table" in the Xantrex web interface. The table has five columns: Name, State, Action, On Reason, and Off Reason. There is one row of data with a red 'x' icon in the first column.

Name	State	Action	On Reason	Off Reason
✘ XAGS_0	AGS Fault	Running	Unable To Stop	Not Off

3. Click ✘ or the device name to view the device status.

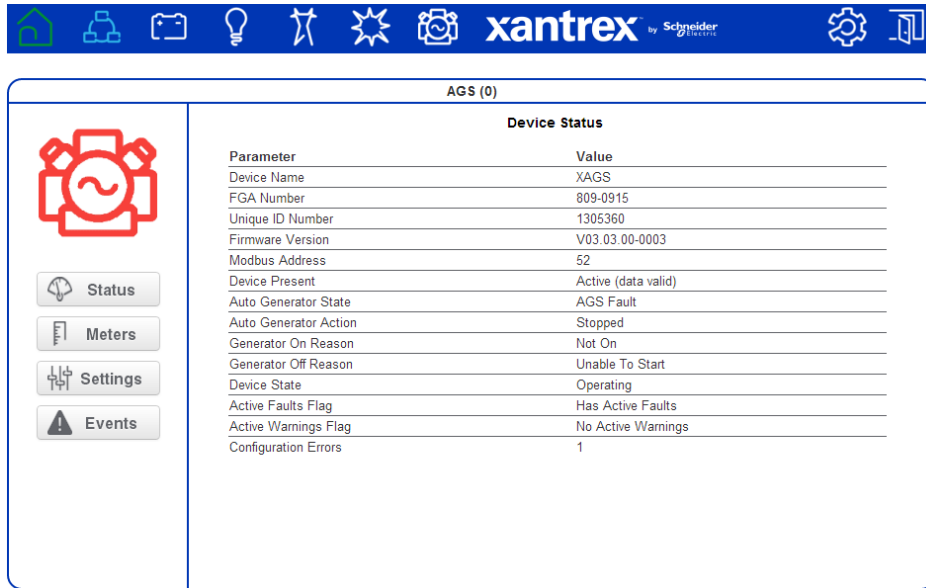

The screenshot shows the Xantrex AGS (0) Device Status page. The top navigation bar includes icons for home, network, folder, lightbulb, wrench, starburst, camera, and the Xantrex by Schneider Electric logo. The main content area is titled "AGS (0)" and features a sidebar with a red gear icon and buttons for "Status", "Meters", "Settings", and "Events". The "Device Status" table lists various parameters and their values.

Parameter	Value
Device Name	XAGS
FGA Number	809-0915
Unique ID Number	1305360
Firmware Version	V03.03.00-0003
Modbus Address	52
Device Present	Active (data valid)
Auto Generator State	AGS Fault
Auto Generator Action	Stopped
Generator On Reason	Not On
Generator Off Reason	Unable To Start
Device State	Operating
Active Faults Flag	Has Active Faults
Active Warnings Flag	No Active Warnings
Configuration Errors	1

4. Click Events.

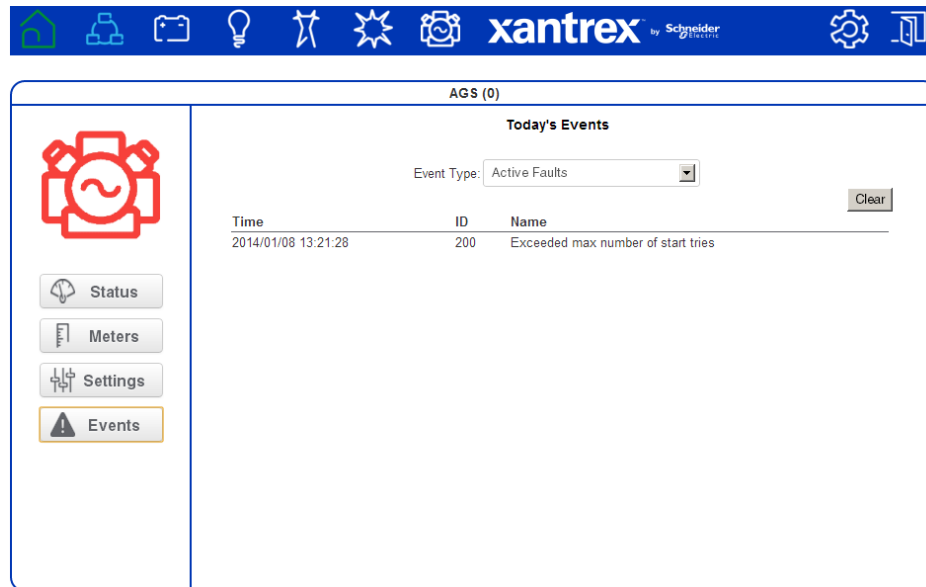

The screenshot shows the Xantrex AGS (0) Today's Events page. The top navigation bar is identical to the previous screenshot. The main content area is titled "AGS (0)" and features a sidebar with a red gear icon and buttons for "Status", "Meters", "Settings", and "Events". The "Today's Events" section includes a dropdown menu for "Event Type" set to "Active Faults" and a "Clear" button. Below this is a table listing events.

Time	ID	Name
2014/01/08 13:21:28	200	Exceeded max number of start tries

5. Select the Event Type. You can choose one of these options: **Active Faults**, **Historical Faults**, **Active Warnings**, or **Historical Warnings**. In the following example, **Active Faults** has been selected to get a list of the current active faults.
6. Mouse over the fault name to get a detailed description of the fault.

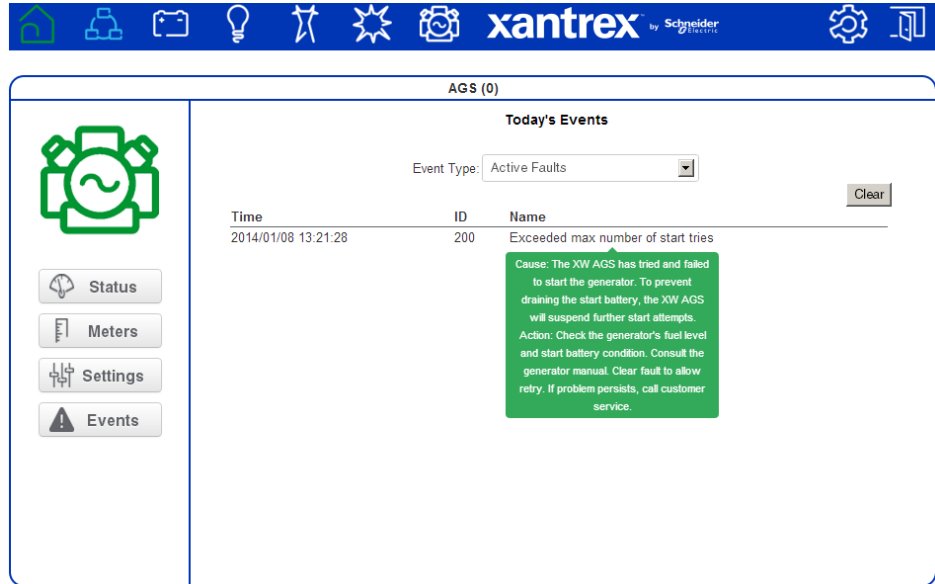

Viewing System Events

You can use the system event list to troubleshoot the ComBox operation. The system event list only shows events from today.

To view the events only from today:

1. Click  in the menu bar.
2. Click **Events** in the left side menu.
3. Select **Events** in System Event Type.

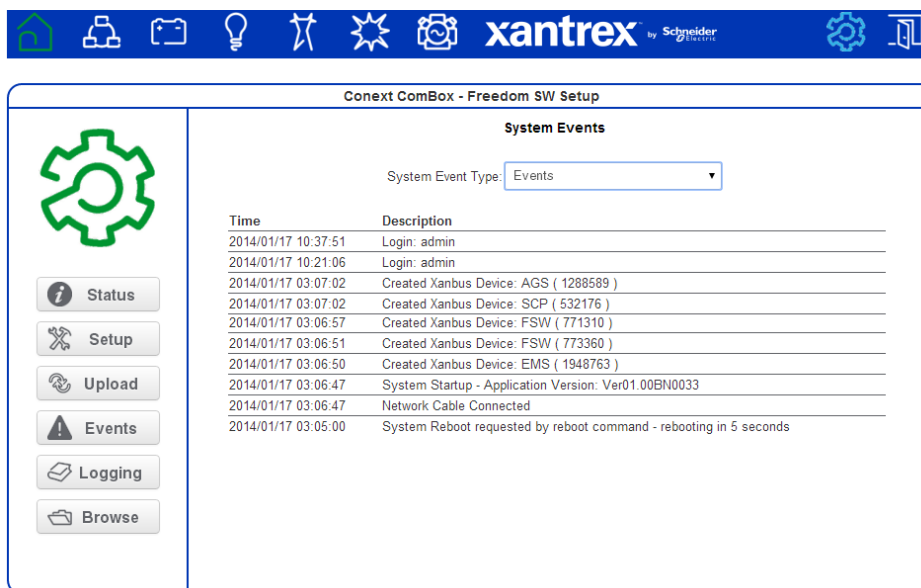

Time	Description
2014/01/17 10:37:51	Login: admin
2014/01/17 10:21:06	Login: admin
2014/01/17 03:07:02	Created Xanbus Device: AGS (1288589)
2014/01/17 03:07:02	Created Xanbus Device: SCP (532176)
2014/01/17 03:06:57	Created Xanbus Device: FSW (771310)
2014/01/17 03:06:51	Created Xanbus Device: FSW (773360)
2014/01/17 03:06:50	Created Xanbus Device: EMS (1948763)
2014/01/17 03:06:47	System Startup - Application Version: Ver01.00BN0033
2014/01/17 03:06:47	Network Cable Connected
2014/01/17 03:05:00	System Reboot requested by reboot command - rebooting in 5 seconds

The events are listed in chronological order. Use the scroll bar to navigate through the list.

Note: System events show only the events for the current day. If you want to view system events from previous days, use the file browser navigator.

Viewing Faults and Warnings

You can use the Faults and Warnings event list to troubleshoot the ComBox and Xanbus device operation. The list displays all faults and warnings with timestamps in a common place.

To view system faults and warnings:

1. Click  in the menu bar.
2. Click **Events** in the left side menu.
3. Select **Faults and Warnings** in System Event Type.

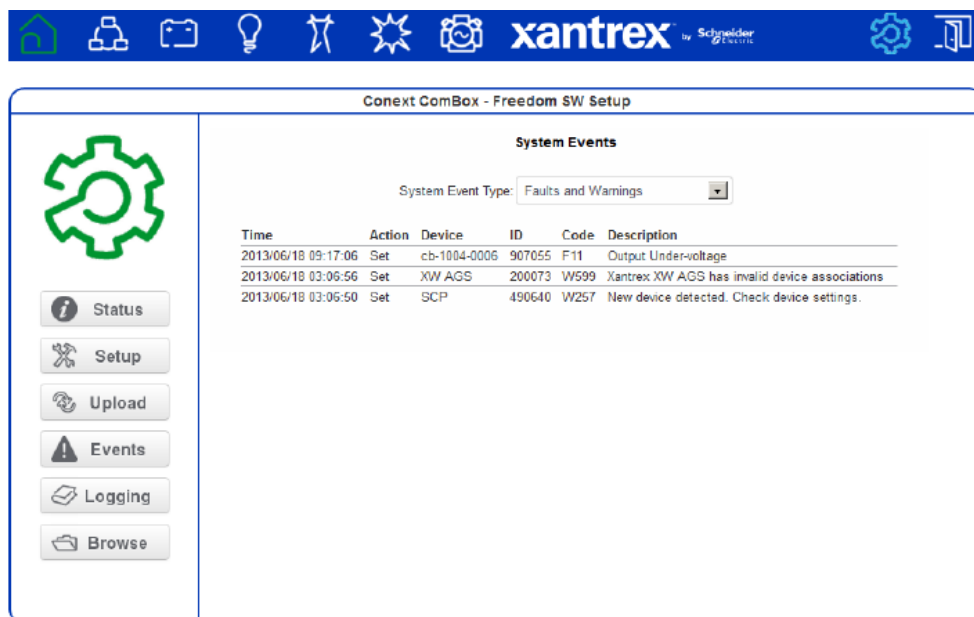

The screenshot displays the 'Conext ComBox - Freedom SW Setup' web interface. At the top is a blue navigation bar with icons for home, network, folder, lightbulb, wrench, star, camera, 'xantrex by Schneider Electric', and settings. The main content area is titled 'System Events' and features a dropdown menu for 'System Event Type' set to 'Faults and Warnings'. Below this is a table with the following data:

Time	Action	Device	ID	Code	Description
2013/06/18 09:17:06	Set	cb-1004-0006	907055	F11	Output Under-voltage
2013/06/18 03:06:56	Set	XW AGS	200073	W599	Xantrex XW AGS has invalid device associations
2013/06/18 03:06:50	Set	SCP	490640	W257	New device detected. Check device settings.

On the left side of the interface, there is a sidebar with a large green gear icon and several buttons: Status, Setup, Upload, Events, Logging, and Browse.

Browsing System Event and Fault Log Files

To browse log files:

1. Click  in the menu bar.
2. Click **Browse** in the left side menu.
3. In Data Source, select **Energy and Event Logs**.

- Click the root folder to expand the file tree.

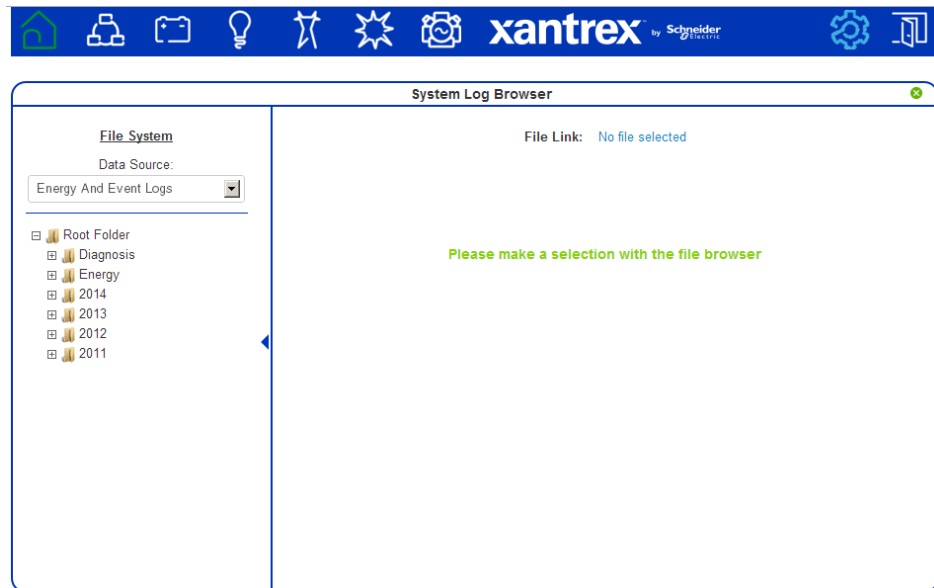

The root folder contains the following folders:

- A Diagnosis folder, which contains diagnostic data for use by Schneider Electric only,
 - An Energy folder, which contains energy log data for the attached Xanbus devices.
 - One or more yearly folders containing event and fault log data.
- Under the root folder, click to the year folder, and then click to expand the month within the selected year.

The files in the month folder are in the following format: *yyymmdd.evt.txt* (event log files) and *yyymmdd.ft.txt* (fault log files).

- Click a log file to display it in the right-hand preview pane.

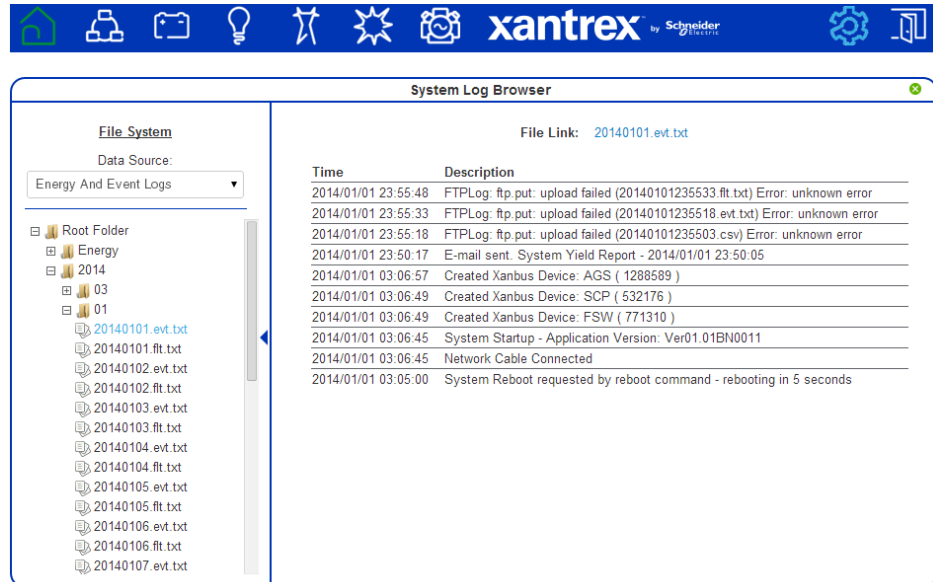

- To open the log file in a separate browser window, click the File Link at the top of the preview pane.
- To save the log file to a local copy on your computer, right-click the File Link at the top of the preview pane and select **Save link as...**

Browsing Energy Log Files

To browse energy log files:

- Click  in the menu bar.
- Click **Browse** in the left side menu.
- In Data Source, select **Energy and Event Logs**.
- Click the root folder to expand the file tree.

5. Expand the Energy folder.

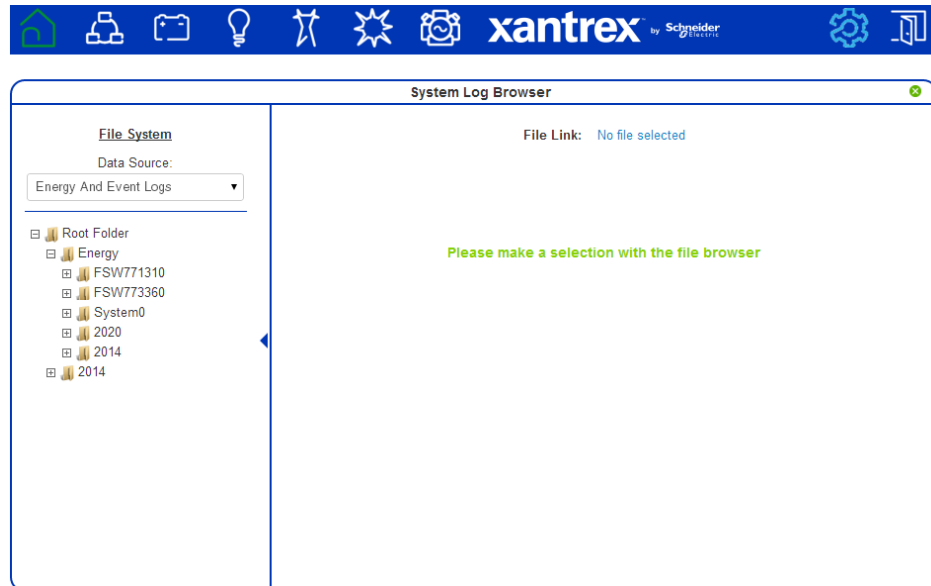

Energy data is arranged by device and by year.

- **FSW** device folders that appear in the root contain the lifetime energy data logs for each Freedom SW. Device folders within a time period folder (such as **2014**), contain data logs for the year, month or day.
- System folder (**System0**) contains the total energy consumption of all devices in the system.
- Year folders contain data logs for the specified year, arranged by device, month, and day.
- Data logs are named according to the port type on the device. For example: **AC1In.log**, **ACLoad.log**, **DCInput.log**, and **DCOutput.log**.

For example, to drill down to an energy log on a specific day:

- In the File System list, click **Root Folder > Energy > Year > Month > Day > Device > Data log file.**

Starting at the Root Folder, drill down until you display the log file you need

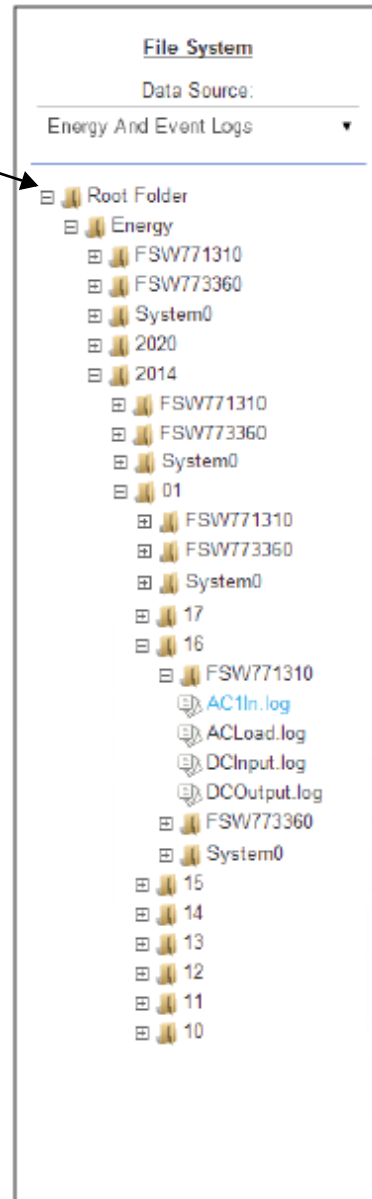

6. Click a **.log** file to display the data in the right-hand pane. For example, click **AC1In.log** to display the energy (in Watt Hours) generated on the Freedom SW AC1 output for each hour of the day.

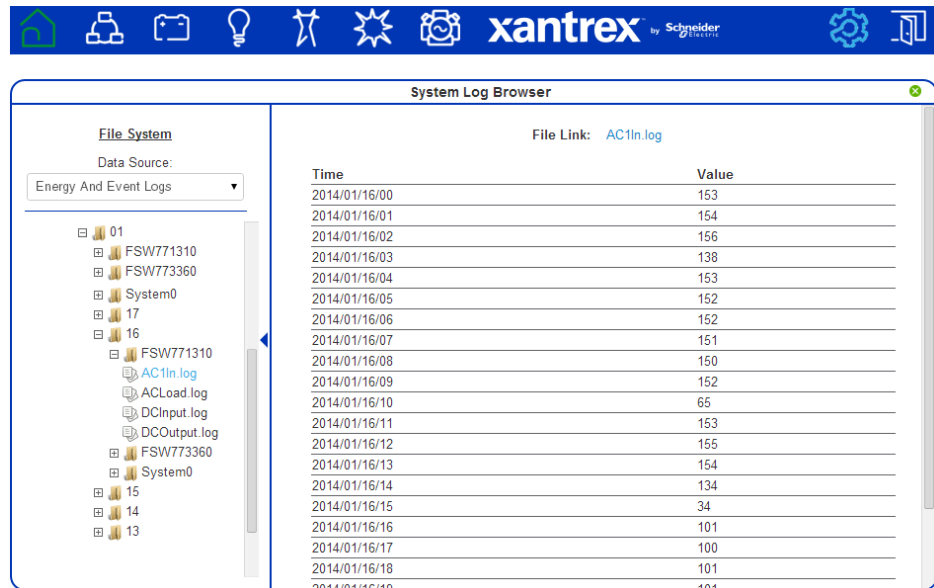

- To open the log file in a separate browser window, click the File Link at the top of the preview pane, then right-click and select **Save link as...**

Common Solutions

Problem	Symptom	Solution
Device Discovery Tool cannot find the Conext ComBox.	The Conext ComBox is not listed in the results list from the search.	<p>Check to see if the Power indicator is on.</p> <p>Check all Conext ComBox connections to make sure they are secure.</p> <p>Check the configuration settings. See “Changing Advanced Conext ComBox Settings” on page 3–15.</p> <p>Check that there are no faults with the Ethernet cables.</p>
Unexpected behavior in the web user interface.	For example, the Loading in progress message continues for an extended period.	<p>An upgrade may have been applied to the Conext ComBox.</p> <p>Clear your web browser cache. See “Clearing a web browser’s cache” on page 3–37.</p>
Firmware upgrade not successful.	Status light is on, and there is a message in the Upload screen.	<p>There may have been a communication event. Restart the upgrade process.</p> <p>Clear the Conext ComBox internal memory. See “Clearing the Internal Firmware Memory” on page 3–36.</p>
Status light is flashing.		If a firmware upgrade is in progress, wait for it to finish. The Status light will turn off on completion.

Problem	Symptom	Solution
Xanbus overload	All devices on the network do not appear in the web user interface. Logged data is random.	The network may exceed traffic limits for the Conext ComBox. The maximum number of devices for the Conext ComBox network is 20.
Conext ComBox does not boot up.	Conext ComBox startup process does not complete.	Reset the Conext ComBox. See "Resetting the Conext ComBox to Factory Settings" on page 3–30.

A

Specifications

Appendix A contains the electrical, mechanical, and environmental specifications for the Conext ComBox – Freedom SW.

Note: All specifications are subject to change without notice.

Electrical Specifications

Communication Interfaces

Xanbus	Connector: 2 x RJ-45 Products Supported: Freedom SW inverter/chargers, Freedom Sequence, Xanbus AGS, Xanbus SCP
Ethernet	Connector: 1 x RJ-45, 10/100 MBPS Server: FTP, Web, Modbus TCP/IP Client: SMTP, SNTP, Auto discovery: DPWS
RS 485	Note: The RS 485 Modbus connector supplied with this Conext ComBox – Freedom SW (Part Number 809- 0918), is not required for operation or supported by Xantrex technical support. Modbus (1 x Connector: Screw 5-terminal, 16-24 AWG, 2-wire serial, 19200 bps)

Data Interfaces

USB 2.0-Host	Connector: USB-A, Protocols: MSD
USB 2.0-Device	Connector: USB-mini B, Protocols: CDC, MSD
Data transfer interfaces	USB Host, USB Device, Micro SD Card
User Interface	Status indicator LEDs on Conext ComBox Web server pages for Configuration and Monitoring functions

Power Supply (SELV or Class 2 Power Sources)

Power Consumption	2 W average / 10 W peak
AC/DC adapter (supplied) ^a	Input: 100-240V AC, 50-60 Hz, 0.6A, Output: 12V DC, 1.5A, 5.5 mm outer, 2.1 mm center-positive jack
Xanbus	When connected to Freedom SW providing 15V DC, 200 mA min
24V on RS 485 Modbus connector	Note: The RS 485 Modbus connector supplied with this Conext ComBox – Freedom SW (Part Number 809- 0918), is not required for operation or supported by Xantrex technical support. 24V DC, 1A max input only through pins 4 and 5

a. When ordering a replacement, reference PN: 0J-921-0023-Z.

Memory

Internal	96 MB Flash
External	Micro-SD Card (Connector: uSD push-push, Class 2 or better recommended)

General Specifications

Weight (device only)	250 g (0.6 lb)
Dimensions (device only) (W × H × D)	6.7 × 4.5 × 2.1 inches (169 × 114 × 54 mm)
Shipping package dimensions (includes device, cables, adapters, connectors, screws, Quick Start Guide)	12.6 × 9.6 × 3.1 inches (320 × 245 × 80 mm)
Shipping package weight	2 kg (4.5 lb)
Housing/Mounting system	ABS Plastic DIN rail: 35 mm top hat Wall mount: 2 screws
IP rating / Mounting Location	IP 20, NEMA 1, Indoor only
Status Display	5 x LEDs
Temperature	Operating: -4 to 122 °F (-20 to 50 °C) Storage: -40 to 185 °F (-40 to 85 °C) Maximum case temperature: 140 °F (60 °C)
Humidity	Operating: < 95%, non-condensing Storage: < 95%

Features

Programmable dry contact relay	Screw 3-terminal, 16-24 AWG, NC-Com-NO, Form: Class 2, 24 V DC, 4 A max SELV input only
Graphical user interface	Internet browser; Android tablet mobile application
Remote firmware upgrades	Yes (ComBox and connected Xanbus devices)
Custom Datalogger	Yes (requires Micro-SD card)
Max. number of Xanbus devices	Up to 20 (depending on the device type)

Regulatory Approvals

EMC immunity	EN61000-6-1
EMC emissions	EN61000-6-3, FCC Part 15 Class B; Industry Canada ICES-003 Class B
Substances / environmental	RoHS



Schneider Electric Products that Work with the Conex ComBox

- Freedom SW 2012 120V/60 Hz (815-2012)
- Freedom SW 3012 120V/60 Hz (815-3012)
- Freedom SW 2024 120V/60 Hz (815-2024)
- Freedom SW 3024 120V/60 Hz (815-3024)
- Freedom SW 2524 230V/50 Hz (815-2524)
- Freedom SW 3524 230V/50 Hz (815-3524)
- Freedom Sequence (815-0912)
- Xanbus System Control Panel (SCP): (809-0921)
- Xanbus Automatic Generator Start (AGS): (809-0915)

Physical Dimensions

Front View

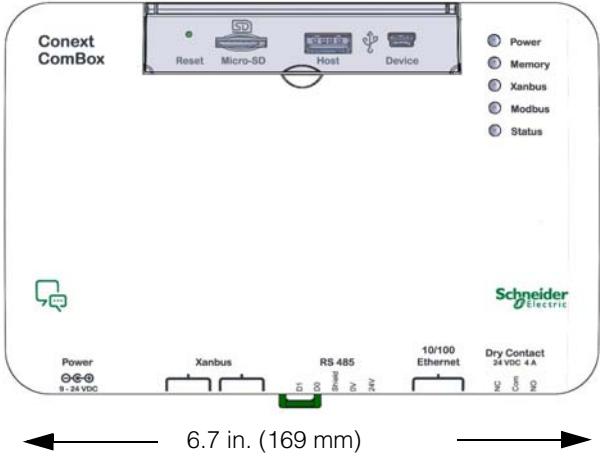

Side View

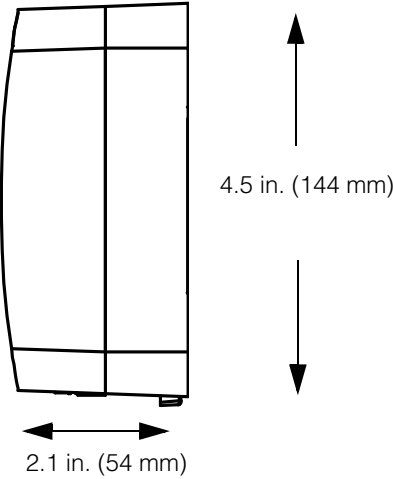

Bottom View

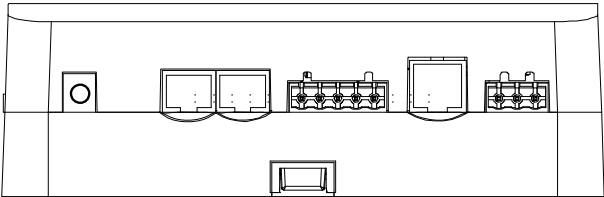

Back View

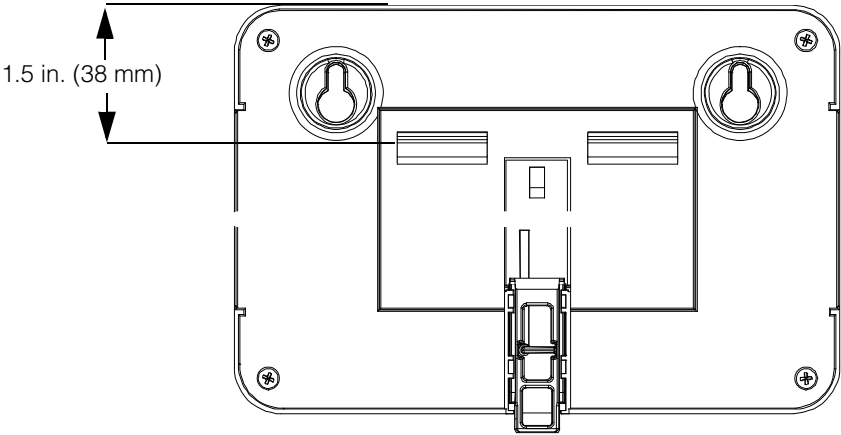

Schneider Electric

www.xantrex.com

For more information, contact Xantrex at 1-800-670-0707, e-mail customerservice@xantrex.com, or visit the Xantrex Website at:

<http://www.xantrex.com>