

MAJESTIC®

MARINE AND RV TV ANTENNA



UFO X RV/UFO X RVB



Product features

Specially compatible with HDTV of various digital terrestrial signal (DVB-T, ISDB-T, DMB-T/H, ATSC) and DAB/FM radios.

The antenna is surface-treated to withstand impacts from saltwater and weather conditions

Build-in high gain and low noise amplifier, shielded for minimum interference.

Waterproof housing design made of UV resistant, injection molded ASA material with super durability.

Omnidirectional antennas receive VHF, UHF, and FM signal from every point regardless of the direction you are travelling.

The best digital terrestrial TV reception solution for your boating and caravans

SMD Technology and micro-electronics makes the high quality amplifier, ensure the excellent antenna performance.

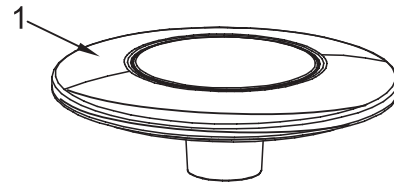

Technical Specification

Frequency range: VHF: 47-230MHz UHF: 470-862MHz

Receiving range: FM/VHF/UHF

Gain: 30dB

Noise figure: 3dB

Max. output level: 110dBμV

Impedance: 75Ω

Connector: F-connectors

Power supply: DC 12V/24V

Included in Packaging:

1. Antenna x 1
2. Lock Nut x1
3. Rubber Boot x1
4. F Connector x1
5. F Socket PAL Plug x1
6. 10M Coax TV Cable x1
7. Wall Plate x1
8. Instruction Manual x1
9. Deck Mount x1



Mounting the antenna:

Option 1. Use the mast mount bracket (not included in the package) to fix the antenna on the boat (Fig. 1)

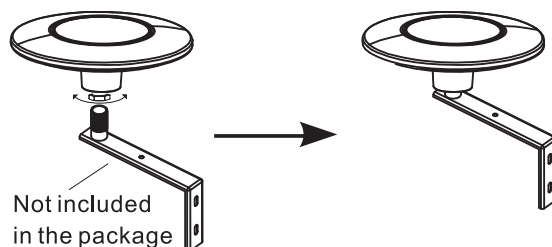
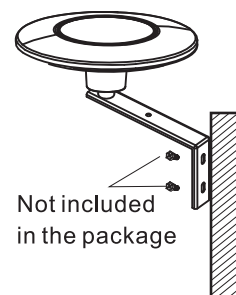

Fig.1



Option 2. Use the deck mount for table stand. The screws included can be used to fix the antenna so it will not move.(Fig.2)

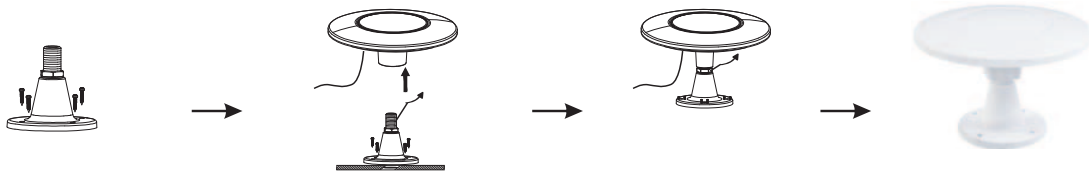

Fig.2

COAX TV CABLE CONNECTION

Connect the “F” male connector of the coaxial cable to the “F” female connector of the antenna, and wear the rubber boot to the end of the connected “F” connector.

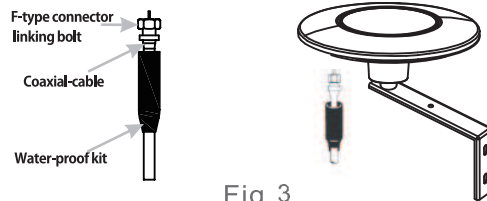

Fig.3

POWER SUPPLY CONNECTION

Connect appropriate cables and wires and tape all the coax connections. Install the power supply unit(Fig.4)

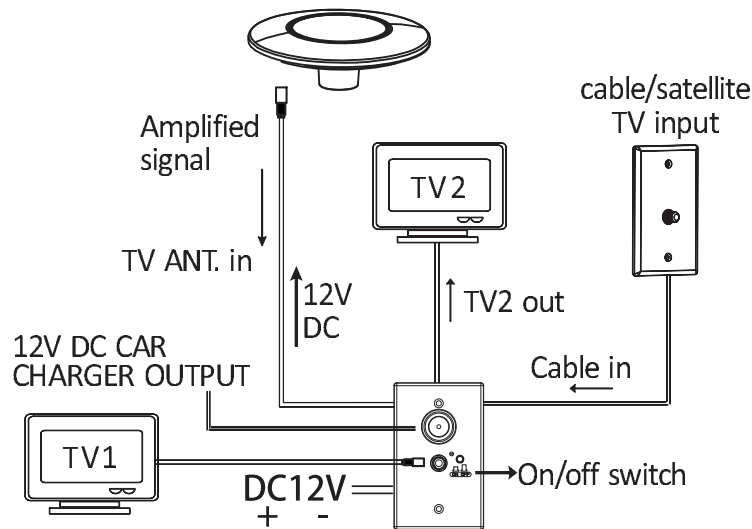
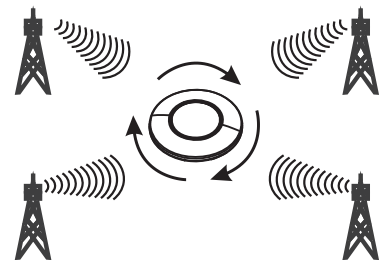

Fig.4

Operation Instruction:

Note: For the best reception, please check the following conditions

1. Keep the antenna away from the sources of interference: keep the antenna away from those big power consumption devices, such as air conditioner, elevator, hair dryer and microwave oven...etc.
2. Install the antenna as high as possible: in digital terrestrial reception, if there are some interceptions between antenna and transmission tower, it will cause the signal loss temporarily. So if the antenna is installed as high as possible, those interceptions will be reduced.



360° OMNI DIRECTION TV SIGNAL reception

Once the antenna and power supply have been installed and all cables have been properly connected, you must run a channel scan before watching TV in order to receive maximum programs. Run a channel scan as once the antenna is moved or the TV loses a channel. Now you can enjoy the TV program after you finish running a channel scan.