

MASTERVOLT

USERS MANUAL / GEBRUIKERSHANDLEIDING / BETRIEBSANLEITUNG
MANUEL UTILISATEUR / MANUAL DE UTILIZACION / INSTRUZIONI PER L'USO

MPPT Solar ChargeMaster 25

BATTERY SOLAR CHARGE REGULATOR



MASTERVOLT
Snijdersbergweg 93
1105 AN Amsterdam
The Netherlands
Tel.: +31-20-3422100
Fax.: +31-20-6971006
www.mastervolt.com

ENGLISH

NEDERLANDS: Zie www.mastervolt.nl/solarchargemaster
DEUTSCH: Siehe www.mastervolt.de/solarchargemaster
FRANÇAIS: Voir www.mastervolt.fr/solarchargemaster
CASTELLANO: Vea www.mastervolt.es/solarchargemaster
ITALIANO: Vedere www.mastervolt.it/solarchargemaster

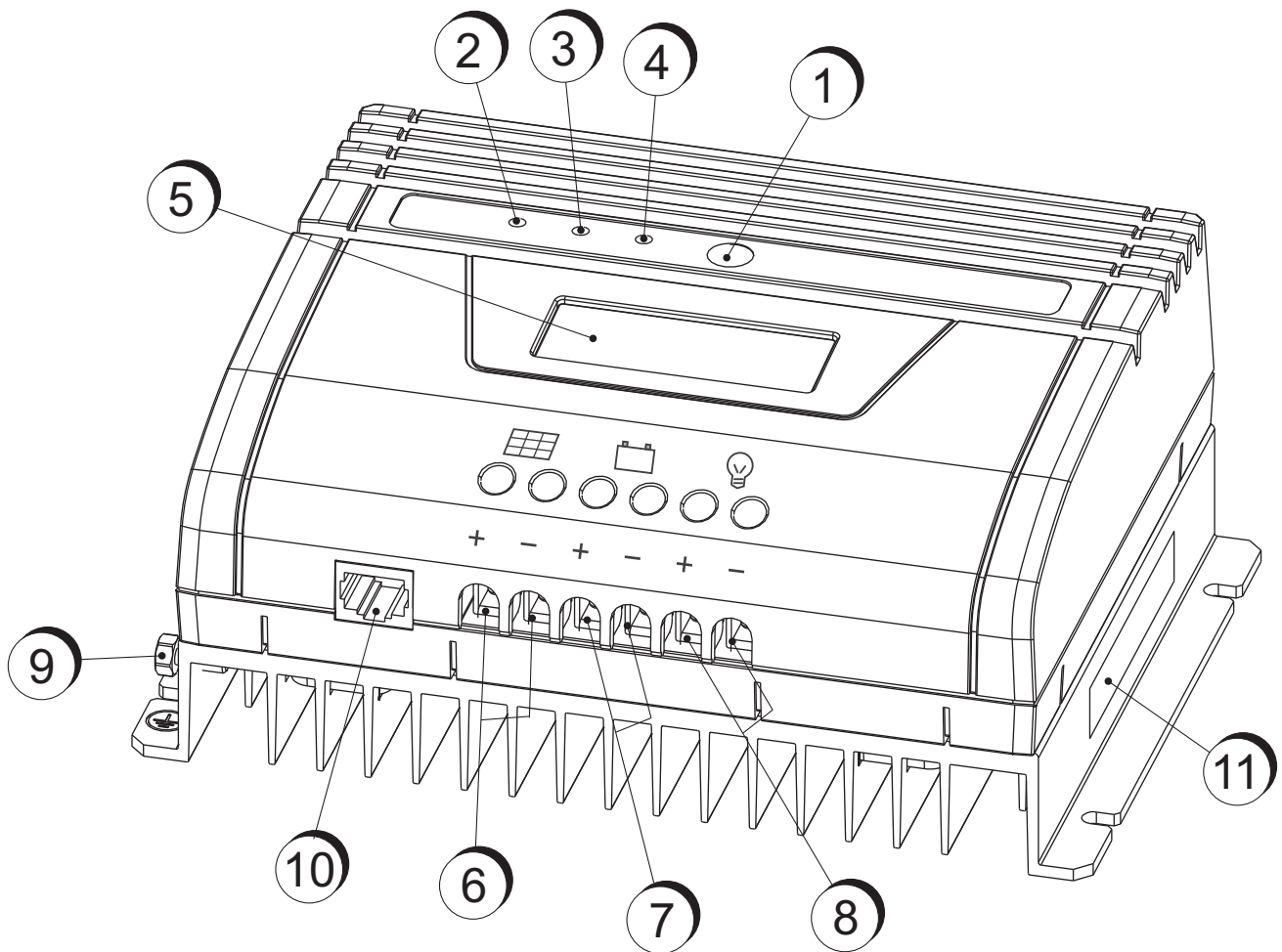
OVERVIEW

1. Power switch (Section 2.5)
2. Solar indicator LED (Section 2.6)
3. Charge indicator LED (Section 2.6)
4. Fault indicator LED (Section 2.6)
5. LCD-display (Section 2.6)
6. PV input
7. Battery connection
8. Load output
9. Grounding terminal
10. Temperature sensor jack
11. Identification label (Section 1.7)

Figure 1: Overview

TABLE OF CONTENTS:

10000009291/00 - March 2015

1	GENERAL INFORMATION.....	4
1.1	Use of this manual.....	4
1.2	Validity of this manual.....	4
1.3	Use of pictograms.....	4
1.4	Identification label.....	4
1.5	Liability.....	4
2	OPERATION.....	5
2.1	General.....	5
2.2	Maintenance.....	5
2.3	Three Step charge algorithm.....	5
2.4	Overview.....	6
2.5	POWER switch.....	6
2.6	LED's and LCD display.....	7
3	INSTALLATION.....	8
3.1	Unpacking.....	8
3.2	Environment.....	8
3.3	Wiring and fuses.....	8
3.4	Specifications of the PV array.....	9
3.5	Connection of loads.....	9
3.6	Things you need.....	11
3.7	Connection.....	11
3.8	Commissioning after installation.....	13
3.9	Use in combination with Mastervolt MLi battery.....	14
3.10	Software version.....	15
3.11	Decommissioning.....	15
3.12	Storage and transportation.....	15
3.13	Re-installation.....	15
4	TROUBLE SHOOTING.....	16
5	TECHNICAL DATA.....	17
5.1	Specifications.....	17
5.2	Dimensions.....	18
5.3	Ordering information.....	18
6	EC DECLARATION OF CONFORMITY.....	19

1 GENERAL INFORMATION

1.1 USE OF THIS MANUAL

This manual serves as a guideline for the safe and effective operation, maintenance and possible correction of minor malfunctions of the Solar ChargeMaster 25.

It is therefore obligatory that every person who works on or with the Solar ChargeMaster must be completely familiar with the contents of this manual and the Important Safety Instructions, and that he/she carefully follows the instructions contained herein.

Installation of, and work on the Solar ChargeMaster 25 may be carried out only by qualified, authorised and trained personnel, consistent with the locally applicable standards and taking into consideration the Important Safety Instructions.

Copyright © 2015 Mastervolt. All rights reserved.
 Reproduction, transfer, distribution or storage of part or all of the contents in this document in any form without the prior written permission of Mastervolt is prohibited

1.2 VALIDITY OF THIS MANUAL

All of the specifications, provisions and instructions contained in this manual apply solely to standard versions of the Solar ChargeMaster delivered by Mastervolt. This manual is only valid for the following models:

Part number	Model
131902500	MPPT Solar ChargeMaster 25

These models are mentioned as "Solar ChargeMaster" further in this manual.

1.3 USE OF PICTOGRAMS

Safety instructions and warnings are marked in this manual and on the product by the following pictograms:



A procedure, circumstance, etc which deserves extra attention.



CAUTION!
 Special information, commands and prohibitions in order to prevent damage.



WARNING
 A WARNING refers to possible injury to the user or installer or significant material damage to the Soladin if the installer / user does not (carefully) follow the stated procedures.



Read this manual before installation and use



This product has been declared conform the EC directives and standards.



Degree of protection: IP23. The product is protected against touch by fingers and water spray < 60 degrees from vertical.

1.4 IDENTIFICATION LABEL

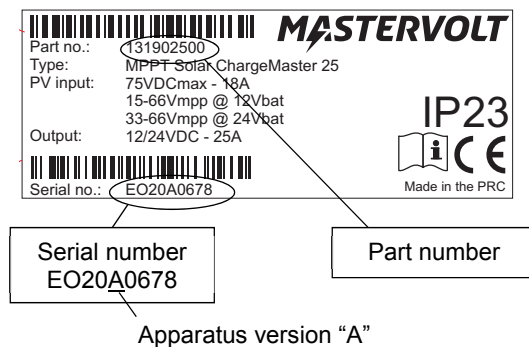

Figure 2: Identification label

The identification label is located at the right-hand side of the Solar ChargeMaster (see Figure 1). Important technical information required for service, maintenance & secondary delivery of parts can be derived from the identification label.



CAUTION!
 Never remove the identification label.

1.5 LIABILITY

Mastervolt can accept no liability for:

- consequential damage due to use of the Solar ChargeMaster;
- possible errors in the manuals and the results thereof.

2 OPERATION

2.1 GENERAL

The Mastervolt Solar ChargeMaster is a fully automatic battery charger which converts power from photovoltaic (PV) array to a regulated battery voltage. The PV array connected to the Solar ChargeMaster is operated at its optimum voltage to obtain an optimal yield (Maximum Power Point tracking). The Solar ChargeMaster will automatically adjust itself to a 12V or a 24V system. Under normal circumstances the Solar ChargeMaster remains switched on with the PV-array and batteries connected.

If power from the PV array is sufficient, the Solar ChargeMaster will initiate the charging process.



WARNING

The Solar ChargeMaster has no on/off switch. Charging will be initiated as soon as power from the PV-array becomes available.

The Solar ChargeMaster is protected against overload, short circuit, overheating and under and over voltage.



CAUTION!

The Solar ChargeMaster is not protected against:

- Excessive overvoltage on the Solar input
- Surges induced by lightning.

2.2 MAINTENANCE

No specific maintenance to the Solar ChargeMaster is required. Examine your electrical installation on a regular base, at least once a year. Defects such as loose connections, burnt wiring etc. must be corrected immediately.

If necessary, use a soft clean cloth to clean the casing of the Solar ChargeMaster. Do not use any liquids or corrosive substances, such as solvents, alcohol, petrol or abrasive components.



In the event of decommissioning, refer to section 3.11

2.3 THREE STEP CHARGE ALGORITHM

See Figure 3. Battery charging is accomplished in three automatic stages: BULK, ABSORPTION and FLOAT.

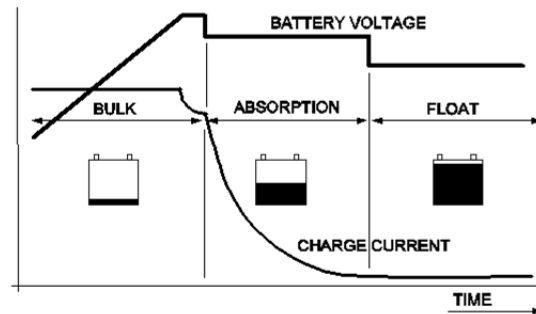

Figure 3: Three step charge system

- BULK: At this stage the charger delivers its maximum current for quick charging from 0 to 80%
- ABSORPTION: The charger has reached its maximum charge voltage and the charge current will slowly decrease until the battery is charged up to 100%.
- FLOAT: This stage begins once the battery is fully charged. The battery remains in fully charged state.

By installing the battery temperature sensor the charge voltages are automatically adapted for deviating temperatures.

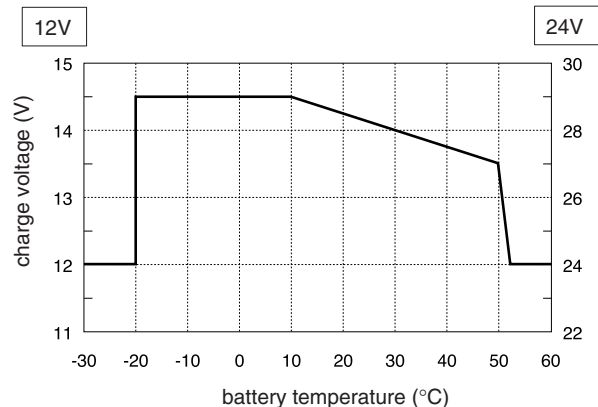

Figure 4: Temperature compensated charging

See Figure 4. When the battery temperature is low, the charge voltage increases. On the other hand, when the battery temperature is high, the charge voltage is decreased. Over charge and gassing are prevented this way. This will extend the life of your batteries.

2.4 OVERVIEW

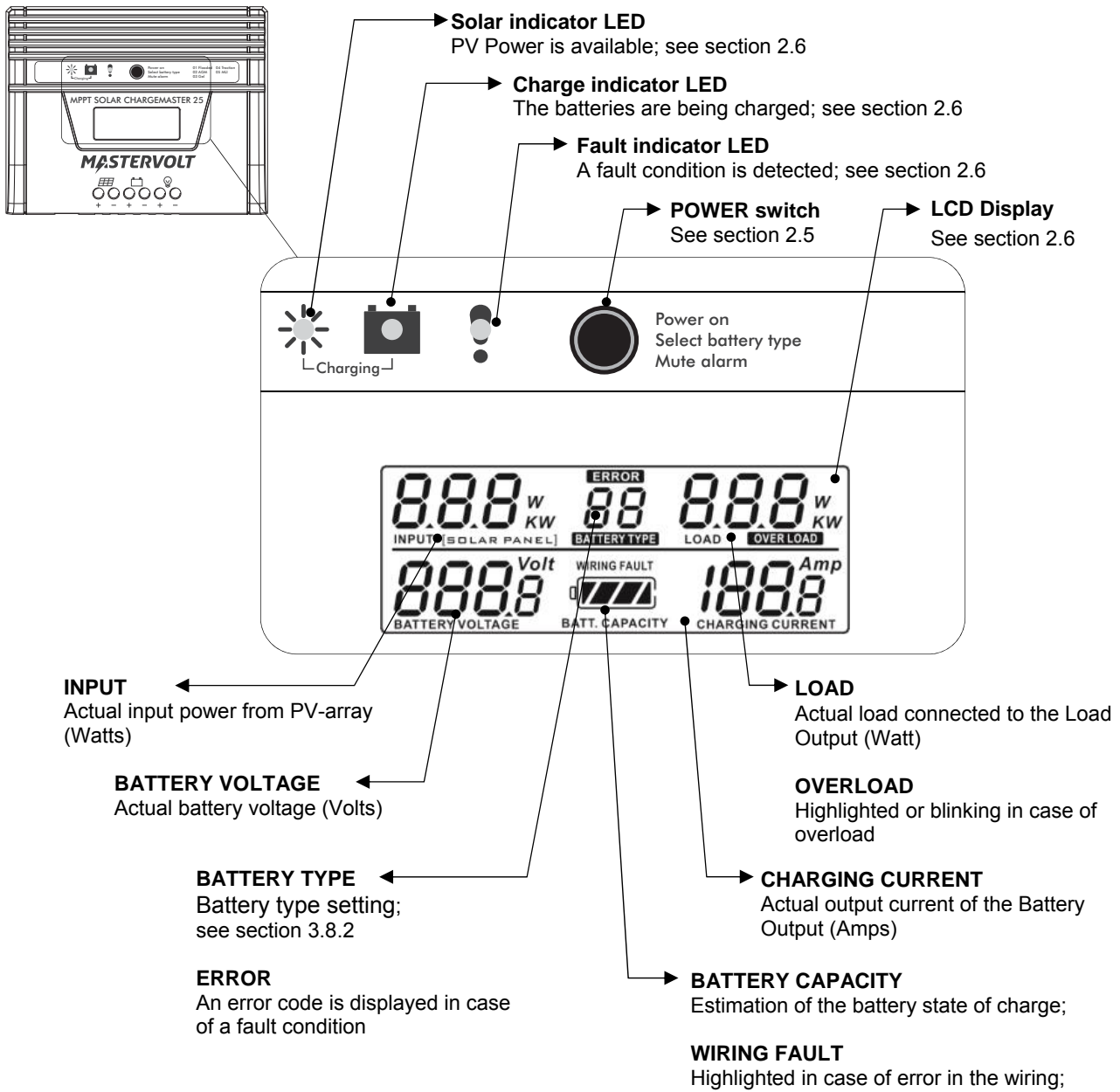





Figure 5: operation of the Solar Chargemaster

2.5 POWER SWITCH

POWER switch operation	Meaning
Press shortly	Activate LCD-display (see text below)
1 second	Switch on Solar Chargemaster again after a fault or error situation
1 second	Mute audible alarm
>5 seconds	Battery type setting, see section 3.8.2

2.6 LED'S AND LCD DISPLAY

LED indication			LCD indication	Audible alarm*	Meaning
					
Blue	Green	(Off)	--	(Off)	Normal operation, batteries are being charged.
(Off)	(Off)	(Off)	(Off)	(Off)	Irradiation on the PV modules is insufficient (for instance during night time). The Solar Chargemaster is in sleep mode to reduce power drain from the batteries. The display can be activated temporarily by pressing the POWER switch shortly. The display will be deactivated automatically after 1 minute.
(Off)	(Off)	(Off)	(Off)	(Off)	No power from the PV-modules. Check wiring to PV-modules if the Solar Chargemaster is switched off during daytime. Check for loose connections or incorrect polarity.
(Off)	(Off)	Yellow	--	(Off)	Reversed polarity on the PV-input. Check PV array wiring.
(Off)	(Off)	Red	--	(Off)	Reversed polarity on the Battery connection. Check battery wiring.
(Off)	(Off)	Orange	--	(Off)	Reversed polarity on the PV-input and Battery connection. Check wiring.
--	--	--	OVERLOAD blinking	Every 2 seconds	Overload on Load output (110%). Reduce connected load.
--	--	--	 blinking	Every second	Low battery voltage. Reduce load connected to the batteries and charge batteries.
--	--	--	F0	Continuously	Power from PV-modules is OK, but battery voltage too low (< 8.5V @ 12V / <17V @ 24V). Check batteries.
--	--	--	F1	Continuously	Overcharge, battery voltage is too high. The charger will automatically cut off output. Check batteries.
--	--	--	F2 + OVERLOAD	Continuously	Overload on Load output (130%). The charger will automatically cut off the output. Reduce connected load.
--	--	--	E1 + ERROR	Continuously	Voltage from PV-modules is too high. Check PV-array.
--	--	--	E2 + ERROR	(Off)	MLi Ultra battery only: <i>Stop charge event</i> generated. Refer to user's manual of the MLi Ultra battery.
--	--	--	E3 + ERROR	Continuously	Battery temperature too high. Check batteries.
--	--	--	E4 + ERROR	Continuously	Battery temperature too low. Check batteries.

* The audible alarm can be muted by holding the POWER switch pressed for 1 second.

** Refer to section 3.8.2 for battery type settings.

3 INSTALLATION

During installation commissioning and maintenance of the Solar ChargeMaster, the Important Safety Instructions are applicable at all times.

3.1 UNPACKING

The delivery includes the following items:

- Solar Chargemaster;
- Battery temperature sensor;
- Modular cable assembly (see section 3.9);
- This User's manual
- Important Safety Instructions

After unpacking, check the contents for possible damage. Do not use the product if it is damaged. If in doubt, contact your supplier.

3.2 ENVIRONMENT

Obey the following stipulations during installation:

- The Solar Chargemaster is designed for indoor use only.
- Ambient operating temperature: -20°C ... 55°C / -4°F ... 131°F (power de-rating above 40°C / 104°F to decrease the internal temperature).
- Humidity: 5-95%, non-condensing.
- The Solar ChargeMaster must be mounted to a vertical, solid and heat-resistant surface, with the connecting cables downwards.
- Do not expose the Solar Chargemaster to excessive dust, aggressive environments, ammonia or salt.
- Make sure that the hot air that is developed during operation can be discharged. The Solar Chargemaster must be mounted in such a way that obstruction of the airflow along the heatsink on the backside of the casing will be prevented.
- No objects must be located within a distance of 20 cm / 8 inch around the Solar Chargemaster.
- Do not locate the Solar Chargemaster in the same compartment as the batteries.
- Do not install the Solar Chargemaster straight above the batteries because of possible corrosive sulphur fumes.
- Although the Solar Chargemaster fully complies with all applicable EMC limits, it may still cause harmful interference to radio communication equipment. If such interference appears, it is recommended to increase the separation between the Solar Chargemaster and the equipment, to relocate the receiving antenna or to connect the equipment to a circuit different from that to which the Solar Chargemaster is connected.

3.3 WIRING AND FUSES



WARNING

The wire and fuse sizes stated in this manual are given as example only. Prescribed wire and fuse sizes may be different due to local applicable regulations and standards.

Keep in mind that high current will pass through the DC wiring. Keep the cable length as short as possible, this will keep the system efficiency as high as possible. The recommended minimum cross sections of the wiring are:

Connection	Minimum DC Cable cross section	
	<2m / 6ft length	2 - 4m / 6 - 12ft
PV input	6mm ² / AWG10	10mm ² / AWG8
Battery	6mm ² / AWG10	10mm ² / AWG8
Load	6mm ² / AWG10	10mm ² / AWG8

Use boot lace ferrules on the wire ends. These ferrules must be crimped with a proper crimping tool.

Use the following wire colours for DC wiring:

Wire colour	Meaning	Connect to:
Red	Positive	+ (POS)
Black	Negative	- (NEG)

Lay the positive and negative cables next to each other to limit the electromagnetic field around the cables. The negative battery cable should be connected directly to the negative post of the battery bank or the ground side of a current shunt. Do not use the chassis frame as the negative conductor. Tighten securely. The positive battery cable must be fused and connected to the positive post of the battery bank.

The recommended DC fuses are:

Connection	DC fuse
Battery fuse	40A
Load fuse	40A

See section 5.3 for ordering information

3.4 SPECIFICATIONS OF THE PV ARRAY



WARNING

When the PV array is exposed to light, it supplies a DC voltage to the Solar Chargemaster which can be dangerous to touch. For this reason, use of an external DC-switch is strongly recommended. Alternatively, before attempting any maintenance or cleaning the PV-array should be protected from light exposure, e.g. by covering the PV modules.



CAUTION!

Do not connect Solar Chargemasters in parallel on the side of the PV array.

The Solar Chargemaster can be used with any PV array configuration that satisfies the following requirements:

- Maximum open circuit PV voltage: 75 V DC;
- The open circuit voltage from the PV array must be 5Volts higher than the battery voltage.



CAUTION!

Never connect voltages higher than specified to the PV-input, as this will cause permanent damage to the Solar Chargemaster.

Configuration examples for PV-arrays consisting of monocrystalline or polycrystalline PV-modules:

Battery voltage $U_{NOM} = 12V$		
Panel type	Number of panels	
	in series	parallel
36 cells	1 up to 3	Max. 360Wp
60 cells	1	Max. 360Wp
72 cells	1	Max. 360Wp

Battery voltage $U_{NOM} = 24V$		
Panel type	Number of panels	
	in series	parallel
36 cells	2 up to 3	Max. 720Wp
60 cells	1	Max. 720Wp
72 cells	1	Max. 720Wp



NOTE:

The Solar Chargemaster will automatically limit the input current and power to its specified rating (see section 5.1). Excess power will not be converted.

3.5 CONNECTION OF LOADS

Depending on the energy system in which the Solar Chargemaster is used, there are two options to connect the electrical load to the Solar Chargemaster:

- To the Load output on the Solar Chargemaster, or
- Directly to the battery.

3.5.1 Load connected to the Load output

See Figure 6 for a typical installation diagram. The Load output is provided with a protection circuit that switches off the connected load automatically in case of overload or if the battery voltage is too low. This kind of installation is typically used when the PV-modules are the only source of electrical power to charge the battery.

Characteristics:

- Maximum DC-load: 25A
- Under voltage disconnect: 10.5V
- Under voltage reconnect: 11.0V

3.5.2 Load connected to the battery

If the maximum load will exceed 25 Amps or if the battery will also be charged by other energy sources, such as a battery charger or an alternator, the electrical load shall be connected to the battery directly. See Figure 7 for a typical installation diagram. In this situation the battery is no longer protected against too low battery voltages. Installation of additional undervoltage protection circuits may be necessary. See section 5.3 for ordering information.

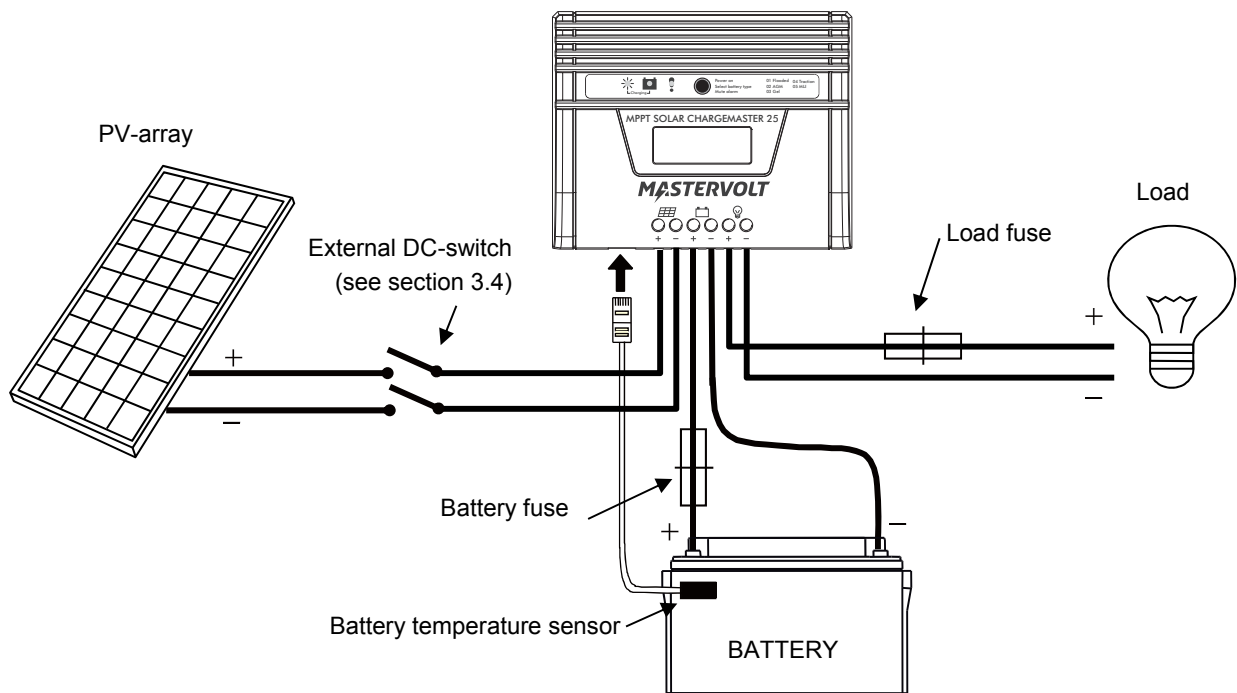

Figure 6: Load connected to the Load output on the Solar Chargemaster

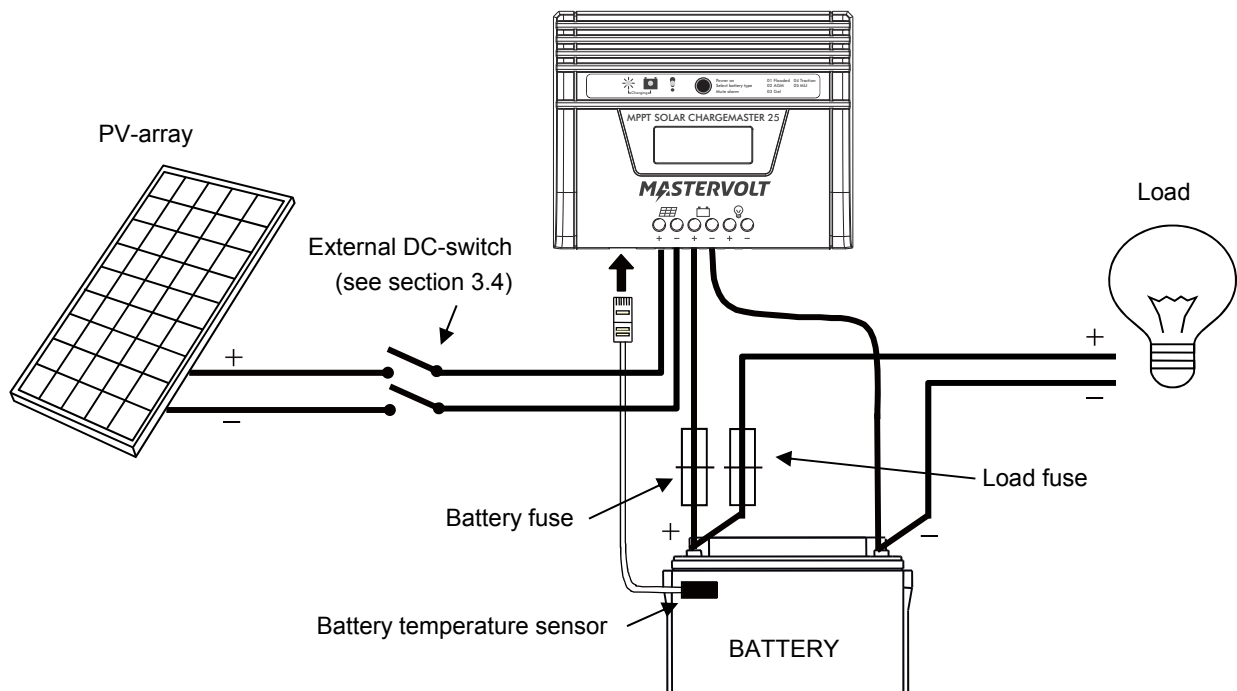

Figure 7: Load connected directly to the battery

Above schematics are to illustrate the general placement of the Solar Chargemaster in a circuit. They are not meant to provide detailed wiring instructions for any particular electrical installation.

3.6 THINGS YOU NEED

Make sure you have all the parts you need to install the Solar Chargemaster:

- Solar Chargemaster (included);
- Battery temperature sensor with cable and plug (included);
- DC cables to connect the Solar Chargemaster; see section 3.3 for specifications;
- DC-fuse holder with a DC-fuse, to be integrated in the positive DC-cable to the battery; see section 3.3
- Screws / bolts (Ø 4mm max.) (with plugs) to mount the Solar Chargemaster to a surface;
- Batteries;
- Appropriate and reliable cable terminals, strain reliefs, battery terminals and boot lace ferrules.

We recommend as a minimum tool kit:

- Phillips screw driver nr.2 or flat blade screw driver 5 mm to fix the DC-cables;
- Tools to fix the screws / bolts with plugs to mount the Solar Chargemaster to a surface;

3.7 CONNECTION

3.7.1 General



WARNING

Let installation work be done by a licensed electrician.

All electrical systems must be disconnected from any power source during the entire installation!



CAUTION!

- Short circuiting or reversing DC polarity may lead to damage to the Solar Chargemaster, the cabling and/or the terminal connections.
- Follow all steps of the installation instructions in order of succession as described.



CAUTION!

Too-thin cables and/or loose connections can cause dangerous overheating of the cables and/or terminals. Therefore tighten all connections well, in order to limit transition resistance as far as possible. Use cables of the correct size. Use additional strain reliefs to prevent the transmission of stress to the screw connectors.



CAUTION!

The negative connections of the Solar ChargeMaster are common and therefore have the same electrical potential. If grounding is required, always do this on the negative wires. Use one grounding point only.



NOTE:

If the battery temperature remains within 15-25°C, connection of the battery temperature sensor is optional.

3.7.2 Installation step by step

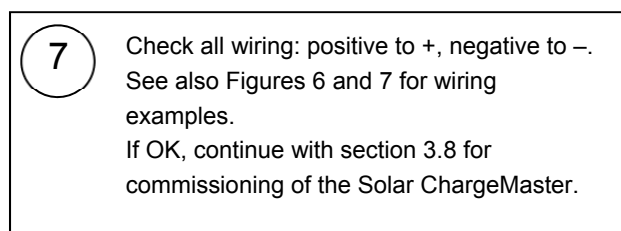
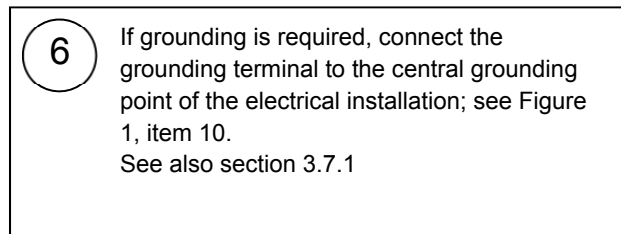
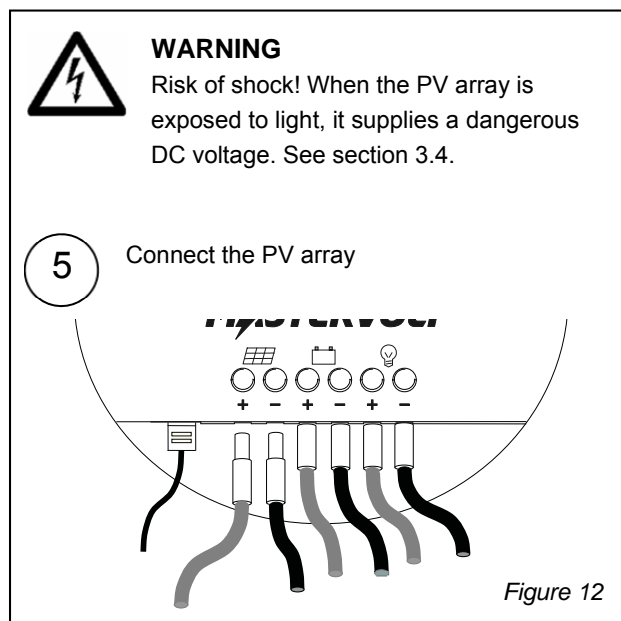
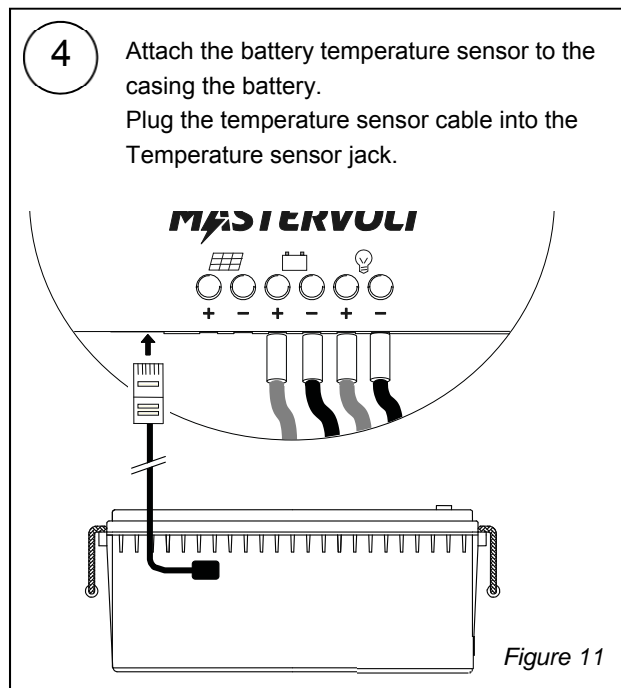
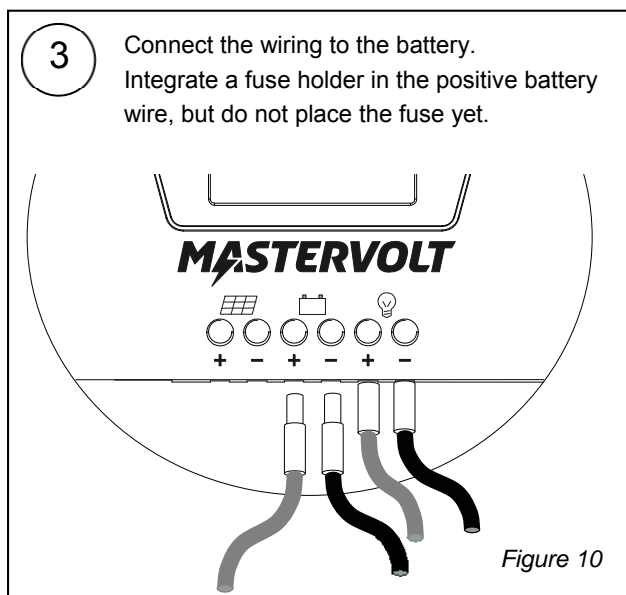
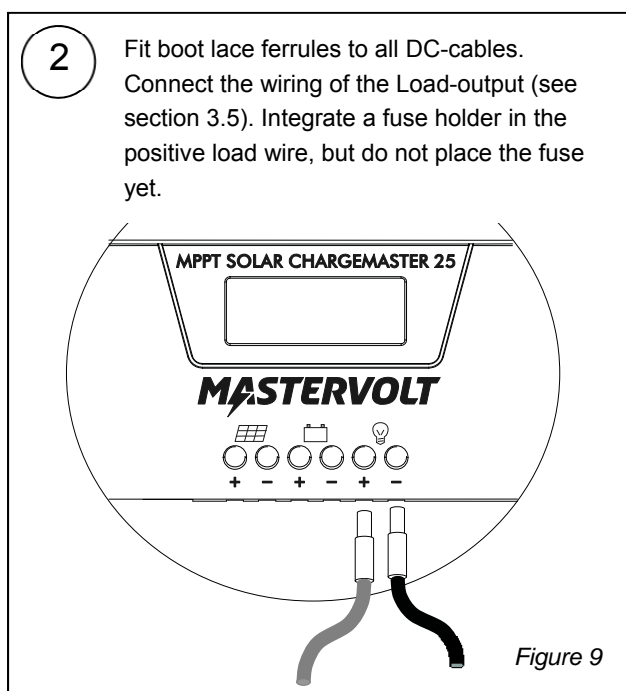
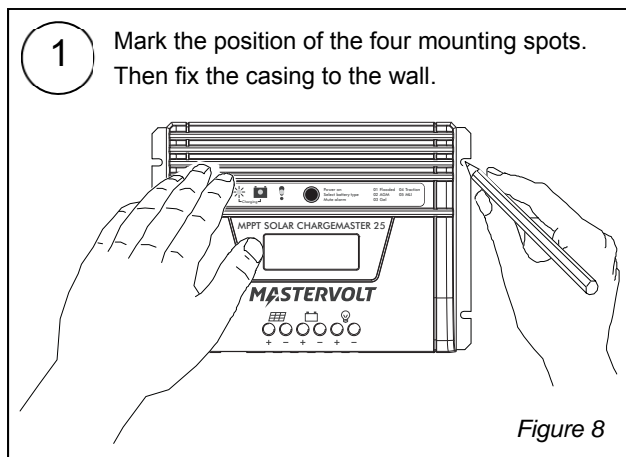

3.8 COMMISSIONING AFTER INSTALLATION

3.8.1 Commissioning step-by-step



CAUTION!

Check the polarity of all wiring before commissioning: positive connected to positive (red cables), negative connected to negative (black cables).

- 1 If all wiring is OK, place the DC-fuse between the Solar Chargemaster and the load.
- 2 Then place the DC-fuse between the Solar Chargemaster and the battery.



WARNING

When placing this fuse, a spark can occur, caused by the capacitors used in the Solar Chargemaster. This is particularly dangerous in places with insufficient ventilation, due to the gassing of the batteries an explosion can occur. Avoid having flammable materials close by.

- 3 The Solar Chargemaster will initiate the charging process if the voltage from the PV array is 5VDC higher than the battery voltage; see chapter 2.



If the Solar Chargemaster does not switch on, press the POWER switch for 1 second.

3.8.2 Battery type setting

The Solar ChargeMaster is suitable for charging the following battery types: Flooded lead acid, AGM, Spiral, Gel, Traction batteries and Mastervolt Li-Ion batteries (MLi).



WARNING

The MLi charging voltages on this charger fit the Mastervolt Li-ion (MLi) batteries but do not necessarily fit other Li-ion batteries!. See also section 3.9. Always follow the instructions provided by the battery manufacturer!



CAUTION!

Invalid settings of the Solar ChargeMaster can cause serious damage to your batteries and/or the connected load! Adjustments of settings may be undertaken by authorised personnel only.



If your Solar Chargemaster is not new, you have to take into account that former users may have changed the settings.

The actual setting for Battery type is shown on the display during normal operation mode. See Figure 13.

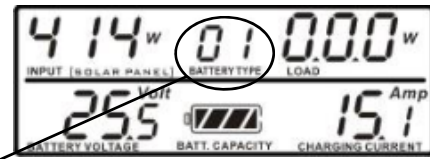

Indication	Battery type
01	Flooded
02	AGM
03	Gel
04	Traction
05	Mastervolt MLi (see section 3.9)

Figure 13: Battery type setting

To change the Battery type setting:

- Hold the POWER button (Figure 1) pressed until the Battery type indication starts blinking;
- Press the POWER button shortly to scroll through the Battery type settings as described above;
- Hold the POWER button pressed until the Battery type indication stops blinking to confirm the desired setting.

When the POWER button is not touched during 10 seconds, the Solar Chargemaster will return to the normal operation mode without changing a setting.

3.9 USE IN COMBINATION WITH MASTERVOLT MLI BATTERY

If the Solar Chargemaster is used to in combination with a Mastervolt MLI Ultra type Li-ion battery, charging shall switch to the float stage if the MLI Ultra battery generates the *Stop charge event*.

Additional things you need:

- MasterBus Multipurpose Contact Output (see section 5.3 for ordering information);
- Modular cable assembly (included in the delivery of the Solar Chargemaster);

Follow next additional steps to install the Solar Chargemaster in combination with a Mastervolt MLI type Li-ion battery (see Figure 14):

- 1 Do not use the battery temperature sensor. Instead plug the loose provided modular cable assembly into the Temperature sensor jack;

- 2 Connect the other side of this cable assembly to the Multipurpose Contact Output as indicated;
- 3 Connect the DC main wiring and other components as indicated;
- 4 Connect the MasterBus cabling between the devices as indicated;
- 5 Add a MasterBus control panel to the MasterBus network;
- 6 Configure the following *Stop Charge event* at the Li-ion battery:

Configuration	Event 1 (obligatory)
Event source	Stop Charge
Event target	INT DC Relay
Event command	Activate
Event data	Copy

- 7 Adjust setting for Battery type to Mastervolt MLI (see section 3.8.2);
- 8 Continue with the “Commissioning” section in the manual of the MLI Ultra battery.

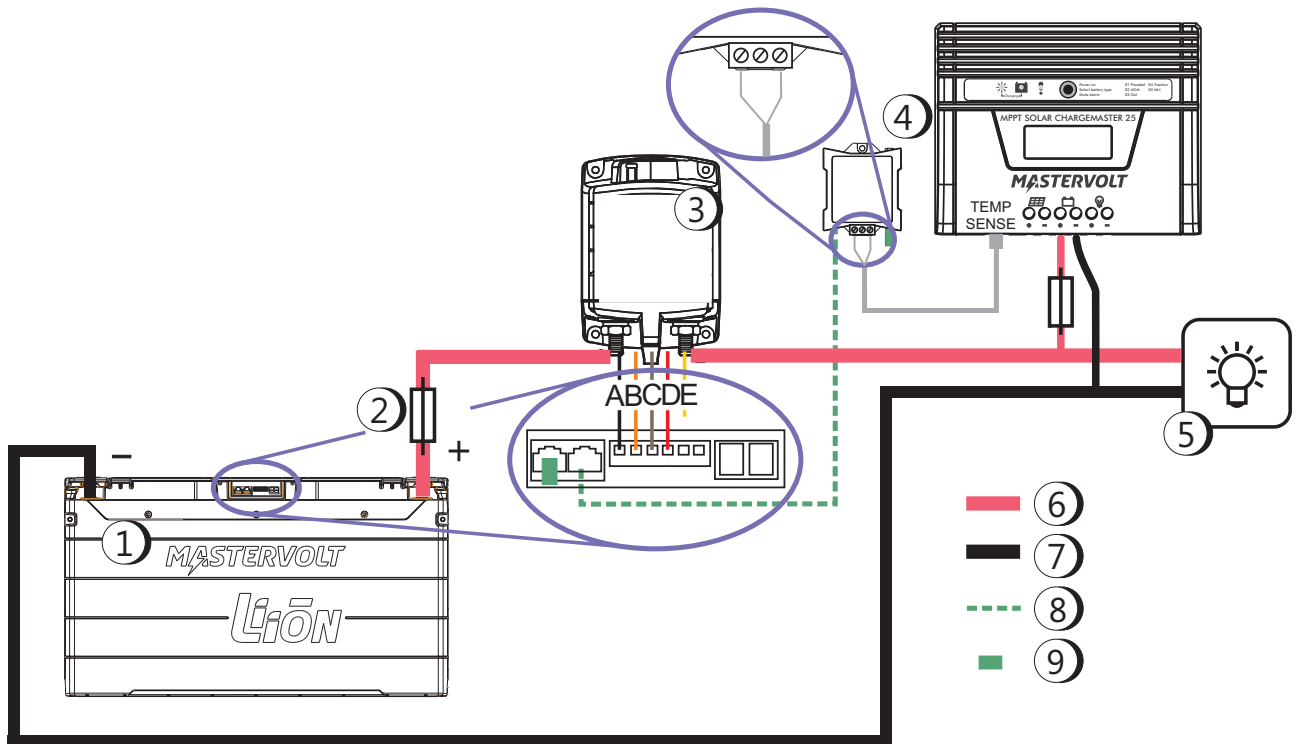

- | | |
|---|-------------------------|
| 1. Li-ion battery | 5. Loads |
| 2. Battery fuse in positive battery line | 6. DC positive cable |
| 3. Safety relay | 7. DC negative cable |
| 4. MasterBus Multipurpose Contact Output via modular cable assembly connected to the Solar Chargemaster | 8. MasterBus cable |
| | 9. MasterBus terminator |

Figure 14: Use of the Solar ChargeMaster in combination with a Mastervolt MLI Ultra battery

3.10 SOFTWARE VERSION

To check the version of the installed software:

- Hold the POWER button (Figure 1) pressed until the Battery type indication starts blinking;
- The version of the installed software is shown at the right upper side of the display (Figure 15);
- After 10 seconds the Solar Chargemaster returns to the normal operation mode.

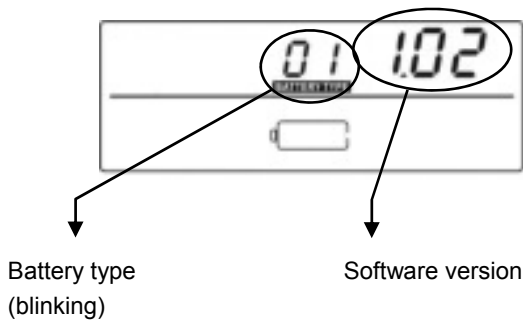

Figure 15: Software version

3.11 DECOMMISSIONING

To put the Solar ChargeMaster out of operation, follow these instructions in order of succession:

- 1 Switch off all loads that are connected to the Solar Chargemaster;
- 2 Disconnect the PV array by switching off the switch between the PV-array and the Solar Chargemaster (or protect the PV-array from light exposure, e.g. by covering the PV modules);
- 3 Remove the DC-fuse between the Solar Chargemaster and the battery;
- 4 Remove the DC-fuse between the Solar Chargemaster and the load;
- 5 Check with a suitable voltage meter whether the Battery connection and the LOAD output of the Solar Chargemaster are voltage free;
- 6 Disconnect the negative cable to the PV array from the terminal block of the Solar Chargemaster. Isolate the core of the wire with insulating tape;
- 7 Do the same for the positive cable to the PV array;
- 8 Disconnect all other remaining wiring.

Now the Solar Chargemaster can be demounted in a safe way.

3.12 STORAGE AND TRANSPORTATION

When not installed, store the Solar Chargemaster in the original packing, in a dry and dust free environment.

Always use the original packing for transportation. Contact your local Mastervolt Service Centre for further details if you want to return the apparatus for repair.

3.13 RE-INSTALLATION

To reinstall the Solar Chargemaster, follow the instructions as described in this chapter (chapter 3).

4 TROUBLE SHOOTING

If you cannot solve a problem with the aid of this chapter, contact your local Mastervolt Service Centre. See www.mastervolt.com/technical-support. Make sure you have the following information present if you have to contact your local Mastervolt Service Center to solve a problem:

- Article and serial number; see section 1.4
- Software version; see section 3.10

Malfunction	Possible cause	What to do
No output voltage and/or current	Solar Chargemaster was switched off due to a previous fault situation	Press POWER-button for one second to switch on the Solar Chargemaster again
	Check section 2.6 for an overview of fault indications of the LED's and the LCD display	
Display shows OVERLOAD or error code E1, E2, E3, E4, F0, F1 or F2	Check section 2.6 for an overview of fault indications of the LED's and the LCD display	
Fault indicator LED illuminated	Check section 2.6 for an overview of fault indications of the LED's and the LCD display	
Audible alarm active	Press POWER switch for 1 second to mute the alarm. Check section 2.6 for an overview of fault indications of the LED's and the LCD display	
No display	The Solar Chargemaster is in sleep mode	Press the POWER switch shortly to activate the display
Output voltage too low, charger supplies maximum current	Load that is connected to the batteries is larger than charger can supply.	Reduce load taken from the batteries.
	Batteries not 100% charged	Measure battery voltage. After some time this will be higher.
	Wrong battery type setting	Check settings (see section 3.8.2).
Charge current too low	Batteries almost fully charged	Nothing, this is normal when the battery is almost fully charged.
	High ambient temperature	Nothing; if ambient temperature is above 40°C / 104°F the charge current is automatically reduced.
	Low irradiation on the PV-array.	Check PV-array, check for shading.
Battery not fully charged	Current to load is too high	Reduce load taken from the batteries.
	Charge time too short	Use an additional battery charger
	Battery temperature too low	Use the battery temperature sensor.
	Defective or worn-out battery	Check battery and replace if necessary.
	Wrong battery type setting	Check settings (see section 3.8.2).
Battery is discharged too fast	Battery capacity reduced due to sulphation or due to plate corrosion	Charge and recharge a few times, this might help. Check battery and replace if necessary.
Batteries are too warm, gassing	Defective battery (short circuit in cell)	Check battery and replace if necessary.
	Battery temperature too high	Use the battery temperature sensor.
	Wrong battery type setting	Check settings (see section 3.8.2).

5 TECHNICAL DATA

5.1 SPECIFICATIONS

Model	MPPT Solar ChargeMaster 25	
Article no.	131902500	
Nominal battery voltage (U _{NOM})	12V and 24 V (Auto detection)	
PV-INPUT	@ U_{NOM} = 12V	@ U_{NOM} = 24V
Maximum connected PV power	360Wp	720Wp
Maximum input PV power*	300W	600W
Full power voltage MPPT range	15 V ~ 66 V	30 V ~ 66 V
Absolute maximum PV Voltage	50V _{DC}	75V _{DC}
MPP tracking	Yes, integrated MPP tracker	
Start-up voltage:	Battery voltage + 3V _{DC}	
Maximum PV input current	18A _{DC}	
EU efficiency	>97%	
Peak static power conversion efficiency	>98%	
Static MPPT efficiency	>99%	
BATTERY OUTPUT	@ U_{NOM} = 12V	@ U_{NOM} = 24V
Maximum charge current (I _{MAX})	25 A	25 A
Charge voltage, Absorption:	14.25V (Traction: 14.45V)	28.5V (Traction: 28.9V)
Charge voltage, Float:	13.25V (AGM, gel: 13.8V, MLI: 13.5V)	26.5V (AGM, gel: 27.6V, MLI: 27.0V)
Battery temperature compensation	-30 mV/°C	-60 mV/°C
DC consumption (at night):	5mA	5mA
DC consumption (on, no charging):	<110mA	<80mA
Charge algorithm:	Three step (Bulk, Absorption, Float)	
Battery types**:	Flooded, AGM, Gel, Traction, Mastervolt MLI.	
LOAD OUTPUT	@ U_{NOM} = 12V	@ U_{NOM} = 24V
Maximum output current	25 A, max 36A peak for 1 sec.	25 A, max 36A peak for 1 sec.
Under voltage disconnect	10.5V	21.0V
Under voltage reconnect	11.0V	22.0V
GENERAL		
Galvanic isolation between PV and battery	No, common negative conductor	
Dimensions in mm [inch] (h x w x d):	135 x 190 x 73 mm [5.3 x 7.5 x 2.9 inch]; see also section 5.2	
Weight:	1 kg	
Operating Temperature Range	-20°C ≤ T _{AMB} ≤ +55°C [-4°F ≤ T _{AMB} ≤ 131°F]	
Full Power Temperature range	-20°C ≤ T _{AMB} ≤ +40°C [-4°F ≤ T _{AMB} ≤ 104°F] (no power de-rating)	
Non-operating Temperature range	-40°C ≤ T _{AMB} ≤ +75°C [-4°F ≤ T _{AMB} ≤ 167°F] (storage temperature)	
Relative Humidity	5% to 95% non-condensing	
Protection degree	IP23	
MasterBus connectivity	No	
Terminals:	Screw terminals, max. wire size 10mm ²	

* Automatic limitation of input power; excessive power will not be converted

** Refer to section 3.8.2 for battery type settings.

Specifications are subject to change without prior notice.

5.2 DIMENSIONS

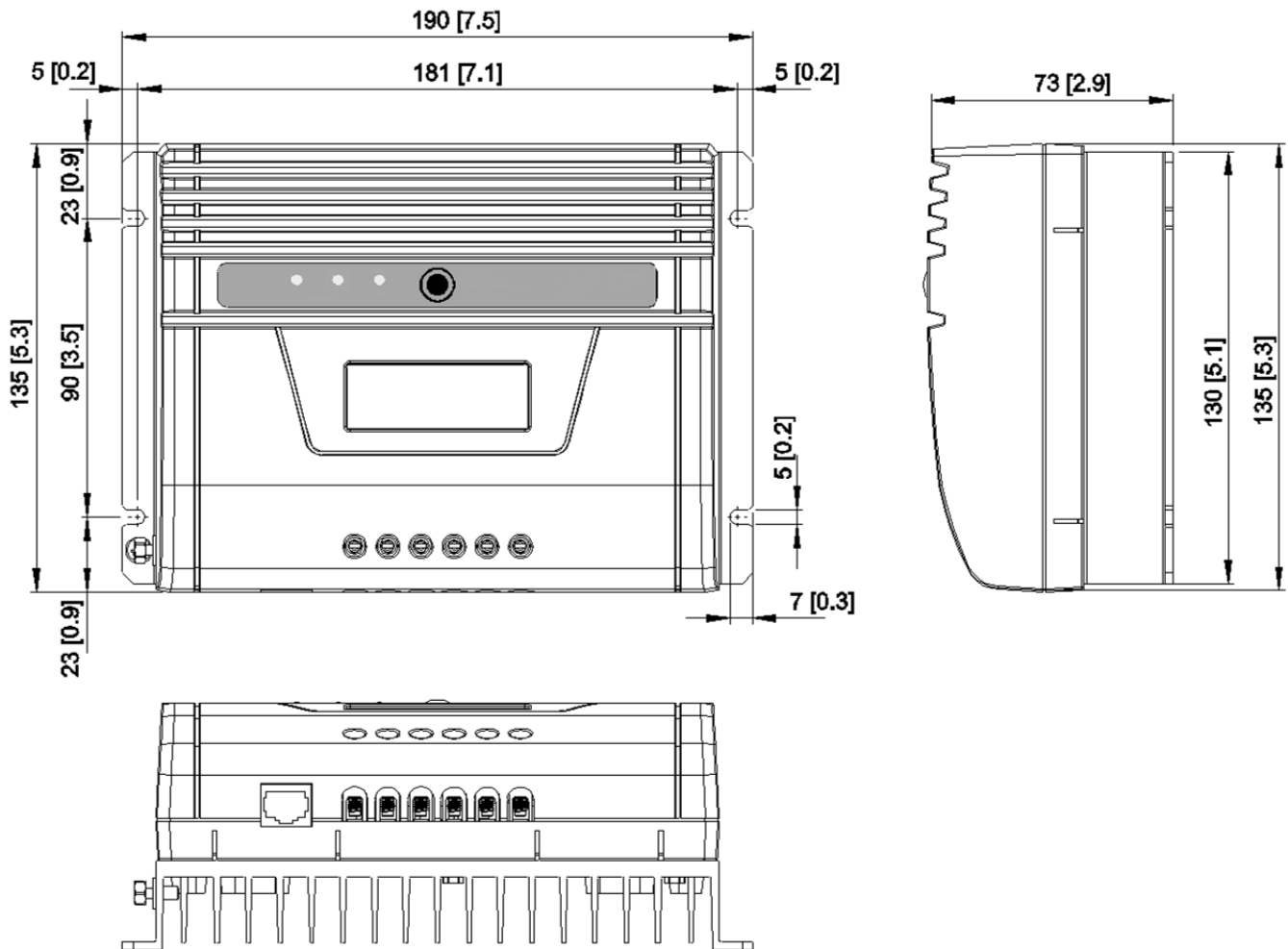

Figure 16: Dimensions of the Solar ChargeMaster in mm [inches]

5.3 ORDERING INFORMATION

Part number	Description
77049040	ANL Fuse 40A
607006	ANL Fuse block
701	Battery switch 275A
41500500*	Battery temperature sensor, incl. 6 meter / 19 ft cable
---*	Modular cable assembly (see section 3.9)
77030500	MasterBus Multipurpose Contact Output (see section 3.9)
83200150	Battery Watch, Battery undervoltage protection circuit, 12V/24V, 100A continuous, 150A peak load
77020200	DC-Distribution 500.

The Mastervolt DC Distribution offers fused DC connections to install up to four different devices.

* standard included with the delivery of the Solar Chargemaster

Mastervolt can offer a wide range of products for your electrical installation, including battery chargers, DC to AC Sine wave inverters, AGM, gel and Li-ion batteries, DC distribution kits and many more.

See our website www.mastervolt.com for an extensive overview of all our products.

6 EC DECLARATION OF CONFORMITY

We,
Manufacturer Mastervolt
Address Snijdersbergweg 93
 1105 AN Amsterdam
 The Netherlands



Declare under our sole responsibility that product

131902500 MPPT Solar ChargeMaster 25

Is in conformity with the provisions of the following EC directives:

2006/95/EC (Low voltage directive); the following harmonized standards have been applied:

- EN 60335-1: 2012 Household and similar electrical appliances - Safety - Part 1: General requirements
- EN 60335-2-29: 2004 Household and similar electrical appliances - Safety -- Part 2-29: Particular requirements for battery chargers

2004/108/EC (EMC directive); the following harmonized standards have been applied:

- EN 61000-6-3: 2007 + A1:2011 Emission for residential, commercial and light-industrial environments
- EN 61000-6-1: 2007 Immunity for residential, commercial and light-industrial environments

2011/65/EU (RoHS directive)

Amsterdam, 16 January 2015

A handwritten signature in black ink, appearing to read 'H.A. Poppelier', is written over a horizontal dashed line.

H.A. Poppelier
Manager New Product Development

MASTERVOLT
THE POWER TO BE INDEPENDENT

Snijdersbergweg 93, 1105 AN Amsterdam, The Netherlands

Tel : + 31-20-3422100

Fax : + 31-20-6971006

Email : info@mastervolt.com