

Smart choice for power™

**xantrex™**

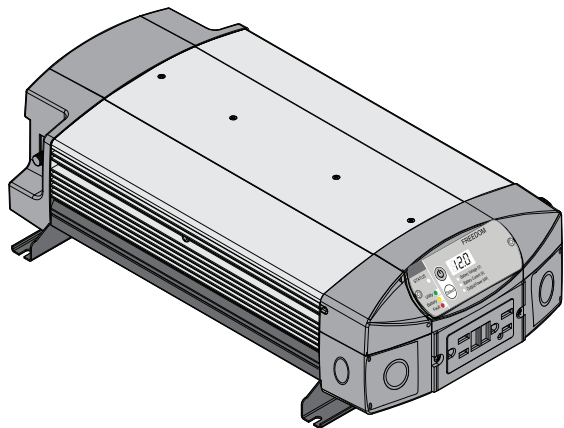

Product image shown may vary from actual product. See features for comparisons.

# Freedom Xi Inverter

## Owner's Guide

Model Product Number

807-1000

807-2000



Copyright © 2015 Schneider Electric. All Rights Reserved. All trademarks are owned by Schneider Electric Industries SAS or its affiliated companies.

## Exclusion for Documentation

UNLESS SPECIFICALLY AGREED TO IN WRITING, SELLER

(A) MAKES NO WARRANTY AS TO THE ACCURACY, SUFFICIENCY OR SUITABILITY OF ANY TECHNICAL OR OTHER INFORMATION PROVIDED IN ITS MANUALS OR OTHER DOCUMENTATION;

(B) ASSUMES NO RESPONSIBILITY OR LIABILITY FOR LOSSES, DAMAGES, COSTS OR EXPENSES, WHETHER SPECIAL, DIRECT, INDIRECT, CONSEQUENTIAL OR INCIDENTAL, WHICH MIGHT ARISE OUT OF THE USE OF SUCH INFORMATION. THE USE OF ANY SUCH INFORMATION WILL BE ENTIRELY AT THE USER'S RISK; AND

(C) REMINDS YOU THAT IF THIS MANUAL IS IN ANY LANGUAGE OTHER THAN ENGLISH, ALTHOUGH STEPS HAVE BEEN TAKEN TO MAINTAIN THE ACCURACY OF THE TRANSLATION, THE ACCURACY CANNOT BE GUARANTEED. APPROVED CONTENT IS CONTAINED WITH THE ENGLISH LANGUAGE VERSION WHICH IS POSTED AT WWW.XANTREX.COM.

## Document Part Number

975-0754-01-01

## Date and Revision

September 2015 Rev A

## Product Numbers

807-1000 (Freedom Xi 1000 120VAC)

807-2000 (Freedom Xi 2000 120VAC)

## Contact Information

Telephone: +1 800 670 0707

+1 408 987 6030

Web: [www.xantrex.com](http://www.xantrex.com)

## Information About Your System

As soon as you open your product, record the following information and be sure to keep your proof of purchase.

Serial Number \_\_\_\_\_

Product Number \_\_\_\_\_

Purchased From \_\_\_\_\_

Purchase Date \_\_\_\_\_

*To view, download, or print the latest revision, visit the website shown under Contact Information.*

# About This Guide

## Purpose

The purpose of this Owner's Guide is to provide explanations and procedures for operating, maintaining, and troubleshooting a Freedom Xi Sine Wave Inverter for Recreational, Fleet Vehicle, or Marine installations. For complete information to help in installing a Freedom Xi Sine Wave Inverter see the Freedom Xi Sine Wave Inverter Installation Guide (Doc. Part Number: 975-0753-01-01).

## Scope

The Guide provides safety and operating guidelines as well as information on configuring the Inverter. It also provides information about troubleshooting the unit. It does not provide details about particular brands of batteries. You need to consult individual battery manufacturers for this information.

## Audience

The Guide is intended for users and operators of the Freedom Xi Sine Wave Inverter.

## Abbreviation or Acronym

A	Amps
AC	Alternating Current
DC	Direct Current
ft-lbs	Foot-pounds (a measure of torque)
kW	Kilowatts (1000 watts)
LED	Light Emitting Diode

Nm	Newton-meters (a measurement of torque)
V	Volts
VAC	Volts AC
VDC	Volts DC
W	Watts

## Related Information

You can find more information about Xantrex products and services at [www.xantrex.com](http://www.xantrex.com).

**NOTE:** The Installation Guide (Document Part Number: Freedom Xi Sine Wave Inverter Installation Guide (Doc. Part Number: 975-0753-01-01)) is intended for qualified personnel. Qualified personnel have training, knowledge, and experience in:

- Installing electrical equipment (up to 1000 volts).
- Applying all applicable installation codes.
- Analyzing and reducing the hazards involved in performing electrical work.
- Selecting and using Personal Protective Equipment (PPE).

# Important Safety Instructions

---

**IMPORTANT:** READ AND SAVE THIS OWNER'S GUIDE FOR FUTURE REFERENCE.

---

This guide contains important safety instructions for the Freedom Xi Sine Wave Inverter that must be followed during operation and troubleshooting. **Read and keep this Owner's Guide for future reference.**

Read these instructions carefully and look at the equipment to become familiar with the device before trying to install, operate, service or maintain it. The following special messages may appear throughout this bulletin or on the equipment to warn of potential hazards or to call attention to information that clarifies or simplifies a procedure.



The addition of either symbol to a "Danger" or "Warning" safety label indicates that an electrical hazard exists which will result in personal injury if the instructions are not followed.



This is the safety alert symbol. It is used to alert you to potential personal injury hazards. Obey all safety messages that follow this symbol to avoid possible injury or death.

---

## **DANGER**

**DANGER** indicates an imminently hazardous situation, which, if not avoided, will result in death or serious injury.

## **WARNING**

**WARNING** indicates a potentially hazardous situation, which, if not avoided, can result in death or serious injury.

## **CAUTION**

**CAUTION** indicates a potentially hazardous situation, which, if not avoided, can result in moderate or minor injury.

## **NOTICE**

**NOTICE** indicates a potentially hazardous situation, which, if not avoided, can result in equipment damage.

**Important:** These notes describe things which are important for you to know, however, they are not as serious as a caution or warning.

## Safety Information

1. **Before using the Inverter, read all instructions and cautionary markings on the unit, the batteries, and all appropriate sections of this manual.**
2. Use of accessories not recommended or sold by the manufacturer may result in a risk of fire, electric shock, or injury to persons.
3. The inverter is designed to be connected to your AC and DC electrical systems. The manufacturer recommends that all wiring be done by a certified technician or electrician to ensure adherence to the local and national electrical codes applicable in your jurisdiction.
4. To avoid a risk of fire and electric shock, make sure that existing wiring is in good condition and that wire is not undersized. Do not operate the inverter with damaged or substandard wiring.
5. Do not operate the inverter if it has been damaged in any way.
6. This unit does not have any user-serviceable parts. Do not disassemble the inverter except where noted for connecting wiring and cabling. See your warranty for instructions on obtaining service. Attempting to service the unit yourself may result in a risk of electrical shock or fire. Internal capacitors remain charged after all power is disconnected.
7. To reduce the risk of electrical shock, disconnect both AC and DC power from the inverter before attempting any maintenance or cleaning or working on any components connected to the inverter. Turning off the Inverter using the Inverter Power button on the front panel will not reduce an electrical shock hazard.
8. The inverter must be provided with an equipment-grounding conductor connected to the AC input ground.
9. Do not expose this unit to rain, snow, or liquids of any type. This product is designed for indoor use only. Damp environments will significantly shorten the life of this product and corrosion caused by dampness will not be covered by the product warranty.
10. To reduce the chance of short-circuits, always use insulated tools when installing or working with this equipment.
11. Remove personal metal items such as rings, bracelets, necklaces, and watches when working with electrical equipment.

### **DANGER**

#### **ELECTRICAL SHOCK AND FIRE HAZARD**

Installation must be done by qualified personnel to ensure compliance with all applicable installation and electrical codes and regulations. Instructions for installing the Freedom Xi Sine Wave Inverter are provided here for use by qualified personnel only.

**Failure to follow these instructions will result in death or serious injury.**

 **DANGER**

**HAZARD OF ELECTRIC SHOCK, EXPLOSION, OR ARC FLASH**

- Apply appropriate personal protective equipment (PPE) and follow safe electrical work practices. See NFPA 70E or CSA Z462.
- This equipment must only be installed and serviced by qualified electrical personnel.
- Turn off all power supplying this equipment before working on or inside equipment.
- Always use a properly rated voltage sensing device to confirm power is off.
- Replace all devices, doors, and covers before turning on power to this equipment.

**Failure to follow these instructions will result in death or serious injury.**

 **WARNING**

**FIRE AND EXPLOSION HAZARD**

- Unit's components may produce arcs or sparks.
- Do not install near batteries, in machinery space, or in an area in which ignition-protected equipment is required.

**Failure to follow these instructions can result in death or serious injury.**

Areas include any space containing gasoline-powered machinery, fuel tanks, as well as joints, fittings, or other connections between components of the fuel system.

**⚠ CAUTION**

**ELECTRICAL SHOCK AND FIRE HAZARD**

- Do not open. No serviceable parts inside. Provided with integral protection against overloads. Bonding between conduit connections is not automatic and must be provided as part of the installation.
- Read manual before installing or using.
- Do not cover or obstruct ventilation openings.
- Do not mount in zero-clearance compartment – overheating may result.
- Do not expose to rain or spray. This inverter is designed for marine applications only when additional drip protection is installed in certain orientations. See “Approved Mounting Orientations” on the Installation Guide for more information.
- Use GFCIs only as specified in the manuals supplied with unit. Other types may fail to operate when connected to this unit.
- Do not connect AC OUT to any other source of power. Damage to unit may occur.
- For AC IN and AC OUT, use wires suitable for at least 75°C.

**Failure to follow these instructions can result in minor or moderate injury.**

**NOTES:**

1. Follow these instructions and those published by the battery manufacturer and the manufacturer of any equipment you intend to use in the vicinity of the battery. Review cautionary markings on these products and on the engine.
2. Freedom Xi inverter products are designed for deep cycle lead-acid batteries only. The Freedom Xi does not support lithium-ion batteries.
3. Do not use transformerless battery chargers in conjunction with the inverter due to overheating.

**⚠ CAUTION**

**PHYSICAL INJURY HAZARD**

This Freedom Xi Sine Wave Inverter is not intended for use by persons (including children) with reduced physical, sensory, or mental capabilities or lack of experience and knowledge, unless they have been given supervision or instruction concerning use of the appliance by a person responsible for their safety. Children should be supervised to ensure that they do not play with the appliance.

**Failure to follow these instructions can result in minor or moderate injury.**



## Precautions When Working With Batteries

**Important:** Battery work and maintenance must be done by qualified personnel knowledgeable about batteries to ensure compliance with battery handling and maintenance safety precautions.

### **WARNING**

#### **BURN FROM HIGH SHORT-CIRCUIT CURRENT, FIRE AND EXPLOSION FROM VENTED GASES HAZARDS**

- Always wear proper, non-absorbent gloves, complete eye protection, and clothing protection. Avoid touching your eyes and wiping your forehead while working near batteries. See note #4.
- Remove all personal metal items, like rings, bracelets, and watches when working with batteries. See notes #5 and #6 below.
- Never smoke or allow a spark or flame near the engine or batteries.

**Failure to follow these instructions can result in death or serious injury.**

#### **NOTES:**

1. Mount and place the Freedom Xi Sine Wave Inverter unit away from batteries in a well ventilated compartment.
2. Always have someone within range of your voice or close enough to come to your aid when you work near a lead-acid battery.
3. Always have plenty of fresh water and soap nearby in case battery acid contacts skin, clothing, or eyes.
4. If battery acid contacts skin or clothing, wash immediately with soap and water. If acid enters your eye, immediately flood it with running cold water for at least twenty minutes and get medical attention immediately.

5. Use extra caution to reduce the risk of dropping a metal tool on the battery. It could spark or short circuit the battery or other electrical parts and could cause an explosion.
6. Batteries can produce a short circuit current high enough to weld a ring or metal bracelet or the like to the battery terminal, causing a severe burn.
7. When removing a battery, always remove the negative terminal from the battery first for systems with grounded negative. If it is grounded positive, remove the positive terminal first. Make sure all loads connected to the battery and all accessories are off so you don't cause an arc.

## Precautions When Placing the Inverter

### **WARNING**

#### **FIRE HAZARD**

Do not install the inverter or any part of its supplied wiring in engine compartments.

**Failure to follow these instructions can result in death or serious injury.**

### **CAUTION**

#### **BURN HAZARD**

Avoid touching the external surfaces - heatsink may be hot.

**Failure to follow these instructions can result in minor or moderate injury.**

### **NOTICE**

#### **RISK OF DAMAGE TO THE INVERTER**

- Never allow battery acid to drip on the inverter when reading gravity, or filling battery.
- Never place the Freedom Xi Sine Wave Inverter unit directly above batteries; gases from a battery will corrode and damage the inverter.
- Do not place a battery on top of the inverter.

**Failure to follow these instructions can damage the unit and/or equipment.**

## Regulatory

The Freedom Xi Sine Wave Inverter is certified to appropriate US and Canadian standards. For more information see “Regulatory Approvals” on page 32.

The Freedom Xi Sine Wave Inverter is intended to be used for mobile or commercial applications. This Inverter is designed for marine applications only when additional drip protection is installed in certain orientations. See the section on Specifications for information.

## FCC Information to the User

This equipment has been tested and found to comply with the limits for a Class B digital device, pursuant to part 15 of the FCC Rules. These limits are designed to provide reasonable protection against harmful interference in a residential installation. This equipment generates, uses, and can radiate radio frequency energy and, if not installed and used in accordance with the instructions, may cause harmful interference to radio communications.

However, there is no guarantee that interference will not occur in a particular installation. If this equipment does cause harmful interference to radio or television reception, which can be determined by turning the equipment off and on, the user is encouraged to try to correct the interference by one or more of the following measures:

- Reorient or relocate the receiving antenna.
- Increase the separation between the equipment and receiver.
- Connect the equipment into an outlet on a circuit different from that to which the receiver is connected.
- Consult the dealer or an experienced radio/TV technician for help.

 <b>CAUTION</b>
Unauthorized changes or modifications to the equipment could void the user's authority to operate the equipment.



# Contents

Important Safety Instructions . . . . .	iii
Introduction . . . . .	1
Features . . . . .	4
Freedom Inverter Configuration . . . . .	7
Freedom Inverter Operation . . . . .	11
Operating in Shore Power Mode . . . . .	13
Operating in Inverter Mode . . . . .	14
Operating During Transition Between Shore Power and Inverter Mode . . . . .	17
Invert Power Derating vs. Ambient Temperature . . . . .	21
Troubleshooting . . . . .	23
Warning Messages . . . . .	24
Troubleshooting Reference . . . . .	26
Inverter Applications . . . . .	30
Specifications . . . . .	31

---

---

# Introduction

The Freedom Xi Sine Wave Inverter (Freedom Xi) is designed with integrated inverting functions and power management features suitable for marine, recreational, and commercial vehicle installations.

Please read this chapter to familiarize yourself with the main performance and protection features of the Freedom Xi.

## Materials List

The Freedom Xi base package includes the minimum following items:

- one Freedom Xi unit
- one set of owner's and installation guides
- one display panel with 7-inch (0.17 m) cable
- one 25-foot (7.5 m) communications cable
- two DC terminal covers
- two strain-relief bushings
- one GFCI cover plate
- one pair AC compartment cover plates
- one display panel blanking plate (not shown)
- one display panel mounting bezel (not shown)
- one set of lock washers and nuts (not shown)

**NOTE:** If any of the items are missing, contact Xantrex or any authorized Xantrex dealer for replacement. See "Contact Information" on page i.

Other Freedom Xi OEM models may include other DC and/or AC connectors.

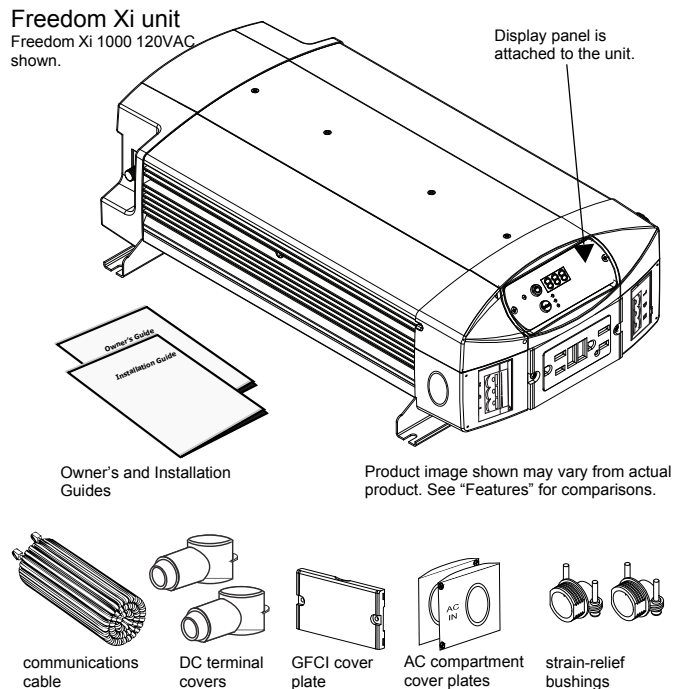

Figure 1 What's In The Box

## Key Features

**Power for Most Appliances** The Freedom Xi inverter provides up to 1000 watts<sup>a</sup> or up to 2000 watts<sup>b</sup> of continuous utility grade, sine wave power derived from a battery bank. It is designed to handle loads such as microwave ovens, TVs, DVD/Blu-ray players, and power tools. In addition, the Freedom Xi's high-surge capability lets you handle many hard-to-start loads, including large TVs and small refrigerators.

The built-in transfer switch automatically transfers between inverter power and shore power from recreational facilities such as boat docks or campsites to ensure power is always available.

**Comprehensive Protection** The Freedom Xi's built-in protection features safeguard your batteries and equipment, such as:

- the low battery voltage alarm and shutdown prevents your batteries from becoming completely discharged
- when shore power is available, inverter power switches automatically to shore power in milliseconds allowing continuous operation of connected equipment

**Back-up Capability** If incoming shore power is interrupted by external events like brownouts, the Freedom Xi automatically becomes an independent power source<sup>c</sup> that supplies utility grade AC power to your loads.

**Overload Alarm and Shutdown** During inverter mode, the Freedom Xi automatically alerts you if the loads that are connected and drawing power from the unit are close to approaching the maximum operating limit. If so, the Freedom Xi automatically shuts down when the maximum operating limit is exceeded.

---

a. Freedom Xi 1000 120VAC (PN: 807-1000)

b. Freedom Xi 2000 120VAC (PN: 807-2000)

---

c. Assuming the inverter is connected to a battery source with an adequate charge at the time of the power interruption.



**Over temperature Alarm and Shutdown** During inverter mode, the Freedom Xi automatically alerts you if it is overheating and approaching the over-temperature shutdown limit.

The Freedom Xi automatically shuts down when the limit is exceeded.

**Low Power Consumption** When the Freedom Xi is inverting without a load, it draws less than 0.6 amp of current from the battery (or battery bank).

This feature allows the unit to operate without draining too much stored energy.

**Selectable Low Battery Shutdown** The low battery shutdown for the inverter can be manually selected by the user by choosing a low (10.5 V), middle (11.8 V), or high (12.1 V) setting.

**Ignition Control** The Freedom HFS provide two user-selectable ignition control method:

- **Ignition Lockout:** The Freedom Xi features the ability to inhibit the inverter from operating in the absence of a voltage signal from a vehicle's ignition circuit. This is particularly useful if the inverter is required to operate only when a vehicle's engine is running.
- **Ignition Auto-on:** The Freedom Xi can automatically turn the inverter on and off with the vehicle's ignition circuit.

**Inverter Power Save** The Freedom Xi has the ability to automatically turn off after 25 hours of continued operation of loads that are under 50 watts. It is designed to, in conjunction with LBCO, to prevent the battery from deep discharge.

# Features

Table 1 lists the default settings for the Freedom Xi system.

You may record your settings in the right-hand column after you have configured the Freedom Xi.

**Table 1** Freedom Xi Default Values

Item	Default Setting	Your Setting
Alarm*	ON (AL I)	
Low Voltage Shutdown*	5dL	
Invert Mode*	l n l	
Inverter Ignition Control	OFF	

\* adjustable from the display panel

## Front Panel (All Models)

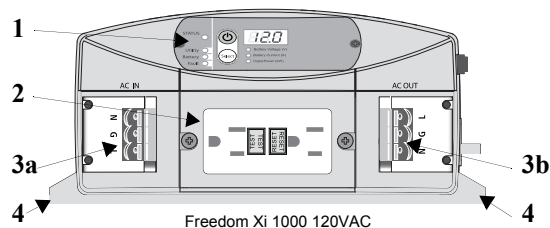

Feature	Description
1	<b>Display panel</b> displays inverter status and battery status information on the screen. The panel can be detached to extend and mount the panel on a wall or other location.
2	<b>GFCI receptacles</b> during inverter mode provide 1000 watts (Freedom Xi 1000 models) or 2000 watts (Freedom Xi 2000 models) of power to operate AC devices.
3	<b>WAGO<sup>a</sup> AC terminals (with terminal inspection covers)</b> for connecting AC input ( <b>3a</b> ) and AC output ( <b>3b</b> ) wiring.
4	<b>Mounting flange</b> allows you to mount the inverter permanently.

a. WAGO manufactures connection devices such as terminal blocks and related accessories. Freedom Xi models indicated above use WAGO terminal blocks as AC input and output connections.

## Rear Panel (All Models)

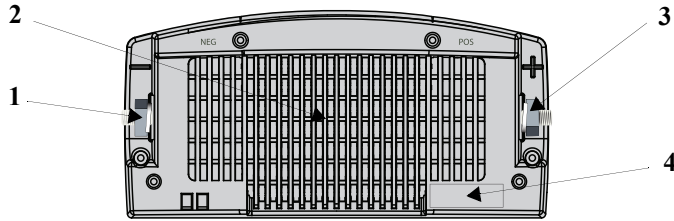

Freedom Xi 1000 shown

## Display Panel (All Models)

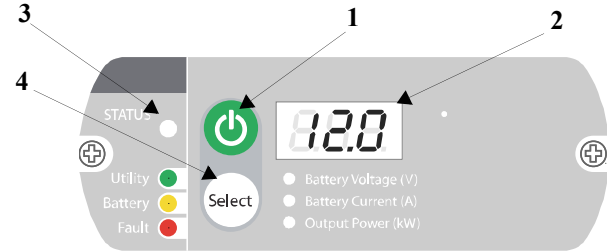

Feature	Description
1	<b>Negative DC cabling terminal</b> connects to the negative terminal of the battery using a battery cable.
2	<b>Ventilation grille (openings)</b> must not be obstructed for the proper operation of the cooling fan and inverter. When the inverter is mounted, the ventilation grille must not point up or down.
3	<b>Positive DC cabling terminal</b> connects to the positive terminal of the battery using a battery cable.
4	<b>Serial number</b> of your unit.

Feature	Description
1	<b>Inverter Power button</b> is the main unit switch that turns the Freedom Xi's inverter mode ON or OFF. See page 11 for additional information.
2	<b>Three-digit LED display screen</b> shows status information and fault codes. See page 11 for additional information.
3	<b>Status LED</b> indicates the mode of operation with a three-color LED. See page 11 for additional information.
4	<b>Select button</b> changes status information displayed on the display screen. See page 11 for additional information.

**IMPORTANT:** See "Display Panel Operation" on page 11 for detailed information on operating the panel's buttons.

## Side Panel

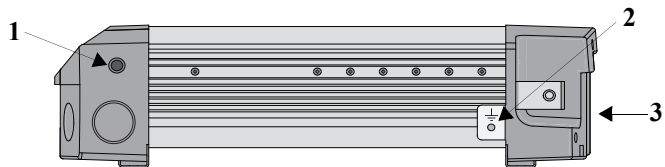

Feature	Description
1	<p><b>20 A supplementary protector (PN: 807-2000)</b> provides overload protection for the GFCI receptacles. In a hard wired installation, the supplementary protector does not protect output wiring.</p> <p><b>15 A supplementary protector (PN: 807-1000)</b> provides overload protection for the GFCI receptacles. In a hard wired installation, the supplementary protector does not protect output wiring.</p>
2	<p><b>Grounding stud</b> provides a ground path for the Freedom Xi chassis to the DC system ground.</p>
3	<p><b>Main cooling fan</b> turns on when powering loads above 500 watts or when the internal temperature reaches a set point temperature.</p>

# Freedom Inverter Configuration

## Viewing Inverter Information

The LED screen displays Inverter information as well as feature settings in coordination with the LED lights underneath the screen.

- ◆ Press the Select button to toggle between the following basic information:

<b>Info and Setting</b>	<b>LED Screen</b>	<b>Info and Settings LED</b>
Battery Voltage	<i>12.8</i> (example)	Solid – Input Voltage (V)
Battery Current	<i>11</i> (example)	Solid – Input Current (A)
Inverter AC Output Power	<i>0.85</i> (example)	Solid – Output Power (kW)

- ◆ Press and hold the Select button to view advanced setting information. The display automatically exits after 5 seconds.

<b>Info and Setting</b>	<b>LED Screen</b>	<b>Info and Settings LED</b>
Inverter Mode Setting	<i>1 n0</i> or <i>1 n 1</i> or <i>1 n2</i>	none
Alarm Setting	<i>AL0</i> or <i>AL 1</i>	none

## Adjusting Feature Settings

The Power and Select buttons can be used to:

- change the inverter mode setting
- disable or enable the audible alarm
- change the shutdown setting
- return to factory default settings

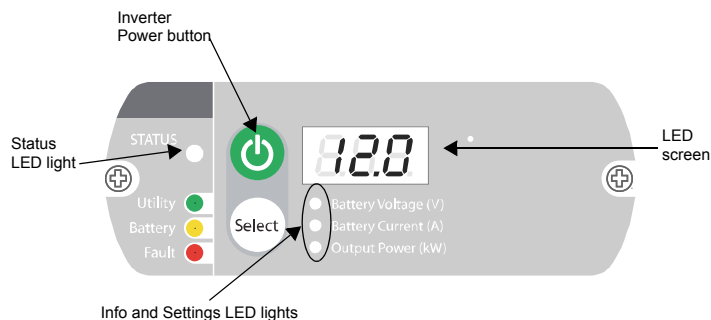

**Figure 2** Display Panel

### To cycle through the various feature settings:

1. Press and hold the Inverter Power button for five seconds to enter the feature settings mode.
2. Press the Inverter Power button to toggle between the following information:

Setting	LED Screen
Inverter Mode Setting	<i>1 n</i>
Alarm Setting	<i>AL</i>
Shutdown Setting	<i>5d</i>
Factory Setting	<i>dEF</i>

### To change the inverter mode setting:

By default the inverter mode is set to ON (“*1 n 1*”).

1. Press and hold the Inverter Power button for five seconds.
2. Press the Inverter Power button until the LED screen flashes “*1 n*” intermittently.
3. Press the Select button once.

The LED screen will display the present (or most recent) inverter mode setting.

<i>1 n 1</i>	Inverter mode setting is ON with Power Save feature
<i>1 n 2</i>	Inverter mode setting is ON without Power Save feature
<i>1 n 0</i>	Inverter mode setting is OFF

4. Continue pressing the Select button to cycle through the three settings – “**I n I**”, “**I n 2**”, and “**I n 0**” until you reach the desired setting.
5. Press and hold the Select button for five seconds to make the setting permanent.

---

**NOTE:** Inverter mode ON (“**I n I**”) will put the inverter on standby with the power save feature. Inverter mode ON (“**I n 2**”) will put the inverter on standby but without the power save feature. Both inverter modes mean that when shore power is present, AC shore power will pass through as AC output. And when shore power is not available, the inverter will take power from the battery and provide AC output power. The inverter is in operation. When the inverter mode is ON, you can manually turn inverter operation ON or OFF by using the Inverter Power button. For information on the Power Save feature, see “Power Save Feature” on page 14.

Inverter mode OFF (“**I n 0**”) completely disables inverter operation. When in this mode, it means that when AC shore power is present, shore power will still pass through as AC output. However, when shore power is not available, inverter operation remains disabled and therefore the unit does not provide AC output power. When the inverter mode is OFF, you cannot manually turn inverter operation ON or OFF by using the Inverter Power button.

---

### To adjust the alarm setting:

By default the alarm is set to ON (“**AL I**”).

1. Press and hold the Inverter Power button for five seconds.
2. Press the Inverter Power button until the LED screen flashes “**AL**” intermittently.
3. Press the Select button once.

The LED screen will display the present (or most recent) alarm setting.

<b>AL I</b>	Sounds the alarm on all detected warning and fault conditions
<b>AL 0</b>	Mutes the alarm

4. Continue pressing the Select button to cycle through the two settings – “**AL 0**” and “**AL I**” until you reach the desired setting.
5. Press and hold the Select button for five seconds to make the setting permanent.

### To adjust the low battery shutdown setting:

By default the low battery shutdown voltage setting is set to Low (“**SdL**”).

1. Press and hold the Inverter Power button for five seconds.
2. Press the Inverter Power button until the LED screen flashes “**Sd**” intermittently.
3. Press the Select button once.

The LED screen will display the present (or most recent) low voltage setting. For example, “**SdL**” is for a low shutdown voltage setting.

<b>SdL</b>	low setting = 10.5 V
<b>Sdī</b>	middle setting = 11.8 V
<b>SdH</b>	high setting = 12.1 V

4. Continue pressing the Select button to cycle through the three – “**SdL**”, “**Sdī**” and “**SdH**” settings until you reach the desired setting.
5. Press and hold the Select button for five seconds to make the setting permanent.

### To return all feature settings to factory default settings:

1. Press and hold the Inverter Power button for five seconds.
2. Press the Inverter Power button until the LED screen flashes “**dEF**” intermittently.
3. Press and hold the Select button for five seconds to return all feature settings to their factory default settings.



# Freedom Inverter Operation

## Display Panel Operation

The Freedom Xi features a display panel with three-digit LED display to show inverter, AC source, and battery status information.

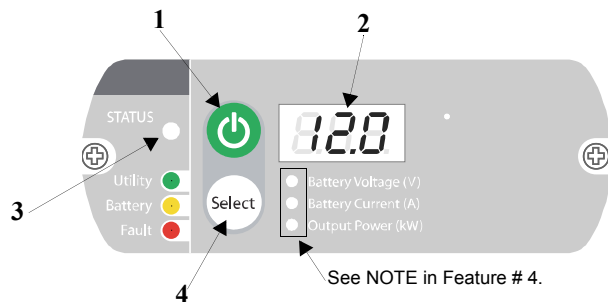

Feature	Description
1	<p><b>Inverter Power button</b></p> <ul style="list-style-type: none"> <li>Press and hold for one second to turn the Freedom Xi's inverter operation ON or OFF (when AC Shore Power is NOT present).</li> <li>Press and hold for five seconds to adjust feature settings. Go back to page 8 for instructions.</li> </ul>

Feature	Description
2	<p><b>Three-digit LED display screen</b> shows status information and detected fault codes. Upon startup, the screen shows the display board (<i>U 1.0</i>) and main board (<i>r 1.0</i>) firmware versions.</p>
3	<p><b>Status LED</b> Indicates the mode of operation with a three-color LED.</p> <ul style="list-style-type: none"> <li><b>Green</b> pertains to <b>Utility</b> status. <ul style="list-style-type: none"> <li>Solid indicates the Freedom Xi is in shore power mode.</li> </ul> </li> <li><b>Yellow</b> pertains to <b>Battery</b> status. <ul style="list-style-type: none"> <li>Solid indicates the Freedom Xi is in inverter operation and using the battery to provide AC power.</li> <li>Flashing indicates the Freedom Xi is in inverter operation but AC shore power is detected thus transferring to shore power mode within 20 seconds.</li> </ul> </li> <li><b>Red</b> indicates that an <b>Error</b> condition has been detected and the Freedom Xi has shut down. See "Troubleshooting Reference" on page 26.</li> </ul>

Feature	Description
4	<p data-bbox="207 146 347 168"><b>Select button</b></p> <ul data-bbox="207 178 773 288" style="list-style-type: none"><li>• During inverter operation, press the button to choose what appears in the three-digit LED display: <b>Battery Voltage</b>, <b>Battery Current</b>, or <b>Output Power</b>. See “To change the inverter mode setting:” on page 8.</li></ul> <p data-bbox="245 323 773 376"><b>NOTE:</b> A corresponding LED lights up for each of the three items.</p> <div data-bbox="272 391 402 455"></div> <ul data-bbox="277 461 412 525" style="list-style-type: none"><li><input checked="" type="radio"/> Battery Voltage (V)</li><li><input type="radio"/> Battery Current (A)</li><li><input type="radio"/> Output Power (kW)</li></ul> <ul data-bbox="207 536 792 618" style="list-style-type: none"><li>• In an Alarm condition, press and hold for two seconds to disable (or enable) the audible alarm. See “To adjust the alarm setting:” on page 9.</li></ul>

# Operating in Shore Power Mode

The Freedom Xi operates in shore power mode when an AC source (a generator or utility power) is present at the AC input terminals. When the AC source is within operating range, the Freedom Xi unit bypasses inverter mode and powers the appliances connected to the unit. See “Transitioning from Inverter Mode to Shore Power” on page 17.





The Green status LED lights up to indicate that the Freedom Xi is using utility (or generator) power and the battery is full.

When shore power is present, AC power automatically passes through the Freedom Xi. Pressing the Inverter Power button on the display panel does not interrupt the supply of shore power. Shore Power mode supersedes Inverter operation.

When the Freedom Xi’s Inverter Power button is turned ON and the AC source is outside the operating range or is disconnected, the transfer switch automatically switches to inverter operation. See “Transitioning from Shore Power to Inverter Mode” on page 17.

# Operating in Inverter Mode

The Freedom Xi is in inverter operation (operating in inverter mode) when all the following conditions exist:

- inverter power button is ON 
- inverter mode setting is ON 
- shore power is not presently available 
- battery has sufficient power 

Inverter operation means that DC battery power is presently being converted to utility grade AC power, powering equipment and appliances connected to the AC output terminal of the unit.

The Yellow status LED lights up to indicate the Freedom Xi is using the battery to power the equipment and appliances.

## Turning Inverter Operation ON and OFF

The Inverter Power button on the display panel turns the Freedom Xi's inverter operation ON or OFF.

- ◆ Press the button and hold for one second.

### **WARNING**

#### **ELECTRICAL SHOCK HAZARD**

Turning the Inverter mode setting to OFF and/or turning the Inverter Power button off does not disconnect DC battery power from the Freedom Xi. You must disconnect both AC and DC power before working on any circuits connected to the unit.

**Failure to follow these instructions can result in death or serious injury.**

To prevent unnecessary battery discharge, turn the Inverter Power button off when you are not using the Freedom Xi.

## Power Save Feature

The Power Save feature is a 25-hour countdown that automatically shuts down inverter operation to reduce battery discharge and preserve battery life. During continuous inverter operation, a 25-hour countdown is initiated when power from the AC load drops to less than approximately 50 watts and remains below this level. After 25 hours the inverter automatically shuts down.

To enable this feature the inverter mode setting must be set to "I n P". See "To change the inverter mode setting:" on page 8.

## Status LED During Inverter Operation

The following summarizes the behavior of the Status LED during Inverter operation.

**Table 2** Status LED during Inverter Operation

Status LED	Display Screen	Condition
Solid YELLOW	<b>12.8</b> (where 12.8 is an example of battery voltage)	Select button is pressed to display Input Battery Voltage. The Input Battery Voltage LED lights up. Value in display screen is shown as Volts.
	<b>11</b> (where 11 is an example of current)	Select button is pressed to display Input Current. The Input Current LED lights up. Value in display screen is shown as Amps.
	<b>0.85</b> (where 0.85 is an example of output power in Kilowatts)	Select button is pressed to display Output Power. The Output Power LED lights up. Value in display screen is shown as Kilowatts.

**Table 2** Status LED during Inverter Operation

Status LED	Display Screen	Condition
Solid RED	<b>E01</b> through <b>E04</b>	Fault condition detected and AC output power is not available. For details, see Table 3, “Error Codes Displayed on the Display Panel Screen” on page 24.
	<b>E05</b> through <b>E07</b>	Warning condition detected while AC output power is still available. See Table 3, “Error Codes Displayed on the Display Panel Screen” on page 24.
Off	Off	Inverter operation is OFF.
Off (or Yellow)	<b>00.0</b>	No communication between the Freedom Xi and the Display Panel because the battery voltage was too low to start the Inverter.

## Checking Battery Status

During inverter operation, you can check the battery status by pressing the Select button until the Battery Voltage LED (or Battery Current LED) illuminates. The battery voltage (or battery current) appears in the three-digit LED display screen when the Battery Voltage LED (or Battery Current LED) illuminates.

The normal operating battery voltage range is between 11 and 15 volts.

## Checking Output Power

During inverter operation, you can check how much power (displayed in kW) the Freedom Xi is supplying to the connected loads by pressing the Select button until the Output Power LED illuminates.

## Operating Several Loads at Once

If you are going to operate several loads from the Freedom Xi, turn them on one at a time after you have turned the inverter on.

Turning loads on separately helps to ensure that the inverter does not have to deliver the starting current for all the loads at once, and will help prevent an overload shutdown.

## Turning the Audible Alarm ON or OFF

The Freedom Xi's audible alarm can be turned ON or OFF. See "To adjust the alarm setting:" on page 9.

Any warnings such as fault conditions or imminent shutdown are both displayed on the display panel's screen and sounded on the alarm speakers.

It is not possible to turn OFF the screen and prevent it from displaying error codes but it is possible to turn OFF the audible alarm.

---

**NOTE:** The alarm setting will reset to its default setting when the Freedom Xi's Inverter Power button is turned OFF then turned ON again.

---

# Operating During Transition Between Shore Power and Inverter Mode

The Freedom Xi's advanced power management is capable of transitioning power from an AC source to DC source within a fraction of a second and vice-versa.

The Freedom Xi automatically detects when shore power is present and when it becomes unavailable or drops to less than 90 volts AC.

## Transitioning from Shore Power to Inverter Mode

When the unit is operating in shore power mode and shore power is lost, the Freedom Xi has less than 40 milliseconds to switch to operating in inverter mode and start drawing power from the battery.

The Status LED will turn from solid (or flashing) GREEN to a solid YELLOW.

## Transitioning from Inverter Mode to Shore Power

When the unit is operating in inverter mode and shore power becomes available, the Freedom Xi begins a 20-second countdown to verify the stability of the shore power. If shore power remains stable for a 20-second countdown, at the end of the countdown, the Freedom Xi will switch to shore power mode within 40 milliseconds and start drawing power from the AC source.

The Status LED will turn from solid YELLOW to flashing YELLOW during the 20-second countdown, then turn to GREEN when battery power is transitioned successfully to shore power.

## Operating Limits

### Power Output

The Freedom Xi can deliver up to 1000 watts or 2000 watts of continuous utility grade sine wave AC power. The wattage rating applies to resistive loads such as incandescent lights.

### Input Voltage

The allowable Freedom Xi input battery voltage ranges are shown in the following table:

Operating Condition	Battery Voltage Range	Comment
Full Operating Range	Low:10.5–16.5 volts Mid:11.8–16.5 volts High:12.1–16.5 volts	Low refers to low limit of the low voltage threshold. Mid refers to middle limit of the low voltage threshold. High refers to high limit of the low voltage threshold.
Optimum Performance	12.1–13.0 volts	
Low Voltage Alarm	Low: <11.0 volts Mid: <12.3 volts High:<12.6 volts	A silent low battery warning shows fault code <i>E05</i> on the display.
Low Voltage Shutdown	Low: <10.5 volts Mid: <11.8 volts High:<12.1 volts	A single one-second low battery alarm beeps and the display shows fault code <i>E01</i> . After five minutes, the unit shuts down completely.
Instant Low Voltage Shutdown	<10.2 volts	After two seconds below the limit, the unit shuts down and the low battery alarm sounds a long beep continuously for 30 seconds.
High Voltage Shutdown	16.7 volts	The over-voltage alarm beeps every second and the display shows fault code <i>E02</i> alternating with the battery voltage. The status LED turns red and the display screen is turned OFF within 30 seconds to protect itself from excessive input voltage. <b>NOTE:</b> Although the Freedom Xi incorporates over-voltage protection, it can still be damaged if input voltage exceeds 16.7 volts.



## Overload Conditions

There are two kinds of overload conditions:

- an overload warning
- an overload shutdown

**Overload Warning** When the Freedom Xi's AC load is approximately 100 W below the overload shutdown limit of ~1000 W (for Freedom Xi 1000 models) or ~2000 W (for Freedom Xi 2000 models), the audible alarm beeps once every two seconds and the display screen shows a fault code *E05*.

**Overload Shutdown** When the Freedom Xi's AC load increases to near ~1100 W (for Freedom Xi 1000 models) and ~2100 W (for Freedom Xi 2000 models), the audible alarm beeps every second and the display screen shows a fault code *E03*. The Status LED turns solid RED and in 30 seconds, both the unit and the display screen will shut down to prevent damage to the inverter and protect the battery from being over-discharged.

## High Surge Loads

Some induction motors used in freezers, pumps, and other motor-operated equipment require high surge currents to start. The Freedom Xi may not be able to start some of these motors even though their rated steady state current draw is within the inverter's limits. The unit will shut down and indicate an overload shutdown.

## Over-temperature Conditions

During inverter operation, when the Freedom Xi's internal temperature starts to approach its preset shutdown limit, the alarm will beep every two seconds and the display will show fault code *E07*. If the over-temperature condition persists, the alarm will beep once per second and the display will show fault code *E04*. The Status LED turns solid RED and the inverter will shut down to prevent damage to the inverter and protect the battery from being over-discharged. However, when the internal temperature drops and falls within normal operating temperature, the Freedom Xi will recover automatically and will continue inverting.

## **Routine Maintenance**

### **Freedom Xi Unit**

Minimal maintenance is required to keep your Freedom Xi operating properly. Periodically you should:

- Clean the exterior of the unit with a damp cloth to prevent the accumulation of dust and dirt.
- Ensure that the DC cables are secure and fasteners are tight.
- Make sure the ventilation openings are not clogged.

# Invert Power Derating vs. Ambient Temperature

If the unit is in inverter mode and in elevated ambient temperature above 25 °C, you will have to reduce power draw according to the following chart to avoid over-temperature shutdown.

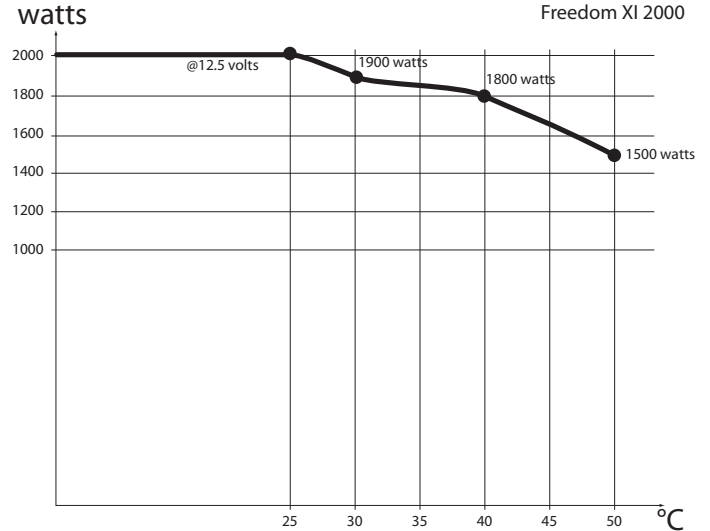
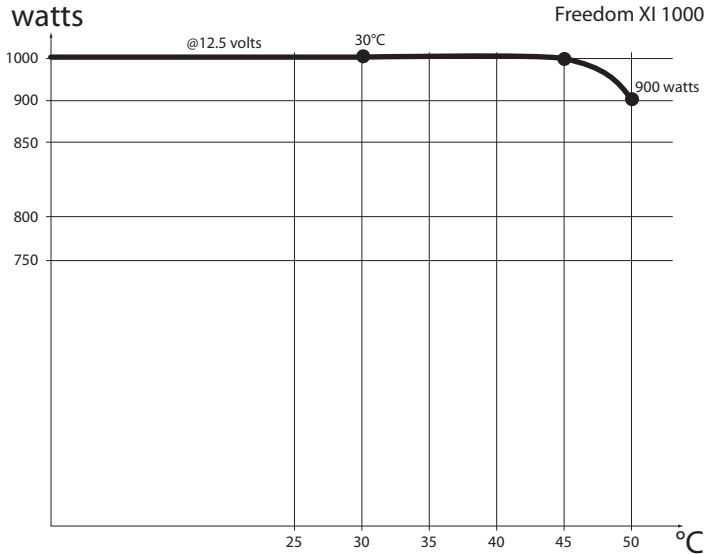



# Troubleshooting

## **WARNING**

### **ELECTRICAL SHOCK HAZARD**

Do not disassemble the Freedom Xi. It does not contain any user-serviceable parts. Attempting to service the unit yourself could result in an electrical shock or burn.

**Failure to follow these instructions can result in death or serious injury.**

**IMPORTANT:** To obtain service go to “Contact Information” on page i.

This section will help you narrow down the source of any problem you encounter. Before contacting customer service, please work through the steps listed below:

1. Check for any error codes displayed on the display screen. If a message is displayed, record it before doing anything further.
2. As soon as possible, record the conditions at the time the problem occurred so you can provide details when you contact customer service for help. Include the following information:
  - What loads the Freedom Xi was running or attempting to run
  - What the battery condition was at the time (voltage, etc.) if known
  - Recent sequence of events
3. If your Freedom Xi is not displaying an error code, check the following to make sure the present state of the installation allows proper operation:
  - Is the inverter located in a clean, dry, adequately ventilated place?
  - Are the battery cables adequately sized as recommended in the Installation guide?
  - Is the battery in good condition?
  - Are all DC connections tight?
  - Are the AC input and output connections and wiring in good condition?
  - Are the configuration settings correct for your particular installation?
  - Are the display panel and the communications cable properly connected and undamaged?
  - Are all disconnects and AC breakers closed and operable?
  - Have any of the fuses blown in the installation?
4. Contact customer support for further assistance. Please be prepared to describe details of your system installation and to provide the model and serial number of the unit.

# Warning Messages

Warning messages in the form of audible alarms and error codes that appear on the display panel screen to alert you to an impending system change. Warnings do not affect operation.

With the exception of the error codes displayed on the screen, only the audible alarm can be turned ON or OFF. Follow the steps in “To adjust the alarm setting:” on page 9 to change the alarm settings.

The error codes are listed in Table 3 below. The text in the **Error Code** column appears on the display screen of the display panel.

**Table 3** Error Codes Displayed on the Display Panel Screen

Error Code	Condition	Mode	Action
E01	Low battery voltage shutdown is imminent depending on the setting, see “Operating Limits” on page 18.	Inverting	<ul style="list-style-type: none"><li>• Check battery status and recharge if necessary.</li><li>• Check for proper DC cable sizing.</li><li>• Check for loose connections and tighten if necessary.</li></ul>
E02	High battery voltage shutdown > 16.7 volts DC	Inverting	<ul style="list-style-type: none"><li>• Check for external charging sources, such as an over voltage alternator, and disconnect if necessary.</li></ul>
E03	AC output overload shutdown	Inverting	<ul style="list-style-type: none"><li>• Reduce the loads connected to the AC outlet of the unit.</li><li>• Check appliances that have high-surge ratings and disconnect if necessary.</li></ul>
E04	Over-temperature shutdown	Inverting	<ul style="list-style-type: none"><li>• Reduce the loads connected to the AC outlet of the unit.</li><li>• Check that the ventilation grille is not blocked.</li><li>• Check for ambient temperature and move the unit to a cooler location whenever possible.</li></ul>

**Table 3** Error Codes Displayed on the Display Panel Screen

<b>Error Code</b>	<b>Condition</b>	<b>Mode</b>	<b>Action</b>
<i>E05</i>	Low battery voltage detected depending on setting, see “Operating Limits” on page 18.	Inverting	<ul style="list-style-type: none"> <li>• Check battery status and recharge if necessary.</li> <li>• Check for proper DC cable sizing.</li> <li>• Check for loose connections and tighten if necessary.</li> </ul>
<i>E06</i>	AC output overload warning	Inverting	<ul style="list-style-type: none"> <li>• Reduce the loads connected to the AC outlet of the unit.</li> </ul>
<i>E07</i>	Over-temperature warning	Inverting	<ul style="list-style-type: none"> <li>• Reduce the loads connected to the AC outlet of the unit.</li> <li>• Check that the ventilation grille is not blocked.</li> <li>• Check for ambient temperature and move the unit to a cooler location whenever possible.</li> </ul>
<i>E08</i>	not used		
<i>E09</i>	not used		

**For error code *E01*:**

- the display screen and the alarm will turn off after 30 seconds
- after a five-minute shutdown delay, the unit will immediately stop inverting

**For error codes *E02* to *E04*:**

- the unit will stop inverting

# Troubleshooting Reference

## **WARNING**

### **ELECTRICAL SHOCK HAZARD**

Do not disassemble the Freedom Xi. It does not contain any user-serviceable parts. Attempting to service the unit yourself could result in an electrical shock or burn.

**Failure to follow these instructions can result in death or serious injury.**

**Table 4** Troubleshooting Reference

<b>Problem</b>	<b>Possible Cause</b>	<b>Solution</b>
Alarm does not sound when an error is encountered.	Alarm is turned OFF.	Press and hold the Select button for two seconds to disable (or enable) the audible alarm. See “Display Panel Operation” on page 11.



**Table 4** Troubleshooting Reference

Problem	Possible Cause	Solution
<p>No output voltage. The status LED is red.</p>	<p>AC shore power is not available or out of operating range and the inverter has shut down with the display screen showing one of the following error codes:</p>	
	<ul style="list-style-type: none"> <li>• Low input voltage (fault code E01)</li> </ul>	<ul style="list-style-type: none"> <li>• Check the DC connections and the cable.</li> <li>• Recharge the battery.</li> </ul>
	<ul style="list-style-type: none"> <li>• High input voltage (fault code E02)</li> </ul>	<ul style="list-style-type: none"> <li>• Verify the unit is connected to a 12V battery.</li> <li>• Check the voltage regulation of the external charging system (if any).</li> </ul>
	<ul style="list-style-type: none"> <li>• Unit overload or AC output short circuit (fault code E03)</li> </ul>	<ul style="list-style-type: none"> <li>• Reduce the load. Make sure the load does not exceed the output rating.</li> </ul>
	<ul style="list-style-type: none"> <li>• Thermal shutdown (fault code E04)</li> </ul>	<ul style="list-style-type: none"> <li>• Allow the unit to cool off.</li> <li>• Reduce the load if continuous operation is required.</li> <li>• Improve ventilation. Make sure the inverter's ventilation openings are not blocked.</li> </ul>
	<ul style="list-style-type: none"> <li>• AC transfer relay has overheated (during shore power mode).</li> </ul>	<ul style="list-style-type: none"> <li>• Improve ventilation. Make sure the inverter's ventilation grille is not blocked.</li> <li>• Reduce the load.</li> </ul>

**Table 4** Troubleshooting Reference

Problem	Possible Cause	Solution
<p>No output voltage. The Status LED is green or yellow.</p>	<p>GFCI has tripped or supplementary breaker has tripped.</p> <p>Circuit breaker on the AC load panel or AC output disconnect has tripped.</p> <p>Battery voltage is too low (depending on setting, see “Operating Limits” on page 18) to start inverting. Display screen may show DC voltage as 00.0.</p>	<p>Check load and reset the GFCI or supplementary breaker.</p> <p>Reset the circuit breaker or check the AC output disconnect circuits.</p> <p>Check DC connections and cable. Recharge battery.</p>
<p>No output voltage. The status LED is not lighting up.</p>	<p>AC shore power is not available or out of operating range and the inverter is OFF.</p> <p>AC shore power is not available and the inverter is OFF due to a shutdown for more than 30 seconds.</p> <p>The inverter’s DC input polarity is reversed.</p>	<ul style="list-style-type: none"> <li>• Check AC shore power.</li> <li>• Turn the inverter ON.</li> </ul> <ul style="list-style-type: none"> <li>• Check AC shore power and battery voltage.</li> <li>• Turn the inverter ON and look at the display panel for any error code.</li> <li>• See Table 3, “Error Codes Displayed on the Display Panel Screen” on page 24.</li> </ul> <p>The inverter was probably damaged due to the reverse polarity. This type of damage is NOT covered by the warranty.</p> <ul style="list-style-type: none"> <li>• Return the unit.</li> <li>• See Warranty Card for information on returning the unit.</li> </ul>

**Table 4** Troubleshooting Reference

<b>Problem</b>	<b>Possible Cause</b>	<b>Solution</b>
No output voltage. The status LED is not lighting up.	The jumper wire on the power module panel connecting the “Ignition Control” and “Disabled” terminals is removed and there is no ignition signal present.	Ensure the jumper wire is installed if the ignition control feature is not in use. If the ignition control feature is in use, ensure the vehicle’s ignition is on.
The fan turns on and off during AC shore power mode.	<ul style="list-style-type: none"> <li>• The battery is discharged.</li> <li>• AC pass-through current is high.</li> </ul>	Do not be alarmed, the unit is performing normally.
The fan turns on and off during inverter mode.	The inverter is running continuously at high power.	Do not be alarmed, the unit is performing normally. The fan is activated automatically.

# Inverter Applications

The Freedom Xi performs differently depending on the AC loads connected to it. If you are having problems with any of your loads, read this section.

## Resistive Loads

These are the loads that the inverter finds the simplest and most efficient to drive. Voltage and current are in phase (that is, in step with one another). Resistive loads usually generate heat in order to accomplish their tasks. Toasters, coffee pots, and incandescent lights are typical resistive loads. It is usually impractical to run larger resistive loads—such as electric stoves and water heaters—from an inverter due to their high current requirements. Even though the inverter can most likely accommodate the load, the size of battery bank required would be impractical if the load is to be run for long periods.

## Motor Loads

Induction motors (that is, motors without brushes) require two to six times their running current on start up. The most demanding are those that start under load, for example, compressors and pumps. Of the capacitor start motors (typical in drill presses, band saws, etc.), the largest you can expect to run is 1/2 to 1 hp (the transfer relays are rated at 2 hp). Universal motors are generally easier to start. Since motor characteristics vary, only testing will determine whether a specific load can be started and how long it can be run. If a motor fails to start within a few seconds or loses power after running for a time, it should be turned off. When the inverter attempts to start a load that is greater than it can handle, it will turn itself off after a few seconds.

**Long Transfer Times** The Freedom Xi may take a long time (~0.1–0.2 seconds) to transfer to inverter mode when shore power is cut off while powering a motor load. Motor loads typically “freewheel” when power is removed (for example, a grinder) and causes a longer transfer time. The longer transition from shore power to inverter power may cause connected computers or other sensitive equipment to operate incorrectly. To avoid this effect, do not connect motor loads together with sensitive equipment to the inverter for power.

# Specifications

**NOTE:** Specifications are subject to change without prior notice.

<b>Physical Specifications</b>	<b>Freedom Xi 1000</b>	<b>Freedom Xi 2000</b>
L × W × H	19.2" (487mm) × 9.4" (240mm) × 4.7" (120mm)	19.2" (487mm) × 9.4" (240mm) × 4.7" (120mm)
Net Weight	11 lbs (5 kg)	14.4 lbs (6.5 kg)

<b>Environmental Specifications</b>	<b>Freedom Xi 1000</b>	<b>Freedom Xi 2000</b>
Ambient Temperature: Operating Temperature Range Storage Temperature Range	-4 –122 °F (-20 –50 °C), with output derated above 77 °F (25 °C) -40–158 °F (-40–70 °C)	
Humidity: Operation/Storage	5–95% RH, non-condensing	

<b>System Specifications</b>	<b>Freedom Xi 1000</b>	<b>Freedom Xi 2000</b>
Transfer relay rating	30A, 2.0hp (24A required derating by electrical code in North America)	
Transfer time (shore to inverter)	<40 milliseconds	
Transfer time (inverter to shore)	<40 milliseconds with a 20-second delay	
Transfer voltage (shore to inverter)	<95 V and >135 V	
Transfer voltage (inverter to shore)	<130 V and >100 V	
Cooling	Fan, activated by any of the following: •High internal temperature •High AC output power	

## Specifications

<b>DC Input</b>	<b>Freedom Xi 1000</b>	<b>Freedom Xi 2000</b>
Operating voltage range for all models	10.5–16.5 VDC (low limit) 11.8–16.5 VDC (mid limit) 12.1–16.5 VDC (high limit)	10.5–16.5 VDC (low limit) 11.8–16.5 VDC (mid limit) 12.1–16.5 VDC (high limit)
Safe non-operating voltage range	0–24 VDC	0–24 VDC
Nominal voltage for all models	12.5 VDC	12.5 VDC
Nominal current at full load	92 ADC	200 ADC

<b>AC Output</b>	<b>Freedom Xi 1000</b>	<b>Freedom Xi 2000</b>
Output voltage range	110–125 VAC	110–125 VAC
Continuous power	1.0kW @ 40 °C	2.0kW @ 25 °C
Continuous current	8.3 A	16.6 A
Surge power	2000 W	4000 W
Max short-circuit current	55 A peak	55 A peak
Frequency	60 Hz	60 Hz
GFCI protection for 120VAC models only	Yes	Yes
Wave shape	True Sine Wave	True Sine Wave
Peak efficiency	≥87%	≥87%
Full load efficiency	≥82%	≥82%

<b>Regulatory Approvals</b>	<b>Freedom Xi 1000</b>	<b>Freedom Xi 2000</b>
EMC and Safety	ETL listed to CSA 107.1 UL458 and UL458 Marine Supplement (drip shield with product number 808-1050 required) ABYC E11, A20, A25, A31	



**Schneider Electric Solar  
Inverters USA Inc.**

+1 800 670 0707  
+1 408 987 6030  
[www.xantrex.com](http://www.xantrex.com)

975-0754-01-01

Printed in China