

USER MANUAL

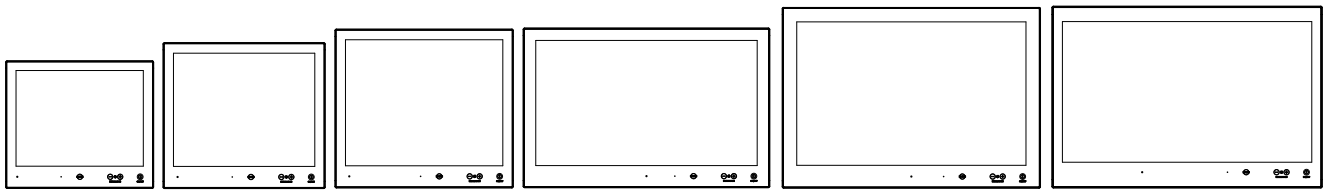

Series X G2 - Maritime Multi Display (MMD) Models

- HD 15T22 MMD-xxx-Fxxx - 15.0 inch Maritime Multi Display
- HD 17T22 MMD-xxx-Fxxx - 17.0 inch Maritime Multi Display
- HD 19T22 MMD-xxx-Fxxx - 19.0 inch Maritime Multi Display
- HD 24T22 MMD-xxx-Fxxx - 24.0 inch Maritime Multi Display
- HD 26T22 MMD-xxx-Fxxx - 25.54 inch Maritime Multi Display
- HD 27T22 MMD-xxx-Fxxx - 27.0 inch Maritime Multi Display

User Manual MMD Series X G2	
Updated: 26 Mar 2018	Doc Id: INB101192-1 (Rev 06)
Created: 363	
Approved: 362	

Please visit www.hatteland-display.com for the latest electronic version of this manual.

Copyright © 2018 Hatteland Display AS
Eikeskogvegen 52, N-5570 Aksdal, Norway.

All rights are reserved by Hatteland Display AS. This information may not, in whole or in part, be copied, photocopied, reproduced, translated or reduced to any electronic medium or machine-readable form without the prior written consent of Hatteland Display AS. Review also:
www.hatteland-display.com/pdf/misc/doc100703-1_permission_to_create_user_manuals.pdf

The products described, or referenced, herein are copyrighted to the respective owners. The products may not be copied or duplicated in any way. This documentation contains proprietary information that is not to be disclosed to persons outside the user's company without prior written consent of Hatteland Display AS.

The copyright notice appearing above is included to provide statutory protection in the event of unauthorized or unintentional public disclosure.

All other product names or trademarks are properties of their respective owners !

WARNING: This is a class A product. In a domestic environment this product may cause radio interference in which case the user may be required to take adequate measures.

Statement above last revised 6 Jan 2015

Contents

Contents	3
Contents of package	8
General	11
About this manual	12
About Hatteland Display.....	12
www.hatteland-display.com.....	12
Contact Information.....	12
Maritime Multi Display (MMD) Generation 2 (G2) - Introduction	13
Product Labeling	14
Touch screen products	18
Installation	21
General Installation Recommendations	22
First Things First!	22
Installation and mounting	22
Installation limitations	23
Ergonomics	25
Cables.....	26
<i>Cable Entries & Connectors (Marked area)</i>	26
<i>Maximum Cable Length</i>	26
Housing / Terminal Block Connector Overview	27
Panel / Console Mounting Bracket Kit for 15, 17 and 19 inch.....	29
Panel Cutout / Console Mounting Bracket Kit for 24 and 27 inch	31
Panel Cutout / Console Mounting Bracket Kit for 26 inch	32
Mounting Bracket, Table / Desktop / Ceiling - 15, 17 and 19 inch.....	33
Mounting Bracket for Table / Desktop installation - 24, 26 and 27 inch	35
Physical Connections.....	37

Contents

Operation	41
User Controls	42
On Screen Display (OSD) Menu Introduction	44
OSD Keycode / OSD Lock Mode	44
OSD “Basic”, “Advanced” & “Service” Menu modes	45
OSD Visual Feedback (examples)	45
OSD Menu Structure	46
<i>Input Source Settings</i>	46
<i>Image Settings</i>	46
<i>Color Mode Settings</i>	47
<i>Multi-PIP Settings</i>	47
<i>OSD Settings</i>	48
<i>Management Settings</i>	49
<i>Service Settings</i>	50
On Screen Display (OSD) Menu Functions	51
Operation Advanced (DDC/CI)	75
Introduction	76
Specifications	79
Specifications - HD 15T22 MMD-xxx-Fxxx	80
Specifications - HD 15T22 MMD-xxx-FHxx.....	81
<i>High Bright model</i>	81
Specifications - HD 17T22 MMD-xxx-Fxxx	82
Specifications - HD 17T22 MMD-xxx-FHxx.....	83
<i>High Bright model</i>	83
Specifications - HD 19T22 MMD-xxx-Fxxx	84
Specifications - HD 19T22 MMD-xxx-FHxx.....	85
<i>High Bright model</i>	85
Specifications - HD 24T22 MMD-xxx-Fxxx	86
Specifications - HD 24T22 MMD-xxx-FHxx.....	87
<i>High Bright model</i>	87
Specifications - HD 26T22 MMD-xxx-Fxxx	88
Specifications - HD 27T22 MMD-xxx-Fxxx	89

Contents

Technical Drawings	91
Technical Drawings - HD 15T22 MMD-xxx-Fxxx.....	92
Technical Drawings - HD 15T22 MMD-xxx-FHxx.....	93
<i>High Bright model</i>	93
Technical Drawings - HD 17T22 MMD-xxx-Fxxx.....	94
Technical Drawings - HD 17T22 MMD-xxx-FHxx.....	95
<i>High Bright model</i>	95
Technical Drawings - HD 19T22 MMD-xxx-Fxxx.....	96
Technical Drawings - HD 19T22 MMD-xxx-FHxx.....	97
<i>High Bright model</i>	97
Technical Drawings - HD 24T22 MMD-xxx-Fxxx.....	98
Technical Drawings - HD 24T22 MMD-xxx-FHxx.....	99
<i>High Bright model</i>	99
Technical Drawings - HD 26T22 MMD-xxx-Fxxx.....	100
Technical Drawings - HD 27T22 MMD-xxx-Fxxx.....	101
Technical Drawings - Accessories.....	103
Technical Drawings - HD TMB SX2-A1.....	104
<i>Desktop/Table Mounting Bracket 15 inch</i>	104
Technical Drawings - HD TMB SX2-A1.....	105
<i>Desktop/Table Mounting Bracket 17 inch</i>	105
Technical Drawings - HD TMB SX2-A1.....	106
<i>Desktop/Table Mounting Bracket 19 inch</i>	106
Technical Drawings - HD TMB SX1-C1.....	107
<i>Desktop/Table Mounting Bracket 24/26/27 inch</i>	107
Technical Drawings - HD CMB SX2-A1.....	108
<i>Console Mount Bracket</i>	108
Technical Drawings - HD CMB SX2-A1.....	109
<i>Console Mount Kit 15 inch</i>	109
Technical Drawings - HD CMB SX2-A1.....	110
<i>Console Mount Kit 17 inch</i>	110
Technical Drawings - HD CMB SX2-A1.....	111
<i>Console Mount Kit 19 inch</i>	111
Technical Drawings - HD CMB SX2-E1.....	112
<i>Console Mount Kit 24 inch</i>	112
<i>Console Mounting 24 inch</i>	113
<i>P006801-1 Flush Mounting 24 inch</i>	114
Technical Drawings - HD CMB SX2-F1.....	115
<i>Console Mount Kit 26 inch</i>	115
<i>Console Mounting 26 inch</i>	116
<i>P007084-1 Flush Mounting 26 inch</i>	117

Contents

Technical Drawings - HD CMB SX2-E1	118
<i>Console Mount Kit 27 inch</i>	118
<i>Console Mounting 27 inch</i>	119
<i>P020721 - Flush Mounting 27 inch</i>	120
Technical Drawings - HD VED SX2-A1	121
<i>VESA Adapter 15 inch</i>	121
Technical Drawings - HD VED SX2-B1	122
<i>VESA Adapter 17 inch</i>	122
Technical Drawings - HD VED SX2-C1	123
<i>VESA Adapter 19 inch</i>	123
Technical Drawings - HD VED SX2-H1	124
<i>VESA Adapter 24, 26, 27 inch</i>	124
Technical Drawings - JH 15TAP STD-C1	125
<i>15 inch Series X to fit 15 inch Series 1 Cutout</i>	125
Technical Drawings - JH 19TAP STD-C1	126
<i>19 inch Series X to fit 19 inch Series 1 Cutout</i>	126
Technical Drawings - HD 19TAP SX2-C2	127
<i>19 inch Series X to fit 19 inch Series 2 Console Cutout</i>	127
Technical Drawings - JH 26TAP STD-A1	129
<i>26 inch Series X to fit 26 inch Series 1 Cutout</i>	129
Technical Drawings - HD 15COV SX1-A1.....	130
<i>UV Sun Cover (15 inch)</i>	130
Technical Drawings - HD 17COV SX1-A1.....	131
<i>UV Sun Cover (17 inch)</i>	131
Technical Drawings - HD 19COV SX1-A1	132
<i>UV Sun Cover (19 inch)</i>	132
Technical Drawings - HD 24COV SX1-A1.....	133
<i>UV Sun Cover (24 inch)</i>	133
Technical Drawings - HD 26COV SX1-A1.....	134
<i>UV Sun Cover (26 inch)</i>	134
Technical Drawings - HD 27COV SX1-A1	135
<i>UV Sun Cover (27 inch)</i>	135
Technical Drawings - P006997-1	136
<i>IP66 Panel Gasket (15 inch)</i>	136
Technical Drawings - P007130-1	137
<i>IP66 Panel Gasket (17 inch)</i>	137
Technical Drawings - P007131-1	138
<i>IP66 Panel Gasket (19 inch)</i>	138
Technical Drawings - P007032-1	139
<i>IP66 Panel Gasket (24 inch)</i>	139
Technical Drawings - P007178.....	140
<i>IP66 Panel Gasket (26 inch)</i>	140

Contents















Technical Drawings - P018743.....	141
<i>IP66 Panel Gasket (27 inch)</i>	141

Appendixes 143

Pinout Assignments.....	144
Basic Trouble-shooting.....	147
Declaration of Conformity.....	148
Return Of Goods Information	149
General Terms and Conditions.....	150
Pixel Defect Policy	151
Notes.....	152
Revision History	154

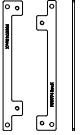
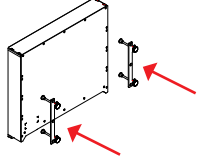
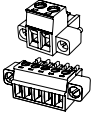

Contents of package

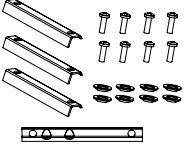
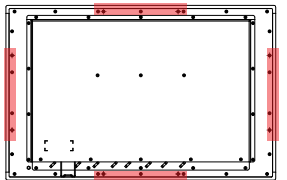
Note: Entries listed below are for Standard factory shipments. Customized factory shipments may deviate from this list.

Item	Description	Illustration
 <p>HA-SDM-2M</p>	<p>1 pcs of Standard DVI Signal Cable. DVI-D 18+1P Male to DVI-D 18+1P Male Single Link - Length 2.0m</p>	
 <p>HA-VGA-2M-32</p>	<p>1 pcs of Standard VGA Signal Cable. DSUB 15P Male to DSUB 15P Male - Length 2.0m</p>	
 <p>TP52/TC01-1,8M</p>	<p>1 pcs of power cable European Type F "Schuko" to IEC. Length 1.8m <i>Note: Included in package for models with AC input.</i></p>	<p>EUR TYPE F</p> 
 <p>TP11/TC01-1,8M</p>	<p>1 pcs of power cable US Type B plug to IEC. Length 1.8m <i>Note: Included in package for models with AC input.</i></p>	<p>US TYPE B</p> 
 <p>DVI-4</p>	<p>1 pcs of DVI > RGB/VGA adapter DVI 12+5P Male to DSUB 15P Female</p>	
 <p>MEDIA STD01</p>	<p>Documentation and Driver DVD/CD containing the user manual, including the Touch Screen driver for units delivered with a factory mounted touch screen. For most recent drivers, please visit "www.hatteland-display.com/archive"</p> <p><i>In some cases (due to revisions) a provisional CD (PRO02-xxx) may be delivered with the unit instead.</i></p>	 <p>Menu browser for Microsoft® Windows® Operating Systems</p>
	<p>Test Report</p>	
 <p>HD CMB SX2-A1</p>	<p>Model Dependent: 2 pcs of Mounting Brackets for Console/Panel Mounting, Anodized Aluminium/Stainless Steel. The bracket kit is suitable for 15, 17 and 19 inch units and is EN60945 Tested (pending). Suitable for panel thickness min: 2.0 [0.08"] to max: 50.00 [1.97"] mm [inch].</p>	
 <p>Terminal Block Connector Kit</p>	<p>Terminal Block Connector Kit as follows (may in some cases be already factory mounted): 1 x 2-pin Terminal Block 5.08 for DC Power In 2 x 5-pin Terminal Block 3.81 for RS-422 / RS-485 / SCOM / Buzzer Module</p> <p>Refer to "Configuring Housing / Terminal Block Connector" section for usage.</p>	 <p>Note: Location of module(s) may differ between unit sizes</p>
 <p>HD CMB SX2-E1 or HD CMB SX2-F1</p>	<p>Model Dependent: Bracket Kit suitable for console/panel mounting which contains: 3 x Mounting Bracket for top, left and right side 1 x Mounting Bracket for bottom side (terminal/connector plate area) 8 x M5x16 screws 8 x C-Washers</p> <p>HD CMB SX2-E1 = Suitable only for 24 and 27 inch units and is EN60945 Tested. HD CMB SX2-F1 = Suitable only for 26 inch units and is EN60945 Tested.</p>	

Contents of package

Package may also include:

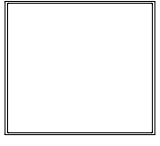
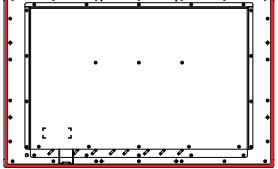
Item	Description	Illustration
 <p>VSD100913-1</p>	<p>1 pcs of Touch Screen Cable USB Type A to Type A. Length Approx 2m.</p> <p><i>Only included in package if model is equipped with factory mounted Touch Screen</i></p>	
	<p>For models (15-27 inch) an EPDM sealing gasket for IP66 console mount may be factory pre-mounted / included with delivery if ordered. For High Bright models, it is pre-mounted by factory default.</p> <p>Details / Type number reference: Surface: RAL9011, Glue: 3M9471LE, Thickness 2mm. P006997-1 (15), P007130-1 (17), P007131-1 (19) P007032-1 (24), P007178 (26), P018743 (27)</p>	

This page left intentionally blank



General

About this manual

The manual contains electrical, mechanical and input/output signal specifications. All specifications in this manual, due to manufacturing, new revisions and approvals, are subject to change without notice. However, the last update and revision of this manual are shown both on the frontpage and also in the "Revision History" chapter at the end of the manual. This User Manual is a standard/general manual that applies to all variations of its product family, i.e. deviation from actual configuration may exist.

Furthermore, for third party datasheet and user manuals, please see dedicated Documentation and Driver DVD delivered with the product or contact our sales/technical/helpdesk personnel for support.

About Hatteland Display

Hatteland Display is the leading technology provider of specialized display and computer products, delivering high quality, unique and customized solutions to the international maritime, naval and industrial markets.

The company represents innovation and quality to the system integrators world wide. Effective quality assurance and investment in sophisticated in-house manufacturing methods and facilities enable us to deliver Type Approved and Mil tested products. Our customer oriented approach, technical knowledge and dedication to R&D, makes us a trusted and preferred supplier of approved solutions, which are backed up by a strong service network.

www.hatteland-display.com

You will find our website full of useful information to help you make an informed choice as to the right product for your needs. You will find detailed product descriptions and specifications for the entire range on Displays, Computers and Panel Computers, Military solutions as well as the range of supporting accessories. The site carries a wealth of information regarding our product testing and approvals in addition to company contact information for our various offices around the world, the global service centers and the technical help desk, all ensuring the best possible support wherever you, or your vessel, may be in the world.

Contact Information

<p>Head office, Vats / Norway: Hatteland Display AS Eikeskogvegen 52 N-5570 Akdsdal, Norway</p> <p>Tel: +47 4814 2200</p> <p>mail@hatteland-display.com</p>	<p>Sales office, Frankfurt / Germany: Hatteland Display GmbH Werner Heisenberg Strasse 12, D-63263 Neu-Isenburg, Germany</p> <p>Tel: +49 6102 370 954 Fax: +49 6102 370 968</p>
<p>Sales office, Oslo / Norway: Strandveien 35 N-1366 Lysaker Norway</p> <p>Tel: +47 4814 2200</p>	<p>Sales office, Aix-en-Provence / France: Hatteland Display SAS Actimart- 1140, rue Ampère, CS 80544 13594 Aix-en-Provence, Cedex 3 France</p> <p>Tel: +33 (0) 4 42 16 47 57 Fax: +33 (0) 4 42 16 47 00</p>
<p>Sales office, Vista / USA: Hatteland Display Inc 380 South Melrose Drive, Suite 349 Vista, CA 92081 USA</p> <p>Tel: +1 760-643-4061 Fax: +1 858-408-1834</p>	

For an up-2-date list, please visit www.hatteland-display.com/locations

Displays Series X Generation 2 (G2)

Maritime Multi Display (MMD) Generation 2 (G2) - Introduction

As a leading manufacturer of display and computer hardware for the maritime segment, Hatteland Display continuously gauges and responds to market needs. Our commitment to develop specialized products for a multitude of onboard ship systems continues with Series X. Their compact and sleek design allows them to be desk mount or console integrated. The design is modular, allowing for common modules to be used in various models and combinations. Together these design features bring about a range perfectly in synch to market cost expectations – along with that, the performance and type approval always expected in all Hatteland Display products.

All sizes are available in display or panel computer formats, as well as various performance specifications to choose from. There are standard base models available which are listed in the following pages. The modules used in Series X, are all qualified having undergone and passed our extensive test program, which includes HALT testing. This means that the products are tested well outside the requirements in EN60945 and E10.

The result is a more reliable product.

In 2017, advancements for the Series X generation two MMD (Maritime Multi Displays) have been rolled out across the 15, 17, 19, 24, 26 and 27 inch models. For users, there is an improved Glass Display Control™ (GDC), GDC backlight uniformity and higher brightness for high luminance environments. For engineers and installers, amongst the developments include improved serviceability, allowing for better access to key components. There is also a new table/ceiling mounting solution for the 15, 17 and 19 inch models.

- MULTITOUCH
- TYPE APPROVED
- ECDIS COMPLIANT
- IP22 REAR / IP66 FRONT
- SUPERIOR BONDING TECHNOLOGY
- MODULE BASED, TAILOR-MADE SYSTEMS MADE EASY!
- SUNLIGHT READABLE / HIGH BRIGHT VERSIONS AVAILABLE
- GLASS DISPLAY CONTROL™ (GDC), SOLID STATE MENU SYSTEM

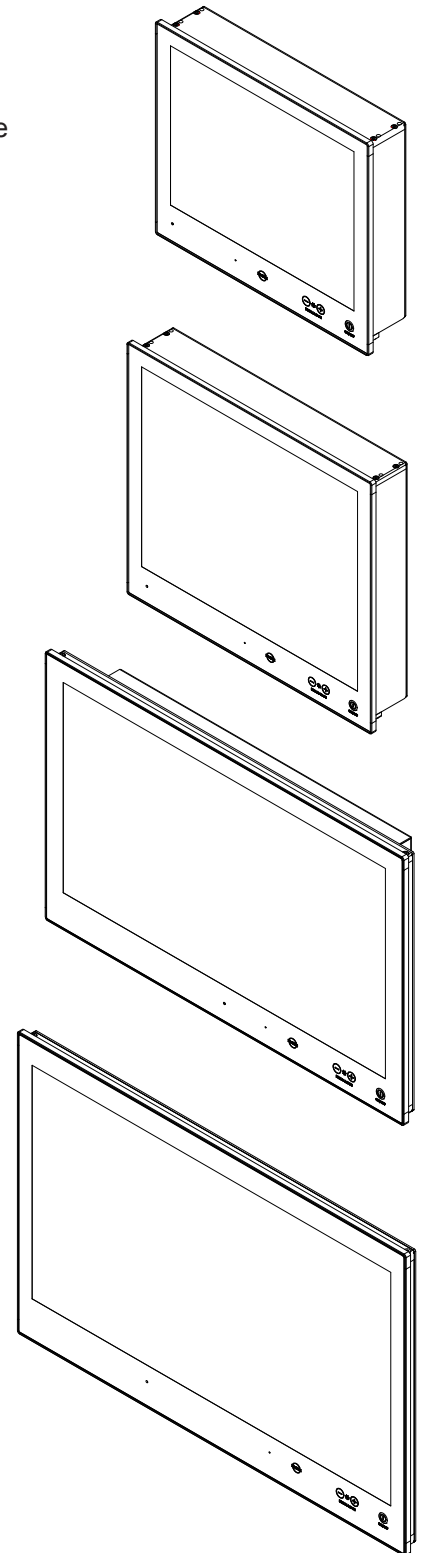





Product Labeling

Introduction

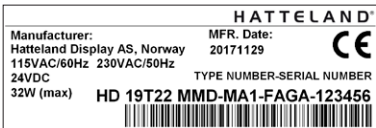
This section details the locations, content details and specifications for factory mounted labels for all currently available standard Hatteland Display Maritime Multi Display (MMD) models. This information will in most cases also apply for most Customized Models as well, but may differ based on customer requirements, in that case, please refer to the customized User Manual (paper or electronic version, dependent on customer requirements).

Label Size and Types

ID	Label Layout	Description	Specification
1	 <p>HATTELAND Manufacturer: Hatteland Display AS, Norway 115VAC/60Hz 230VAC/50Hz 24VDC 32W (max) MFR. Date: 20171129 TYPE NUMBER-SERIAL NUMBER HD 19T22 MMD-MA1-FAGA-123456</p>	<p>Type : Serial Number Label Name : Label B Size : 60mm wide x 22mm high (rectangle size) Note: Text content of label will match specifications derived from Data Sheet.</p>	<p>Silver with glue on back, non-tearable and made for thermal transfer printing.</p>
	<p>Please note that typenumber shown above is a generic sample only. May not reflect products mentioned in this manual. Please review actual product S/N label.</p>	<p>Barcode type: CODE128 (used extensively world wide in shipping and packaging industries. The symbology was formerly defined as ISO/IEC 15417:2007.)</p>	
3	 <p>TOUCH SCREEN Technology : PCTS (Projected Capacitive) Touch Controller : HD PCTS USB controller Driver Download : www.hatteland-display.com VSD100564-HD-PCTS</p>	<p>Type : Touch Screen Label Name : Label B Size : 60mm wide x 22mm high (rectangle size) Note: Only present if Touch Screen was part of factory option order.</p>	<p>Silver with glue on back, non-tearable and made for thermal transfer printing.</p>
		<p>Note: Content on label will vary based on Touch Screen type and/or Touch Screen Controller. Label shown to the right is for illustration purposes only!</p>	
4		<p>Type : Warranty Label Size : 30mm wide x 23mm high (oval size)</p>	<p>Tampering proof sticker with glue on back.</p>
5		<p>Type : Quality Control (QC) Label Size : 30mm wide x 23mm high (oval size)</p>	<p>Ordinary sticker with glue on back.</p>

Product Labeling

Label Locations

Number ID and coloring based on “Label Size and Types” table from previous page. All illustrations below is seen from rear (and side where needed) with connectors facing down. Actual labels regarding its size and text orientation vs product size is drawn in. Due to space restrictions on selected units, some labels will be rotated 90 degrees to fit properly. The arrangement of labels may be shifted/stacked differently as it is based on factory options, such as; Touch Screen, but they will be grouped together where possible.

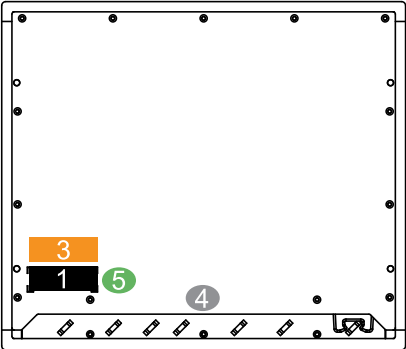
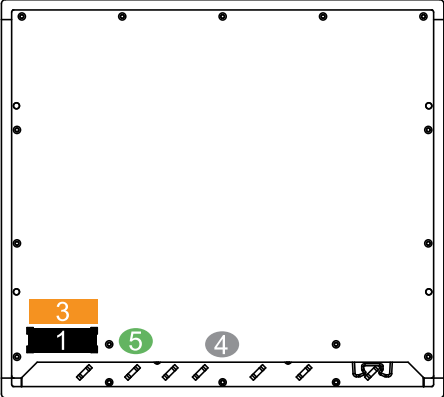
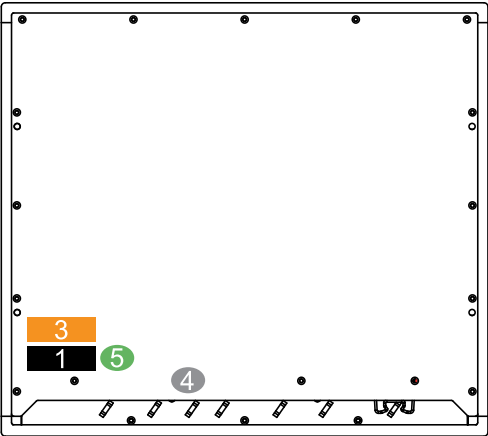
Label Positions	Notes	Applies for Product Range
	<p>Warranty label covers screw. Labels placed on rear.</p>	<p>HD 15T22 MMD-xxx-Fxxx</p>
	<p>Warranty label covers screw. Labels placed on rear.</p>	<p>HD 17T22 MMD-xxx-Fxxx</p>
	<p>Warranty label covers screw. Labels placed on rear.</p>	<p>HD 19T22 MMD-xxx-Fxxx</p>

Product Labeling

	<p>Warranty label covers screw. Labels placed on rear.</p>	<p>HD 24T22 MMD-xxx-Fxxx</p>
	<p>Warranty label covers screw. Labels placed on rear.</p>	<p>HD 26T22 MMD-xxx-Fxxx</p>
	<p>Warranty label covers screw. Labels placed on rear.</p>	<p>HD 27T22 MMD-xxx-Fxxx</p>

Product Labeling

Warranty Label

If you are to perform service on a unit still under warranty, any warranty will be void if this label show signs of removal attempts (re-gluing) or removed completely. This label is located on the back of the product and covers a key screw. This is to aid service departments to determine if there has been any unauthorized service on a unit still under warranty.

Quality Control (QC) Label

This label indicates that the unit is produced, tested and packed according to manufacturer's QA specifications. It will include a Personal ID and signature by the personnell responsible for approving the unit in production, test and warehouse departments.

Serial Number Label Layout (example)

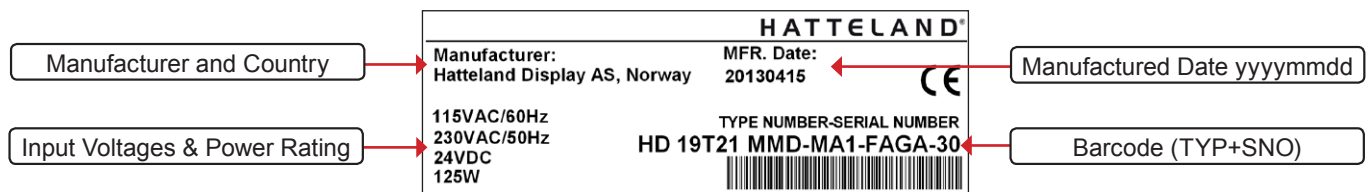

Please note that typenumber shown above is a generic sample only. May not reflect products mentioned in this manual. Please review actual product S/N label.

Touch screen products

Introduction to products with touch screen

Nearly all of our products with touch screen uses Projected Capacitive Touch screen (PCTS), widely used with great success on mobile phones and typical pad devices. PCTS can be equally effective also for marine applications. One of the advantages of PCTS is that it has features seen in both resistive and surface capacitive touch screen technologies.

Multitouch is defined as the ability to recognize two or more simultaneous touch points. Using projected capacitive technology lets us create a more intuitive form of human-device interaction. Touch interface gestures, supported by projected capacitive sensors, can simplify the interface and provide an intuitive user experience that goes beyond the typical "button replacement" found in most simple touch interfaces.

Please review the appropriate Product Data Sheet (in this manual) to determine if PCTS are supported.

The technical benefits of PCT are:

- Very good optical performance (same as surface capacitive)
- Environmentally strong, the touch sensor is inside the product (better than both surface capacitive and resistive)
- Supports Multitouch (Newer Operating System (OS) required in most cases.)
- Excellent readability - light transmission of up to 91% through a standard sensor
- Stability - no drift, therefore no recalibration is required
- Pointing device - works with gloved and ungloved finger
- Resistance to contamination - by harsh cleaning fluids and other noxious substances
- Communicates via USB to external computer or internally

Comparisons between general Touch Technologies used by Hatteland Display:

Technology	Optical Performance	Stable Calibration	Gloves	Water	Durability	Price	Multitouch
Analog Resistive	--	+	++	++	-	++	-
Surface Capacitive	++	-	--	-	+	-	-
Projected Capacitive	++	++	+	+*	++	+	++

*Projected Capacitive (PCTS) / Water: Touch Screen Glass Surface can withstand drip and direct rain, but expect reduced capability, detection and performance if unit are exposed to these factors while powered. Hatteland Display recommends to protect the unit from direct rain or drips if critical touch operations are to be performed. Take necessary steps (if detected or suspected) within the installation environment to prevent accidental touch gestures or presses not performed intentionally by a human operator.

Touch screen products

Touch Screen Drivers and Documentation

All units are shipped with a Documentation and Drivers DVD or CD which contains suitable drivers* for touch screens. (Named MEDIA STD01).

You can also visit our website www.hatteland-display.com/archive to view the same list (or even recently new added products) for our models with touch screen.

Before using the touch screen, it should be calibrated for your system. Please install the 3rd party software* and use the Calibrate function.

For additional touch controller/screen documentation and updated drivers*, please visit the 3rd party manufacturer website as found in the Touch Screen Wizard menu.

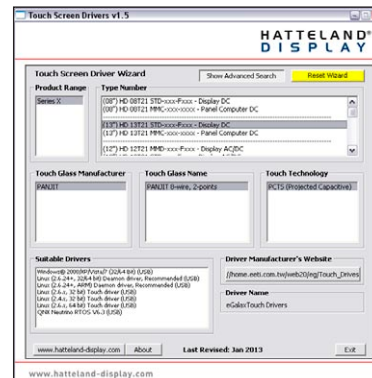

*General Note:

Newer Operating Systems (OS), from year 2011 and above, does not specifically require additional 3rd party drivers in order to operate the touch screen and support "Multitouch". For example; Microsoft® Windows® 7 and above comes with default factory installed Windows HID drivers fully supporting "Multitouch". You may choose to install 3rd party drivers for example during trouble-shooting situations or to review features of the 3rd party software. Hatteland Display suggests that you should use factory default Microsoft® Windows® 7 HID touch drivers in any case possible.

For older Operating Systems (like Microsoft® Windows® XP and older), before year 2011, the OS does not support "Multitouch" technology and the touch screen will just operate as a ordinary single-point touch screen. Additionally to get touch screen working at all in older OS, you need to install 3rd party drivers.

Note that the lack of "Multitouch" support is not dependent on hardware or software/firmware for the controller specifically, but rather dependent on important core functions in the Operating System which are outside control of the 3rd party software.

Summary

Microsoft® Windows® 7 / Microsoft® Windows® 8 / Microsoft® Windows® 8.1 / Microsoft® Windows® 10 IoT

- All HD xxT21 / T22 / MVD units:

- Please use Windows® Generic HID driver, no specific driver needed to use multi-touch.

Microsoft® Windows® 7 32 bit only

- HD 07T22 / HD 13T22 units:

- Please use Windows® Generic HID driver, no specific driver needed to use multi-touch.

Linux (openSUSE® 11.4, Fedora™ 15, Ubuntu® 10.04 LTS, Ubuntu® 12.04 LTS)

- All units:

- Please use Linux Generic Touch driver.

Note: Kernel before 2.6.38: Single touch support.

Note: Kernel above 2.6.38: Multi touch support.

*32bit only available for HD 07T22 / HD 13T22 units. Other units, 32/64 bit supported.

----- Note: Windows® XP is End Of Life -----

Reference: http://www.hatteland-display.com/mails/09_2016_eol.html

Microsoft® Windows® XP

- 24 and 26 inch HD xx21 units:

- Please use Touch Screen Driver Wizard and install PCT Touch Utility, example PtouchUtility-1.0.0.4-150326.exe.

Reference August 2015: http://www.hatteland-display.com/mails/21_2015_ecn.html

Microsoft® Windows® XP

- 8, 12, 13, 15, 17 and 19 inch HD xxT21 units:

- Please use Touch Screen Driver Wizard and install eGalaxTouch Drivers (XPE_5.11.0.9223).

----- Note: Windows® XP is End Of Life -----

This page left intentionally blank



Installation

General Installation Recommendations

First Things First!

IND100148-5 - Rev 04

ATTENTION!
To prevent damage to chassis and glass, please review the illustrations !

CORRECT HANDLING!

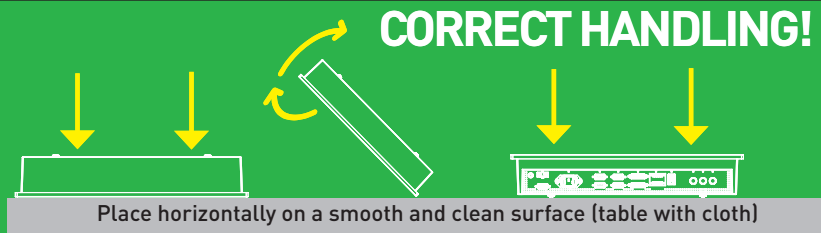

Place horizontally on a smooth and clean surface (table with cloth)

WRONG HANDLING!



Do not stress the corners, nor place it on a coarse and/or dirty surface

Humidity Exposure Notice!
Applies for non-bonded product only: If exposed to humidity in combination with temperature variations, product might show condensation on the glass (inside and outside).
Inside condensation can be removed by power on the product and set brightness to 100%. Within minutes the internal temperature rise will remove condensation.

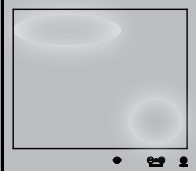

Installation and mounting

1. Most of our products are intended for various methods of installation or mounting (panel mounting, bracket mounting, ceiling/wall, console mounting etc.); for details, please see the relevant mechanical drawings.
2. Adequate ventilation is a necessary prerequisite for the life of the product. The air inlet and outlet openings must definitely be kept clear; coverings which restrict ventilation are not permissible.
3. Generally, do not install the unit in a horizontal position (laying down), as this will cause heat to build up inside the unit which will damage the LCD Panel. To prevent this problem we recommend installing the unit in a vertical position (± 30 degrees) to improve the airflow through the unit.
4. To further improve the thermal situation we recommend to use forced air passing by the product. In some cases, convection based cooling can create "heat zones" around the product. This may be required in high temperature applications and also when there is reason to expect temperature problems due to non-optimal way of mounting.
5. Exposure to extreme direct sunlight can cause a considerable increase in the temperature of the unit, and might under certain circumstances lead to overtemperature. This point should already be taken into consideration when the bridge equipment is being planned (sun shades, distance from the windows, ventilation, etc.). To maximize product life, it is recommended to use Hatteland Display's Sun Covers when the product is not in use. Long term direct sun exposure might have cosmetic impacts on the product.
6. Space necessary for ventilation, for cable inlets, for the operating procedures and for maintenance, must be provided.
7. If the push buttons of the product are not illuminated, an external, dimmable illumination (IEC 60945 Ed. 4, 4.2.2.3, e.g. Goose neck light) is required for navigational use. The illumination shall be dazzle-free and adjustable to extinction.

General Installation Recommendations

8. Information about necessary pull-relievers for cables is indicated in the Physical Connection section of this manual. Attention must be paid to this information so that cable breaks will not occur, e.g. during service work.
9. Do not paint the product. The surface treatment influences on the excess heat transfer. Painting, labels or other surface treatments that differ from the factory default, might cause overheating.
10. Expose to heavy vibration and acoustic noise might under certain circumstances affect functionality and expected lifetime. This must be considered during system assembly and installation. Mounting position must carefully be selected to avoid any exposure of amplified vibration.

Installation limitations

Due to environmental factors, please review the points noted below.

A: Overheat prevention:

For Maritime Multi Computer (MMC, Panel Computers) it is advised that you do not mount the unit in a vertical angle lower than ± 30 degrees, as noted in point 3 (previous section), i.e. flat mounting of the unit. This is to prevent both overheating the unit as well as ensure proper cooling airflow to sustain long-life and stable operation. Panel Computer units generate more heat than regular Display units naturally because of CPU and mainboard chips.

B: Glass Display Control™ (GDC) front glass touch buttons:

As this uses Projected Capacitive technology (instead of conventional hard physical buttons and knobs), the touch controller can react and are sensitive to raindrops (for outdoor installations). To ensure that raindrops do not stay on the unit's flat glass surface, please do not mount the unit in a vertical angle lower than ± 30 degrees, i.e. flat mounting of the unit. This is to prevent accidental touches that are similar to a human finger (cover area for a x period of seconds) as well as make sure the raindrops are "moving" and slides down off the glass surface.

For Maritime Multi Display (MMD) units (not available for Panel Computers (MMC) units), the angle could potentially be lower as the On Screen Display (OSD) menu offers a "OSD Key outdoor" function with 5 seconds delay before activation on front glass functions. Please review the "OSD Menu Functions" to learn more. In certain situations this might help, but is only suggested as a trouble-shooting tip during installation or during short-term observer use if found suitable. It should not be considered as a definitive trusted solution.

C: Projected Capacitive Technology (PCTouch) MULTITOUCH and in general Touch Screen glass:

For all units with a factory mounted touch screen and for outdoor use especially, please review point B above regarding staying raindrops. Only solution to this situation is not to mount the unit in a vertical angle lower than ± 30 degrees, i.e. flat mounting of the unit to ensure touch screen is not activated and accidentally automatically chooses functions in your running chart, radar or other software installed.

D: General rule for console mounted units:

To ensure proper cooling airflow, long-life and stable operation for all units, please make sure that the console casing have either fans or decent ventilation holes to prevent overheating inside the console due to the combined temperature of both Display or Panel Computer units together with other electronic instruments. A general rule is to make sure the console casing is capable of expelling "worst case scenario" in respect of the "Max Power Consumption" of all devices installed. Please review also point 2, 5, 6 and 9 (previous section) for additional information and installation tips.

General Installation Recommendations

General mounting instructions

1. The useful life of the components of all Electronics Units generally decreases with increasing ambient temperature; it is therefore advisable to install such units in air-conditioned rooms. If there are no such facilities these rooms must at least be dry, adequately ventilated and kept at a suitable temperature in order to prevent the formation of condensation inside the display unit.
2. With most Electronic Units, cooling takes place via the surface of the casing. The cooling must not be impaired by partial covering of the unit or by installation of the unit in a confined cabinet.
3. In the area of the wheel house, the distance of each electronics unit from the magnetic standard compass or the magnetic steering compass must not be less than the permitted magnetic protection distance. This distance is measured from the centre of the magnetic system of the compass to the nearest point on the corresponding unit concerned.
4. Units which are to be used on the bridge wing must be installed inside the "wing control console" protected against the weather. In order to avoid misting of the viewing screen, a 25 ... 50 W console-heating (power depending on the volume) is recommended.
5. When selecting the site of a display unit, the maximum cable lengths have to be considered.
6. When a product is being installed, the surface base or bulkhead must be checked to ensure that it is flat in order to avoid twisting of the unit when the fixing screws are tightened, because such twisting would impair mechanical functions. Any unevenness should be compensated for by means of spacing-washers.
7. This Product shall be grounded to protective Earth. For AC Power cables this is done through the ground wire in the connector, for DC input the ground bolt shall be used. A shorter and thicker cable gives better grounding. A 6mm² is recommended, but a 4mm² or even 2.5mm² can be used for this purpose
8. Transportation damage, even if apparently insignificant at first glance, must immediately be examined and be reported to the freight carrier. The moment of setting-to-work of the equipment is too late, not only for reporting the damage but also for the supply of replacements.
9. The classification is only valid for approved mounting brackets provided by Hatteland Display. The unit shall be mounted stand-alone without any devices or loose parts placed at or nearby the unit. Any other type of mounting might require test and re-classification.

General Installation Recommendations

Ergonomics

1. The front surface of the display glass has an anti-reflective (AR) coating which can be scratched and damaged with improper cleaning. It is recommended to use only 90+% pure Isopropyl alcohol (Isopropanol) and a soft fabric cloth for this first cleaning. Fold a cloth into a small pad, dampen the cloth with alcohol, and wipe the glass from one edge to the other in one direction with one continuous motion. The product glass will require cleaning as needed. The soft cloth & alcohol wipe is recommended to clean fingerprints and oils off the glass. Water stains (including coffee, tea & coke) should be first cleaned off the glass with a soft fabric cloth wet with water, immediately followed with wiping using an alcohol wetted cloth.
2. Adjust the unit height so that the top of the screen is at or below eye level. Your eyes should look slightly downwards when viewing the middle of the screen.
3. Adjust screen inclination to remain gaze angle to the centre of the screen approximately perpendicular to the line of gaze.
4. When products are to be operated both from a sitting position and from a standing position, a screen inclination of about 30° to 40° (from a vertical plane) has turned out to be favourable.
5. The brightness of displays is limited. Sunlight passing directly through the bridge windows - or its reflection - which falls upon the screen workplaces must be reduced by suitable means (negatively inclined window surfaces, venetian blinds, distance from the windows, dark colouring of the deckhead). However, units can be offered with optical enhanced technology and/or High Bright panels to reduce reflections and are viewable in direct sun light, but as a general rule the units at the bridge wing area is recommended to be installed or mounted by suitable alignment or bulkhead / deckhead mounting in such a way that reflections of light from the front pane of the display are not directed into the observer's viewing direction.
6. The use of ordinary commercial filter plates or filter films is not permitted for items of equipment that require approval (by optical effects, "aids" of that kind can suppress small radar targets, for example).
7. For ECDIS applications, the minimum recommended viewing distance are as follows:
(IEC62288, Part 7.5 Screen resolution)

17 inch = 907mm	19 inch = 1010mm	24 inch = 951mm	26 inch = 985mm	27 inch = 1070mm	
-----------------	------------------	-----------------	-----------------	------------------	--

General Installation Recommendations

Cables

Use only high quality shielded signal cables.

Cable Entries & Connectors (Marked area)

Illustration below for smallest/largest sizes only.

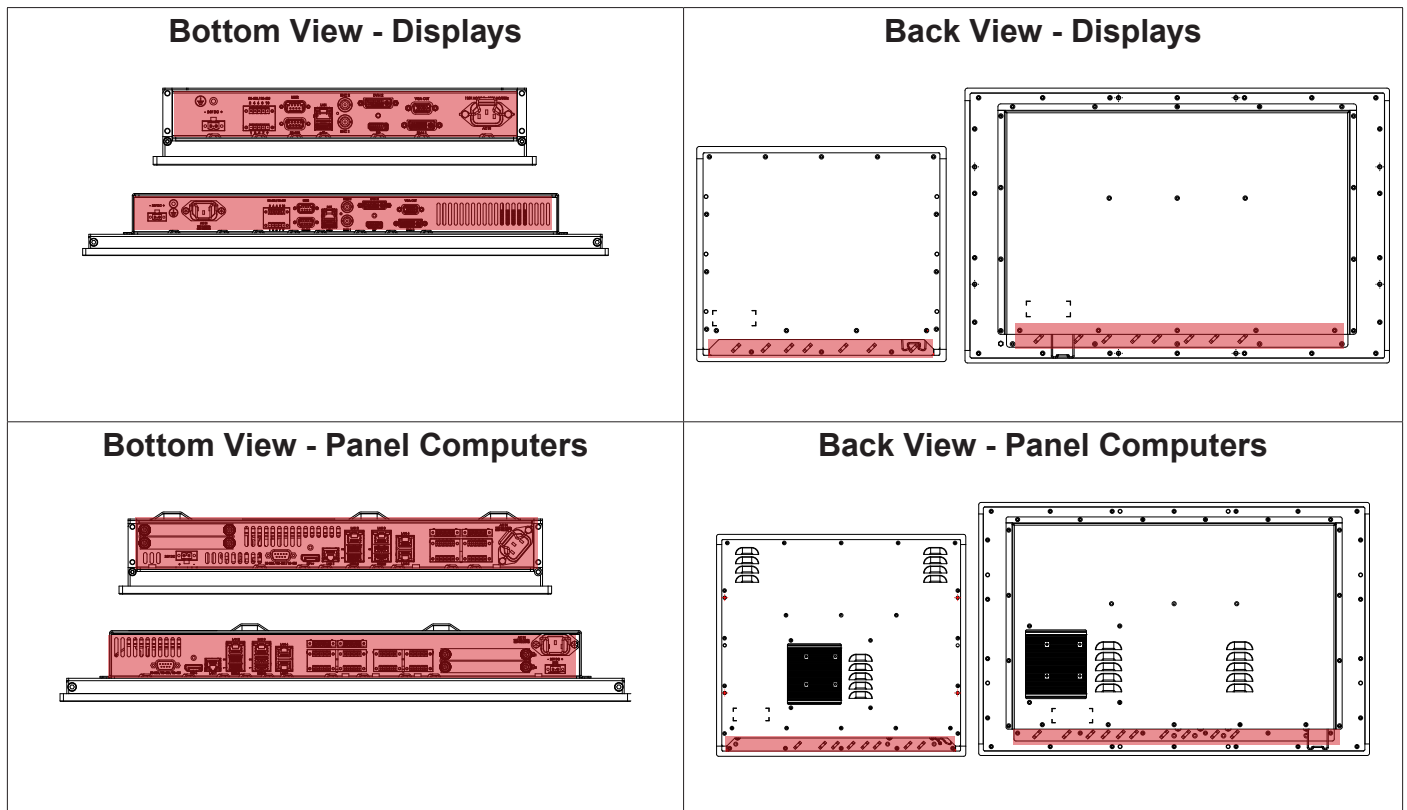

Maximum Cable Length

Any cable should generally be kept as short as possible to provide a high quality input/output. The maximum signal cable length will depend on the signal resolution and frequency, but also on the quality of the signal output from the computer/radar.

General Installation Recommendations

Housing / Terminal Block Connector Overview

Housing / Terminal Block connectors are available in different sizes (example 2-pin, 4-pin, 5-pin) which plugs into the connector area of the unit. They are mounted by factory default and delivered with the unit. The housing / terminal block connectors have steering rails, which ensures that it can not be mounted wrong. The color of these connectors may vary between black, green and orange depending on manufacturer. You may use approved equivalents of these connectors, but note that warranty will be void if any damage would occur to either the unit's original PCB terminal socket connector or inside the unit (electronic components, boards etc.). The table below is applicable for any Series X products, such as Display and Panel Computers, including newer type of Stand-Alone Computers.

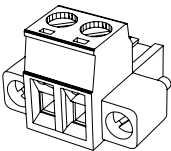
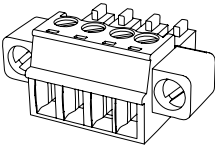
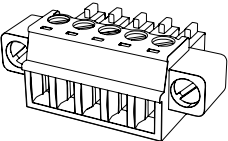
Illustration	Pins	Manufacturer Details	Connector used for module
	2-pin	MSTB 2,5/ 2-STF-5,08 BK Screwdriver: SZS 0,6x3,5, slot-headed. Tightening torque min. 0.5 Nm. Tightening torque max 0.6 Nm.	• DC Power IN (24VDC) - Single Input Identified on Hatteland Display product data sheet as: "Terminal Block 5.08"
L Reference: http://catalog.phoenixcontact.net/phoenix/treeViewClick.do?reloadFrame=true&UID=1961986			
	4-pin	BCZ 3.81/04/180F SN BK BX Screwdriver: 0.4x2.5mm DIN 5264. Tightening torque min.. 0.2 Nm. Tightening torque max. 0.25 Nm.	• CAN Interface (ZIA0001310-B) Identified on Hatteland Display product data sheet as: "Terminal Block 3.81"
L Reference: http://catalog.weidmueller.com/catalog/Start.do?localeId=en&ObjectID=1792970000			
	5-pin	MC 1,5/ 5-STF-3,81 Screwdriver: SZS 0,4X2,5mm VDE, slot-headed. Tightening torque min. 0.22 Nm. Tightening torque max 0.25 Nm.	• RS-422 / RS-485 NMEA (PCA100293-1 / Q170 IO) • Digital Input/Output (PCA100297-1 / Q170 IO) Identified on Hatteland Display product data sheet as: "Terminal Block 3.81"
L Reference: http://catalog.phoenixcontact.net/phoenix/treeViewClick.do?reloadFrame=true&UID=1827732			

General Installation Recommendations

If your installation require additional cable fasteners support, please visit and purchase directly from manufacturer: Illustrations below are approximate, actual Housing and Hood may deviate slightly, but function remains the same.

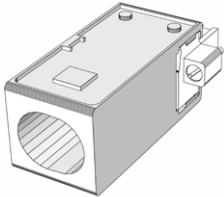
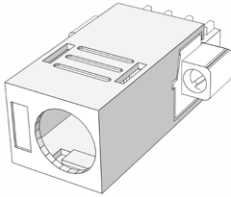
Cable Housing - Illustration	Cover Hood - Illustration
 <p data-bbox="309 568 584 627">KGG-MSTB 2,5/ 2 (2-pin) KGG-MC 1,5/ 5 (5-pin)</p>	 <p data-bbox="986 562 1310 620">BCZ 3.81 AH04 BK BX (4-pin) BCZ 3.81 AH05 BK BX (5-pin)</p>
<p data-bbox="102 633 316 658">For 2-pin and 5-pin: https://www.phoenixcontact.com/online/portal/us?uri=pxc-oc-itemdetail:pid=1803934&library=usen&pck=P-11-02-01&tab=1 https://www.phoenixcontact.com/online/portal/us?uri=pxc-oc-itemdetail:pid=1834372&library=usen&pck=P-11-02-01&tab=1</p> <p data-bbox="102 734 309 761">For 4-pin and 5-pin: http://catalog.weidmueller.com/procat/Product.jsp?sessionId=B040D5EB6832629E567C884809DF6C1?productId=(%5b1005290000%5d) http://catalog.weidmueller.com/procat/Product.jsp?sessionId=D399022A1B3211C0146BCBE716D93211?productId=(%5b1005300000%5d)</p>	

Configuring Housing / Terminal Block connectors

Below is a brief illustration that might be useful during configuration and installation of such connectors. You will need suitable pre-configured cable(s) and tools to configure the connector(s) and cable(s) that are present in your installation environment. Below is a sample procedure for a 2-pin DC power connector. The procedure is the same for other connectors of this type as listed in table above. Unit used as illustration below is for reference only.

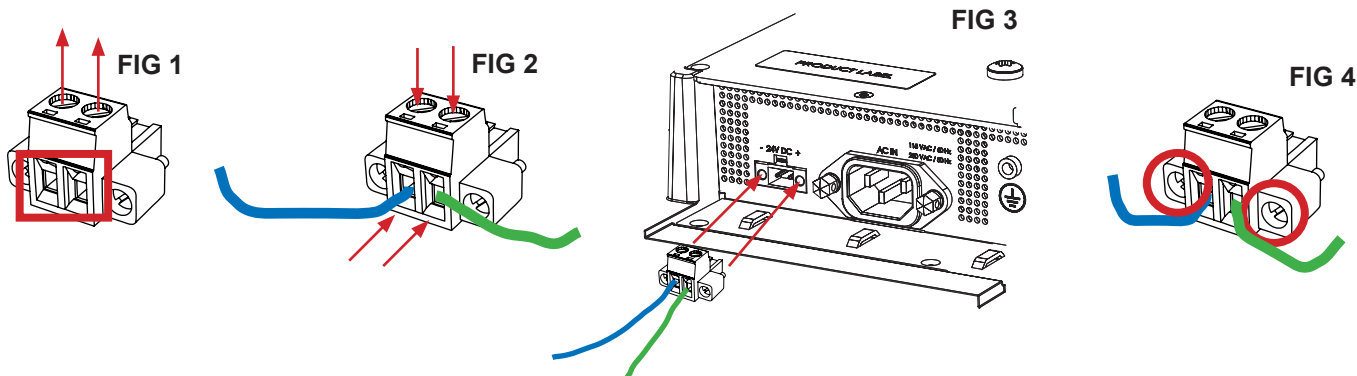

FIG 1: Unscrew (from top) or make sure that the screw terminal (square area) are fully open, so you can secure the inserted cables correctly to the loose housing connector (it may already be plugged into the unit as per factory installation).

FIG 2: Insert cables* (from front) and screw / secure the cables by turning the screw on top of the housing to secure the cables properly. Check that the cables is firmly in place and do not appear loose or falls out when pulling gently.

**Note: Required polarization verification (for instance -/+ for DC power input) should conform with the markings on the connector area of the unit. Ignoring the markings on the unit or its add-on modules might damage the unit and/or external equipment in which end, warranty will be void.*

FIG 3: Plug the housing into the appropriate connector area of the unit (glass should be facing down) and check again that the cables secured conforms with the markings on the connector area of the unit. Finalize the installation by fasten the screws located in front on each side of the housing connector (**FIG 4**).

Installation Procedures

Panel / Console Mounting Bracket Kit for 15, 17 and 19 inch

You need: Hex tool (6mm), 2 pcs of HD CMB SX2-A1 Kit (included in delivery). Procedure suitable for: Display and Panel Computers. Brackets are EN60945 Tested. 19 inch Maritime Multi Display (MMD) used as example below, but procedure applies the same for all 15 and 17 inch Display and Panel Computer units.



Attention: A suitable pre-cut panel cutout should be made prior to mounting. Do not force the unit into the panel cutout as it might break the outer glass or scratch the chassis on the unit. Make sure that the panel cutout is not too tight for the unit. Please disconnect ALL cables before proceeding. Please re-check the relevant and required panel cutout measurements if unsure.

▼ 1: Mount one of the flat brackets on any side on rear of unit first with 3 x M5x12 Countersunk Hex screws as illustrated and fasten it using Torque Force xxNm

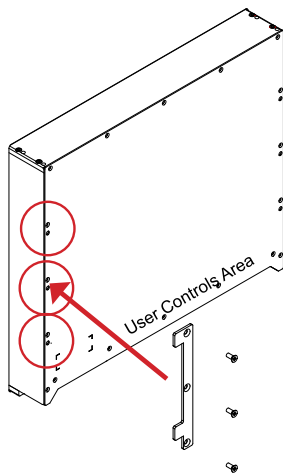

▼ 2: Tilt the unit 45 degree to allow the flat bracket to enter cutout first, then tilt it back 45 degree and slide the entire unit into the cutout evenly and carefully. User Controls and Connector Area should be facing downwards.

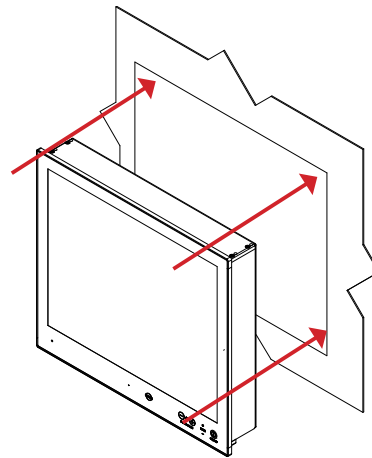

▼ 3: Once unit is in place, mount the other flat bracket on the other side with 3 x M5x12 Countersunk Hex screws as illustrated and fasten it using Torque Force xxNm

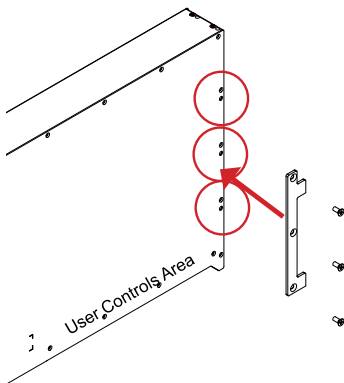

▼ 4: Prepare 4 pcs of Thumb screw and Mounting Socket Nut in separate form as illustrated below.

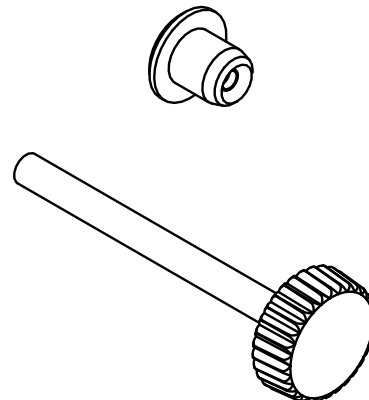

Installation Procedures

▼ 5: Mount the Thumb Screw and Mounting Socket Nut through each of the flat brackets threaded holes as illustrated and fasten the Mounting Nut tight at the end.

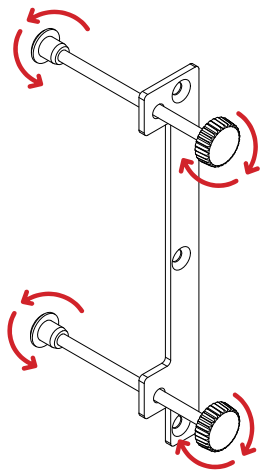

▼ 6: Finally, in a even way fasten each of the 4 Thumb Screws to securely fasten the unit to the rear of the Panel Cutout.

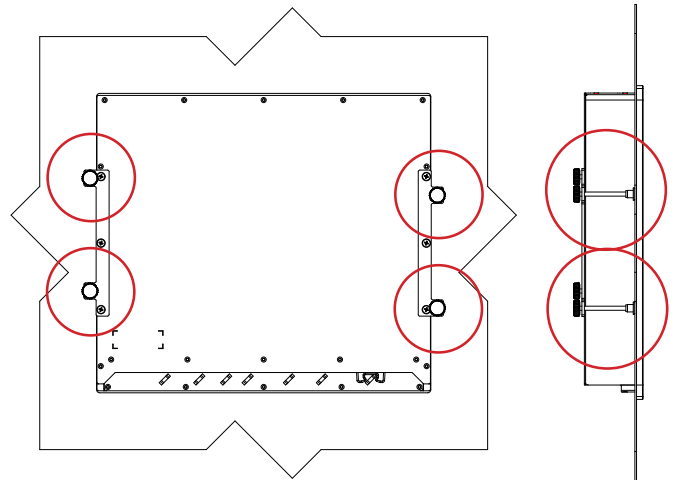

▼ 7: The Console Mounting Kit also allow to edge-to-edge mounting of two units, due to the intersection design of the flat brackets on the rear. Example below illustrates the intersection.

Front View

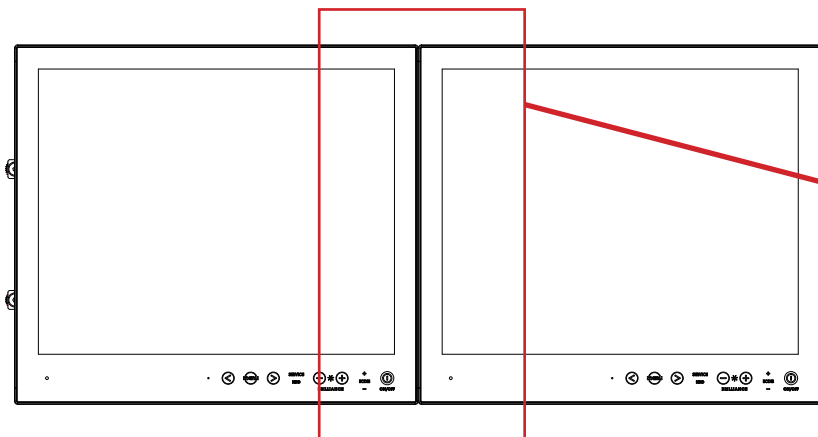

Rear Details

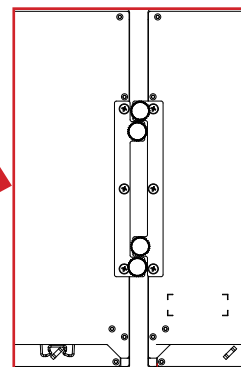

Installation Procedures

Panel Cutout / Console Mounting Bracket Kit for 24 and 27 inch

You need: Torx T25 tool, 1 pcs of HD CMB SX2-E1 kit (included in delivery).

Procedure suitable for: Display and Panel Computers Series X Generation 2 range. Brackets are EN60945 Tested.



Attention: A suitable pre-cut panel cutout should be made prior to mounting. Do not force the unit into the panel cutout as it might break the outer glass or scratch the chassis on the unit. Make sure that the panel cutout is not too tight for the unit. Please disconnect ALL cables before proceeding. Please re-check the relevant and required panel cutout measurements if unsure.

▼ 1: Slide the unit into the cutout carefully. User Controls and Connector Area should be facing downwards.

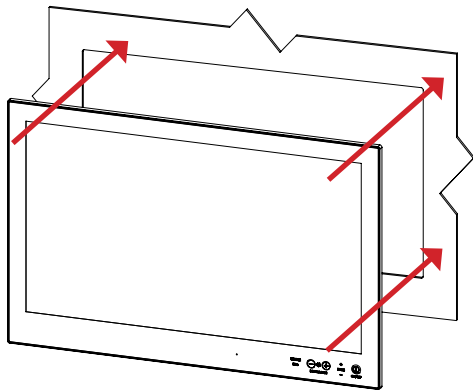

▼ 2: Make sure you are aware that brackets should be mounted on TOP, LEFT, RIGHT and BOTTOM sides. Note that the [B] bracket is different than the [A] brackets and mounted near the connectors. See closeup of details.

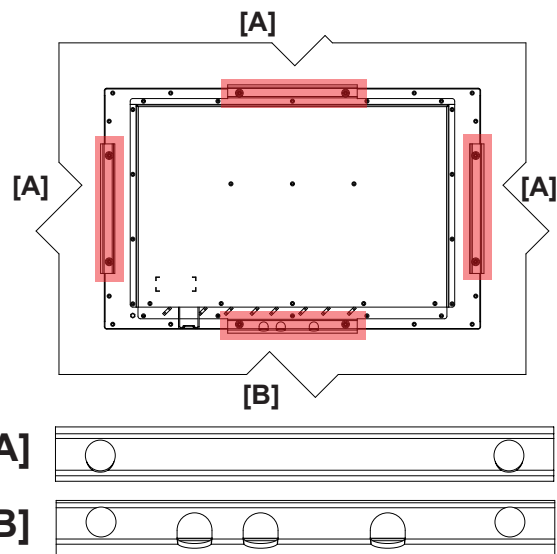

▼ 3: Secure each bracket with the provided M5x16 screws and C-Washers as illustrated below. Make sure you do it equally and even for all 4 sides. Use Torque Force 3.75Nm, 2 screws and 2 washers pr. bracket. Note the orientation of brackets before you begin.

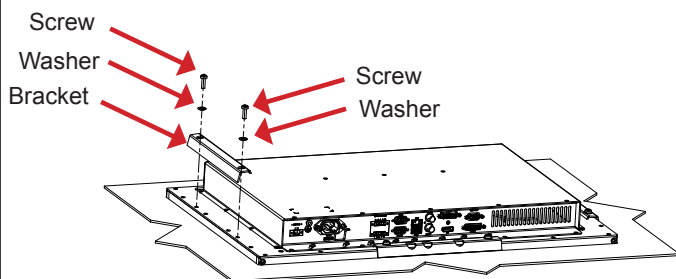

▼ 4: Review closeup of the mounting of brackets with screws and C-Washers in place. Seen from bottom side.

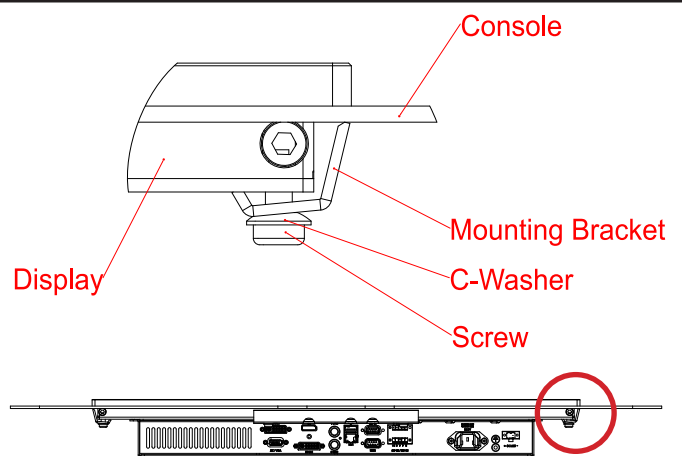

Installation Procedures

Panel Cutout / Console Mounting Bracket Kit for 26 inch

You need: Torx T25 tool, 1 pcs of HD CMB SX2-F1 kit (included in delivery).

Procedure suitable for: Display and Panel Computers Series X Generation 2 range. Brackets are EN60945 Tested.



Attention: A suitable pre-cut panel cutout should be made prior to mounting. Do not force the unit into the panel cutout as it might break the outer glass or scratch the chassis on the unit. Make sure that the panel cutout is not too tight for the unit. Please disconnect ALL cables before proceeding. Please re-check the relevant and required panel cutout measurements if unsure.

▼ 1: Slide the unit into the cutout carefully. User Controls and Connector Area should be facing downwards.

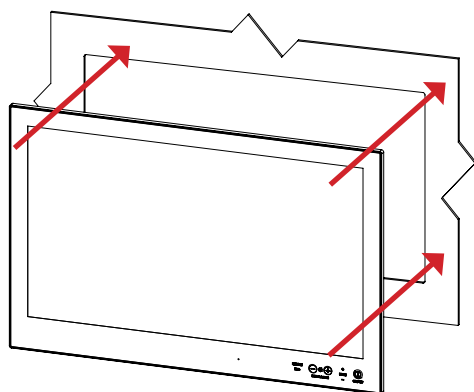

▼ 2: Place and mount the 4 x brackets as illustrated below.

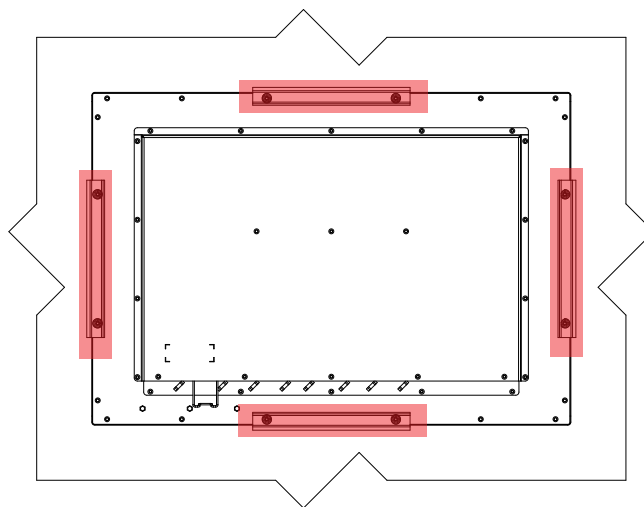

▼ 3: Secure each bracket with the provided M5x16 screws and C-Washers as illustrated below. Make sure you do it equally and even for all 4 sides. Use Torque Force 3.75Nm, 2 screws and 2 washers pr. bracket. Note the orientation of brackets before you begin.

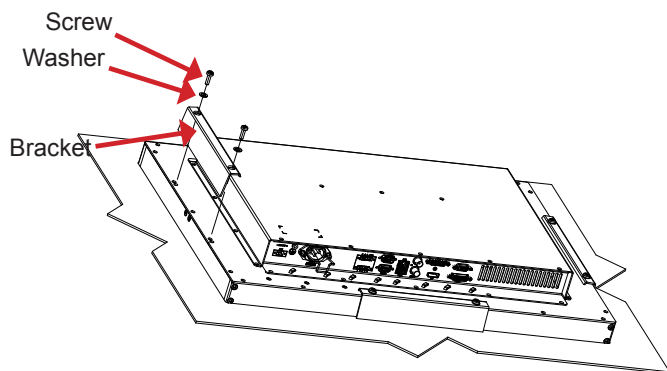

▼ 4: Review closeup of the mounting of brackets with screws and C-Washers in place. Seen from bottom side.

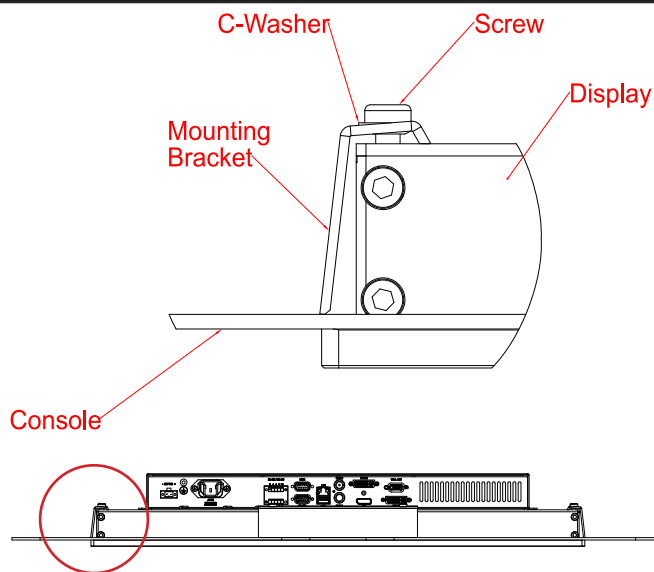

Installation Procedures

Mounting Bracket, Table / Desktop / Ceiling - 15, 17 and 19 inch

Procedure suitable for: Display (MMD) and Panel Computer (MMC) Series X Generation 2 (G2) product ranges.

19 inch Maritime Multi Display (MMD) used as example below, but procedure applies the same for all 15 and 17 inch Display and Panel Computer units.

You need:

- M3 Unbrako® Hex Key tool (not included with delivery).
- Fasteners (6 pcs M6) for mounting complete unit onto table or desktop location (not included with delivery).
- 1 pcs of HD TMB SX2-A1 Mounting Bracket Kit (including pre-mounted 6 x M6x6mm Set Socket Screws).



Attention: Please disconnect ALL cables before proceeding. Please review User Manual or visit www.hatteland-display.com for Technical Drawings regarding measurements for both main unit and Mounting Brackets.

▼ 1: Place the unit on a dry, flat, clean, soft surface (i.e. table) with the glass front facing down as illustrated. Connector area should be facing downwards from you.

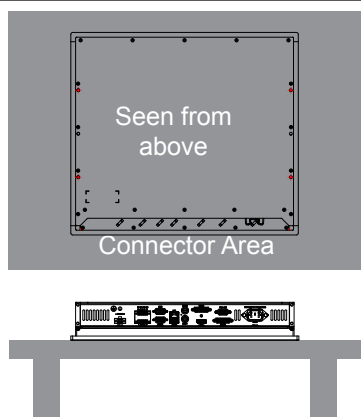

▼ 2: The two bracket pieces comes pre-mounted as shown below. Both sides are identical. Prepare the drilling, location of holes indicated in the footprint below. Drill 6 pcs of 6mm holes in your table/desktop location.

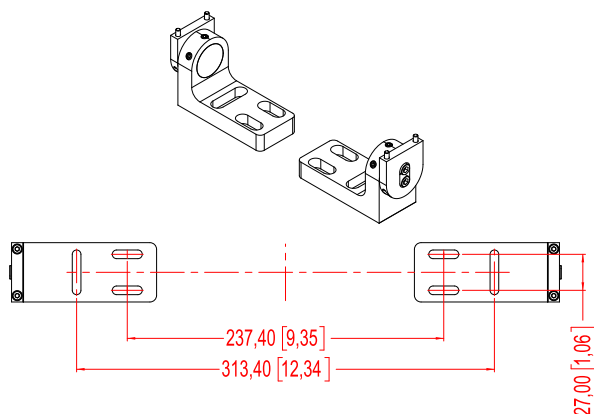

▼ 3: Identify the 3 x Set Socket Screw (M6x6mm) and slightly loosen two of them, now tilt the upper part until you reach an approximate position you need and tighten them slightly.

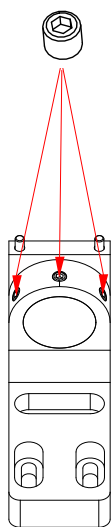

▼ 4: Mount the brackets onto unit as indicated with 2 pcs M4x35 DIN912 screws (included) on both sides. Use Torque Force 2Nm.

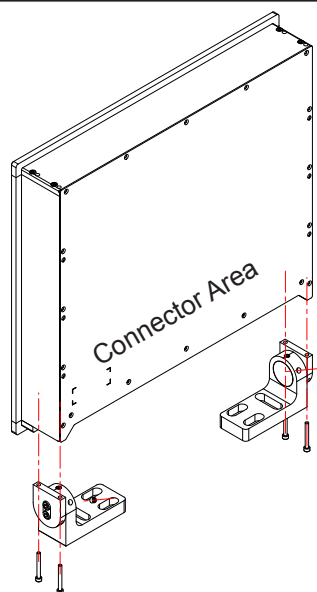

Installation Procedures

▼ 5: Please note the Factory Mounted Torx screws on both bracket sides, THESE ARE NOT TO BE ADJUSTED OR LOOSENED!

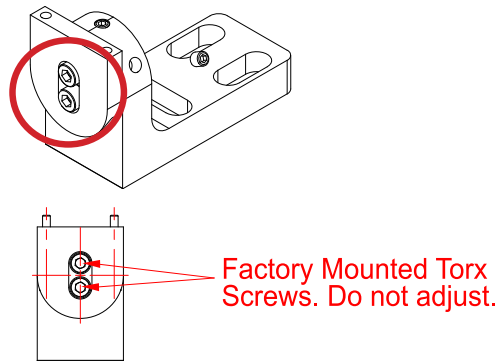

▼ 6: Fasten the complete unit to your table/desktop location, and tilt it into the desired position. Locate the Set Socket Screws on both brackets described in step 3. Secure all 3 Set Top Screws on both sides, use Torque Force 7Nm on all. If you need to re-adjust the tilting later, place your hand on top of the Display/Panel Computer unit to keep it steady, and loosen minimum two of any Set Top Screws on both brackets, adjust unit into new tilting angle, and fasten the Set Top Screws again. Verify that the unit does not tilt by itself and appear fixed in-place.

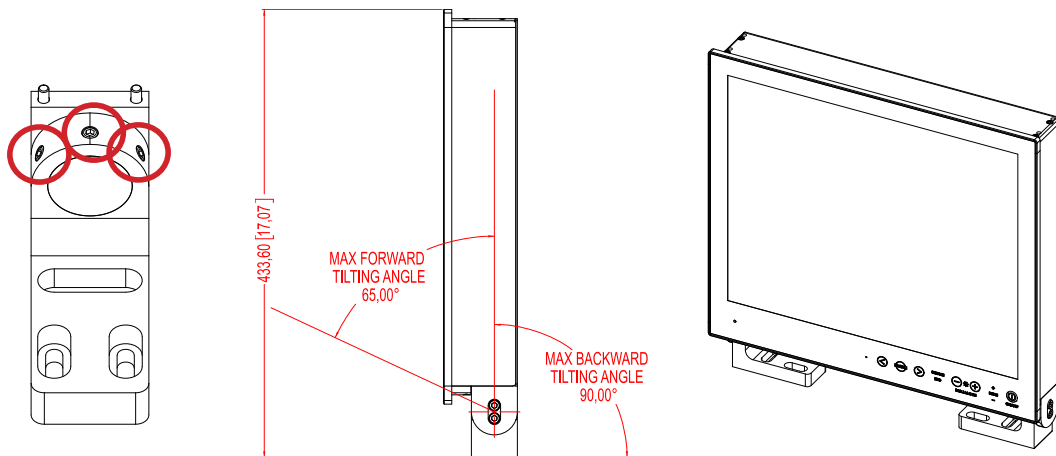

▼ ▼ Alternative Mounting: Depending on installation needs, you may mount the complete unit in ceiling in two different ways.

Upside Down Position: User Controls will be upside down, cables go straight up. You may configure Glass Display Control™ (GDC) LED symbols to show or not, since symbols will be seen upside down. Displayed image needs to be flipped vertically. Review the appropriate SCOM manuals ("Glass Display Control™ (GDC) LED & Button operations" section).

Normal Position: User Controls readable, no image flip needed, cables has to bend up or go straight down.

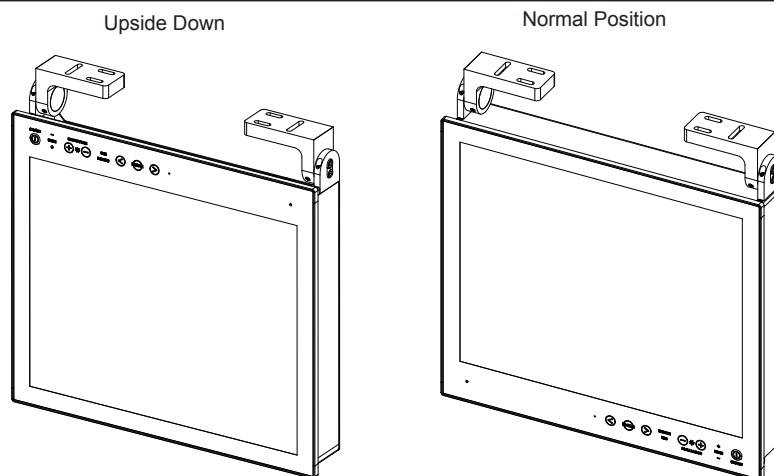

Installation Procedures

Mounting Bracket for Table / Desktop installation - 24, 26 and 27 inch

You need: M5 Unbrako® Hex Key tool and 1 pcs of HD TMB SX1-C1 Mounting Bracket Kit. Fasteners (6 pcs M6) for Table / Desktop location not included. Procedure suitable for: Display and Panel Computers. 24 inch unit used as illustration below, but same procedure apply for 26 and 27 inch units as well.



Attention: A suitable pre-drilled location should be prepared and checked prior to mounting. Please disconnect ALL cables before proceeding. Please review User Manual or visit www.hatteland-display.com for Technical Drawings regarding measurements for both main unit and Mounting Brackets.

▼ 1: Place the unit on a dry, flat, clean, soft surface (i.e. table) with the glass front facing down as illustrated. Connector area should be facing downwards from you.

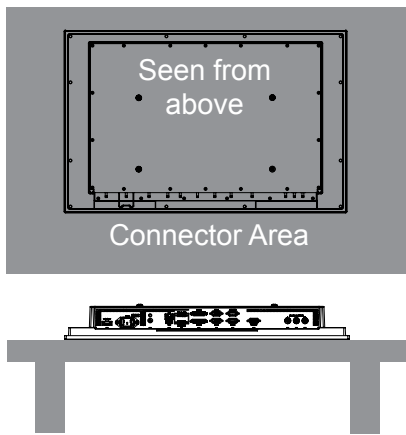

▼ 2: Inspect the mounting holes of brackets. For mounting to a 24 inch unit, please use the **lower holes** as indicated. For mounting to a 26 / 27 inch unit, please use the **upper holes** as indicated.

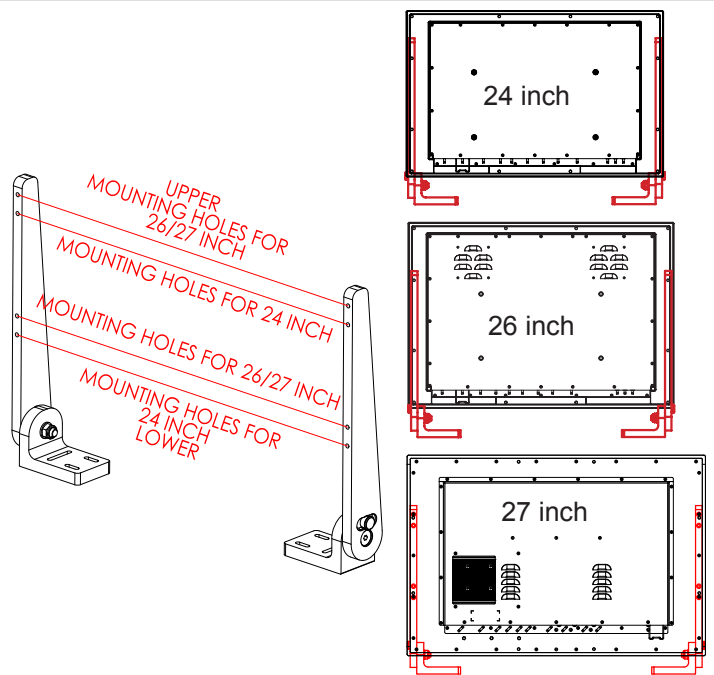

▼ 3: Place one bracket at the time with the mounting holes facing down into the suitable mounting position and fasten with 2 x M5 screws on each bracket. Torque Force 3.5Nm.

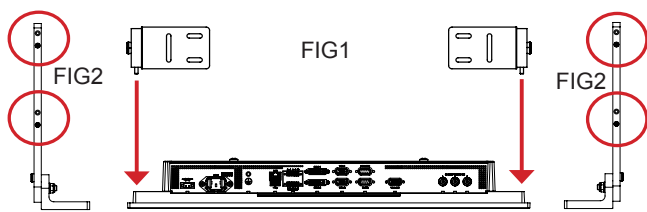

▼ 4: While unit is lying flat on table, check the Tilting Lock Pin position. These can be pulled out by hand, turned 90° (FIG1) and turned back 90° until the Lock Pin automatically clicks into place by a spring (FIG2).

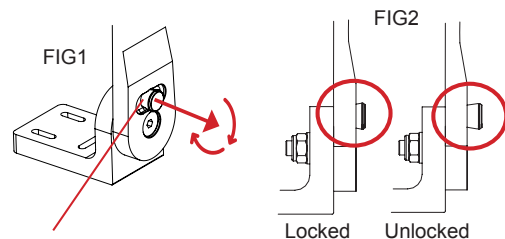

Installation Procedures

▼ 5: You may now mount the unit onto your desired location. It is advised that you unlock the Lock Pin (as shown in step 4), tilt the unit 90° backwards (FIG1) and properly fasten the bracket base into location (FIG2).

NB! Be careful not to break or scratch the edge of the front glass! Then repeat step 4 again until your desired tilting position has been achieved and you have verified that the Lock Pin are in locking position and the unit is firmly attached and does not appear loose (FIG3).

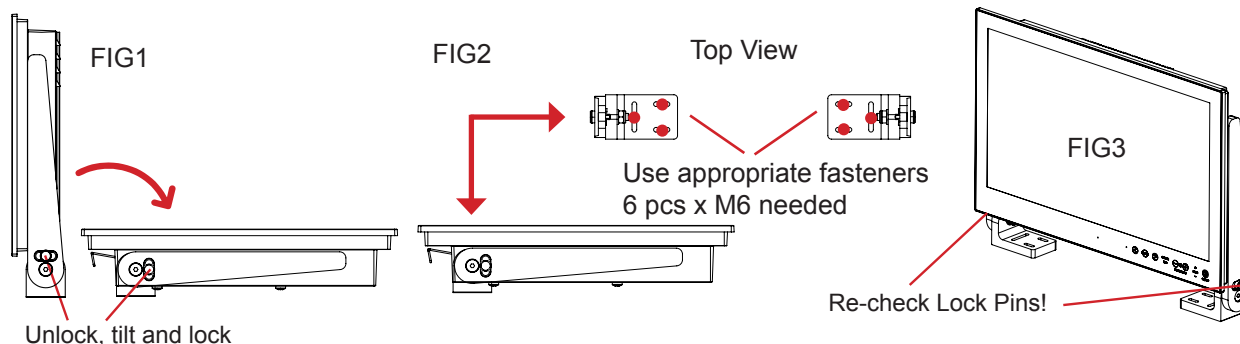

▼ Alternative Mounting: Depending on installation needs, you may mount the complete unit in ceiling in two different ways.

Upside Down Position: User Controls will be upside down, cables go straight up. You may configure Glass Display Control™ (GDC) LED symbols to show or not, since symbols will be seen upside down. Displayed image needs to be flipped vertically. Review the appropriate SCOM manuals (“Glass Display Control™ (GDC) LED & Button operations” section).

Normal Position: User Controls readable, no image flip needed, cables has to bend up or go straight down.

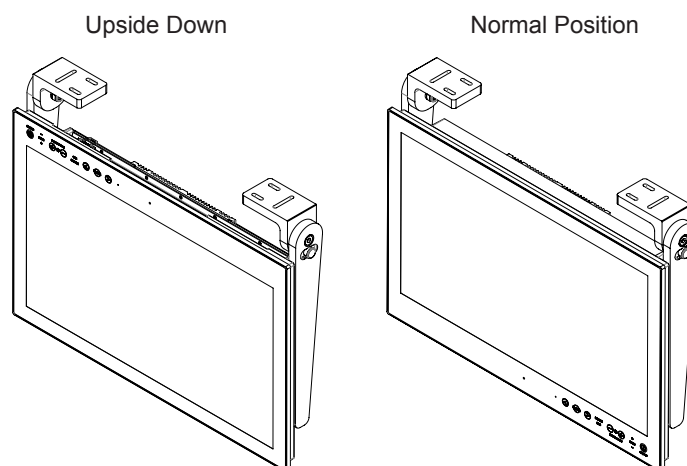

Physical Connections

Connection area of unit (illustration)

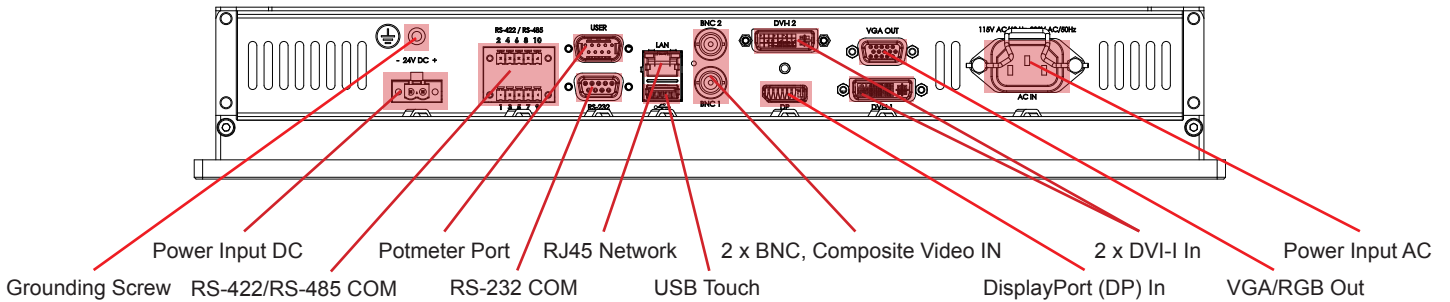

Note: 19 inch unit used as example above, please review specifications for your actual model.

Reduce Cable Tension

To reduce tension of the cables you connect, secure them with a cable tie to the available chassis hinges located near the connectors.

Note: Amount of chassis hinges can vary depending on model.

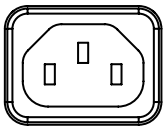
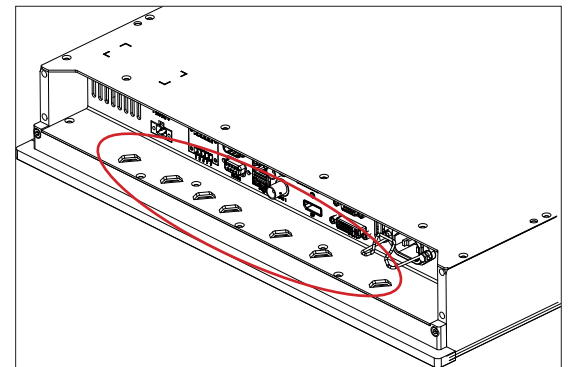

POWER INPUT:

The internal AC power module supports both 115VAC/60Hz and 230VAC/50Hz power input. Please check specifications for your unit.

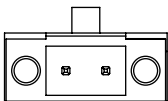

- +

POWER INPUT:

Connect your DC power cable to the 2-pin Terminal Block 5.08 connector. The internal DC power module supports 24VDC. For more information, please review "Housing Connector Overview" earlier in this manual.



GROUNDING SCREW:

Please review "General Installation Chapter", pt. 7 for more information.

Multi-power note: (For units supporting AC & DC input simultaneously)

The unit has a dual input power supply which will accept both AC and DC input. If both inputs are connected, the unit will be powered by AC. If AC is disconnected it will automatically switch over to DC without affecting the operation of the unit. This makes it possible to use AC power as primary power and a 24V battery as secondary power, eliminating the need for expensive UPS systems.

Physical Connections

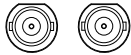

COMPOSITE VIDEO IN 1,2:

Connect a Composite Video signal (PAL/NTSC/SECAM) to any of these 2 x BNC female connectors to allow video feed to be used as Full Screen, Picture-In-Picture (PIP) or Picture-By-Picture (PBP) from i.e. cameras & DVD players in addition to the regular DVI, DP or RGB/VGA (Via adapter) signal input.

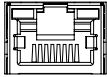

Network/LAN INPUT / OUTPUT (NET A):

Supports 10/100/1000Mbps Ethernet (LAN). Suitable for twisted pair cables CAT.5E. Make sure the network cable connector "clicks" into the RJ-45 connector. This connector will allow remote control via SCOM of the display unit to control common functions like brightness, input source and more.

Hatteland Display's Serial Remote Control Interface (SCOM) protocol document can be downloaded from: <http://www.hatteland-display.com/pdflink/inb100018-6.php>



USB TOUCH:

Connect a TYPE A USB Cable between this connector and your PC. Suitable drivers to install and calibrate the touchscreen are available on the separate installation media delivered with the unit. Port is USB2.0 (<5m).

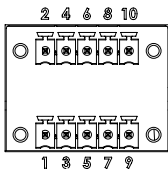

RS-422 / RS-485 COM I/O:

The COM (non-isolated RS-422/485) allows functionality to communicate with serial based equipment including controlling internal buzzer externally. Connect and fasten your cables from your compatible external equipment to the 5-pin Terminal Block 3.81 connector. Please review the "Pinout Assignments" chapter as well as "Housing / Terminal Block Connector Overview" in this manual for more information.

Hatteland Display's Serial Remote Control Interface (SCOM) protocol document can be downloaded from: <http://www.hatteland-display.com/pdflink/inb100018-6.php>

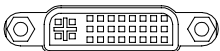

DVI-I IN:

Connect your DVI cable to any of the two DVI-I 29p connector (female). Secure your DVI cable to the hex spacers provided on the unit and make sure you do not bend any of the pins inside the connector. Connect the other end of the cable to the DVI connector on your equipment and secure it.

Important note for DVI signal detection:

Please note that for the operating system to detect DVI signals correctly, the DVI cable MUST be connected physically to the unit during boot up otherwise you may experience a black image. Furthermore certain graphics drivers may need to refresh their device list (often done manually by user - detect devices), while in some cases the Plug-n-Play will automatically detect the DVI signal correctly. Please consult your local technician if you have this behaviour of detection problems when using DVI. In all cases the problem can be solved in the operating system, and this is not a malfunction in the graphic controller for display units.

Physical Connections



DisplayPort (DP) IN:

Connect your DP (male) cable to the DisplayPort (v1.2) 20P connector (female) of the unit. The DP has its own locking mechanism that locks the plug inserted. Make sure the plug “clicks” into place to verify a proper and secure connection.

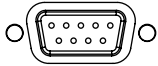

RS-232 COM I/O:

This 9P COM connector provides additional functionality for the unit. The Serial Remote Control features a RS-232 (non-isolated) interface for controlling internal parameters like brightness. You can access most of the parameters available in the OSD menu and with special commands control the unit externally. This COM can also be used to upgrade the firmware for the graphic controller inside the unit which is available on request and through service channels (for qualified personell only). Fasten your external cable to the D-SUB 9P Female connector using the provided screws on the cable housing.

Please review “Management Settings/Communication” in the “OSD Menu Functions” chapter for more information.

Hatteland Display’s Serial Remote Control Interface (SCOM) protocol document can be downloaded from:
<http://www.hatteland-display.com/pdfink/inb100018-6.php>

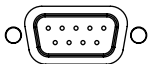

POTMETER INPUT / OUTPUT:

Allows for controlling Brightness of the displayed image on screen by connecting an external remote control to the 9P D-SUB (male) connector which has Potentiometer IN, +5VDC OUT and BRT +/- IN functionality built in. Review the “Pin Assignments” chapter in this manual for more information how to activate this functionality.

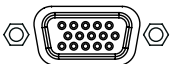

VGA OUT:

VGA OUT enables a direct clone of the incoming VGA signal if using a DVI-I to VGA adapter. Connect the cable to the D-SUB 15P Connector (female) and secure it to the hex spacers provided on the unit. Connect the other end to your equipment and secure it. Note that only DVI-I port #1 supports cloning.

This page left intentionally blank



Operation

User Controls

USER CONTROLS OVERVIEW

The units are designed by using Glass Display Control™ (GDC) touch technology to allow interactivity adjusting brilliance (brightness) and control power on / off with the use of illuminated symbols. Note that these symbols are only visible (backlight illuminated) when suitable power is connected, except power symbol which has a white silk print to indicate its position on the front glass. Further, not all symbols are available depending on factory options and product sizes (where applicable). There is no physical moving knobs, potmeters, wheels or push buttons available as everything is touch surface controlled by Projected Capacitive technology that allows a human finger (including several types of gloves) to control the unit.

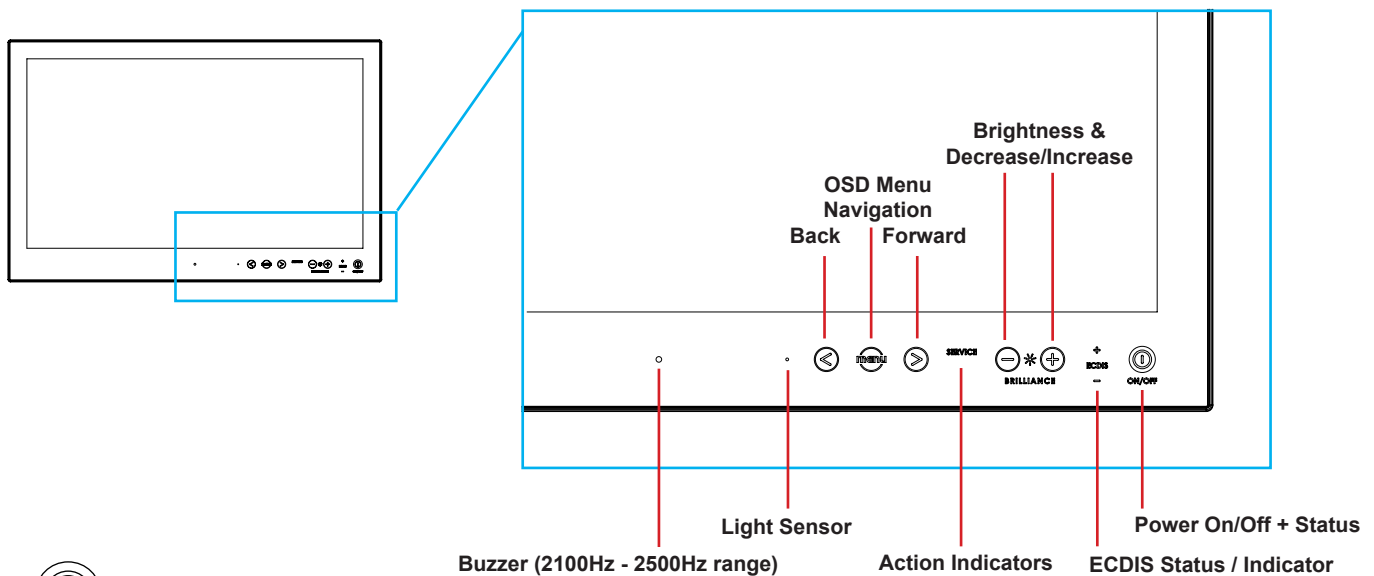

ON/OFF

Power ON/OFF:

This symbol and all text will illuminate in red when suitable power is connected and the unit is turned off. When the unit is on and operating, this symbol will illuminate constantly either in yellow color (signal not recognized/not present and no image on screen) or green color (signal detected and image on screen).

Power ON:

To turn the unit on, verify that the symbol is illuminated in red (indicates suitable power is connected) and touch the power symbol and hold until the the symbol changes to green light/yellow light or a image appears on the screen.

Power OFF:

To turn the unit off, touch the power symbol and hold until it either illuminate/change from green/yellow to red or the image on screen disappears.



OSD Menu, Navigation:

If the OSD (On Screen Display) menu was activated (and is clearly visible on screen), both the "<" and ">" are used to navigate and set options within the OSD menu

To access the main OSD menu, touch anywhere on the "MENU" circle symbol and the OSD menu will clearly be seen as an overlay over the existing displayed image. The complete definition of all the menus and functions are available in the "OSD MENU FUNCTIONS" chapter in this manual.

User Controls

SERVICE

SERVICE

Action Indicators:

= Built in functionality to determine when the unit requires service in order to perform within preset factory standards. This area will illuminate constantly until the unit is powered off.
Note that by touching this symbol no action will be performed or has been assigned.



BRILLIANCE

Brightness Adjust:

Brilliance / Brightness adjustment of the displayed image is adjusted by touching the (-) or (+) illuminated symbols. The entire area of text and symbols are visible as long as the unit is powered. Note that only the (-) and (+) are touch sensitive while the "*" and "BRILLIANCE" symbols are not. The symbols (-) and (+) are also used to change values in the OSD menu when its activated / function selected for adjusting.

+ ECDIS = ECDIS Status / Indicator: (optional factory standard)

For units that has been factory ECDIS calibrated the text "ECDIS" will illuminate in green constantly as long as the unit is powered. The "+" and "-" symbols will illuminate in orange when the Brightness/Brilliance is adjusted either above or below ECDIS factory calibration point.

To be able to stay within ECDIS calibrated range, please assure that both the "+" and "-" are not illuminated in orange color and that "ECDIS" text remains illuminated in green during operation. Note that by touching these symbols no action will be performed or has been assigned.

Note: ECDIS functionality is mostly only suitable for model sizes above 15 inch units.



Light Sensor:

Used to sense level of ambient light in the surrounding environment. The sensor data can be read by suitable software through the Hatteland Display SCOM functionality of the unit and thus can be used to control brightness remotely. Note: This sensor is barely visible for the eye and lies under the glass. It has no illumination behind to indicate it's position. Touching or covering this area will naturally make the sensor data inaccurate and should be avoided!





Buzzer:

Only functional for units ordered with Buzzer functionality. The location of the buzzer hole (physical hole in glass) is barely visible for the eye. Touching this area will naturally mute buzzer sound or in some cases make it lower or change audible frequency. In no circumstances should this area be blocked by either stickers or objects! Please review the "Pinout Assignments" chapter in this manual for controlling the Buzzer functionality.

Note:

In the following "On Screen Display (OSD)" menu chapter, these buttons are referenced as:

	"MENU"
	"(-) Brilliance (+)"
	"(<) Navigation (>)"

OSD Menu Overview

On Screen Display (OSD) Menu Introduction



The OSD menu consists of main menus and submenus which is very easy to navigate through. All functions are explained in-depth later in this user manual. You should prior to using the OSD menu and functions, be sure to familiarize yourself with how to physically access the menu, how to navigate up/down/left/right, how to modify values, exiting menus and more.



Please note: Factory default illustrations only! Available functions, icons and text may deviate slightly from actual OSD menu on your product due to different OSD software configurations and customized solutions.

OSD Keycode / OSD Lock Mode

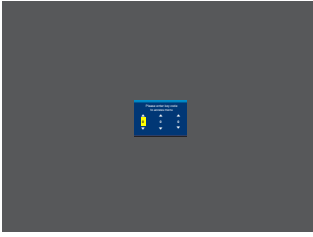
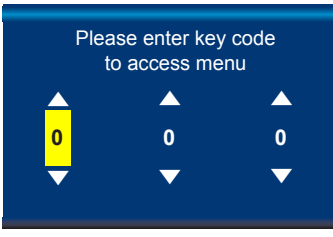
During use, a small requester may pop-up on screen asking you for a “Key Code”. This is a safety feature (due to ECDIS Compliance) that might be predefined in your setup. To quickly understand how to enter a code, navigate and finally access the underlying main menu, simply follow the illustration below. The “Key Code” is factory default set to “321”. If the “Key Code” requester do not appear on screen, you can skip reading this section for now and proceed to the next page.

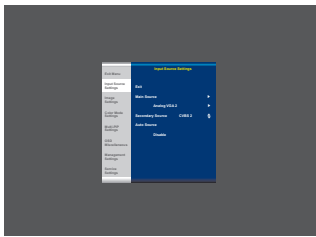
 <p>Active Display Area + Requester</p>	 <p>Close-up of Requester</p>	 <p>Close-up of Requester</p>
<p>1: Typical position of requester on screen. Yellow box indicate number position, default location is always on first number.</p>	<p>2: Enter first number (from 0 to 9). Use “Navigation/Hot Keys” touch buttons to increase/decrease. Number change in real time.</p>	<p>3: Now touch menu button to store first number and proceed to second number. Yellow bar will move its position too.</p>
 <p>Close-up of Requester</p>	 <p>Active Display Area + OSD Menu</p>	
<p>4: Repeat step 2 and 3, until “Key Code” reads “3 2 1” and finally touch menu button to continue.</p>	<p>6: The OSD menu appear by default in the middle of Active Display Area</p>	

After the code was successfully entered you will gain access to the OSD Menu and a multitude of functions will be available for adjusting or reviewing. Please proceed to the next page, where you will learn the differences between the different menu modes and a complete map of all the underlying functions available within.

OSD Menu Overview

OSD “Basic”, “Advanced” & “Service” Menu modes



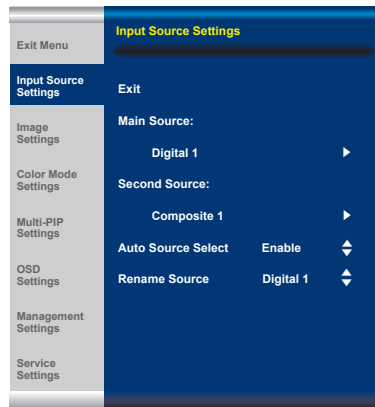

Three OSD Modes are available. The “Basic” Menu mode offers easy and clear access to most commonly used functions. The “Advanced” Menu mode offers a more advanced menu with technical information and is suited for more technical minded users and the “Service” Mode reveals more options in “Service settings” for service purposes. “Advanced” and “Service” mode are password (KeyCode) protected. Password for Advanced Mode is “362”, Password for Service Mode is intentionally only available from Service Partners and our HelpDesk which should only be used by experienced personnell. Please contact your Service Partner or our HelpDesk to retrieve the password.



OSD Menu showing for example “Input Source Settings” chosen in the menu. The left menu bar is visible at all times, while the right section will change based on contents of that submenu. The design and size of OSD menu area does not change, even in any of the “Basic”, “Advanced” and “Service” mode setting.

OSD Visual Feedback (examples)

Throughout all OSD menus there are certain symbols you need to familiarize yourself with. These are to visually indicate that a value can be increased/decreased, accessed, display a Slide Bar Meter or just for information purposes only. All functions with arrows have text based, human readable lists with a start and end choices. A Slider Bar with number beside it will indicate the value has a minimum, current and max limit. All changes in values and lists happen in real time as you touch the menu button and/or touch navigation buttons.

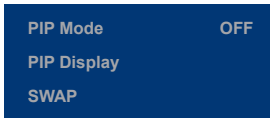
	
Arrow pointing right means that there is a submenu available for this function for further adjustments and functions.	Arrow pointing up/down means that the current choice can be changed in-place from a list that has a start and end.
	
Slider Bar meter indicates the “filling” up based on a minimum and maximum value. The current value is written to the left.	Whenever a function is selected, the item will be visually indicated with a yellow bar behind it. The other choices available will be in white text with no yellow bar behind.
	
Functions displayed in Green Color indicates either the current stored value of the function and sometimes to draw user’s attention towards information about an selected function or its current state.	Functions displayed in gray text means that set of functions may depend on a different option to be turned on or configured first. In this example, “PIP” functions are all unaccessible, since “PIP Mode” is “OFF”.

Note: The examples above are the most common ones displayed. Your menu may have slight different style and colors, depending on firmware, variations and customized solutions, but the logic of operation is the same.

OSD Menu Overview

OSD Menu Structure

In this table all functions within menus and their submenus are shown. Functions that begins with an asterix (*) and in **bold/red font color** style indicates this function/menu is only available during "Advanced" menu mode or during Video CVBS fullscreen. Functions with a ">" in the end, indicates a submenu or list of options will be displayed. Depth of the sub-menus (levels) are identified from 1 to 5.

Input Source Settings

Level 1 (Main Menu)	Level 2	Level 3	Level 4	Level 5
Exit				
Input Source Settings >	< Exit			
	Main Source >	< Exit		
		Digital 1, Digital 2, Analog RGB1, Analog RGB2, Composite 1, Composite 2, Composite 3, DisplayPort1	(Text Displayed)	
	Second Source >	< Exit		
		Digital 1, Digital 2, Analog RGB1, Analog RGB2, Composite 1, Composite 2, Composite 3, DisplayPort1	(Text Displayed)	
	Auto Source Select >	< Exit		
	DVI-I1 Mode	DVI Mode/VGA Mode/Auto Mode		
	DVI-I2 Mode	DVI Mode/VGA Mode/Auto Mode		
	Auto Source Selection	Enable/Disable		
Rename Source >	<On Screen Keyboard Input>			

Image Settings

Level 1 (Main Menu)	Level 2	Level 3	Level 4	Level 5	
Image Settings >	< Exit				
	Auto Position >	(Automatic Action)			
	Auto Color Balance >	No/Yes			
	* Brightness >	(Slider Bar 0~255)			
	* Contrast >	(Slider Bar 0~255)			
	* Saturation >	(Slider Bar 0~255)			
	* Hue >	(Slider Bar 0~255)			
	Sharpness >	(Slider Bar 0~24)			
	Display >	< Exit			
		H. Position >		(Slider Bar 0~100)	
		V. Position >		(Slider Bar 0~100)	
		Clock >		(Slider Bar 0~100)	
		Phase >		(Slider Bar 0~100)	
		Picture Direction >		Select 0/180	
	* Video Setup >	< Exit			
		Main MADI Mode >		Normal, Adaptive, Off	
		Noise Reduction >	< Exit		
	Dynamic NR Mode >			High, Medium, Low, Adaptive, Off	
	MPEG NR Mode >			On, Off	
	Sharpness Noise Coring >			High, Medium, Low, Adaptive, Off	
	Film Mode >		2:2, 3:2, 3:2-2:2, Off		
	DCDi >		On, Off		

OSD Menu Overview

Color Mode Settings

Level 1 (Main Menu)	Level 2	Level 3	Level 4	Level 5
Color Mode Settings >	< Exit			
	Color Temperature >	9300K, 8000K, 6500K > User >	(Automatic Action)	
			< Exit	
			Red >	(Slider Bar 0~255)
			Green >	(Slider Bar 0~255)
			Blue >	(Slider Bar 0~255)
	*Gamma >	No Calibration, Calibration VGA, Calibration DVI, Calibration DisplayPort		

Multi-PIP Settings

Level 1 (Main Menu)	Level 2	Level 3	Level 4	Level 5	
Multi-PIP Settings >	< Exit				
	PIP Mode >	PIP Off, PIP Child, PIP Split, PIP Wide.			
	PIP Display >	< Exit			
		PIP Child Size >		< Exit	
				PIP Size >	(Slider Bar 1~9)
				PIP H-Size >	(Slider Bar 0~20)
			PIP V-Size >	(Slider Bar 0~20)	
		PIP Position >		< Exit	
			PIP H-Position >	(Slider Bar 0~100)	
			PIP V-Position >	(Slider Bar 0~100)	
	Swap Source >	(Automatic Action)			
	PIP Picture >	< Exit			
		Brightness >		(Slider Bar 0~255)	
Contrast >			(Slider Bar 0~255)		
Saturation >			(Slider Bar 0~255)		
Hue >			(Slider Bar 0~255)		
	Sharpness >		(Slider Bar 0~24)		

OSD Menu Overview

OSD Settings

Level 1 (Main Menu)	Level 2	Level 3	Level 4	Level 5	
OSD Settings >	< Exit				
	OSD Position >	< Exit			
		OSD H. Position >	(Slider Bar 0~255)		
		OSD V. Position >	(Slider Bar 0~255)		
	Language >	< Exit			
		Norsk >	(Select for Norwegian)		
		English >	(Select for English)		
		Français >	(Select for French)		
		Deutsch >	(Select for German)		
		Italiano >	(Select for Italian)		
		日本語 >	(Select for Japanese)		
		簡體中文 >	(Select for Simplified Chinese)		
	Presets >	< Exit			
		Recall >	(Automatic Action) Performs Factory Defaults!		
		Save >	< Exit		
			User 1 to 5 >	(Automatic Action)	
		Load >	< Exit		
		User 1 to 5 >	(Automatic Action)		
	OSD Timeout (Sec) >	(Slider Bar 0~30)			
	OSD Transparent >	(Slider Bar 0~255)			
	OSD Mode >	< Exit			
		Basic >	(Select)		
		Advanced >	(Select)		
		Service >	(Select)		
	OSD Lock Mode >	Normal Mode >	(Select)		
		Menu Protect >	(Select) and Enter Key Code "321"		
		Full Protect >	(Select) and Enter Key Code "321"		
	Hot Key Assignment >	Key 1 >	OSD Language, Test Pattern, Swap Source, Graphic Scaling, PIP Mode, Second Source, Main Source, PIP Child Size, Black Level, No Function		
		Key 2 >	OSD Language, Test Pattern, Swap Source, Graphic Scaling, PIP Mode, Second Source, Main Source, PIP Child Size, Black Level, No Function		
	OSD Key Outdoor >	< Exit			
		On / Off			

OSD Menu Overview

Management Settings

Level 1 (Main Menu)	Level 2	Level 3	Level 4	Level 5	
Management Settings >	< Exit				
	* Graphic Scaling >	< Exit			
		Graphic Scaling >	Full Screen, Fill to Aspect Ratio, One To One		
		Zoom >	(Slider Bar 0~100)		
		Horizont Stretch >	(Slider Bar 0~100)		
		Vertical Stretch >	(Slider Bar 0~100)		
		Auto Adjustment >	On, Off		
		* Unknown Timing Search >	< Exit		
			Auto Mode >	< Exit	
				Display Size >	4:3, 5:4, 1:1, 16:9, 16:10
				Execute >	(Automatic Action)
			Blind Mode >	< Exit	
				H. Resolution >	(Slider Bar 0~2000)
				V. Resolution >	(Slider Bar 0~2000)
				Total H. Line >	(Slider Bar 0~2000)
				H. Blank Pixels >	(Slider Bar 0~500)
				V. Blank Pixels >	(Slider Bar 0~500)
				Execute >	(Automatic Action)
			Save Timing >	Save Timing 1 to 8 >	(Automatic Action)
			Clear Timing >	Clear Timing 1 to 8 >	(Automatic Action)
		* GDC Sensitivity >	(Slider Bar 0~255)		
		* Filter >	Enable, Disable		
		* Communication >	< Exit		
			RS232 >	(Select)	
			2-wire RS-485 >	(Select)	
			4-wire RS485/422 >	(Select)	
			Address RS >	(Slider Bar 0~15)	
			IP Address >	Auto IP >	(Select)
				Fixed IP >	(Number Input; xxx.xxx.xxx.xxx)
			Enable RS232 FW Download >	Enable, Disable	
		* Power Plan >	< Exit		
			VGA Out / USB in OFF Mode >	Enable, Disable	
			LAN in OFF / Sleep Mode >	Enable, Disable	
		* Touch Power Enabled >	< Exit		
			Always >	(Select)	
			Disp. on & Active Inp	(Select)	
			Disp. on & Active Sel Inp >	< Exit	
				Digital 1 >	(Select)
				Digital 2 >	(Select)
				Analog RGB 1 >	(Select)
			Composite 1 >	(Select)	
			Composite 2 >	(Select)	
			Composite 3 >	(Select)	
			DisplayPort 1 >	(Select)	
	* External Power Button >	Enable, Disable			
	* DDC/CI Setting >	Digital 1, Digital 2, Analog RGB1, DisplayPort 1, None			

OSD Menu Overview

Service Settings

Level 1 (Main Menu)	Level 2	Level 3	Level 4	Level 5	
Service Settings >	< Exit				
	Video Scaler Firmware Ver >	(Text Displayed)			
	uC Firmware >	(Text Displayed)			
	Elapsed Time >	(Text Displayed)			
	Current Temp >	(Text Displayed)			
	Fault Status >		(Text Displayed)		
			< Exit		
			NVRAM >	(Text Displayed)	
			Ethernet >	(Text Displayed)	
			GDC >	(Text Displayed)	
			TMP Sensor >	(Text Displayed)	
		Video Scaler >	(Text Displayed)		
	Test Pattern >		(Automatic Action)		
	Burn In >		Enable, Disable		
Smart ISP >		(Select)			
Watchdog Test >		(Select)			

OSD Menu Functions

On Screen Display (OSD) Menu Functions

The following section covers all possible settings that the user can (in a certain mode) encounter or needs to adjust via easy understandable menus, text and navigation. For simpler reading the menu choice **"Exit"** has been left out of description in this chapter intentionally. Whenever **"Exit"** is available, you can exit current menu and go back to the previous one visited. When there is no more previous menus available, the OSD menu overlay will be shut off and hidden. All settings are saved real-time or when you exit a menu (including time out of menu visibility).

The number shown in the "|-----x-----" line gives the indication of the submenu level where the function is located (also reference to the table in the previous chapter). It requires the user to touch the "MENU" symbol to enter that submenu.



Please note: Available functions described may deviate slightly from actual OSD menu on your unit. This is due to different OSD software configurations and customized solutions. Shown here are factory standards.

Input Source Settings

Lets you configure Main and Secondary signal source inputs (DVI, DisplayPort, VGA or Composite video signals) as well as activate or disable the Auto Source functionality. The contents of these submenus are listed below.

|---2--- Input Source Settings - Main Source

The possible signal inputs are; "Digital 1" (DVI), "Digital 2" (DVI), "Analog VGA1" (RGB/VGA), "Analog VGA2" (RGB/VGA), "Composite 1", "Composite 2", "Composite 3" (Composite Video) and DisplayPort 1 (DP). Composite Video inputs supports standard PAL/NTSC/SECAM signals.

- Note: The current active main source name will be greyed out in the list. By factory default, "Digital 1" (DVI) are assigned as Main Source. The current active main source will be shown in green color at the bottom of this menu.

|---2--- Input Source Settings - Second Source

The possible signal inputs are; "Digital 1" (DVI), "Digital 2" (DVI), "Analog VGA1" (RGB/VGA), "Analog VGA2" (RGB/VGA), "Composite 1", "Composite 2", "Composite 3" (Composite Video) and DisplayPort 1 (DP). Composite Video inputs supports standard PAL/NTSC/SECAM signals.

- Note: The current active secondary source name will be greyed out in the list. Also, if DVI, VGA or DP are defined as Main Source, they cannot be re-selected as second source as well. The second source is used together with Main Source for the Picture-in-Picture (PIP) functionality. PIP works only with one source of DVI/DP/VGA together with Composite Video sources. By Factory default "Composite 1 (Video)" are assigned as the second source. The current active main source will be shown in green color at the bottom of this menu.

OSD Menu Functions

Input Source Settings - DVI-I1 Mode

This OSD setting item is used to select the DVI-I1 port operating mode.

Settings as follows:

- DVI Mode = The port is locked to DVI-D mode, only accepting digital input. "Analog RGB1" option in input source selection will be disabled.
- VGA Mode = The port is locked to VGA mode, only accepting analog input. "Digital 1" option in input source selection will be disabled.
- Auto Mode = The port can work in both DVI-D and VGA mode.

Note: For graphic cards which comes with DVI-I output, it is suggest to lock the operating mode to DVI mode or VGA mode.

- Note: By factory default, this setting is configured as "Auto Mode".

Input Source Settings - DVI-I2 Mode

This OSD setting item is used to select the DVI-I2 port operating mode.

Settings as follows:

- DVI Mode = The port is locked to DVI-D mode, only accepting digital input. "Analog RGB 2" option in input source selection will be disabled.
- VGA Mode = The port is locked to VGA mode, only accepting analog input. "Digital 2" option in input source selection will be disabled.
- Auto Mode = The port can work in both DVI-D and VGA mode.

Note: For graphic cards which comes with DVI-I output, it is suggest to lock the operating mode to DVI mode or VGA mode.

- Note: By factory default, this setting is configured as "Auto Mode".

Input Source Settings - Auto Source Select

Set to either 'Enable' or 'Disable'. Signal is automatically searched for and selected. If the Main Source signal is disconnected physically, the video controller will automatically search and select from the next item available in the list, such as; "Digital 1" (DVI), "Digital 2" (DVI), "Analog VGA1" (RGB/VGA), "Analog VGA2" (RGB/VGA), "Composite 1", "Composite 2", "Composite 3" (Composite Video) and "DisplayPort 1" (DP).

- Note: If all signals was physically disconnected from the unit, the Auto Source function will loop endlessly until it detects a valid signal to display. By factory default, this setting is configured as "Enable".

OSD Menu Functions

Input Source Settings - Rename Source

By factory default, every signal source input are named based on it's signal property as described in the previous functions, but with the rename source function you can rename these into more understandable descriptions like; "FRONT-CAMERA", "NIGHT RADAR" etc. When activated, a requester on screen similar to a standard keyboard layout will appear. Use the "(-) Brilliance (+)", "(<) Navigation (>)" and "MENU" touch buttons to enter and edit the new name. Below is an example for editing the "Source" input name. Only uppercased letters allowed.

The "|<" button will erase (backspace) the last character entered. Press "Enter" to save new name.

Yellow border around letter indicate selected character.



OSD Menu Functions

Image Settings

Lets you configure various visual preferences for any signal. The contents of these submenu are listed below.

Image Settings - Auto Position

Will automatically fit the current displayed full screen signal and center it based on the active area of the TFT display. This function rely on properties of the incoming signal.

- Note: This function will not try to scale or deform the image, so if the image looks stretched, please review the Management Setting/Scaling function later in this manual to adjust it on pixel level. Available for RGB/VGA mode only.

Image Settings - Auto Color Balance

Choose between "Yes" or "No". This function will automatically adjust the color balance of the current displayed full screen signal. This function will analyse the incoming signal strength for RGB values and adjust it for "best eye visuality". Colors are automatically calculated based on a overall coloring model to attempt a more true, relevant and correct look. In general, you should display a image on screen while performing this action that contains variations of Red, Green, Blue, Black, White, Gray colors to get the best optimal balance of the current signal. An example is a test pattern image, similar to the picture illustrated later in the manual (see "Service - Test Pattern")

- Note: Available for RGB/VGA mode only.

Image Settings - Brightness

***Available in "Advanced" only**

Increase/decrease the black level saturation in real-time of the current displayed full screen signal. Window overlays (PIP/PBP) and the OSD Menu overlay will be unaffected. A visual slider in the OSD menu will show the current value. This value adjusts the TFT panel's brightness by controlling the voltage feed.

- Note: Value adjustable from 0 to 255. 128 is factory default.

Image Settings - Contrast

***Available in "Advanced" only**

Increase/decrease the contrast in real-time of the current displayed full screen signal. Window overlays (PIP/PBP) and the OSD Menu overlay will be unaffected.

- Note: Value adjustable from 0 to 255. 128 is factory default.

Image Settings - Saturation

***Available in "Advanced" only + Video Fullscreen**

Increase/decrease the overall video color saturation/color amount of the current displayed full screen image (no effect on DVI/DP/VGA signals). Can be used if the incoming CVBS signal from older equipment (due to bad cables) appear to have a lack of strong colors or just to generally make the displayed image become more vivid. Note that this function can also make noisy color signals appear crisper/clearer if adjusted to gray scales.

- Note: Value adjustable from 0 to 255. 128 is factory default.

OSD Menu Functions

Image Settings - Hue

***Available in "Advanced" only + Video Fullscreen**

Allows to adjust/shift the main color properties of all Red, Green, Blue and Yellow (unique hues) values. This can be useful for certain Composite Video sources (no effect on DVI/DP/VGA signals) whose output may have shifted or seems to be "out of phase", where for instance blue seems more dominant than green, red and yellow-ish colors. By using HUE one can shift the entire color range of all components left or right in the spectrum.

- Note: Value adjustable from 0 to 255. 128 is factory default.

Image Settings - Sharpness

Increase/decrease the overall image sharpness. This affects the active display area, and applies to all signal inputs and window overlays (PIP/PBP). Use it to increase the visual quality of signals from possible older equipment or improve electronically weak signals.

- Note: Value adjustable from 0 to 24. 12 is factory default. Available in RGB/VGA, CVBS modes only.

Image Settings - Display

Allows to adjust DVI/DP/VGA signals Horizontally (left/right) and Vertically (up/down) within the TFT panel Active Area. If the incoming signal is "Analog VGA" (RGB/VGA) only, Clock and Phase can also be adjusted (if there seems to be a "waterfall / rolling bars" effect present in the active display area).

- Note: This function can move information in the image outside the visible TFT Active Area, so use caution when modifying this parameter. Try to determine the max end of borders (look at each corner) of the image before you proceed using this function.

Image Settings - Display - H Position

Settings as follows:

"H Position" = Move image within the TFT panel active area Horizontally (left/right), values from 0 to 100.

- Note: Factory Default value (50) is centered inside the active TFT panel area.

Image Settings - Display - V Position

Settings as follows:

"V.Position" = Move image within the TFT panel active area Vertically (up/down), values from 0 to 100.

- Note: Factory Default value (50) is centered inside the active TFT panel area.

Image Settings - Display - Clock

Adjust the horizontal frequency (clock) of the analog signal to improve visibility of the entire image. When it is adjusted, you will notice that the image will appear to be stretched and might in some situations start to flicker/scroll, at which point you must reverse the last adjustment to stop it from flickering/scrolling anymore. This function can be used for older signals that is not automatically detected by the internal display controller.

To adjust the Clock and Phase to a optimal setting it is recommended to display a image with alternating white and black lines by stepped by 1 pixels either vertically or horizontally. It is suggested to use a dedicated and external test pattern while adjusting. Values from 0 to 100.

- Note: Available for RGB/VGA mode only.

Image Settings - Display - Phase

Fine tune the data sampling position of the signal (impacts on image quality). This function will remove small transparent defects in typical characters where a portion seems to be more faint then the nearby black pixels. The faint pixels are always visible as a line from top to bottom (vertically). Note that this function is automatic and does not allow for manual values. It is suggested to use a dedicated and external test pattern while adjusting. Values from 0 to 100.

- Note: Available for RGB/VGA mode only.

Image Settings - Display - Picture Direction

Choose between "0" and "180" degree rotation. 0 is normal view (Landscape), while 180 will rotate image on screen to Portrait Mode. Factory default setting is "0" (Landscape).

OSD Menu Functions

Image Settings - Video Setup

***Available when Video Fullscreen only**

Provides submenus where the following settings for Composite video signals are available:

Image Settings - Video Setup - Main MADI mode

Motion Adaptive De-Interlacing. Motion adaptive de-interlacing is a pixel-based two-phase process. Phase 1 involves the detection of motion and the generation of a motion value for each pixel. These pixel motion values are used as a measure of the current "degree of motion". In Phase 2, the pixel motion values are used to select the appropriate de-interlacing technique. As a result, areas of an image that are not moving will be fully static (flicker free) and moving objects will have smooth edges.

Set to either "Normal", "Adaptive" or "OFF".

- Note: Default is OFF

Image Settings - Video Setup - Noise Reduction

The media noise reduction block removes unwanted ringing and block noise from images that have undergone MPEG or JPEG compression and decompression. The two types of media noise that can be reduced are:

- Block Noise: MPEG encoders, in the presence of an almost flat area, can create a squared structure due to the discrete 8x8 squares that are used in the MPEG compression process. This creates a noticeable squared structure in the image. The process smoothens these square boundaries so they are not visible. The amount of smoothing is programmable between neighboring pixel values that will be smoothed. The amount of smoothing starts to decrease linearly from the maximum (defined by TO) to 0 (defined by 2 x TO) to avoid the hard switch effect of the smoothing applied.
- Mosquito Noise: This process smoothens checker box and discrete noise artifacts referred to as Mosquito Noise around large edge transitions caused by MPEG encoders.

This submenu will give you the following choices:

Image Settings - Video Setup - Noise Reduction - Dynamic NR Mode

Dynamic NR (Noise Reduction) Mode can be set to either "High", "Medium", "Low", "Adaptive" or "OFF". This is the "strength" of how much noise to detect and automatically remove in order to enhance the overall image quality. The Block Noise process will be used.

- Note: Default is OFF

OSD Menu Functions

4 Image Settings - Video Setup - Noise Reduction - MPEG NR Mode

MPEG NR (the generic coding of moving pictures and associated audio information) can be set to either "ON" or "OFF". This function will try to reduce noise as result from compressed/formatted MPEG video streams. This noise is often seen as larger blocks or containers of compressed pixels and is suitable to improve the visual performance of video feeds capable of outputting direct MPEG streams. The Block Noise process will be used.

- Note: Default is OFF

4 Image Settings - Video Setup - Noise Reduction - Sharpness Noise Coring

Adjust the clarity after Noise Reduction was applied to the video signal. Can be set to "High", "Medium", "Low", "Adaptive" or "OFF". The Mosquito Noise will be used.

- Note: Default is OFF

3 Image Settings - Video Setup - Film Mode

This function will analyze the resolution and frames per second information in the video feed and determine how to process/display each frame correctly (to avoid judder and staggering playback), also referenced as "pull down method". This option should be chosen to secure that the video feed is at maximum quality and performance. 2:2 is suitable for PAL/SECAM signals, while 2:3 is suitable for NTSC signals. 2:2-2:3 will try to conform to both standards and may be suited in some cases for mixed incoming video feeds. 3:2 film enables sequences of 24 Hz original film content and convert this to an output of 48 Hz or 72 Hz vertical refresh rate. This feature reduces the noticeable uneven judder seen on a 3:2 film sequence that is converted to 60 Hz vertical refresh rate.

Set to either; "2:2", "3:2", "3:2-2:2" or "OFF".

- Note: Default is OFF

3 Image Settings - Video Setup - DCDi

DCDi® BY Faroudja low-angle Diagonal interpolation. In addition to the advanced de-interlacing capabilities mentioned in the previous sections, further image enhancement is achieved by applying special processing to a moving lowangle diagonal pattern in a video image. For motion video, the intra-field interpolation is done using the patented and highly acclaimed DCDi® (Directional Correlational De-Interlacing) algorithm by Faroudja®. Conventional Interpolation algorithms operate on the basis that the current pixel is related to the pixels above and below it. This is untrue of diagonal edges. Whenever an edge is not vertical, the way the current pixel depends on the angle of the edge is related to those diagonally above and below it. Hence, conventional vertical Interpolation algorithms work well on edges close to the horizontal and vertical directions. However, they will break down completely as the angles of edges become more diagonal, causing jagged edge artifacts. DCDi® by Faroudja computes and tracks the angles of edges and uses this information to optimally fill in the missing pixels, removing jagged edge artifacts.

Set to either "ON" or "OFF".

- Note: Default is OFF

OSD Menu Functions

Color Mode Settings

Lets you adjust the color temperature (Kelvin degrees) of the image. This applies to the Main Source signal. Window overlays (PIP/PBP) and the OSD Menu overlay will be unaffected. Lower values make the image appear warmer, while higher values will make it appear cooler. The contents of these submenus are listed below.

Illustration (does not appear in menu): The Kelvin color temperature scale (approximate and symbolic):

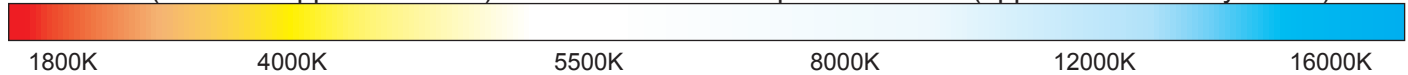

|---2--- Color Mode Settings - Color Temperature

Set to either "9300K" (Cool, a blueish white), "8000K" (Neutral, a white close to natural light), "6500K" (Warm, a reddish white) or "User", (only available when Full Menu is active).

|-----3----- Color Mode Settings - Color Temperature - User

Allows individual adjustment of Red, Green and Blue color gains. The selected setting will be preserved for each signal input respectively.

- Note: Value adjustable from 0 to 255. 128 is factory default.

|---2--- Color Mode Settings - Gamma

***Available in "Advanced" only + Video Fullscreen**

This will activate the stored gamma curve color compensation as well as the LED indicators or backlight brilliance used with ECDIS. Set to either "No Calibration", "Calibration VGA", "Calibration DVI" or "Calibration DisplayPort", where these represents the two storage locations for compensation data. When either of them are active, they will override the color temperature setting for the signal channel. Different signal channels can be set to different settings that will be preserved.

This function is suitable for use with external equipment. Color temperature will be disabled.

- Note: Default is "No Calibration" with Gamma 2.2 and 140nits.

OSD Menu Functions

Multi-PIP Settings

Lets you adjust how the Picture-in-Picture (PIP) or Picture-by-Picture (PBP) display modes is set up. The default position of the rectangle is set to upper left corner of the Active Display area. Note that this requires a valid incoming signal to be present in any of the "DVI", "DisplayPort", "VGA" or "Composite" inputs. The contents of these submenus are listed below.

Multi-PIP Settings - PIP Mode

Settings as follows:

"PIP OFF" = Function is inactive and other settings can not be accessed.

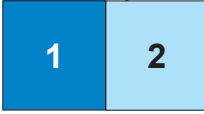
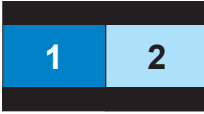
 <p>"PIP Child"</p>	The Secondary Source will be displayed in a small frame as an overlay over the Main Source signal. When this function is activated a new menu item will appear under "PIP Mode" called "PIP Display". Known as "Picture-In-Picture (PIP)".
 <p>"PIP Split"</p>	The Main Source and Secondary signal sources are shown side-by-side with the Main Source to the left and the Secondary Source to the right. Note that only 50% of each source is actually visible on screen (split in two). When this function is activated a new menu item will appear under "PIP Mode" called "PIP Display". Known as "Picture-By-Picture (PBP)".
 <p>"PIP Wide"</p>	The Main Source and Secondary signal sources are shown side-by-side in widescreen mode with the Main Source to the left and the Secondary to the right. When this function is activated a new menu item will appear under "PIP Mode" called "PIP Display". Known as "Picture-By-Picture (PBP)".

- Note: Default is OFF

Multi-PIP Settings - PIP Display

***Available only when PIP Mode on**

When PIP Child mode is active, the size and position of the rectangle displaying the Secondary Source can be adjusted via the submenus below. Secondary Source needs to be a valid signal source.

Multi-PIP Settings - PIP Display -- PIP Child Size

Settings as follows:

"PIP Size" = Adjust the full size (H and V) for Secondary Source, values from 1 to 9. Factory Default is 9.

"PIP H-Size" = Adjust the Horizontal size for Secondary Source, values from 0 to 20. Factory Default is 10.

"PIP V-Size" = Adjust the Vertical size for Secondary Source, values from 0 to 20. Factory Default is 10.

- Note: Default value for all 3 functions is 0.

Multi-PIP Settings - PIP Position

When PIP Child mode is active, the size and position of the frame displaying the Secondary Source can be adjusted by means of submenus for size and position respectively below.

Settings as follows:

- | | |
|------------------|--|
| "PIP H-Position" | = Adjust the Horizontal (left/right) position for Secondary Source, values from 0 to 100. Factory Default is 50. |
| "PIP V-Position" | = Adjust the Vertical (up/down) position for Secondary Source, values from 0 to 100. Factory Default is 50. |

Multi-PIP Settings - Swap Source

Swaps the Main and Secondary source signals (if present) including adjustments you may have made, meaning that whatever is in Main Source will become the contents of the defined PIP rectangle, and contents of the PIP rectangle to become full screen.

- Note: You can also assign the Swap Source to the Hotkeys. Review "OSD Settings - Hot Key Assignment / Swap Source" section later in this manual.

Multi-PIP Settings - PIP Picture

When PIP mode is active, the picture appearance of the Secondary Source can be adjusted via the following settings:

Settings as follows:

- | | |
|--------------|--|
| "Brightness" | = Adjust the black level (brightness) of the Secondary Source, values from 0 to 255. Factory Default is 128. |
| "Contrast" | = Adjust the contrast of the Secondary Source, values from 0 to 255. Factory Default is 128. |
| "Saturation" | = Adjust the overall color intensity of the Secondary Source, values from 0 to 255. Factory Default is 128. |
| "Hue" | = Adjust the Hue color properties of the Secondary Source, values from 0 to 255. Factory Default is 128. |
| "Sharpness" | = Adjust the sharpness of the Secondary Source, values from 0 to 24. Factory Default is 12. |

OSD Menu Functions

OSD Settings

Allows you to customize the visual appearance of the On Screen Display (OSD) menu, such as; position, transparency, time-out, assign hot keys, define access modes and save, load and recall favourite settings and more. The contents of these submenus are listed below.

OSD Settings - OSD Position

Settings as follows:

"OSD H. Position" = Place the OSD menu overlay Horizontally (left/right), values from 0 to 255.

"OSD V. Position" = Place the OSD menu overlay Vertically (up/down), values from 0 to 255.

- Note: Default position of the OSD menu overlay is in the lower left corner of the of the Active Display area. Default value for both functions is 255.

OSD Settings - Language

Available OSD language to be used for all text and warnings that may appear.

Settings as follows:

"Norsk" = Display OSD in Norwegian.

"English" = Display OSD in English.

"Français" = Display OSD in French.

"Deutsch" = Display OSD in German.

"Italiano" = Display OSD in Italian.

"日本語" = Display OSD in Japanese.

"簡體中文" = Display OSD in Simplified Chinese.

- Note: Current selected language is shown in green color. Default language is English.

OSD Settings - Presets

Allow to work with Memory Presets (Recall/Save/Load) for OSD menu settings and overlays. The contents of the submenu is listed below.

Settings as follows:

"Recall" = Reset back to factory defaults. Will override and restore all previous modified settings.

OSD Menu Functions

OSD Settings - Preset Save - Save

Allows to save current state of all function and values to user defined presets. The contents of the submenu is listed below.

Settings as follows:

"User 1"	= Save all OSD settings to User 1 slot.
"User 2"	= Save all OSD settings to User 2 slot.
"User 3"	= Save all OSD settings to User 3 slot.
"User 4"	= Save all OSD settings to User 4 slot.
"User 5"	= Save all OSD settings to User 5 slot.

OSD Settings - Preset Save - Load

Allows to load current state of all function and values to user defined presets. The contents of the submenu is listed below.

Settings as follows:

"User 1"	= Load all OSD settings from User 1 slot.
"User 2"	= Load all OSD settings from User 2 slot.
"User 3"	= Load all OSD settings from User 3 slot.
"User 4"	= Load all OSD settings from User 4 slot.
"User 5"	= Load all OSD settings from User 5 slot.

OSD Settings - OSD Timeout (Sec)

Adjust the timeout in seconds that the OSD menu overlay is automatically exited and hidden from view including locking mode (see OSD Lock Mode/Advanced Mode on next page). This timeout is counted from last activity (navigation or adjusting parameters). The value is adjustable from 0 to 30 seconds.

- Note: Default timeout value is 10 seconds.

OSD Settings - OSD Transparent

Adjust the alpha blend also known as transparency of the OSD Menu overlay. It means that all signal inputs and PIP/PBP images show through the OSD Menu. It is used when important information on the display is necessary to be visible at all times.

- Note: Level adjustable from 0 to 255. 0 is factory default (no transparency/solid background color).

OSD Settings - OSD Mode

Configuring the OSD Menu access based on most common functions to service/troubleshooting.

Settings as follows:

- "Basic" = A few functions is not visible/available in this state. For most uses this is the preferred setting and are safe for the display functionality and continuous trusted operation on the unit.
- "Advanced" = All functions and parameters is visible/available in this state. Some of the settings adjusted could impact on display functionality and image quality. Only experienced and qualified personnel should access and change parameters when in this mode. Also, more technical details about signals, frequency will be available.
- "Service" = Only applicable for authorized service personnell. Key code is available from Hatteland Display service network / HelpDesk.

- Note: Learn how to navigate and enter the correct code, by reading the "OSD Keycode / OSD Lock Mode" introduction section in the previous chapter.
- Note: When requesting "Advanced" mode from "Basic" mode, the user are required to enter a key code. This code is factory preset to "362". You can enter the code by using navigation and "MENU" to confirm. After a successful entering of the key code, the OSD menu will always be in this state during powered on. After a power off and on to the unit, the OSD Mode will be reverted back to "Basic" mode.

OSD Settings - OSD Lock Mode

To prevent accidental or unwanted user intervention, you can set the behaviour of how the OSD menu is accessible by the user including adjusting brightness via the "(-) Brilliance (+)" symbols. Normally by factory default accessible by touching the "MENU" symbol on the front glass of the unit.

Settings as follows:

- "Normal Mode" = Default accessible pop-up by touching the "MENU" symbol. For Non-ECDIS Compliant usage.
- "Menu Protect" = Ask for key code first (321) when the "MENU" symbol is touched on the front glass and before the OSD menu will appear. Required for ECDIS Compliance usage.
- "Full Protect" = When activated: You will have to touch the "MENU" symbol for 5 seconds after which the key code requester will appear. Note that only the "MENU" symbol will activate the password request, all other touches on other symbols are ignored. After key code was entered and accepted, the OSD menu will appear in which case you have "x" seconds to use brilliance and power functions before all functions are deactivated again and returns to "Advanced Mode".

"x" value is defined as OSD Timeout value (see previous page).

- Note: Learn how to navigate and enter the correct code, by reading the "OSD Keycode / OSD Lock Mode" introduction section earlier in this chapter.

OSD Settings - Hot Key Assignment

Assign a commonly used OSD menu function to the available touch enabled Hot Keys which is located on the front display glass. The following functions are available to assign and most of them have a negative and positive counting logic. All of these functions are described before and after this segment in the manual.

Settings as follows (for both "Key 1" and "Key 2"):

"OSD Language"	= Flip up/down through available languages (real-time changes).
"Test Pattern"	= Display the internal test image overriding any signal inputs. Both Hot Keys performs the same action.
"Swap Source"	= Swap the Main Source and Secondary Source appearance. Both Hot Keys performs the same action.
"Graphic Scaling"	= Flip up/down through the scaling methods available.
"PIP Mode"	= Flip up/down through the PIP/PBP functions. Note: Only when PIP is active. Does not work for Fullscreen.
"Second Source"	= Flip up/down through the available signal sources (to PIP/PBP).
"Main Source"	= Flip up/down through the available signal sources (to full screen).
"PIP Child Size"	= Increase/Decrease the size of the Picture-In-Picture overlay.
"Black Level"	= Increase/Decrease Brightness of the TFT panel (not backlight).
"No Function"	= Nothing will be activated when user touches Hot Keys on front glass. Both Hot Keys performs the same action.

- Note: Default Hot Keys are assigned to "No Function". You can assign different functions to "Key 1" and "Key 2".

OSD Settings - OSD Key Outdoor

To prevent accidental activation of Glass Display Control™ (GDC) touch functions, you can add an extra layer of security on how "sensitive" the touch detection operates. This applies for "MENU", "(-) Brilliance (+)" and "Power Off" functions. The OSD Key Outdoor function is especially effective if the unit is located in a outside environment where rain drops could potentially trigger touch button functions. Note that this setting does not apply for fullscreen sized touch screen glasses.

Settings as follows:

"Off"	= All touch symbols operates normally. Factory Default setting.
"On"	= Touch symbols responds when you press and hold it for 5 seconds.

OSD Menu Functions

Management Settings

Allows you to adjust overall settings for interaction/communication for the unit, such as scaling, zoom, timing of signals, sensitivity for the touch control, VGA filter and Serial/Ethernet communication and more. The contents of these submenus are listed below.

|---2--- Management Settings - Graphic Scaling *Available in "Advanced" only

Allow to scale the currently displayed full screen signal in various ways. The contents of the submenus is listed below.

|-----3----- Management Settings - Graphic Scaling - Graphic Scaling

All scaling will performed from center of active display area and outwards in all directions.

Settings as follows:

- | | |
|------------------------|--|
| "Full Screen" | = Zoom current full screen signal to fill the entire active display area. Aspect ratio is ignored, which means that picture may appear distorted or stretched. |
| "Fill to Aspect Ratio" | = Zoom current full screen signal to fill the entire active display area and preserve the aspect ratio. This means that you may notice black bars without any image information either on top/bottom or left/right of the centered image. |
| "One To One" | = Zoom current full screen signal to fill the entire active display area as 1:1 native pixel resolution. Example; if the incoming signal is a 800x600, on a 1600x1200 unit, the incoming signal will be shown 50% less in size and centered on screen. Aspect ratio is kept unchanged. |

|-----3----- Management Settings - Scaling - Zoom

All zooming will performed from center of active display area and outwards in all directions.

Settings as follows:

- | | |
|--------|---|
| "Zoom" | = Zoom the current full screen signal horizontally and vertically in equal steps. Values from 0 to 100. |
|--------|---|

- Note: Values under or over 50, may cause blurry and unfocused imagery, since it overrides the external signal's 1.1 pixel information and properties. Factory Default value is 50.

OSD Menu Functions

Management Settings - Graphic Scaling - Horizont Stretch

All stretching will performed from center of active display area and outwards in one direction.

Settings as follows:

"Horizont Stretch" = Zoom/stretch current full screen signal in Horizontal direction only (left and right). Values from 0 to 100.

- Note: Values under or over 50, may cause blurry and unfocused imagery, since it overrides the external signal's 1.1 pixel information and properties. Factory Default value is 50.

Management Settings - Graphic Scaling - Vertical Stretch

All stretch will performed from center of active display area and outwards in one direction.

Settings as follows:

"Vertical Stretch" = Zoom/stretch current full screen signal in Vertical direction only (up and down). Values from 0 to 100.

- Note: Values under or over 50, may cause blurry and unfocused imagery, since it overrides the external signal's 1.1 pixel information and properties. Default value is 50.

Management Settings - Auto Adjustment

Allow to let the video controller always perform a Automatic Adjustment based on the detected properties in the incoming signal or when incoming signal sources changes it's properties real time. It will scale and position incoming signal sources that has changed since the last detection was executed successfully. Set to either "ON" or "OFF".

- Note: This function is the same as the manual function found in "Image Settings - Auto Position" earlier described. Default value is "OFF".

OSD Menu Functions

Management Settings - Unknown Timing Search

***Available in "Advanced" only**

Use this if you are unable to find or detect the incoming full screen signal automatically (applies for Analog VGA and CVBS video signals only. A PIP or PBP configured signal is not supported). It may be a customized signal regarding resolution and refresh frequency. In these situations the custom signal sources can be searched upon or entered manually within the OSD menu and even stored conveniently. The contents of these submenus are listed below.

Management Settings - Unknown Timing Search - Auto Mode

Try to determine the incoming signal by automatic detection routines which is based on a known list of properties for resolutions and frequency combinations that fall out, but between the most common industry standard set of resolutions/refresh frequencies.

Settings as follows:

- | | |
|----------------|--|
| "Display Size" | = Force the Aspect Ratio to either to 4:3, 5:4, 1:1, 16:9 or 16:10 |
| "Execute" | = Choose to produce timing table, update the "Blind Mode Data" and refresh the screen condition using the data of the timing table. If this procedure seem to fail, use the "Blind Mode" below to enter values manually. |

Management Settings - Unknown Timing Search - Blind Mode

If you know the advanced properties of the incoming signal or want to troubleshoot a possible detected signal (that seem to have small deviations), you may try to adjust the values below and see the result in real time. These settings should be performed by a skilled technician or a individual that has the needed knowledge to do so. Internally these settings below are saved into a data register called "Timing Table".

Settings as follows:

- | | |
|-------------------|---|
| "H. Resolution" | = Set the Horizontal resolution of the timing table.
Values from 0 to 2000. |
| "V. Resolution" | = Set the Vertical resolution of the timing table.
Values from 0 to 2000. |
| "Total H. Line" | = Set the Total Horizontal Lines of the timing table.
Values from 0 to 2000. |
| "H. Blank Pixels" | = Set the Horizontal Start of timing table,
(sync pulse + back porch). Values from 0 to 500. |
| "V. Blank Pixels" | = Set the Vertical Start of timing table,
(sync pulse + back porch). Values from 0 to 500. |
| "Execute" | = Choose to produce timing table and refresh the screen condition using the data of the timing table. |

- Note: You may experience fast, slow flickering or sliding lines during adjustments. This is normal, and gives the indication that a different setting may have to be adjusted also, since all these functions are connected to each other in order to create a stable signal that the video controller can display correctly.

OSD Menu Functions

Management Settings - Unknown Timing Search - Save Timing

The current "Timing Table Data" that is currently visible in the "Blind Mode" or via the "Auto Mode" functions may now be saved to a user defined slot. Available save slots from 1 to 8. Saving "Time Table Data" may prove to be useful until the external equipment is either replaced or changed. If so, you should use the "Clear Timing" function below to remove any obsoleted "Timing Table Data" from time to time. Factory Default save slot is 1.

Management Settings - Unknown Timing Search - Clear Timing

Will allow to clear "Timing Table Data" currently saved / or not saved, based on the "Save Timing" function above. You may clear save slots 1 to 8. Factory Default slot is 1.

Management Settings - GDC Sensitivity

***Available in "Advanced" only**

The touch enabled symbols known as GDC (Glass Display Control™) available on the front glass of the unit can be adjusted in sensitivity. It basically means that a small value requires a larger area to be covered longer over time, while a large value will require less smaller area to be covered in less time. If you set the value too low or too high, you may feel a difference in either increased responsiveness or the lack of such. By factory default the value is set to 150.

Settings as follows:

"GDC Sensitivity" = Adjust values from 0 to 255.

- Note: Default is model dependent and set by factory. Note that the difference between 0 and 100 is minimal, as it is not suitable to go beyond a fair responsiveness that could cause accidental triggering of functions to occur by nearby objects touching the glass (i.e. rain drops for instance, washing glass with cloth).
- Caution: If the sensitivity value was set very low, you may experience an increased occurrence of non-responsiveness which also affects accessing the correct menu function in order to re-adjust this value. It is therefore suggested as a last resort solution to reset this value via SCOM (Serial/Ethernet Communication) functionality instead by sending a "Reset Factory Default" (or "Load User Default"+Slot Number, if available and previously stored by using "Save User Default"+Slot Number) commands if you are unable to navigate the OSD menu.

Please review the appropriate Technical User Manual located here:
<http://www.hatteland-display.com/pdflink/inb100018-6.php>

Management Settings - Filter

***Available in "Advanced" only**

Filter (applies for VGA1 signal input only) is a Signal Noise Reduction technique to enhance a possible weak or bad RGB/VGA signal. It will remove certain types of noise patterns typically apparent in close proximity of other electronic equipment with less or lack of proper shielding to prevent interference.

Settings as follows:

"Filter" = Set to either "Enable" or "Disable".

- Note: Default is "Disable"

The unit allows for remote control (adjust brightness for example) and/or accessing internal information about the unit such as typenumber, serial number and more. To setup this feature, you first need to configure the Serial or Ethernet protocol properly to match your external equipment specifications. The contents of the submenus is listed below.

Settings as follows:

- "RS232" = Sets the internal communication to standard RS-232 protocol.
- "2-wire RS-485" = Sets the internal communication to RS-485 protocol (Half duplex).
- "4-wire RS485/422" = Sets the internal communication to RS-485/422 protocol (Full duplex).
- "Address RS" = Set the global unique channel/port ID for the unit, 16 ID's available.
- "IP Address" = IP can be found Automatically or you can set the IP address manually (xxx.xxx.xxx.xxx) for Ethernet protocol by choosing "Fixed IP".
- "Enable RS232 FW"
"Download" = Allows Factory Firmware upgrade for the unit via RS-232 Serial Communication.

- Note: Default mode is "RS232" protocol.

A more detailed description of the SCOM (Serial/Ethernet Communication) can be found here:

<http://www.hatteland-display.com/pdflink/inb100018-6.php>

Review also the "Pinout Assignments" chapter in this manual for additional help during preparation and/or installation of external equipment intended to communicate with.

OSD Menu Functions

Management Settings - Power Plan

***Available in "Advanced" only**

This setting will allow to control the power mode of USB/VGA out and Ethernet port in Power off mode.

Settings as follows for "VGA Out/USB in Off Mode":

"Enable" = Enabled in power off mode.
"Disable" = Disabled in power off mode.

- Note: Factory Default set to "Disable"

Settings as follows for "LAN in OFF/Sleep Mode":

"Enable" = Enabled in power off mode.
"Disable" = Disabled in power off mode.

- Note: Factory Default set to "Enable"

Management Settings - Touch Power Enabled

***Available in "Advanced" only**

This setting will allow to filter the signal processing from touch screen to reach the computer. For instance, if user only want touch screen to be active when DisplayPort signal is defined as Main Input, but disallow touch screen processing on other signal inputs, the non-touch screen enabled signal inputs would require the user to operate elements on screen either with keyboard, mouse or just for information purposes only with no user interaction possible via touch screen.

Settings as follows:

"Always Active" = Touch is always enabled, even if there is no image on screen. Display unit may be powered off, but require power cable connected as well as a powered on computer. Signals from touch screen will still reach the computer.

"Any signal is On" = Touch is enabled when any input is active as Main Input.

"Select signal is On" = Following list and Choices available:

"Digital 1" = Touch is enabled only when DVI 1 is active as Main Input.
"Digital 2" = Touch is enabled only when DVI 2 is active as Main Input.
"Analog RGB 1" = Touch is enabled only when VGA is active as Main Input.
"Analog RGB 2" = Touch is enabled only when VGA is active as Main Input.
"Composite 1" = Touch is enabled only when Composite 1 is active as Main Input.
"Composite 2" = Touch is enabled only when Composite 2 is active as Main Input.
"Composite 3" = Touch is enabled only when Composite 3 is active as Main Input.
"DisplayPort" = Touch is enabled only when DisplayPort is active as Main Input.

OSD Menu Functions

|---2--- Management Settings - External Power Button *Available in "Advanced" only

This setting will allow to manually enable the use of an external power button to turn off the Display unit. Please review the Pinout Assignments (Potmeter Control 9-pin DSUB MALE Connector) for connectivity.

Settings as follows:

- | | |
|-----------|--|
| "Enable" | = Key press from External power button detection enabled. |
| "Disable" | = Key press from External power button detection disabled. |

- Note: Factory Default set to "Disable"

|---2--- Management Settings - DDC/CI Setting *Available in "Advanced" only

This setting will allow user to enable and set which signal input where DDC/CI display control communication will occur. For more information about DDC/CI, please review the "Operation Advanced (DDC/CI) Control Overview" chapter in this manual.

The possible choices are: "Digital 1" (DVI), "Digital 2" (DVI), "Analog RGB 1" (VGA), "Analog RGB 2" (VGA), "DisplayPort 1" (DP) and "None".

- Note: Factory Default set to "None"

OSD Menu Functions

Service Settings

Will show various technical and unit related information, such as; Firmware versions, Elapsed Time, Internal Temperature, Fault Status and activation for the internal Test Pattern image useful for trouble-shooting. Some of these functions are static information while others are accessible. Whenever you are in contact with helpdesk or service personnel, they might require you to read back some of these values in order to precisely pinpoint any problem/question you should have with the unit or its functionality.

Information blocks as follows:

"Video Scaler Firmware"	= Displays the firmware version of the internal videocontroller. Example: "FW200001-0BV2"
"uC Firmware"	= Displays the firmware version of the touch enabled buttons. Example: "FW100002-0A12"
"Elapsed Time"	= Shows the time elapsed in hours since first-time power on. Example: "180"
"Current Temp"	= Shows the internal temperature measured by onchip sensor. Example: "+027.0 C", in Celcius Degrees.
"Fault Status"	= Will show detected Fault Status by measuring various internal values. Status is stated as either "OK" or "FAULT"

Service - Fault Status

Will show detected Fault Status by measuring various internal values during operation. Status is stated as either "OK" or "FAULT". The contents of this submenu is listed below.

Fault Status as follows:

"NVRAM"	= Status for Non-volatile random-access memory, used to store parameters and settings.
"Ethernet"	= Status for Ethernet/LAN communication chip controller.
"GDC"	= Status for Glass Display Control™ (GDC) touch button controller.
"TMP Sensor"	= Status for internal temperature measured by on-chip sensor.
"Video Scaler"	= Status for on-board Digital Visual Interface graphics chip processor.

OSD Menu Functions

Service Settings - Test Pattern

Will show the internal test pattern with greyscales, colors and raster patterned boxes to check for deviations in the TFT panel/display controller behaviour. It is independent of any current resolution or specifications found in the signal inputs. The test pattern is generated internally in the display controller and is sent 1:1 directly to the TFT panel. It can be useful during trouble-shooting situations to determine the source of a display or connectivity problem regarding external equipment.

To active this function, touch the "MENU" button.

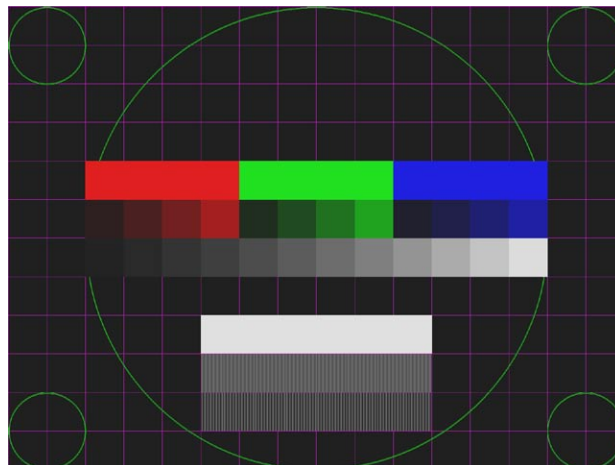

- Note: This function will not inform/report any deviations directly, you need to have the required technical expertise to interpret the test pattern displayed.

Service Settings - Burn In

Used to Warm up the panel with full-screen solid color. For internal testing purposes only. Please contact your nearest Hatteland Display office, or Service Partner before using this setting.

Service Settings - Smart ISP

Used for Video Scaler firmware update. For experienced personell only, please contact Hatteland Display or Service Partner for more information.

Service Settings - Watchdog Test

Used for internal testing only. For experienced personell only, please contact Hatteland Display or Service Partner for more information.



Operation Advanced (DDC/CI)

Operation Advanced (DDC/CI) Control Overview

Introduction

DDC/CI (Display Data Channel/Command Interface) specifies a means for a computer to send commands to the unit's Display Video Controller to programatically adjust parameters of the display instead of pressing physical buttons or navigate through an OSD menu. Specific commands to control units are defined in a separate official Monitor Control Command Set (MCCS) industry standard. The signal inputs supported are VGA and DVI.

Hatteland Display's Series X (Generation 1) - Maritime Multi Displays (MMD) from 12 to 26 inch will support some of these commands (units with GEV Firmware **160914**) and is gradually implemented in production from **13th of February 2017** and fully implemented for units delivered after **31st of March 2017**.

Reference: http://www.hatteland-display.com/mails/02_2017_ecn.html

To determine if your unit has the DDC/CI commands supported as described in this chapter, please review the "On Screen Display (OSD) Menu" chapter (Service section) in this manual.

It is expected that the user have previous experience of the DDC/CI protocol and how to implement the commands in their own control applications. A suitable starting point for sending commands, are the GUI operated (or command line version) of softMCCS software, reference: <http://www.entechtaiwan.com/lib/softmccs.shtm>

The listed DDC/CI commands below are equivalent to the same functions available in the well implemented Hatteland Display Serial/Ethernet Communication Control Interface (SCOM) protocol, where specified, reference:

Series X - Generation 1: <http://www.hatteland-display.com/pdfink/inb100018-4.php>

Series X - Generation 2: <http://www.hatteland-display.com/pdfink/inb100018-6.php>

The column "SCOM" is a reference and not part of the DDC/CI commands explained in the table below.

Syntax: [S] = Start Condition & [P] = Stop Condition (marked with gray color). Numbers in black/green/red colors are Byte Value in Hexadecimal.

Description	Syntax and Functionality	Details and Values	SCOM Equivalent
User Brightness Control (backlight) (0x10)	<p>Set/write Brightness value: [S] <6E:w> 51 84 03 10 00 xx FD [P]</p> <p>Reply of successful request: [S] <6F:r> FD 80 BE* [P]</p> <p>Read Brightness value: [S] <6E:w> 51 82 01 10 AC [P]</p> <p>Reply of successful request: [S] <6F:r> 6E 88 02 00 10 00 00 64 00 xx 95* [P]</p>	<p>10 = Command ID Where xx = 0 to 64</p> <p>Min-Max Range: 0-100 (0x00-0x64) During Read reply, these values will be present.</p> <p>Read/Write support.</p>	BRT
Glass Display Control™ (GDC) Brilliance Button (0xE2)	<p>Set/write Brilliance Value: [S] <6E:w> 51 84 03 E2 00 xx 68 [P]</p> <p>Reply of successful request: [S] <6F:r> 68 80 BE* [P]</p> <p>Read Brilliance Value: [S] <6E:w> 51 82 01 E2 5E [P]</p> <p>Reply of successful request: [S] <6F:r> 6E 88 02 00 E2 00 00 64 00 xx 00* [P]</p>	<p>E2 = Command ID Where xx = 0 to 64</p> <p>Min-Max Range: 0-100 (0x00-0x64) During Read reply, these values will be present.</p> <p>Read/Write support.</p>	BRU
Buzzer Control (0xE5)	<p>write/Turn ON: [S] <6E:w> 51 84 03 E5 00 01 5C [P]</p> <p>Reply of successful request: [S] <6F:r> 5C 80 BE* [P]</p> <p>Write/Turn OFF: [S] <6E:w> 51 84 03 E5 00 00 5D [P]</p> <p>Reply of successful Turn OFF request: [S] <6F:r> 5D 80 BE* [P]</p>	<p>E5 = Command ID Where 01 = Turn On Where 00 = Turn Off</p> <p>Write Support only.</p>	BZZ

Operation Advanced (DDC/CI) Control Overview

<p>Color Mode: Kelvin Color Tempearture (0x14)</p>	<p>Set/Write Color Temperature: [S] <6E:w> 51 84 03 14 00 ww xx [P] Reply of successfull request: [S] <6F:r> xx 80 BE* [P]</p> <p>Read Color Temperature Value: [S] <6E:w> 51 82 01 14 A8 [P] Reply of successfull request: [S] <6F:r> 6E 88 02 00 14 00 00 0E 00 yy zz* [P]</p>	<p>14 = Command ID Where Write ww xx 05 A9 = 6500 07 AB = 8000 08 A4 = 9300</p> <p>Where Read yy zz 05 AB = 6500 07 A9 = 8000 08 A6 = 9300</p> <p>Read/Write support.</p>	<p>MCC: (Color Temperature Select)</p>
<p>Gamma Calibration (0x14)</p>	<p>Set/Write Calibration: [S] <6E:w> 51 84 03 14 00 ww xx [P] Reply of successfull request: [S] <6F:r> xx 80 BE* [P]</p> <p>Read Calibration: [S] <6E:w> 51 82 01 14 A8 [P] Reply of successfull request: [S] <6F:r> 6E 88 02 00 14 00 00 0E 00 yy zz* [P]</p>	<p>14 = Command ID Where Write ww xx 0C A0 = VGA 0D A1 = DVI</p> <p>Where Read yy zz 0C A2 = VGA 0D A3 = DVI</p> <p>Read/Write support.</p>	<p>MCC: (Gamma (Calibration))</p>

This page left intentionally blank



Specifications

Specifications - HD 15T22 MMD-xxx-Fxxx

All specifications are subject to change without prior notice!

TFT Technology:

- High Quality TFT with LED Backlight Technology
- 15.0 inch viewable image size, Aspect Ratio 4:3
- TFT active-matrix liquid crystal panel

TFT Characteristics:

- Native Resolution : 1024 x 768
- Pixel Pitch (RGB) : 0.297 (H) x 0.297 (V) mm
- Response Time Standard : 8ms (typical), black to white
- Response Time High Bright : 19ms (typical), black to white
- Contrast Ratio Standard : 1500:1 (typical)
- Contrast Ratio High Bright : 800:1 (typical)
- Light Intensity Standard : 400 cd/m² (typical)
- Light Intensity High Bright : 800 cd/m² (typical)
- Viewable Angle Standard : +/- 85 deg. (Up/Down/Left/Right) (typical)
- Viewable Angle High Bright : +/- 80 deg. (D/L/R), +/- 60 deg. (U) (typ)
- Active Display Area : 304.1 (H) x 228.1 (V) mm
- Max Colors : 16.7 million

Synchronization:

- Digital separate synchronization
- Composite synchronization
- Synchronization on green
- Auto detects VGA -> XGA, interlaced and non interlaced
- Video Signal : Analog RGB 0,7Vp-p
- Input Impedance 75 Ohm

Synchronization Range:

- Horizontal : 31.5 kHz to 91.1 kHz
- Vertical : 60 Hz* to 85 Hz

* Recommended for optimal picture quality

Supported Signals:

Resolutions:

- VGA : 640 x 480 (including 640 x 350)
- SVGA : 800 x 600 (including 720 x 400)
- XGA : 1024 x 768*

* Recommended for optimal picture quality

Video Signals:

- Interlaced HDTV, NTSC, PAL and SECAM video
- Composite video

Power Specifications:

Multi-power Supply:

- 115&230VAC - 50/60Hz + 24 VDC

Note: You may connect either AC power or DC power or both. In case both sources are connected, power will be sourced from the AC input. If AC input is lost, there will be a uninterrupted switch-over to DC input.

Power Consumption:

- Operating AC/DC: 22W (max)

Physical Considerations:

- W:356.00 [14.02"] x H:307.00 [12.09"] x D:71.50 [2.81"] mm [inch]
- Weight: 5.6kg / 12.3lbs

Signal Terminals:

- DVI-I IN : 2 x 29p DVI Female (or as VGA IN with adapter)*
- DP1.2 IN : 1 x 20p DisplayPort (female)
- Comp. Video IN : 2 x BNC Connector (female)
- SCOM RS-422/485 : 2 x 5-pin Terminal Block 3.81, non-isolated+Buzzer
- VGA OUT : 1 x 15p HD D-SUB (female) - Clone of VGA IN**
- SCOM+Touch : 1 x USB TYPE A Connector (female)
- Ethernet : 1 x RJ45 Connector for Remote Control
- SCOM RS-232 : 1 x 9p D-SUB (female) non-isolated+Buzzer
- Potmeter/User : 1 x 9p D-SUB (male)
(Potentiometer IN, +5VDC OUT, BRT +/- IN)
- AC Power IN : 1 x Std IEC Inlet
- DC Power IN : 1 x 2-pin Terminal Block 5.08

* DVI-I Port #1 as VGA IN also acts as clone to VGA Signal Out (buffered).

**Tested at recommended resolutions. The VGA output signal (buffered) is at same resolution and sync as the VGA input. The output is working even if the display unit is turned off, but power cable/supply must be connected/provided.

User Controls:

Behind front bezel - Glass Display Control™ (GDC) IP66:

- Power On/Off, On Screen Display Menu, Brightness Control (-/+)
- Hotkeys (left/right), Mode Status Indicators (Service)
- Buzzer (through glass), Light Sensor (behind glass)

Environmental Considerations:

- Operating : Temperature -15 deg. C to +55 deg. C
- Storage : Temperature -30 deg. C to +70 deg. C
- Humidity : Up to 95%
- IP Rating : Protection: IP66 front – IP22 rear (EN60529)
- Compass Safe Dist. : Standard: 100cm - Steering: 65cm

Lifetime Considerations:

Even although the test conditions for bridge units provide for a maximum operating temperature of 55°C, continuous operation of all electronic components should, if possible, take place at ambient temperatures of only 25°C. This is a necessary prerequisite for long life and low service costs.

Available Accessories:

- HD CMB SX2-A1 : 1 x Console Mount Kit. EN60945 Tested
 - HD TMB SX2-A1 : 1 x Table Mount Bracket. EN60945 Tested
 - HD VED SX2-A1 : 1 x VESA Adapter Kit (75/75, 100/100 & 200/100mm)
Not EN60945 Tested
 - JH 15TAP STD-C1 : 1 x Frame Adapter (15" Series 1 to Series X) retrofit
 - HD REM SX1-A1 : 1 x External Remote Control, EN60945 Tested
 - HD 15COV SX1-A1 : 1 x UV Sun Cover
 - P006997-1 : 1 x IP66 Mount Gasket (EPDM), for Flush/Console mount
- Please see user manual/datasheet for more information

Factory Options:

- Projected Capacitive Touch Screen (Multitouch, USB, Pen/Glove supported)
- Optical Bonding Technology
- Sunlight Readable / High Bright (includes Optical Bonding)

APPROVALS & CERTIFICATES

These products have been tested / type approved by the following classification societies (*=pending):

IEC 60945 4th (EN 60945:2002)

IACS E10

EU RO MR* - Mutual Recognition (covers DNV, BV, ABS, GL, NK and LRS certificates)

Specifications - HD 15T22 MMD-xxx-FHxx

All specifications are subject to change without prior notice!

TFT Technology:

- High Quality TFT with LED Backlight Technology
- Sunlight Readable / High Bright (includes Optical Bonding Technology)
- 15.0 inch viewable image size, Aspect Ratio 4:3
- TFT active-matrix liquid crystal panel

TFT Characteristics:

- Native Resolution : 1024 x 768
- Pixel Pitch (RGB) : 0.297 (H) x 0.297 (V) mm
- Response Time : 19ms (typical), black to white
- Contrast Ratio : 800:1 (typical)
- Light Intensity : 800 cd/m² (typical)
- Viewable Angle : +/- 80 deg. (D/L/R), +/- 60 deg. (U) (typ)
- Active Display Area : 304.1 (H) x 228.1 (V) mm
- Max Colors : 16.7 million

Synchronization:

- Digital separate synchronization
- Composite synchronization
- Synchronization on green
- Auto detects VGA -> XGA, interlaced and non interlaced
- Video Signal : Analog RGB 0,7Vp-p
- Input Impedance 75 Ohm

Synchronization Range:

- Horizontal : 31.5 kHz to 91.1 kHz
- Vertical : 60 Hz* to 85 Hz

* Recommended for optimal picture quality

Supported Signals:

Resolutions:

- VGA : 640 x 480 (including 640 x 350)
- SVGA : 800 x 600 (including 720 x 400)
- XGA : 1024 x 768*

* Recommended for optimal picture quality

Video Signals:

- Interlaced HDTV, NTSC, PAL and SECAM video
- Composite video

Power Specifications:

Multi-power Supply:

- 115&230VAC - 50/60Hz + 24 VDC

Note: You may connect either AC power or DC power or both. In case both sources are connected, power will be sourced from the AC input. If AC input is lost, there will be a uninterrupted switch-over to DC input.

Power Consumption:

- Operating AC/DC: TBDW (max)

Physical Considerations:

- W:356.00 [14.02"] x H:307.00 [12.09"] x D:78.50 [3.09"] mm [inch]
- Weight: 5.6kg / 12.3lbs
- Delivery includes an EPDM sealing gasket for IP66 console mount.

Signal Terminals:

- DVI-I IN : 2 x 29p DVI Female (or as VGA IN with adapter)*
- DP1.2 IN : 1 x 20p DisplayPort (female)
- Comp. Video IN : 2 x BNC Connector (female)
- SCOM RS-422/485 : 2 x 5-pin Terminal Block 3.81, non-isolated+Buzzer
- VGA OUT : 1 x 15p HD D-SUB (female) - Clone of VGA IN**
- SCOM+Touch : 1 x USB TYPE A Connector (female)
- Ethernet : 1 x RJ45 Connector for Remote Control
- SCOM RS-232 : 1 x 9p D-SUB (female) non-isolated+Buzzer
- Potmeter/User : 1 x 9p D-SUB (male)
- (Potentiometer IN, +5VDC OUT, BRT +/- IN)
- AC Power IN : 1 x Std IEC Inlet
- DC Power IN : 1 x 2-pin Terminal Block 5.08

* DVI-I Port #1 as VGA IN also acts as clone to VGA Signal Out (buffered).

**Tested at recommended resolutions. The VGA output signal (buffered) is at same resolution and sync as the VGA input. The output is working even if the display unit is turned off, but power cable/supply must be connected/provided.

User Controls:

Behind front bezel - Glass Display Control™ (GDC) IP66:

- Power On/Off, On Screen Display Menu, Brightness Control (-/+)
- Hotkeys (left/right), Mode Status Indicators (Service)
- Buzzer (through glass), Light Sensor (behind glass)

Environmental Considerations:

- Operating : Temperature -15 deg. C to +55 deg. C
- Storage : Temperature -30 deg. C to +70 deg. C
- Humidity : Up to 95%
- IP Rating : Protection: IP66 front – IP22 rear (EN60529)
- Compass Safe Dist. : Standard: 100cm - Steering: 65cm

Lifetime Considerations:

Even although the test conditions for bridge units provide for a maximum operating temperature of 55°C, continuous operation of all electronic components should, if possible, take place at ambient temperatures of only 25°C. This is a necessary prerequisite for long life and low service costs.

Available Accessories:

- HD CMB SX2-A1 : 1 x Console Mount Kit. EN60945 Tested
- HD TMB SX2-A1 : 1 x Table Mount Bracket. EN60945 Tested
- HD VED SX2-A1 : 1 x VESA Adapter Kit (75/75, 100/100 & 200/100mm) Not EN60945 Tested
- JH 15TAP STD-C1 : 1 x Frame Adapter (15" Series 1 to Series X) retrofit
- HD REM SX1-A1 : 1 x External Remote Control, EN60945 Tested
- HD 15COV SX1-A1 : 1 x UV Sun Cover
- P006997-1 : 1 x IP66 Mount Gasket (EPDM), for Flush/Console mount

Please see user manual/datasheet for more information

Factory Options:

- Projected Capacitive Touch Screen (Multitouch, USB, Pen/Glove supported)

APPROVALS & CERTIFICATES

These products have been tested / type approved by the following classification societies (*=pending):

IEC 60945 4th (EN 60945:2002)

IACS E10

EU RO MR* - Mutual Recognition (covers DNV, BV, ABS, GL, NK and LRS certificates)

Specifications - HD 17T22 MMD-xxx-Fxxx

All specifications are subject to change without prior notice!

TFT Technology:

- High Quality TFT with LED Backlight Technology
- 17.0 inch viewable image size, Aspect Ratio 5:4
- TFT active-matrix liquid crystal panel

TFT Characteristics:

- Native Resolution : 1280 x 1024
- Pixel Pitch (RGB) : 0.264 (H) x 0.264 (V) mm
- Response Time : 5ms (typical), "black" to "white"
- Contrast Ratio : 1000:1 (typical)
- Light Intensity Standard : 350 cd/m² (typical)
- Light Intensity High Bright : 1000 cd/m² (typical)
- Viewable Angle : +/- 80° (Down/Left/Right), 60° (Up) (typ)
- Active Display Area : 337.92 (H) x 270.336 (V) mm
- Max Colors : 16.7 million

Synchronization:

- Digital separate synchronization
- Composite synchronization
- Synchronization on green
- Auto detects VGA -> SXGA, interlaced and non interlaced
- Video Signal : Analog RGB 0,7Vp-p
- : Input Impedance 75 Ohm

Synchronization Range:

- Horizontal : 31.5 kHz to 91.1 kHz
- Vertical : 60 Hz* to 85 Hz

* Recommended for optimal picture quality

Supported Signals:

Resolutions:

- VGA : 640 x 480 (including 640 x 350)
- SVGA : 800 x 600 (including 720 x 400)
- XGA : 1024 x 768
- SXGA : 1280 x 1024*

* Recommended for optimal picture quality

Video Signals:

- Interlaced HDTV, NTSC, PAL and SECAM video
- Composite video

Power Specifications:

Multi-power Supply:

- 115&230VAC - 50/60Hz + 24 VDC

Note: You may connect either AC power or DC power or both. In case both sources are connected, power will be sourced from the AC input. If AC input is lost, there will be a uninterrupted switch-over to DC input.

Power Consumption:

- Operating AC/DC: 34W (max)

Physical Considerations:

- W:390.00 [15.35"] x H:351.00 [13.82"] x D:71.50 [2.81"] mm [inch]
- Weight: 6.7kg / 14.7lbs

Signal Terminals:

- DVI-I IN : 2 x 29p DVI Female (or as VGA IN with adapter)*
- DP1.2 IN : 1 x 20p DisplayPort (female)
- Comp. Video IN : 2 x BNC Connector (female)
- SCOM RS-422/485 : 2 x 5-pin Terminal Block 3.81, non-isolated+Buzzer
- VGA OUT : 1 x 15p HD D-SUB (female) - Clone of VGA IN**
- SCOM+Touch : 1 x USB TYPE A Connector (female)
- Ethernet : 1 x RJ45 Connector for Remote Control
- SCOM RS-232 : 1 x 9p D-SUB (female) non-isolated+Buzzer
- Potmeter/User : 1 x 9p D-SUB (male)
(Potentiometer IN, +5VDC OUT, BRT +/- IN)
- AC Power IN : 1 x Std IEC Inlet
- DC Power IN : 1 x 2-pin Terminal Block 5.08

* DVI-I Port #1 as VGA IN also acts as clone to VGA Signal Out (buffered).

**Tested at recommended resolutions. The VGA output signal (buffered) is at same resolution and sync as the VGA input. The output is working even if the display unit is turned off, but power cable/supply must be connected/provided.

User Controls:

Behind front bezel - Glass Display Control™ (GDC) IP66:

- Power On/Off, On Screen Display Menu, Brightness Control (-/+)
- Hotkeys (left/right), Mode Status Indicators (ECDIS, Service)
- Buzzer (through glass), Light Sensor (behind glass)

Environmental Considerations:

- Operating : Temperature -15 deg. C to +55 deg. C
- Storage : Temperature -30 deg. C to +70 deg. C
- Humidity : Up to 95%
- IP Rating : Protection: IP66 front – IP22 rear (EN60529)
- Compass Safe Dist. : Standard: 125cm - Steering: 85cm

Lifetime Considerations:

Even although the test conditions for bridge units provide for a maximum operating temperature of 55°C, continuous operation of all electronic components should, if possible, take place at ambient temperatures of only 25°C. This is a necessary prerequisite for long life and low service costs.

Available Accessories:

- HD CMB SX2-A1 : 1 x Console Mount Kit. EN60945 Tested
 - HD TMB SX2-A1 : 1 x Table Mount Bracket. EN60945 Tested
 - HD VED SX2-B1 : 1 x VESA Adapter Kit (75/75, 100/100 & 200/100mm)
Not EN60945 Tested
 - HD REM SX1-A1 : 1 x External Remote Control, EN60945 Tested
 - HD 17COV SX1-A1 : 1 x UV Sun Cover
 - P007130-1 : 1 x IP66 Mount Gasket (EPDM), for Flush/Console mount
- Please see user manual/datasheet for more information

Factory Options:

- Projected Capacitive Touch Screen (Multitouch, USB, Pen/Glove supported)
- Optical Bonding Technology
- Color Calibrated models (ECDIS)
- Sunlight Readable / High Bright (includes Optical Bonding)

APPROVALS & CERTIFICATES

These products have been tested / type approved by the following classification societies (*=pending):

IEC 60945 4th (EN 60945:2002)

IACS E10

EU RO MR* - Mutual Recognition (covers DNV, BV, ABS, GL, NK and LRS certificates)

Specifications - HD 17T22 MMD-xxx-FHxx

All specifications are subject to change without prior notice!

TFT Technology:

- High Quality TFT with LED Backlight Technology
- Sunlight Readable / High Bright (includes Optical Bonding Technology)
- 17.0 inch viewable image size, Aspect Ratio 5:4
- TFT active-matrix liquid crystal panel

TFT Characteristics:

- Native Resolution : 1280 x 1024
- Pixel Pitch (RGB) : 0.264 (H) x 0.264 (V) mm
- Response Time : 5ms (typical), "black" to "white"
- Contrast Ratio : 1000:1 (typical)
- Light Intensity : 1000 cd/m² (typical)
- Viewable Angle @ CR>10 : +/- 80° (Down/Left/Right), 60° (Up) (typ)
- Active Display Area : 337.92 (H) x 270.336 (V) mm
- Max Colors : 16.7 million

Synchronization:

- Digital separate synchronization
- Composite synchronization
- Synchronization on green
- Auto detects VGA -> SXGA, interlaced and non interlaced
- Video Signal : Analog RGB 0,7Vp-p
- Input Impedance 75 Ohm

Synchronization Range:

- Horizontal : 31.5 kHz to 91.1 kHz
- Vertical : 60 Hz* to 85 Hz

* Recommended for optimal picture quality

Supported Signals:

Resolutions:

- VGA : 640 x 480 (including 640 x 350)
- SVGA : 800 x 600 (including 720 x 400)
- XGA : 1024 x 768
- SXGA : 1280 x 1024*

* Recommended for optimal picture quality

Video Signals:

- Interlaced HDTV, NTSC, PAL and SECAM video
- Composite video

Power Specifications:

Multi-power Supply:

- 115&230VAC - 50/60Hz + 24 VDC

Note: You may connect either AC power or DC power or both. In case both sources are connected, power will be sourced from the AC input. If AC input is lost, there will be a uninterrupted switch-over to DC input.

Power Consumption:

- Operating AC/DC: TBDW (max)

Physical Considerations:

- W:390.00 [15.35"] x H:351.00 [13.82"] x D:78.50 [3.09"] mm [inch]
- Weight: 6.7kg / 14.7lbs
- Delivery includes an EPDM sealing gasket for IP66 console mount.

Signal Terminals:

- DVI-I IN : 2 x 29p DVI Female (or as VGA IN with adapter)*
- DP1.2 IN : 1 x 20p DisplayPort (female)
- Comp. Video IN : 2 x BNC Connector (female)
- SCOM RS-422/485 : 2 x 5-pin Terminal Block 3.81, non-isolated+Buzzer
- VGA OUT : 1 x 15p HD D-SUB (female) - Clone of VGA IN**
- SCOM+Touch : 1 x USB TYPE A Connector (female)
- Ethernet : 1 x RJ45 Connector for Remote Control
- SCOM RS-232 : 1 x 9p D-SUB (female) non-isolated+Buzzer
- Potmeter/User : 1 x 9p D-SUB (male)
(Potentiometer IN, +5VDC OUT, BRT +/- IN)
- AC Power IN : 1 x Std IEC Inlet
- DC Power IN : 1 x 2-pin Terminal Block 5.08

* DVI-I Port #1 as VGA IN also acts as clone to VGA Signal Out (buffered).

**Tested at recommended resolutions. The VGA output signal (buffered) is at same resolution and sync as the VGA input. The output is working even if the display unit is turned off, but power cable/supply must be connected/provided.

User Controls:

Behind front bezel - Glass Display Control™ (GDC) IP66:

- Power On/Off, On Screen Display Menu, Brightness Control (-/+)
- Hotkeys (left/right), Mode Status Indicators (ECDIS, Service)
- Buzzer (through glass), Light Sensor (behind glass)

Environmental Considerations:

- Operating : Temperature -15 deg. C to +55 deg. C
- Storage : Temperature -30 deg. C to +70 deg. C
- Humidity : Up to 95%
- IP Rating : Protection: IP66 front – IP22 rear (EN60529)
- Compass Safe Dist. : Standard: 100cm - Steering: 70cm

Lifetime Considerations:

Even although the test conditions for bridge units provide for a maximum operating temperature of 55°C, continuous operation of all electronic components should, if possible, take place at ambient temperatures of only 25°C. This is a necessary prerequisite for long life and low service costs.

Available Accessories:

- HD CMB SX2-A1 : 1 x Console Mount Kit. EN60945 Tested
- HD TMB SX2-A1 : 1 x Table Mount Bracket. EN60945 Tested
- HD VED SX2-B1 : 1 x VESA Adapter Kit (75/75, 100/100 & 200/100mm)
Not EN60945 Tested
- HD REM SX1-A1 : 1 x External Remote Control, EN60945 Tested
- HD 17COV SX1-A1 : 1 x UV Sun Cover
- P007130-1 : 1 x IP66 Mount Gasket (EPDM), for Flush/Console mount

Please see user manual/datasheet for more information

Factory Options:

- Projected Capacitive Touch Screen (Multitouch, USB, Pen/Glove supported)
- Color Calibrated models (ECDIS)

APPROVALS & CERTIFICATES

These products have been tested / type approved by the following classification societies (*=pending):

IEC 60945 4th (EN 60945:2002)

IACS E10

EU RO MR* - Mutual Recognition (covers DNV, BV, ABS, GL, NK and LRS certificates)

Specifications - HD 19T22 MMD-xxx-Fxxx

All specifications are subject to change without prior notice!

TFT Technology:

- High Quality TFT with LED Backlight Technology
- 19.0 inch viewable image size, Aspect Ratio 5:4
- TFT active-matrix liquid crystal panel
- MVA (Multi-domain Vertical Alignment) LCD Technology

TFT Characteristics:

- Native Resolution : 1280 x 1024
- Pixel Pitch (RGB) : 0.294 (H) x 0.294 (V) mm
- Response Time : 20ms (typical), "black" to "white"
- Contrast Ratio Standard : 1500:1 (typical)
- Contrast Ratio High Bright : 1000:1 (typical)
- Light Intensity Standard : 350 cd/m² (typical)
- Light Intensity High Bright : 1000 cd/m² (typical)
- Viewable Angle Standard : +/- 85 deg. (typical) (Up/Down/Left/Right)
- Viewable Angle High Bright : +/- 89 deg. (typical) (Up/Down/Left/Right)
- Active Display Area : 376.32 (H) x 301.056 (V) mm
- Max Colors : 16.7 million

Synchronization:

- Digital separate synchronization
- Composite synchronization
- Synchronization on green
- Auto detects VGA -> SXGA, interlaced and non interlaced
- Video Signal : Analog RGB 0,7Vp-p
- Input Impedance 75 Ohm

Synchronization Range:

- Horizontal : 31.5 kHz to 91.1 kHz
- Vertical : 60 Hz* to 85 Hz

* Recommended for optimum picture quality

Supported Signals:

Resolutions:

- VGA : 640 x 480 (including 640 x 350)
- SVGA : 800 x 600 (including 720 x 400)
- XGA : 1024 x 768
- SXGA : 1280 x 1024*

* Recommended for optimum picture quality

Video Signals:

- Interlaced HDTV, NTSC, PAL and SECAM video
- Composite video

Power Specifications:

Multi-power Supply:

- 115&230VAC - 50/60Hz + 24 VDC

Note: You may connect either AC power or DC power or both. In case both sources are connected, power will be sourced from the AC input. If AC input is lost, there will be a uninterrupted switch-over to DC input.

Power Consumption:

- Operating AC/DC: 32W (max)

Physical Considerations:

- W:429.00 [16.89"] x H:382.00 [15.04"] x D:71.50 [2.81"] mm [inch]
- Weight: 6.8kg / 15.0lbs

Signal Terminals:

- DVI-I IN : 2 x 29p DVI Female (or as VGA IN with adapter)*
- DP1.2 IN : 1 x 20p DisplayPort (female)
- Comp. Video IN : 2 x BNC Connector (female)
- SCOM RS-422/485 : 2 x 5-pin Terminal Block 3.81, non-isolated+Buzzer
- VGA OUT : 1 x 15p HD D-SUB (female) - Clone of VGA IN**
- SCOM+Touch : 1 x USB TYPE A Connector (female)
- Ethernet : 1 x RJ45 Connector for Remote Control
- SCOM RS-232 : 1 x 9p D-SUB (female) non-isolated+Buzzer
- Potmeter/User : 1 x 9p D-SUB (male)
(Potentiometer IN, +5VDC OUT, BRT +/- IN)
- AC Power IN : 1 x Std IEC Inlet
- DC Power IN : 1 x 2-pin Terminal Block 5.08

* DVI-I Port #1 as VGA IN also acts as clone to VGA Signal Out (buffered).

**Tested at recommended resolutions. The VGA output signal (buffered) is at same resolution and sync as the VGA input. The output is working even if the display unit is turned off, but power cable/supply must be connected/provided.

User Controls:

Behind front bezel - Glass Display Control™ (GDC) IP66:

- Power On/Off, On Screen Display Menu, Brightness Control (-/+)
- Hotkeys (left/right), Mode Status Indicators (ECDIS, Service)
- Buzzer (through glass), Light Sensor (behind glass)

Environmental Considerations:

- Operating : Temperature -15 deg. C to +55 deg. C
- Storage : Temperature -30 deg. C to +70 deg. C
- Humidity : Up to 95%
- IP Rating : Protection: IP66 front - IP22 rear (EN60529)
- Compass Safe Dist. : Standard: 90cm - Steering: 45cm

Lifetime Considerations:

Even although the test conditions for bridge units provide for a maximum operating temperature of 55°C, continuous operation of all electronic components should, if possible, take place at ambient temperatures of only 25°C. This is a necessary prerequisite for long life and low service costs.

Available Accessories:

- HD CMB SX2-A1 : 1 x Console Mount Kit. EN60945 Tested
 - HD TMB SX2-A1 : 1 x Table Mount Bracket. EN60945 Tested
 - HD VED SX2-C1 : 1 x VESA Adapter Kit (75/75, 100/100 & 200/100mm)
Not EN60945 Tested
 - JH 19TAP STD-C1 : 1 x Frame Adapter (19" Series 1 to Series X) retrofit
 - HD 19TAP SX2-C2 : 1 x Frame Adapter (19" Series X to Series 2) retrofit
 - HD REM SX1-A1 : 1 x External Remote Control, EN60945 Tested
 - HD 19COV SX1-A1 : 1 x UV Sun Cover
 - P007131-1 : 1 x IP66 Mount Gasket (EPDM), for Flush/Console mount
- Please see user manual/datasheet for more information

Factory Options:

- Projected Capacitive Touch Screen (Multitouch, USB, Pen/Glove supported)
- Optical Bonding Technology
- Color Calibrated models (ECDIS)
- Sunlight Readable / High Bright (includes Optical Bonding)

APPROVALS & CERTIFICATES

These products have been tested / type approved by the following classification societies (*=pending):

IEC 60945 4th (EN 60945:2002)

IACS E10

EU RO MR* - Mutual Recognition (covers DNV, BV, ABS, GL, NK and LRS certificates)

Specifications - HD 19T22 MMD-xxx-FHxx

All specifications are subject to change without prior notice!

TFT Technology:

- High Quality TFT with LED Backlight Technology
- Sunlight Readable / High Bright (includes Optical Bonding Technology)
- 19.0 inch viewable image size, Aspect Ratio 5:4
- TFT active-matrix liquid crystal panel
- MVA (Multi-domain Vertical Alignment) LCD Technology

TFT Characteristics:

- Native Resolution : 1280 x 1024
- Pixel Pitch (RGB) : 0.294 (H) x 0.294 (V) mm
- Response Time : 20ms (typical), "black" to "white"
- Contrast Ratio : 1000:1 (typical)
- Light Intensity : 1000 cd/m² (typical)
- Viewable Angle : +/- 89 deg. (typical) (Up/Down/Left/Right)
- Active Display Area : 376.32 (H) x 301.056 (V) mm
- Max Colors : 16.7 million

Synchronization:

- Digital separate synchronization
- Composite synchronization
- Synchronization on green
- Auto detects VGA -> SXGA, interlaced and non interlaced
- Video Signal : Analog RGB 0,7Vp-p
- : Input Impedance 75 Ohm

Synchronization Range:

- Horizontal : 31.5 kHz to 91.1 kHz
- Vertical : 60 Hz* to 85 Hz

* Recommended for optimum picture quality

Supported Signals:

Resolutions:

- VGA : 640 x 480 (including 640 x 350)
- SVGA : 800 x 600 (including 720 x 400)
- XGA : 1024 x 768
- SXGA : 1280 x 1024*

* Recommended for optimum picture quality

Video Signals:

- Interlaced HDTV, NTSC, PAL and SECAM video
- Composite video

Power Specifications:

Multi-power Supply:

- 115&230VAC - 50/60Hz + 24 VDC

Note: You may connect either AC power or DC power or both. In case both sources are connected, power will be sourced from the AC input. If AC input is lost, there will be a uninterrupted switch-over to DC input.

Power Consumption:

- Operating AC/DC: TBDW (max)

Physical Considerations:

- W:429.00 [16.89"] x H:382.00 [15.04"] x D:78.50 [3.09"] mm [inch]
- Weight: 6.8kg / 15.0lbs

Signal Terminals:

- DVI-I IN : 2 x 29p DVI Female (or as VGA IN with adapter)*
- DP1.2 IN : 1 x 20p DisplayPort (female)
- Comp. Video IN : 2 x BNC Connector (female)
- SCOM RS-422/485 : 2 x 5-pin Terminal Block 3.81, non-isolated+Buzzer
- VGA OUT : 1 x 15p HD D-SUB (female) - Clone of VGA IN**
- SCOM+Touch : 1 x USB TYPE A Connector (female)
- Ethernet : 1 x RJ45 Connector for Remote Control
- SCOM RS-232 : 1 x 9p D-SUB (female) non-isolated+Buzzer
- Potmeter/User : 1 x 9p D-SUB (male)
(Potentiometer IN, +5VDC OUT, BRT +/- IN)
- AC Power IN : 1 x Std IEC Inlet
- DC Power IN : 1 x 2-pin Terminal Block 5.08

* DVI-I Port #1 as VGA IN also acts as clone to VGA Signal Out (buffered).

**Tested at recommended resolutions. The VGA output signal (buffered) is at same resolution and sync as the VGA input. The output is working even if the display unit is turned off, but power cable/supply must be connected/provided.

User Controls:

Behind front bezel - Glass Display Control™ (GDC) IP66:

- Power On/Off, On Screen Display Menu, Brightness Control (-/+)
- Hotkeys (left/right), Mode Status Indicators (ECDIS, Service)
- Buzzer (through glass), Light Sensor (behind glass)

Environmental Considerations:

- Operating : Temperature -15 deg. C to +55 deg. C
- Storage : Temperature -30 deg. C to +70 deg. C
- Humidity : Up to 95%
- IP Rating : Protection: IP66 front – IP22 rear (EN60529)
- Compass Safe Dist. : Standard: 90cm - Steering: 45cm

Lifetime Considerations:

Even although the test conditions for bridge units provide for a maximum operating temperature of 55°C, continuous operation of all electronic components should, if possible, take place at ambient temperatures of only 25°C. This is a necessary prerequisite for long life and low service costs.

Available Accessories:

- HD CMB SX2-A1 : 1 x Console Mount Kit. EN60945 Tested
 - HD TMB SX2-A1 : 1 x Table Mount Bracket. EN60945 Tested
 - HD VED SX2-C1 : 1 x VESA Adapter Kit (75/75, 100/100 & 200/100mm)
Not EN60945 Tested
 - JH 19TAP STD-C1 : 1 x Frame Adapter (19" Series 1 to Series X) retrofit
 - HD 19TAP SX2-C2 : 1 x Frame Adapter (19" Series X to Series 2) retrofit
 - HD REM SX1-A1 : 1 x External Remote Control, EN60945 Tested
 - HD 19COV SX1-A1 : 1 x UV Sun Cover
 - P007131-1 : 1 x IP66 Mount Gasket (EPDM), for Flush/Console mount
- Please see user manual/datasheet for more information

Factory Options:

- Projected Capacitive Touch Screen (Multitouch, USB, Pen/Glove supported)
- Color Calibrated models (ECDIS)

APPROVALS & CERTIFICATES

These products have been tested / type approved by the following classification societies (*=pending):

IEC 60945 4th (EN 60945:2002)

IACS E10

EU RO MR* - Mutual Recognition (covers DNV, BV, ABS, GL, NK and LRS certificates)

Specifications - HD 24T22 MMD-xxx-Fxxx

All specifications are subject to change without prior notice!

TFT Technology:

- LED Backlight Technology, TFT Active-matrix
- 24.0 inch viewable image size, Widescreen, Aspect Ratio 16:9
- MVA (Multi-domain Vertical Alignment) LCD Technology, RGB vertical stripe

TFT Characteristics:

- Native Resolution : 1920 x 1080 (FHD)
- Pixel Pitch (RGB) : 0.276 (H) x 0.276 (V) mm
- Response Time : 25 ms (typical), "black" to "white"
- Contrast Ratio : 3000:1 (typical)
- Light Intensity Standard : 300 cd/m² (typical)
- Light Intensity High Bright : 1000 cd/m² (typical)
- Viewable Angle : +/- 89 deg. (typical) (Up/Down/Left/Right)
- Active Display Area : 531.36 (H) x 298.89 (V) mm
- Max Colors : 16.7 millions (RGB 8-bit)

Synchronization:

- Digital separate synchronization
- Composite synchronization
- Synchronization on green
- Auto detects VGA -> WUXGA, interlaced and non interlaced
- Video Signal : Analog RGB 0,7Vp-p
- Input Impedance 75 Ohm

Synchronization Range:

- Horizontal : 31.5 kHz to 91.1 kHz
- Vertical : 60 Hz* to 85 Hz

* Recommended for optimal picture quality

Supported Signals:

Resolutions:

- VGA : 640 x 480 (including 640 x 350)
- SVGA : 800 x 600 (including 720 x 400)
- XGA : 1024 x 768
- SXGA : 1280 x 1024
- UXGA : 1600 x 1200
- FHD : 1920 x 1080*
- WUXGA : 1920 x 1200

* Recommended for optimal picture quality

Video Signals:

- Interlaced HDTV, NTSC, PAL and SECAM video
- Composite video

Power Specifications:

Multi-power Supply:

- 115&230VAC - 50/60Hz + 24 VDC

Note: You may connect either AC power or DC power or both. In case both sources are connected, power will be sourced from the AC input. If AC input is lost, there will be a uninterrupted switch-over to DC input.

Power Consumption:

- Operating AC/DC: 51W (max)

Physical Considerations:

- W:593.00 [23.35"] x H:384.00 [15.12"] x D:70.00 [2.76"] mm [inch]
- Weight: 8.6kg / 18.9lbs

Signal Terminals:

- DVI-I IN : 2 x 29p DVI Female (or as VGA IN with adapter)*
- DP1.2 IN : 1 x 20p DisplayPort (female)
- Comp. Video IN : 2 x BNC Connector (female)
- SCOM RS-422/485 : 2 x 5-pin Terminal Block 3.81, non-isolated+Buzzer
- VGA OUT : 1 x 15p HD D-SUB (female) - Clone of VGA IN**
- SCOM+Touch : 1 x USB TYPE A Connector (female)
- Ethernet : 1 x RJ45 Connector for Remote Control
- SCOM RS-232 : 1 x 9p D-SUB (female) non-isolated+Buzzer
- Potmeter/User : 1 x 9p D-SUB (male)
(Potentiometer IN, +5VDC OUT, BRT +/- IN)
- AC Power IN : 1 x Std IEC Inlet
- DC Power IN : 1 x 2-pin Terminal Block 5.08

* DVI-I Port #1 as VGA IN also acts as clone to VGA Signal Out (buffered).

**Tested at recommended resolutions. The VGA output signal (buffered) is at same resolution and sync as the VGA input. The output is working even if the display unit is turned off, but power cable/supply must be connected/provided.

User Controls:

Behind front bezel - Glass Display Control™ (GDC) IP66:

- Power On/Off, On Screen Display Menu, Brightness Control (-/+)
- Hotkeys (left/right), Mode Status Indicators (ECDIS, Service)
- Buzzer (through glass), Light Sensor (behind glass)

Environmental Considerations:

- Operating : Temperature -15 deg. C to +55 deg. C
- Storage : Temperature -30 deg. C to +70 deg. C
- Humidity : Up to 95%
- IP Rating : Protection: IP66 front – IP22 rear (EN60529)
- Compass Safe Dist. : Standard: 140cm - Steering: 85cm

Lifetime Considerations:

Even although the test conditions for bridge units provide for a maximum operating temperature of 55°C, continuous operation of all electronic components should, if possible, take place at ambient temperatures of only 25°C. This is a necessary prerequisite for long life and low service costs.

Available Accessories:

- HD CMB SX2-E1 : 1 x Console Mount Kit. EN60945 Tested
 - HD TMB SX1-C1 : 1 x Table Mount Bracket. EN60945 Tested
 - HD VED SX2-H1 : 1 x VESA Adapter Kit (75/75, 100/100 & 200/100mm)
Not EN60945 Tested
 - HD REM SX1-A1 : 1 x External Remote Control, EN60945 Tested
 - HD 24COV SX1-A1 : 1 x UV Sun Cover
 - P007032-1 : 1 x IP66 Mount Gasket (EPDM), for Flush/Console mount
- Please see user manual/datasheet for more information

Factory Options:

- Projected Capacitive Touch Screen (Multitouch, USB, Pen/Glove supported)
- Optical Bonding Technology
- Color Calibrated models (ECDIS)
- Sunlight Readable / High Bright (includes Optical Bonding)

APPROVALS & CERTIFICATES

These products have been tested / type approved by the following classification societies:

IEC 60945 4th (EN 60945:2002)

IACS E10

EU RO MR - Mutual Recognition (covers DNV, BV, ABS, GL, NK and LRS certificates)

Specifications - HD 24T22 MMD-xxx-FHxx

All specifications are subject to change without prior notice!

TFT Technology:

- LED Backlight Technology, TFT Active-matrix
- Sunlight Readable / High Bright (includes Optical Bonding Technology)
- 24.0 inch viewable image size, Widescreen, Aspect Ratio 16:9
- MVA (Multi-domain Vertical Alignment) LCD Technology, RGB vertical stripe

TFT Characteristics:

- Native Resolution : 1920 x 1080 (FHD)
- Pixel Pitch (RGB) : 0.276 (H) x 0.276 (V) mm
- Response Time : 25 ms (typical), "black" to "white"
- Contrast Ratio : 3000:1 (typical)
- Light Intensity : 1000 cd/m² (typical)
- Viewable Angle : +/- 89 deg. (typical) (Up/Down/Left/Right)
- Active Display Area : 531.36 (H) x 298.89 (V) mm
- Max Colors : 16.7 million

Synchronization:

- Digital separate synchronization
- Composite synchronization
- Synchronization on green
- Auto detects VGA -> WUXGA, interlaced and non interlaced
- Video Signal : Analog RGB 0,7Vp-p
- Input Impedance 75 Ohm

Synchronization Range:

- Horizontal : 31.5 kHz to 91.1 kHz
- Vertical : 60 Hz* to 85 Hz

* Recommended for optimal picture quality

Supported Signals:

Resolutions:

- VGA : 640 x 480 (including 640 x 350)
- SVGA : 800 x 600 (including 720 x 400)
- XGA : 1024 x 768
- SXGA : 1280 x 1024
- UXGA : 1600 x 1200
- FHD : 1920 x 1080*
- WUXGA : 1920 x 1200

* Recommended for optimal picture quality

Video Signals:

- Interlaced HDTV, NTSC, PAL and SECAM video
- Composite video

Power Specifications:

Multi-power Supply:

- 115&230VAC - 50/60Hz + 24 VDC

Note: You may connect either AC power or DC power or both. In case both sources are connected, power will be sourced from the AC input. If AC input is lost, there will be a uninterrupted switch-over to DC input.

Power Consumption:

- Operating AC/DC: TBDW (max)*

*Specified as delivered from factory. All additional loads for installed / connected equipment have to be added to power consumption and multiplied by 1.6 to compensate for efficiency in power converters.

Physical Considerations:

- W:593.00 [23.35"] x H:384.00 [15.12"] x D:77.00 [3.03"] mm [inch]
- Weight: 8.6kg / 18.9lbs
- Delivery includes an EPDM sealing gasket for IP66 console mount.

Signal Terminals:

- DVI-I IN : 2 x 29p DVI Female (or as VGA IN with adapter)*
- DP1.2 IN : 1 x 20p DisplayPort (female)
- Comp. Video IN : 2 x BNC Connector (female)
- SCOM RS-422/485 : 2 x 5-pin Terminal Block 3.81, non-isolated+Buzzer
- VGA OUT : 1 x 15p HD D-SUB (female) - Clone of VGA IN**
- SCOM+Touch : 1 x USB TYPE A Connector (female)
- Ethernet : 1 x RJ45 Connector for Remote Control
- SCOM RS-232 : 1 x 9p D-SUB (female) non-isolated+Buzzer
- Potmeter/User : 1 x 9p D-SUB (male)
(Potentiometer IN, +5VDC OUT, BRT +/- IN)
- AC Power IN : 1 x Std IEC Inlet
- DC Power IN : 1 x 2-pin Terminal Block 5.08

* DVI-I Port #1 as VGA IN also acts as clone to VGA Signal Out (buffered).

**Tested at recommended resolutions. The VGA output signal (buffered) is at same resolution and sync as the VGA input. The output is working even if the display unit is turned off, but power cable/supply must be connected/provided.

User Controls:

Behind front bezel - Glass Display Control™ (GDC) IP66:

- Power On/Off, On Screen Display Menu, Brightness Control (-/+)
- Hotkeys (left/right), Mode Status Indicators (ECDIS, Service)
- Buzzer (through glass), Light Sensor (behind glass)

Environmental Considerations:

- Operating : Temperature -15 deg. C to +55 deg. C
- Storage : Temperature -30 deg. C to +70 deg. C
- Humidity : Up to 95%
- IP Rating : Protection: IP66 front - IP22 rear (EN60529)
- Compass Safe Dist. : Standard: 140cm - Steering: 85cm

Lifetime Considerations:

Even although the test conditions for bridge units provide for a maximum operating temperature of 55°C, continuous operation of all electronic components should, if possible, take place at ambient temperatures of only 25°C. This is a necessary prerequisite for long life and low service costs.

Available Accessories:

- HD CMB SX2-E1 : 1 x Console Mount Kit. EN60945 Tested
 - HD TMB SX1-C1 : 1 x Table Mount Bracket. EN60945 Tested
 - HD VED SX2-H1 : 1 x VESA Adapter (75/75, 100/100 & 200/100mm)
Not EN60945 Tested
 - HD REM SX1-A1 : 1 x External Remote Control, EN60945 Tested
 - HD 24COV SX1-A1 : 1 x UV Sun Cover
 - P007032-1 : 1 x IP66 Mount Gasket (EPDM), for Flush/Console mount
- Please see user manual/datasheet for more information

Factory Options:

- Projected Capacitive Touch Screen (Multitouch, USB, Pen/Glove supported)
- Color Calibrated models (ECDIS)

APPROVALS & CERTIFICATES

These products have been tested / type approved by the following classification societies:

IEC 60945 4th (EN 60945:2002)

IACS E10

EU RO MR - Mutual Recognition (covers DNV, BV, ABS, GL, NK and LRS certificates)

Specifications - HD 26T22 MMD-xxx-Fxxx

All specifications are subject to change without prior notice!

TFT Technology:

- LED Backlight Technology, TFT Active-matrix
- 25.54 inch viewable image size, Widescreen, Aspect Ratio 16:10
- S-MVA (Multi-domain Vertical Alignment) Technology, RGB Vertical Stripe

TFT Characteristics:

- Native Resolution : 1920 x 1200
- Pixel Pitch (RGB) : 0.2865 (H) x 0.2865 (V) mm
- Response Time : 20ms (Tr+Tf)
- Contrast Ratio : 1500:1 (typical)
- Light Intensity : 350 cd/m² (typical)
- Viewable Angle : +/- 88 deg. (typical) (Up/Down/Left/Right)
- Active Display Area : 550.08 (H) x 343.8 (V) mm
- Max Colors : 16.7 million

Synchronization:

- Digital separate synchronization
- Composite synchronization
- Synchronization on green
- Auto detects VGA -> WUXGA, interlaced and non interlaced
- Video Signal : Analog RGB 0,7Vp-p
- Input Impedance 75 Ohm

Synchronization Range:

- Horizontal : 31.5 kHz to 91.1 kHz
- Vertical : 60 Hz* to 85 Hz

* Recommended for optimal picture quality

Supported Signals:

Resolutions:

- VGA : 640 x 480 (including 640 x 350)
- SVGA : 800 x 600 (including 720 x 400)
- XGA : 1024 x 768
- SXGA : 1280 x 1024
- UXGA : 1600 x 1200
- FHD : 1920 x 1080
- WUXGA : 1920 x 1200*

* Recommended for optimal picture quality

Video Signals:

- Interlaced HDTV, NTSC, PAL and SECAM video
- Composite video

Power Specifications:

Multi-power Supply:

- 115&230VAC - 50/60Hz + 24 VDC

Note: You may connect either AC power or DC power or both. In case both sources are connected, power will be sourced from the AC input. If AC input is lost, there will be a uninterrupted switch-over to DC input.

Power Consumption:

- Operating AC/DC: 59W (max)

Physical Considerations:

- W:621.00 [24.45"] x H:435.00 [17.13"] x D:92.20 [3.62"] mm [inch]
- Weight: Approx. 15.0kg / 33.0lbs

Signal Terminals:

- DVI-I IN : 2 x 29p DVI Female (or as VGA IN with adapter)*
- DP1.2 IN : 1 x 20p DisplayPort (female)
- Comp. Video IN : 2 x BNC Connector (female)
- SCOM RS-422/485 : 2 x 5-pin Terminal Block 3.81, non-isolated+Buzzer
- VGA OUT : 1 x 15p HD D-SUB (female) - Clone of VGA IN**
- SCOM+Touch : 1 x USB TYPE A Connector (female)
- Ethernet : 1 x RJ45 Connector for Remote Control
- SCOM RS-232 : 1 x 9p D-SUB (female) non-isolated+Buzzer
- Potmeter/User : 1 x 9p D-SUB (male)
(Potentiometer IN, +5VDC OUT, BRT +/- IN)
- AC Power IN : 1 x Std IEC Inlet
- DC Power IN : 1 x 2-pin Terminal Block 5.08

* DVI-I Port #1 as VGA IN also acts as clone to VGA Signal Out (buffered).

**Tested at recommended resolutions. The VGA output signal (buffered) is at same resolution and sync as the VGA input. The output is working even if the display unit is turned off, but power cable/supply must be connected/provided.

User Controls:

Behind front bezel - Glass Display Control™ (GDC) IP66:

- Power On/Off, On Screen Display Menu, Brightness Control (-/+)
- Hotkeys (left/right), Mode Status Indicators (ECDIS, Service)
- Buzzer (through glass), Light Sensor (behind glass)

Environmental Considerations:

- Operating : Temperature -15 deg. C to +55 deg. C
- Storage : Temperature -30 deg. C to +70 deg. C
- Humidity : Up to 95%
- IP Rating : Protection: IP66 front – IP22 rear (EN60529)
- Compass Safe Dist. : Standard: 190cm - Steering: 110cm

Lifetime Considerations:

Even although the test conditions for bridge units provide for a maximum operating temperature of 55°C, continuous operation of all electronic components should, if possible, take place at ambient temperatures of only 25°C. This is a necessary prerequisite for long life and low service costs.

Available Accessories:

- HD CMB SX2-F1 : 1 x Console Mount Kit. EN60945 Tested
 - HD TMB SX1-C1 : 1 x Table Mount Bracket. EN60945 Tested
 - HD VED SX2-H1 : 1 x VESA Adapter (75/75, 100/100 & 200/100mm)
Not EN60945 Tested
 - HD REM SX1-A1 : 1 x External Remote Control, EN60945 Tested
 - HD 26COV SX1-A1 : 1 x UV Sun Cover
 - JH 26TAP STD-A1 : 1 x Frame Adapter for Series 1 Cutout (retrofit)
 - P007178 : 1 x IP66 Mount Gasket (EPDM), for Flush/Console mount
- Please see user manual/datasheet for more information

Factory Options:

- Projected Capacitive Touch Screen (Multitouch, USB, Pen/Glove supported)
- Optical Bonding Technology
- Color Calibrated models (ECDIS)

APPROVALS & CERTIFICATES

These products have been tested / type approved by the following classification societies:

IEC 60945 4th (EN 60945:2002)

IACS E10

EU RO MR - Mutual Recognition (covers DNV, BV, ABS, GL, NK and LRS certificates)

Specifications - HD 27T22 MMD-xxx-Fxxx

All specifications are subject to change without prior notice!

TFT Technology:

- LED Backlight Technology, Color Active Matrix
- 27.0 inch viewable image size, Widescreen, Aspect Ratio 16:9
- a-SI (amorphous silicon) Thin Film Transistor (TFT)

TFT Characteristics:

- Native Resolution : 1920 x 1080 (FHD)
- Pixel Pitch (RGB) : 0.31125 (H) x 0.31125 (V) mm
- Response Time : 12 ms (typical) (on/off)
- Contrast Ratio : 3000:1 (typical)
- Light Intensity : 300 cd/m² (typical)
- Viewable Angle : +/- 89 deg. (typical) (Up/Down/Left/Right)
- Active Display Area : 597.6 (H) x 336.15 (V) mm
- Max Colors : 16.7 million

Synchronization:

- Digital separate synchronization
- Composite synchronization
- Synchronization on green
- Auto detects VGA -> FHD, interlaced and non interlaced
- Video Signal : Analog RGB 0,7Vp-p
- : Input Impedance 75 Ohm

Synchronization Range:

- Horizontal : 31.5 kHz to 91.1 kHz
- Vertical : 60 Hz* to 85 Hz

* Recommended for optimal picture quality

Supported Signals:

Resolutions:

- VGA : 640 x 480 (including 640 x 350)
- SVGA : 800 x 600 (including 720 x 400)
- XGA : 1024 x 768
- SXGA : 1280 x 1024
- UXGA : 1600 x 1200
- FHD : 1920 x 1080*

* Recommended for optimal picture quality

Video Signals:

- Interlaced HDTV, NTSC, PAL and SECAM video
- Composite video

Power Specifications:

Multi-power Supply:

- 115&230VAC - 50/60Hz + 24 VDC

Note: You may connect either AC power or DC power or both. In case both sources are connected, power will be sourced from the AC input. If AC input is lost, there will be a uninterrupted switch-over to DC input.

Power Consumption:

- Operating AC/DC: 44W (max)

Physical Considerations:

- W:650.00 [25.59"] x H:437.00 [17.20"] x D:69.50 [2.74"] mm [inch]
- Weight: Approx. 12.0kg / 26.4lbs

Signal Terminals:

- DVI-I IN : 2 x 29p DVI Female (or as VGA IN with adapter)*
- DP1.2 IN : 1 x 20p DisplayPort (female)
- Comp. Video IN : 2 x BNC Connector (female)
- SCOM RS-422/485 : 2 x 5-pin Terminal Block 3.81, non-isolated+Buzzer
- VGA OUT : 1 x 15p HD D-SUB (female) - Clone of VGA IN**
- SCOM+Touch : 1 x USB TYPE A Connector (female)
- Ethernet : 1 x RJ45 Connector for Remote Control
- SCOM RS-232 : 1 x 9p D-SUB (female) non-isolated+Buzzer
- Potmeter/User : 1 x 9p D-SUB (male)
(Potentiometer IN, +5VDC OUT, BRT +/- IN)
- AC Power IN : 1 x Std IEC Inlet
- DC Power IN : 1 x 2-pin Terminal Block 5.08

* DVI-I Port #1 as VGA IN also acts as clone to VGA Signal Out (buffered).

**Tested at recommended resolutions. The VGA output signal (buffered) is at same resolution and sync as the VGA input. The output is working even if the display unit is turned off, but power cable/supply must be connected/provided.

User Controls:

Behind front bezel - Glass Display Control™ (GDC) IP66:

- Power On/Off, On Screen Display Menu, Brightness Control (-/+)
- Hotkeys (left/right), Mode Status Indicators (ECDIS, Service)
- Buzzer (through glass), Light Sensor (behind glass)

Environmental Considerations:

- Operating : Temperature -15 deg. C to +55 deg. C
- Storage : Temperature -30 deg. C to +70 deg. C
- Humidity : Up to 95%
- IP Rating : Protection: IP66 front – IP22 rear (EN60529)
- Compass Safe Dist. : Standard: 190cm - Steering: 110cm

Lifetime Considerations:

Even although the test conditions for bridge units provide for a maximum operating temperature of 55°C, continuous operation of all electronic components should, if possible, take place at ambient temperatures of only 25°C. This is a necessary prerequisite for long life and low service costs.

Available Accessories:

- HD CMB SX2-E1 : 1 x Console Mount Kit. EN60945 Tested
 - HD TMB SX1-C1 : 1 x Table Mount Bracket. EN60945 Tested
 - HD VED SX2-H1 : 1 x VESA Adapter (75/75, 100/100 & 200/100mm)
Not EN60945 Tested
 - HD REM SX1-A1 : 1 x External Remote Control, EN60945 Tested
 - HD 27COV SX1-A1 : 1 x UV Sun Cover
 - P018743 : 1 x IP66 Mount Gasket (EPDM), for Flush/Console mount
- Please see user manual/datasheet for more information

Factory Options:

- Projected Capacitive Touch Screen (Multitouch, USB, Pen/Glove supported)
- Optical Bonding Technology
- Color Calibrated models (ECDIS)

APPROVALS & CERTIFICATES

These products have been tested / type approved by the following classification societies:

IEC 60945 4th (EN 60945:2002)

IACS E10

EU RO MR - Mutual Recognition (covers DNV, BV, ABS, GL, NK and LRS certificates)

This page left intentionally blank



Technical Drawings

Technical Drawings - HD 15T22 MMD-xxx-Fxxx

Dimensions might be shown with or without decimals and indicated as mm [inches]. Tolerance on drawings is +/- 1mm. For accurate measurements, check relevant DWG file.

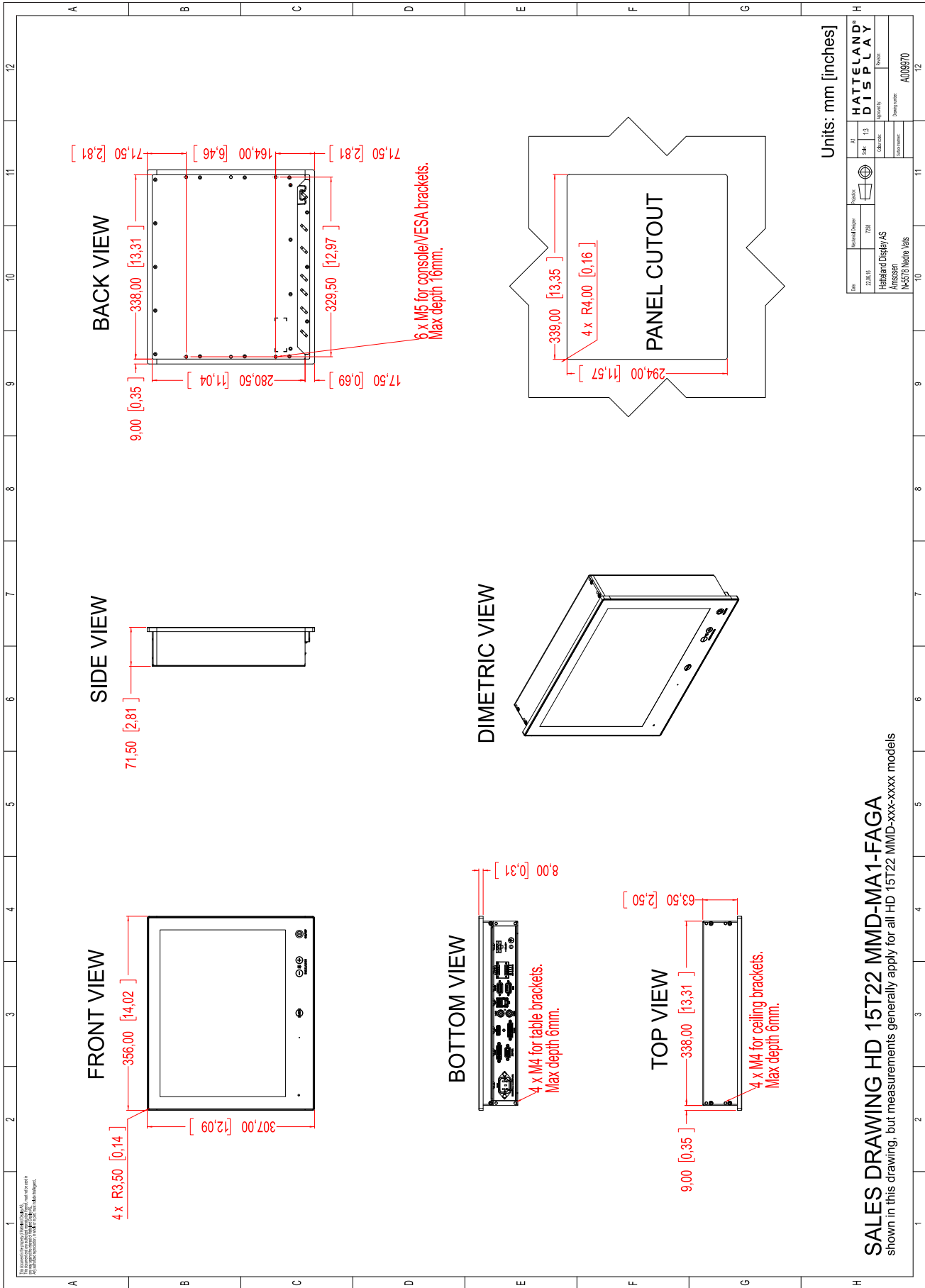

SALES DRAWING HD 15T22 MMD-MA1-FAGA
 shown in this drawing, but measurements generally apply for all HD 15T22 MMD-xxx-xxxx models

This document is the property of Hatteland Display AS. This document and any authorized reproduction thereof, must not be used in any way against the interest of Hatteland Display AS. Any authorized reproduction, in whole or in part, must include this legend. Hatteland Display Proprietary information. Not to be distributed to any third party without written permission.

Technical Drawings - HD 15T22 MMD-xxx-FHxx

Dimensions might be shown with or without decimals and indicated as mm [inches]. Tolerance on drawings is +/- 1mm. For accurate measurements, check relevant DWG file.

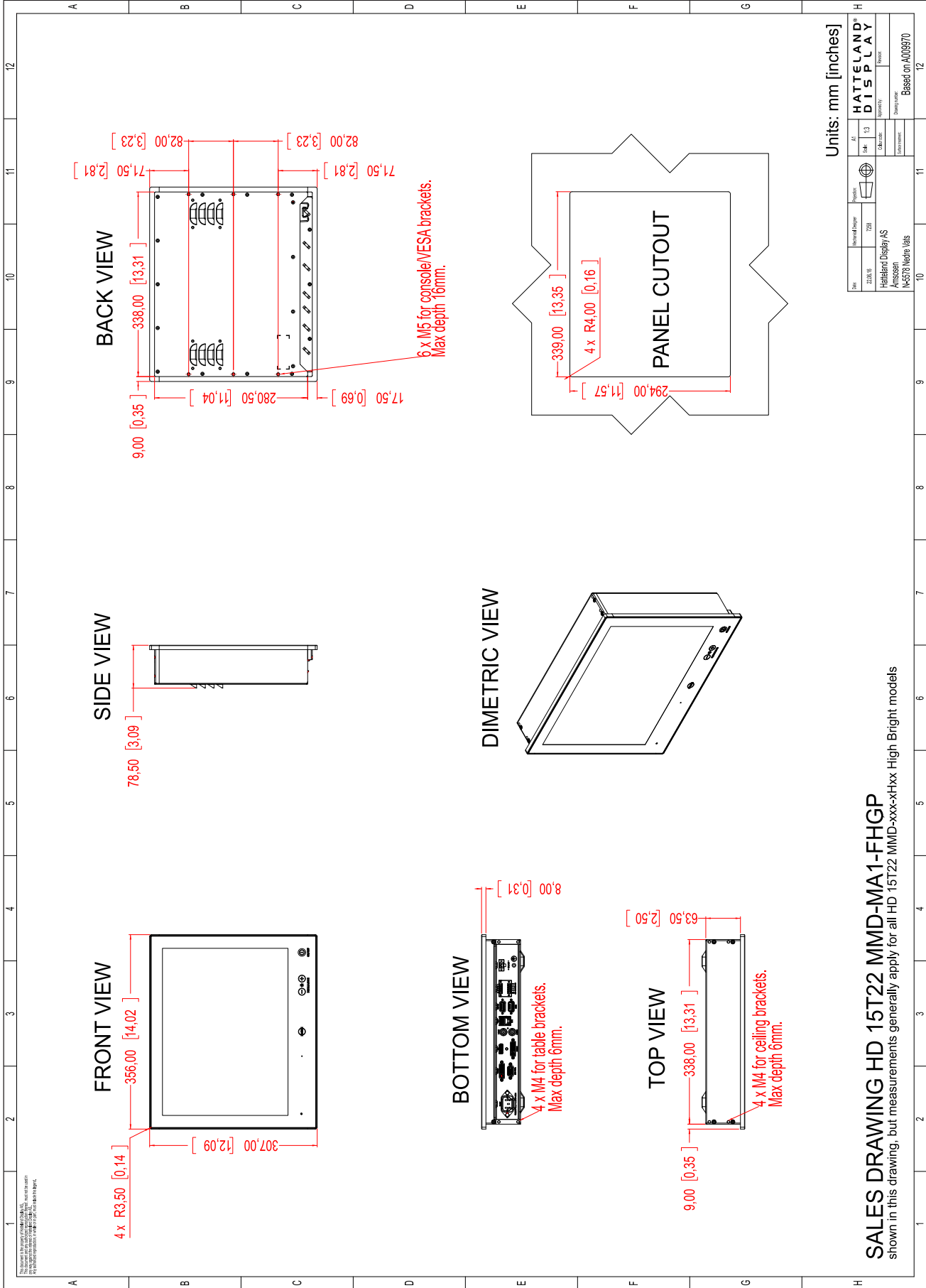

SALES DRAWING HD 15T22 MMD-MA1-FHGP
 shown in this drawing, but measurements generally apply for all HD 15T22 MMD-xxx-xHxx High Bright models

This document is the property of Hatteland Display AS. This document and any authorized reproduction thereof, must not be used in any way against the interest of Hatteland Display AS. Any authorized reproduction, in whole or in part, must include this legend. Hatteland Display Proprietary information. Not to be distributed to any third party without written permission.

Technical Drawings - HD 17T22 MMD-xxx-Fxxx

Dimensions might be shown with or without decimals and indicated as mm [inches]. Tolerance on drawings is +/- 1mm. For accurate measurements, check relevant DWG file.

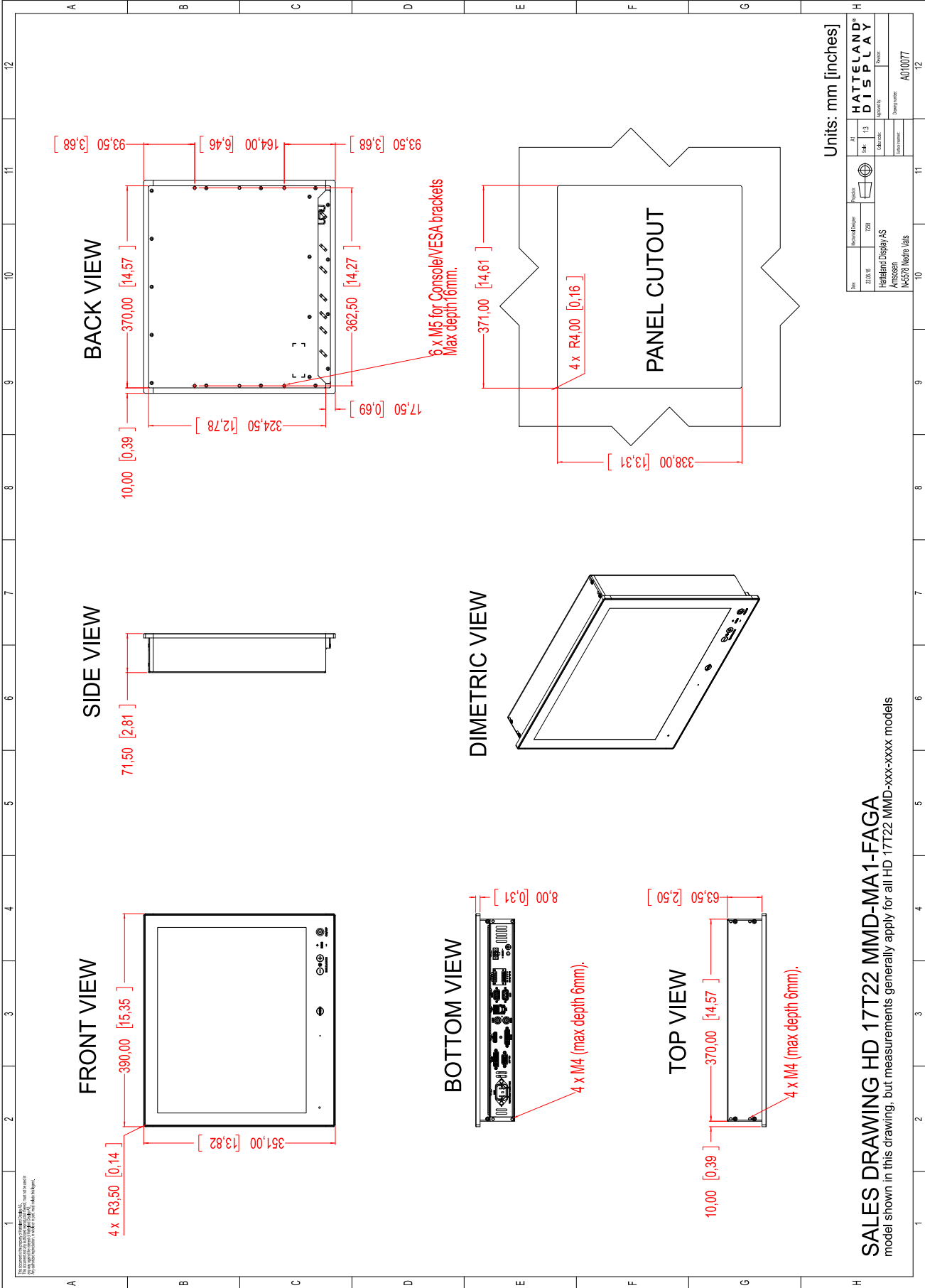

SALES DRAWING HD 17T22 MMD-MA1-FAGA
 model shown in this drawing, but measurements generally apply for all HD 17T22 MMD-xxx-xxxx models

This document is the property of Hatteland Display AS. This document and any authorized reproduction thereof, must not be used in any way against the interest of Hatteland Display AS. Any authorized reproduction, in whole or in part, must include this legend. Hatteland Display Proprietary information. Not to be distributed to any third party without written permission.

Technical Drawings - HD 17T22 MMD-xxx-FHxx

Dimensions might be shown with or without decimals and indicated as mm [inches]. Tolerance on drawings is +/- 1mm. For accurate measurements, check relevant DWG file.

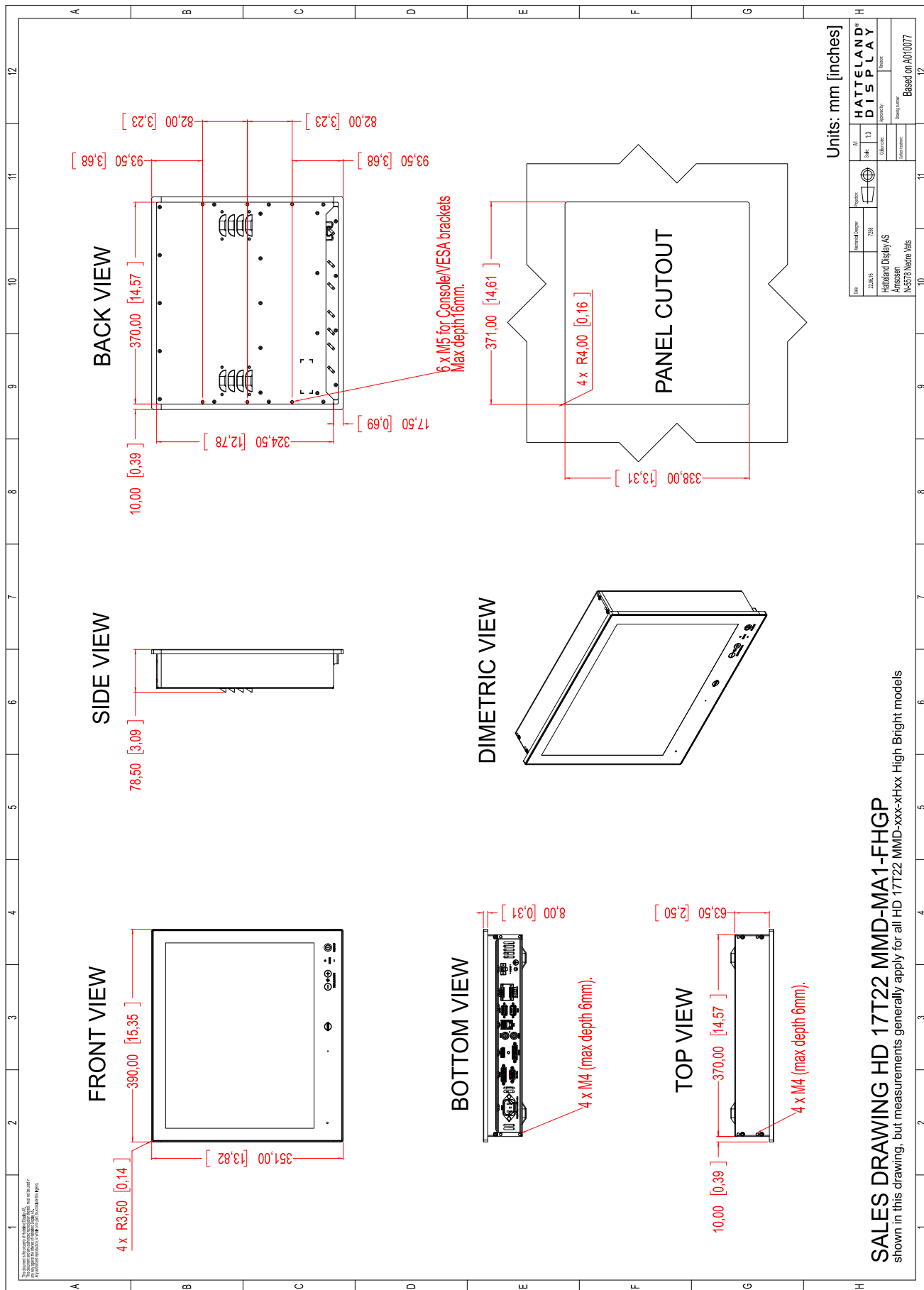

SALES DRAWING HD 17T22 MMD-MA1-FHGP
 shown in this drawing, but measurements generally apply for all HD 17T22 MMD-xxx-xHxx High Bright models

This document is the property of Hatteland Display AS. This document and any authorized reproduction thereof, must not be used in any way against the interest of Hatteland Display AS. Any authorized reproduction, in whole or in part, must include this legend. Hatteland Display Proprietary information. Not to be distributed to any third party without written permission.

Technical Drawings - HD 19T22 MMD-xxx-Fxxx

Dimensions might be shown with or without decimals and indicated as mm [inches]. Tolerance on drawings is +/- 1mm. For accurate measurements, check relevant DWG file.

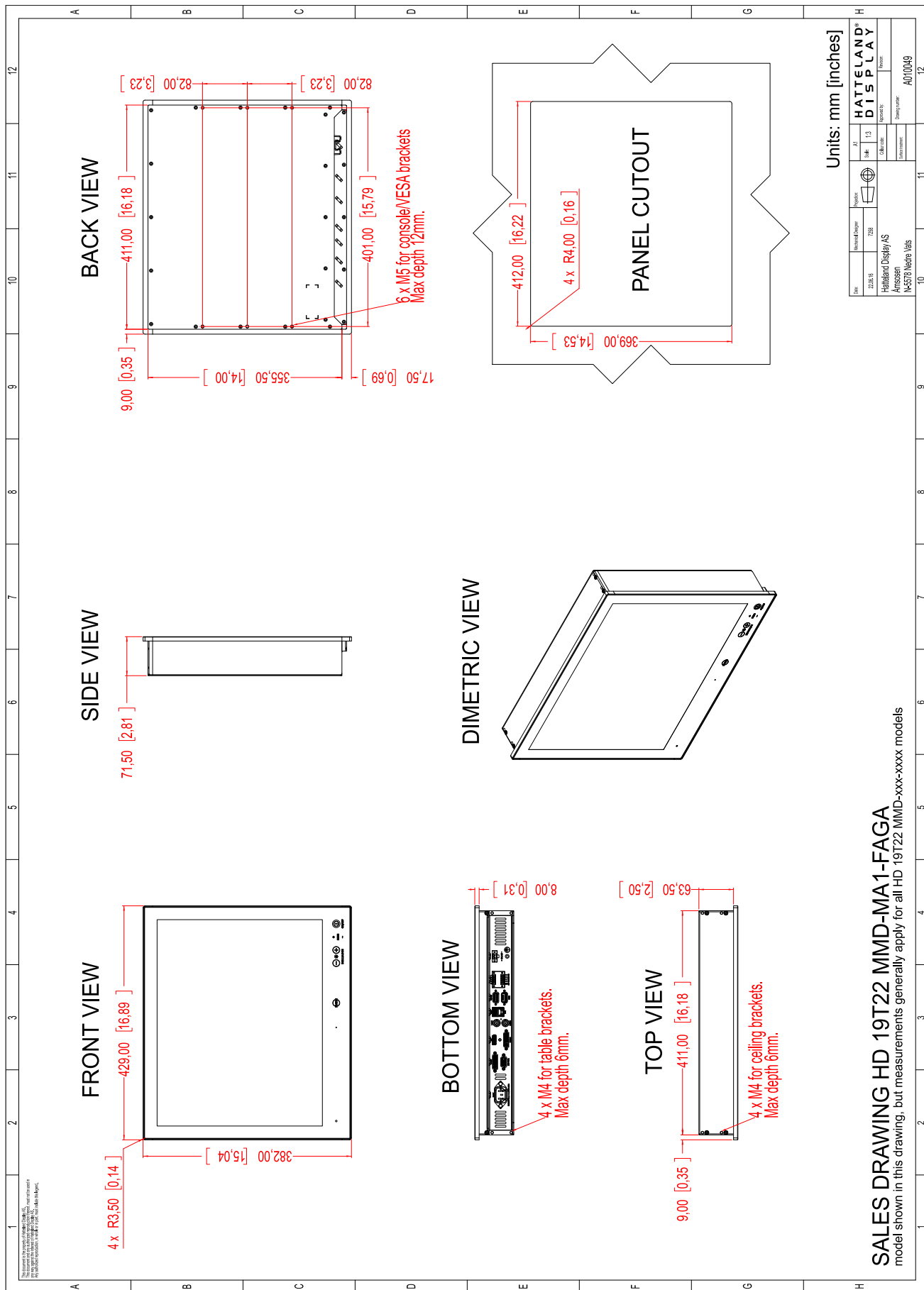

SALES DRAWING HD 19T22 MMD-MA1-FAGA
 model shown in this drawing, but measurements generally apply for all HD 19T22 MMD-xxx-xxxx models

This document is the property of Hatteland Display AS. This document and any authorized reproduction thereof, must not be used in any way against the interest of Hatteland Display AS. Any authorized reproduction, in whole or in part, must include this legend. Hatteland Display Proprietary information. Not to be distributed to any third party without written permission.

Technical Drawings - HD 19T22 MMD-xxx-FHxx

Dimensions might be shown with or without decimals and indicated as mm [inches]. Tolerance on drawings is +/- 1mm. For accurate measurements, check relevant DWG file.

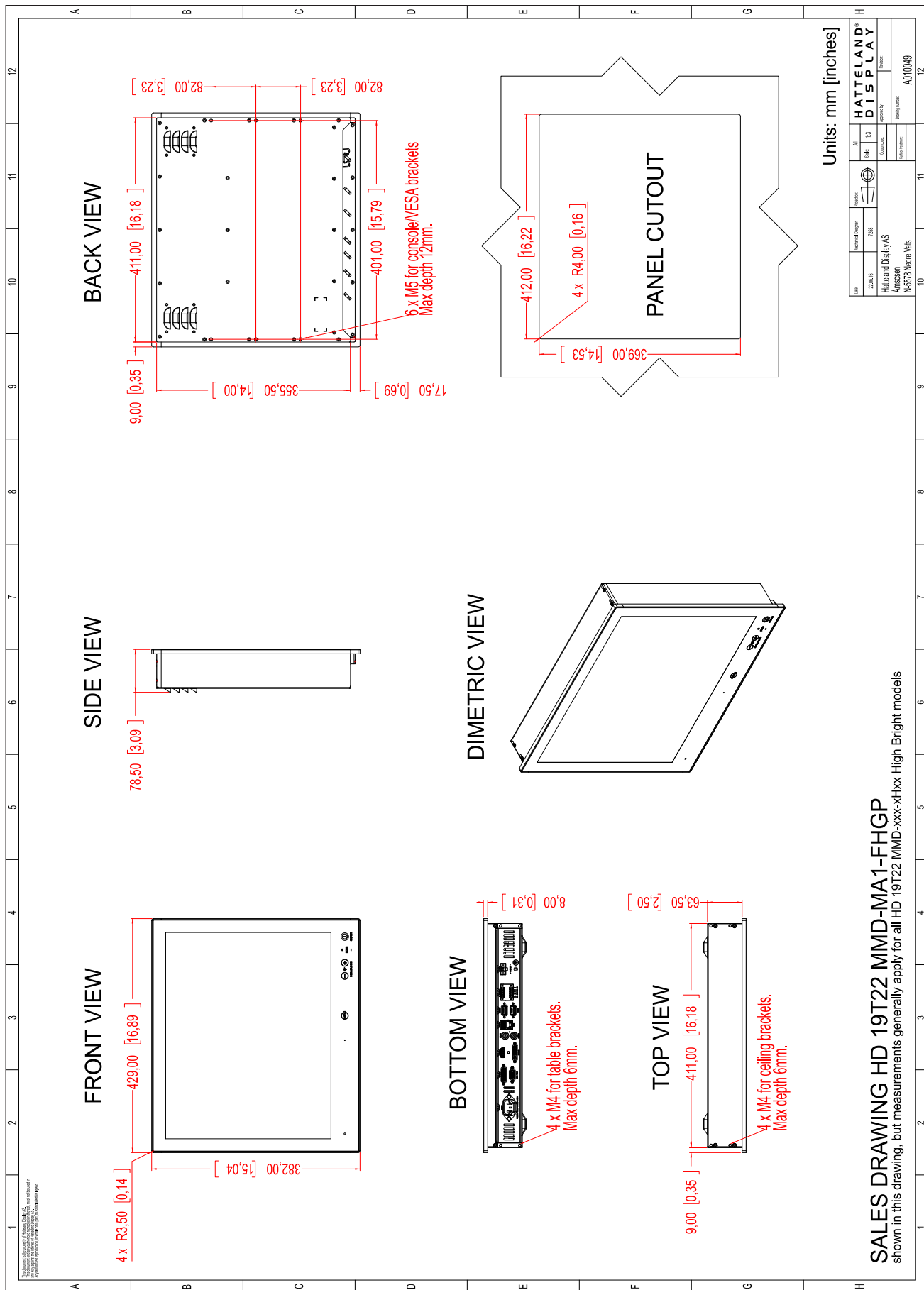

SALES DRAWING HD 19T22 MMD-MA1-FHGP
 shown in this drawing, but measurements generally apply for all HD 19T22 MMD-xxx-xHxx High Bright models

This document is the property of Hatteland Display AS. This document and any authorized reproduction thereof, must not be used in any way against the interest of Hatteland Display AS. Any authorized reproduction, in whole or in part, must include this legend. Hatteland Display Proprietary information. Not to be distributed to any third party without written permission.

Technical Drawings - HD 24T22 MMD-xxx-Fxxx

Dimensions might be shown with or without decimals and indicated as mm [inches]. Tolerance on drawings is +/- 1mm. For accurate measurements, check relevant DWG file.

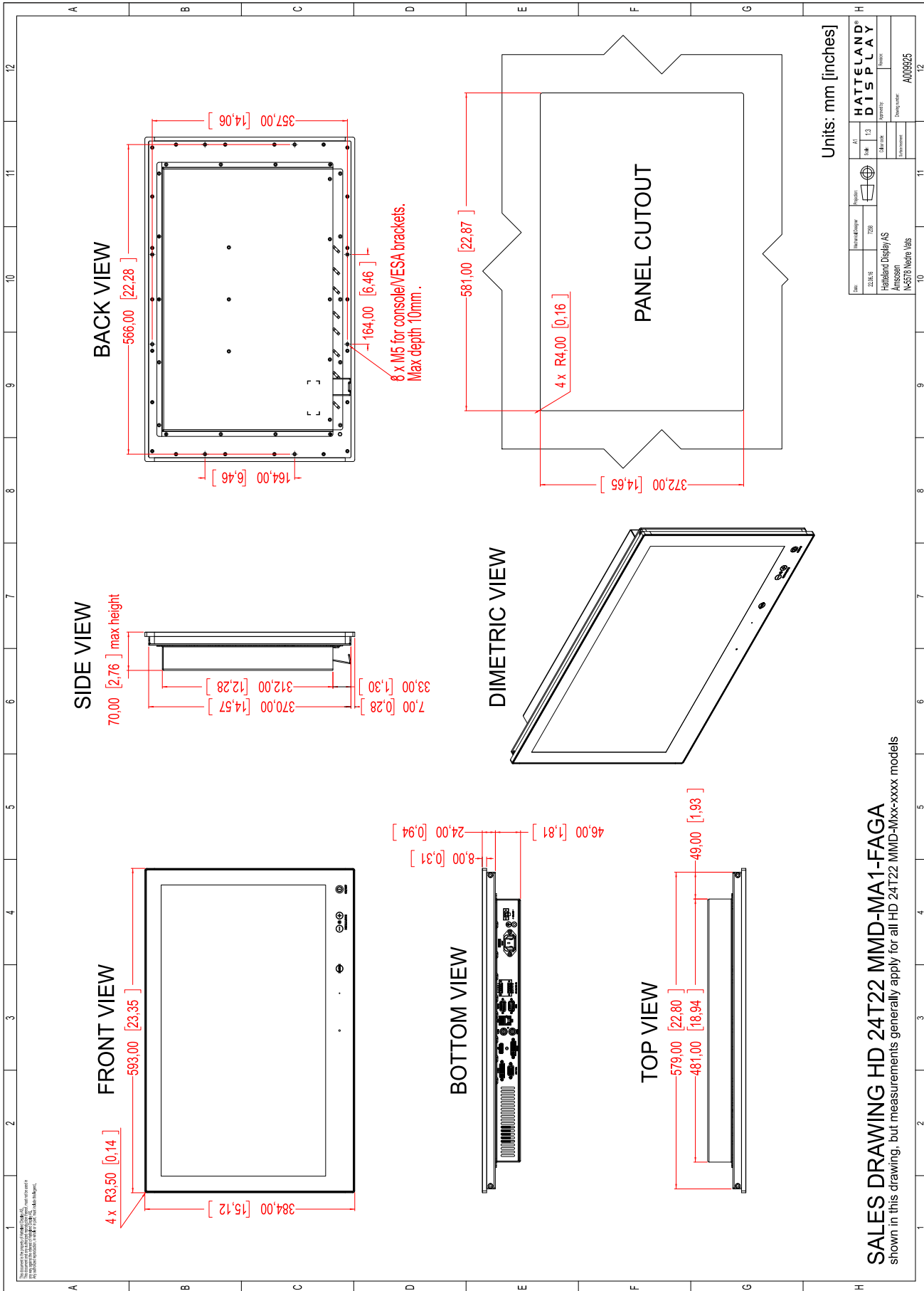

SALES DRAWING HD 24T22 MMD-MA1-FAGA
 shown in this drawing, but measurements generally apply for all HD 24T22 MMD-Mxx-xxxx models

This document is the property of Hatteland Display AS. This document and any authorized reproduction thereof, must not be used in any way against the interest of Hatteland Display AS. Any authorized reproduction, in whole or in part, must include this legend. Hatteland Display Proprietary information. Not to be distributed to any third party without written permission.

Technical Drawings - HD 24T22 MMD-xxx-FHxx

Dimensions might be shown with or without decimals and indicated as mm [inches]. Tolerance on drawings is +/- 1mm. For accurate measurements, check relevant DWG file.

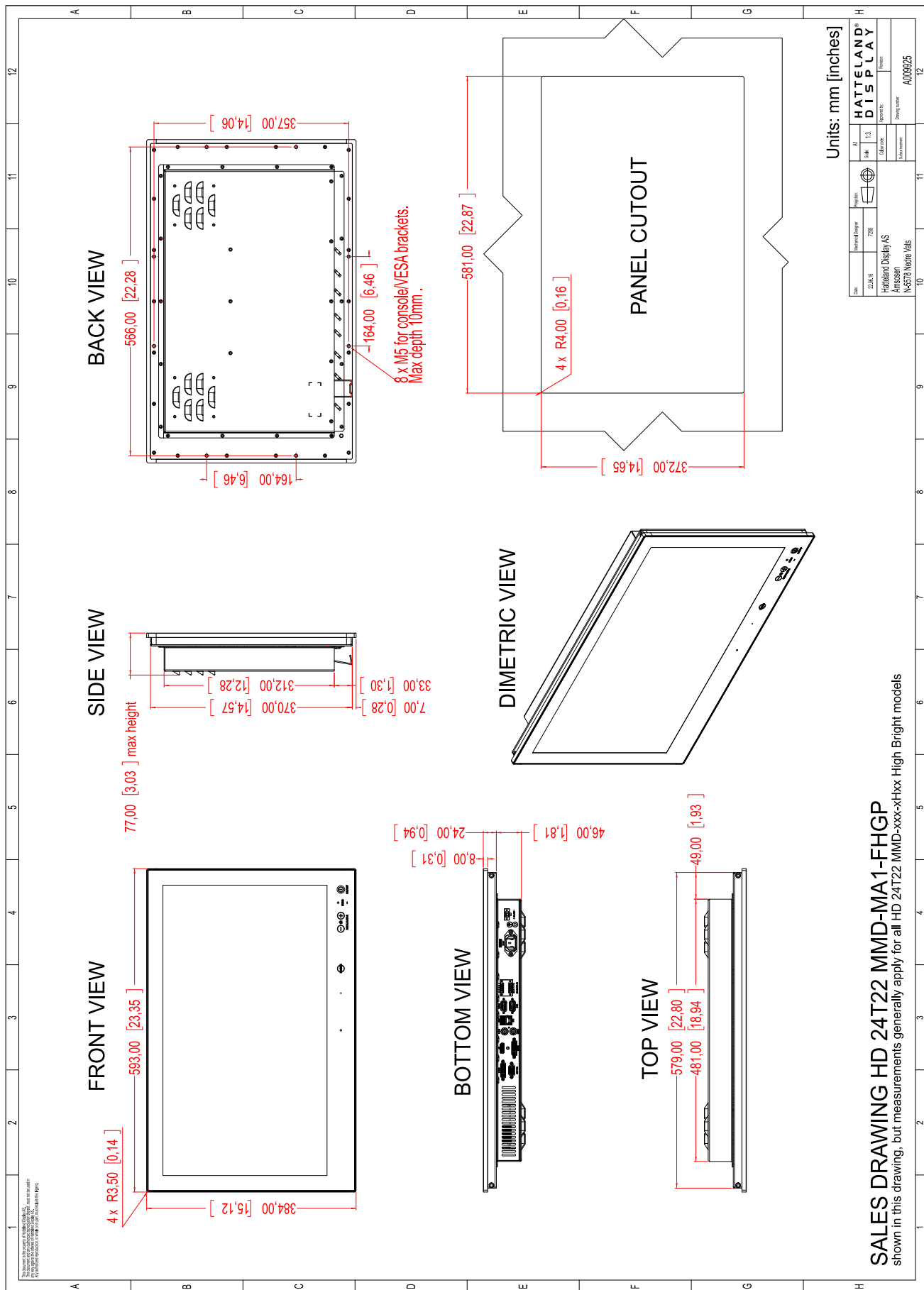

SALES DRAWING HD 24T22 MMD-MA1-FHGP
 shown in this drawing, but measurements generally apply for all HD 24T22 MMD-xxx-xhxx High Bright models

This document is the property of Hatteland Display AS. This document and any authorized reproduction thereof, must not be used in any way against the interest of Hatteland Display AS. Any authorized reproduction, in whole or in part, must include this legend. Hatteland Display Proprietary information. Not to be distributed to any third party without written permission.

Technical Drawings - HD 26T22 MMD-xxx-Fxxx

Dimensions might be shown with or without decimals and indicated as mm [inches]. Tolerance on drawings is +/- 1mm. For accurate measurements, check relevant DWG file.

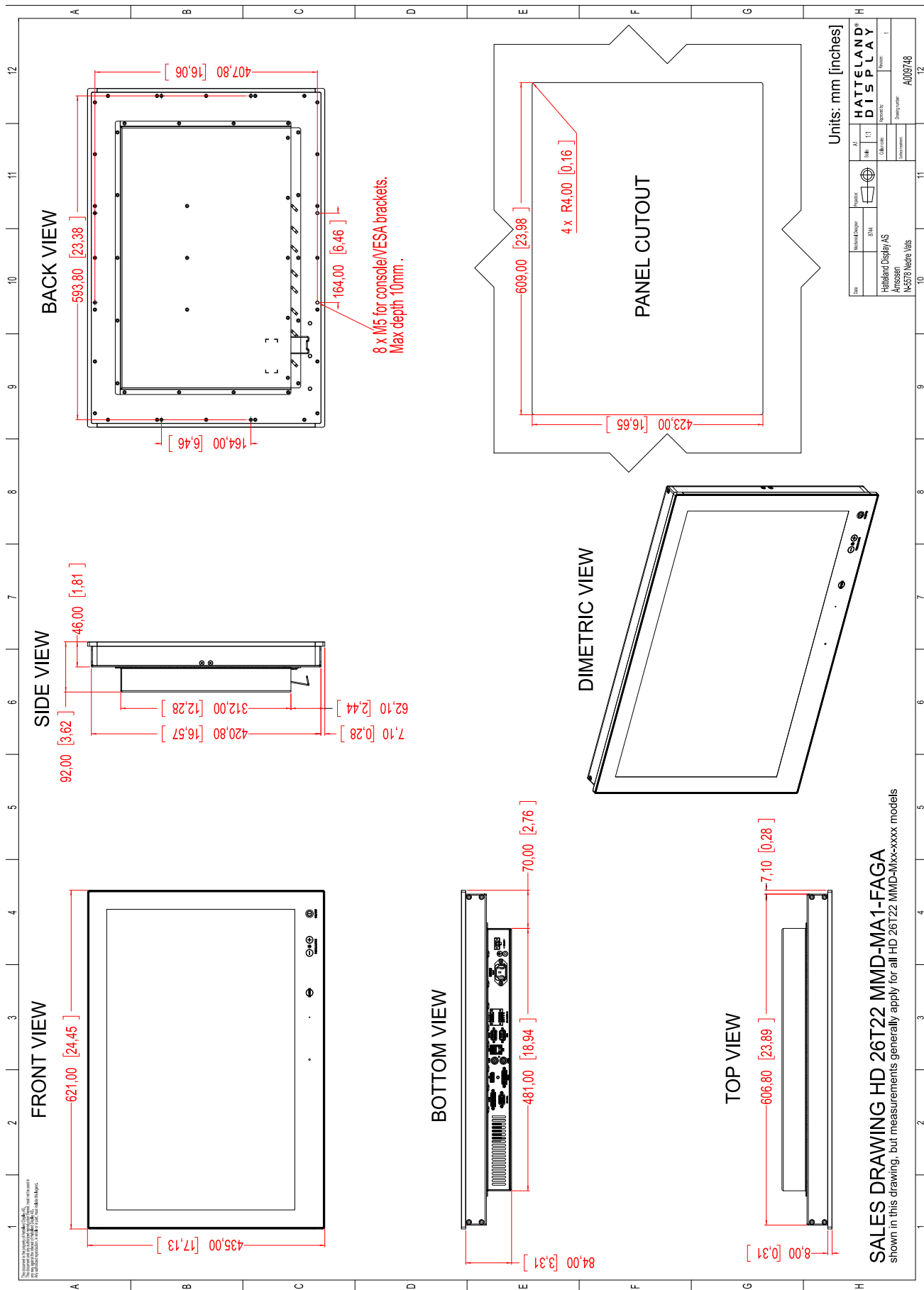

This document is the property of Hatteland Display AS. This document and any authorized reproduction thereof, must not be used in any way against the interest of Hatteland Display AS. Any authorized reproduction, in whole or in part, must include this legend. Hatteland Display Proprietary information. Not to be distributed to any third party without written permission.

Technical Drawings - HD 27T22 MMD-xxx-Fxxx

Dimensions might be shown with or without decimals and indicated as mm [inches]. Tolerance on drawings is +/- 1mm. For accurate measurements, check relevant DWG file.

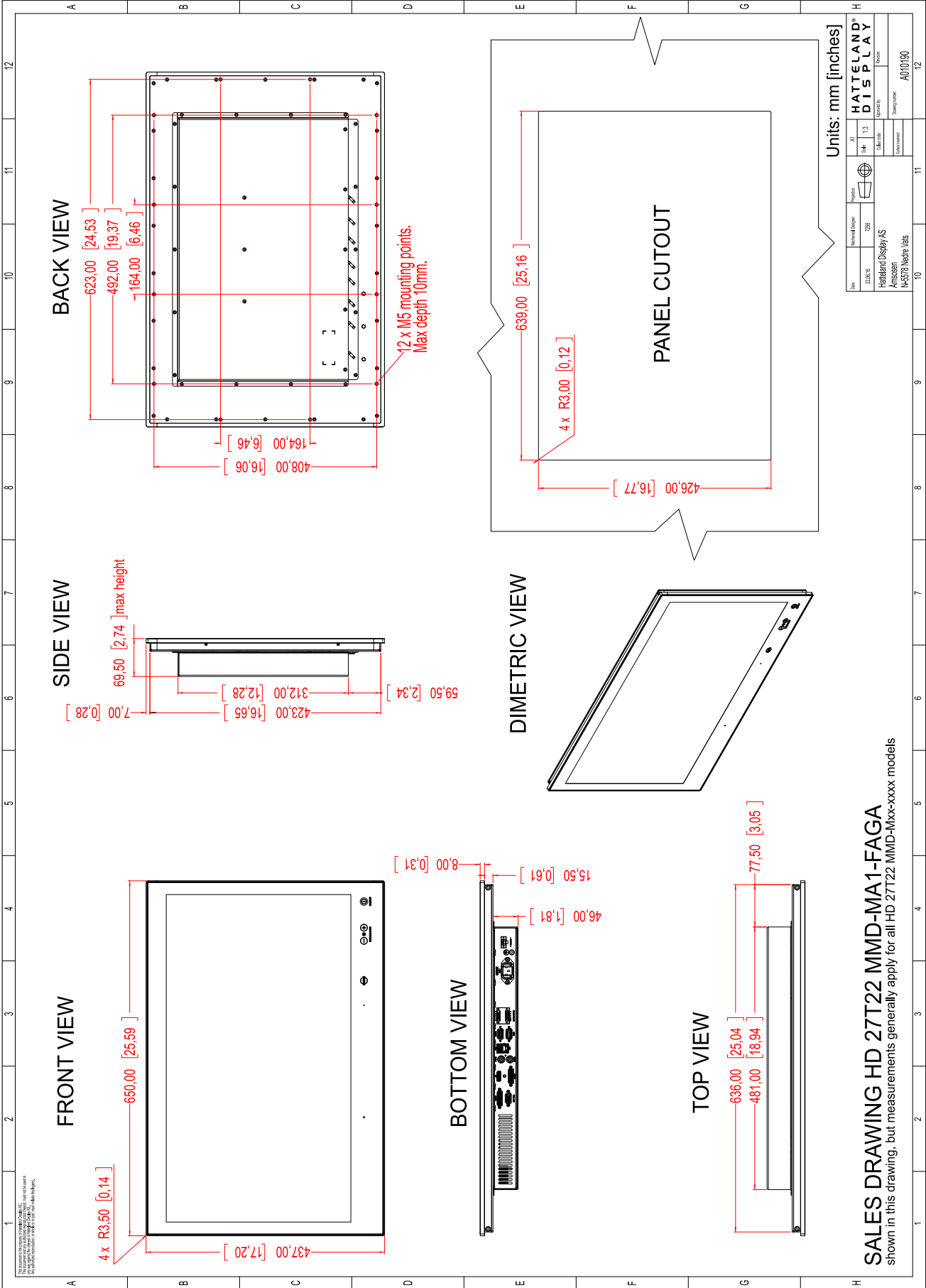

SALES DRAWING HD 27T22 MMD-MA1-FAGA
 shown in this drawing, but measurements generally apply for all HD 27T22 MMD-Mxx-xxxx models

This document is the property of Hatteland Display AS. This document and any authorized reproduction thereof, must not be used in any way against the interest of Hatteland Display AS. Any authorized reproduction, in whole or in part, must include this legend. Hatteland Display Proprietary information. Not to be distributed to any third party without written permission.

This page left intentionally blank



Technical Drawings - Accessories

Technical Drawings - HD TMB SX2-A1

Dimensions might be shown with or without decimals and indicated as mm [inches]. Tolerance on drawings is +/- 1mm. For accurate measurements, check relevant DWG file.

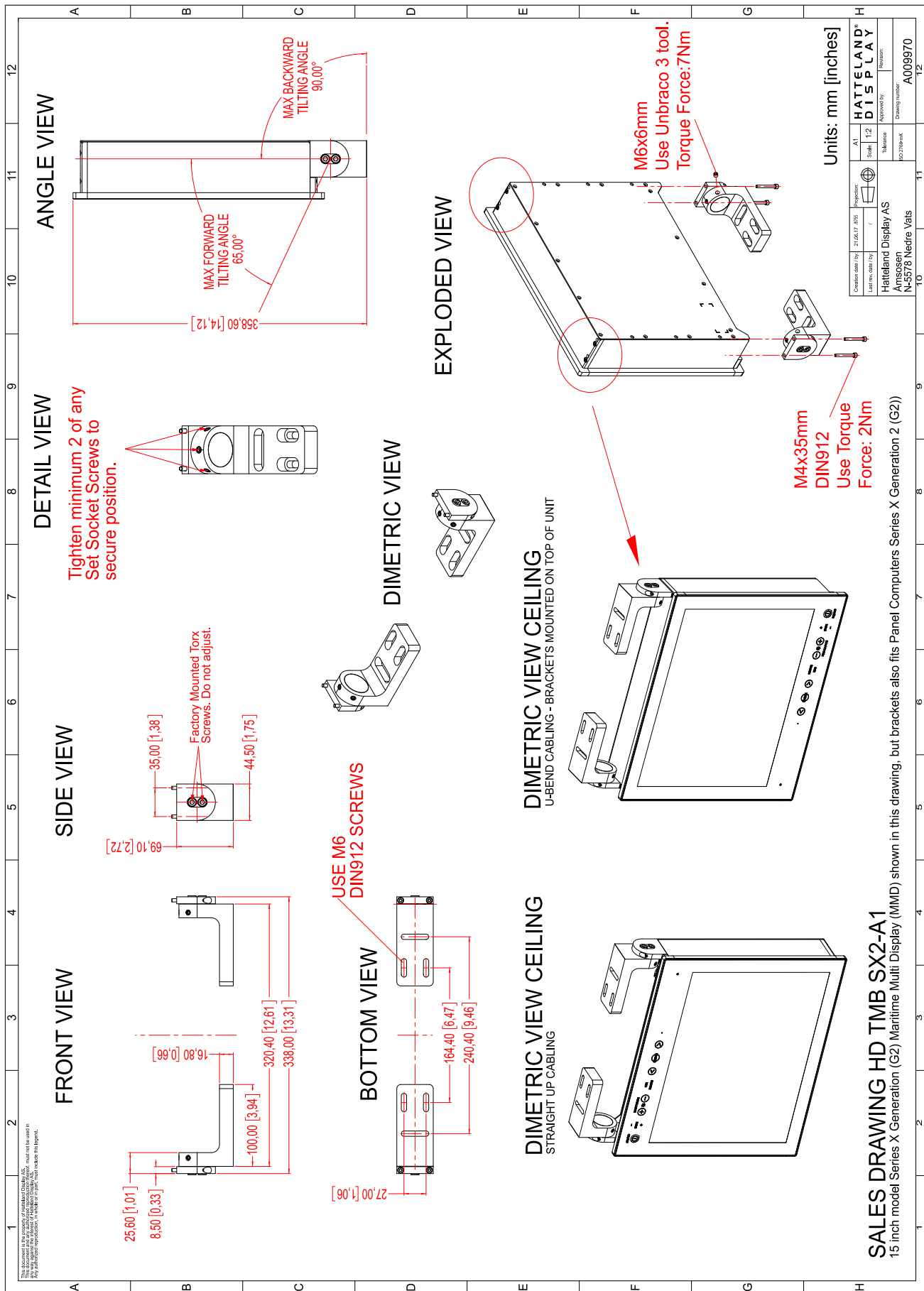

This document is the property of Hatteland Display AS. This document and any authorized reproduction thereof, must not be used in any way against the interest of Hatteland Display AS. Any authorized reproduction, in whole or in part, must include this legend. Hatteland Display Proprietary information. Not to be distributed to any third party without written permission.

Technical Drawings - HD TMB SX2-A1

Dimensions might be shown with or without decimals and indicated as mm [inches]. Tolerance on drawings is +/- 1mm. For accurate measurements, check relevant DWG file.

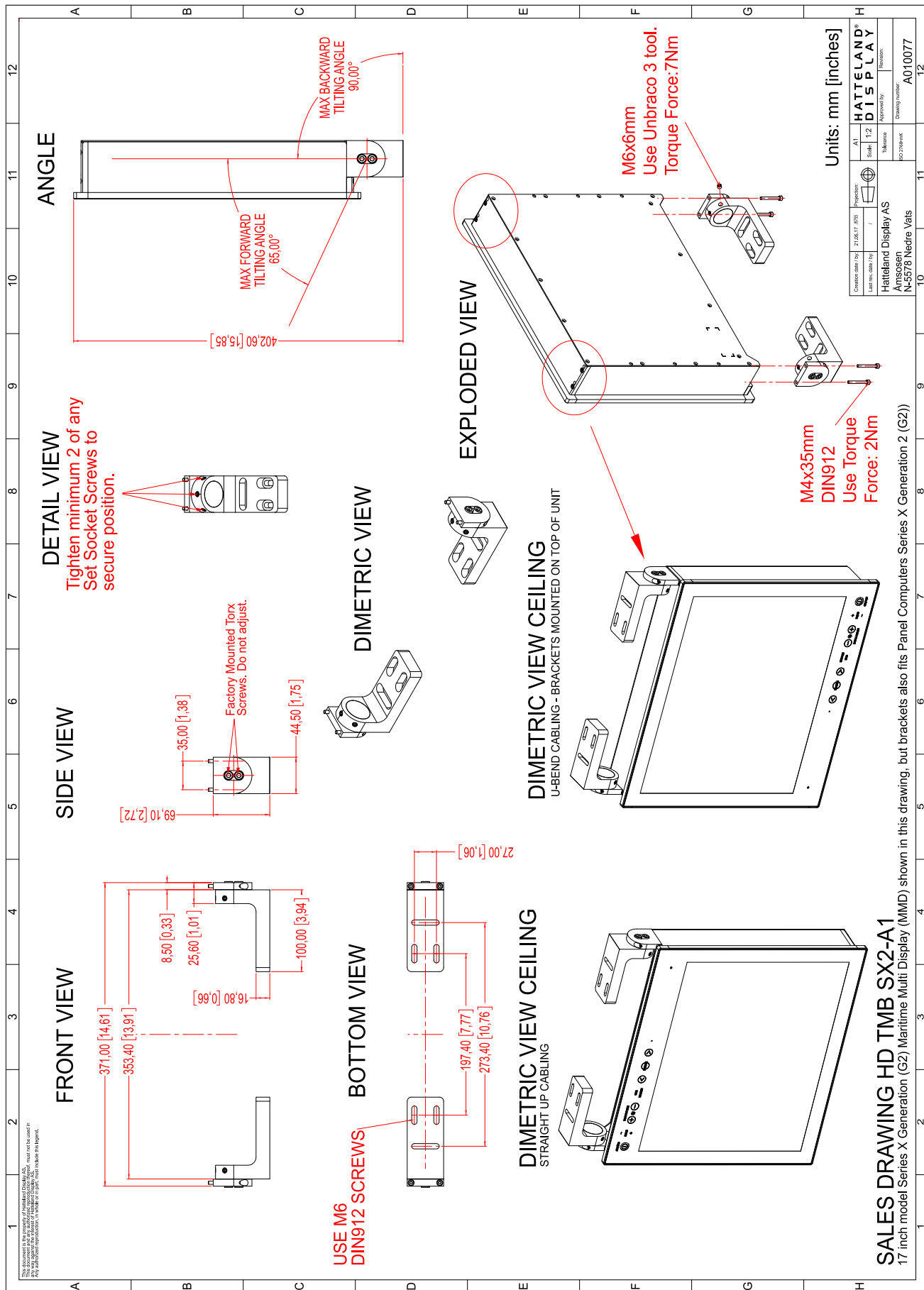

This document is the property of Hatteland Display AS. This document and any authorized reproduction thereof, must not be used in any way against the interest of Hatteland Display AS. Any authorized reproduction, in whole or in part, must include this legend. Hatteland Display Proprietary information. Not to be distributed to any third party without written permission.

Technical Drawings - HD TMB SX2-A1

Dimensions might be shown with or without decimals and indicated as mm [inches]. Tolerance on drawings is +/- 1mm. For accurate measurements, check relevant DWG file.

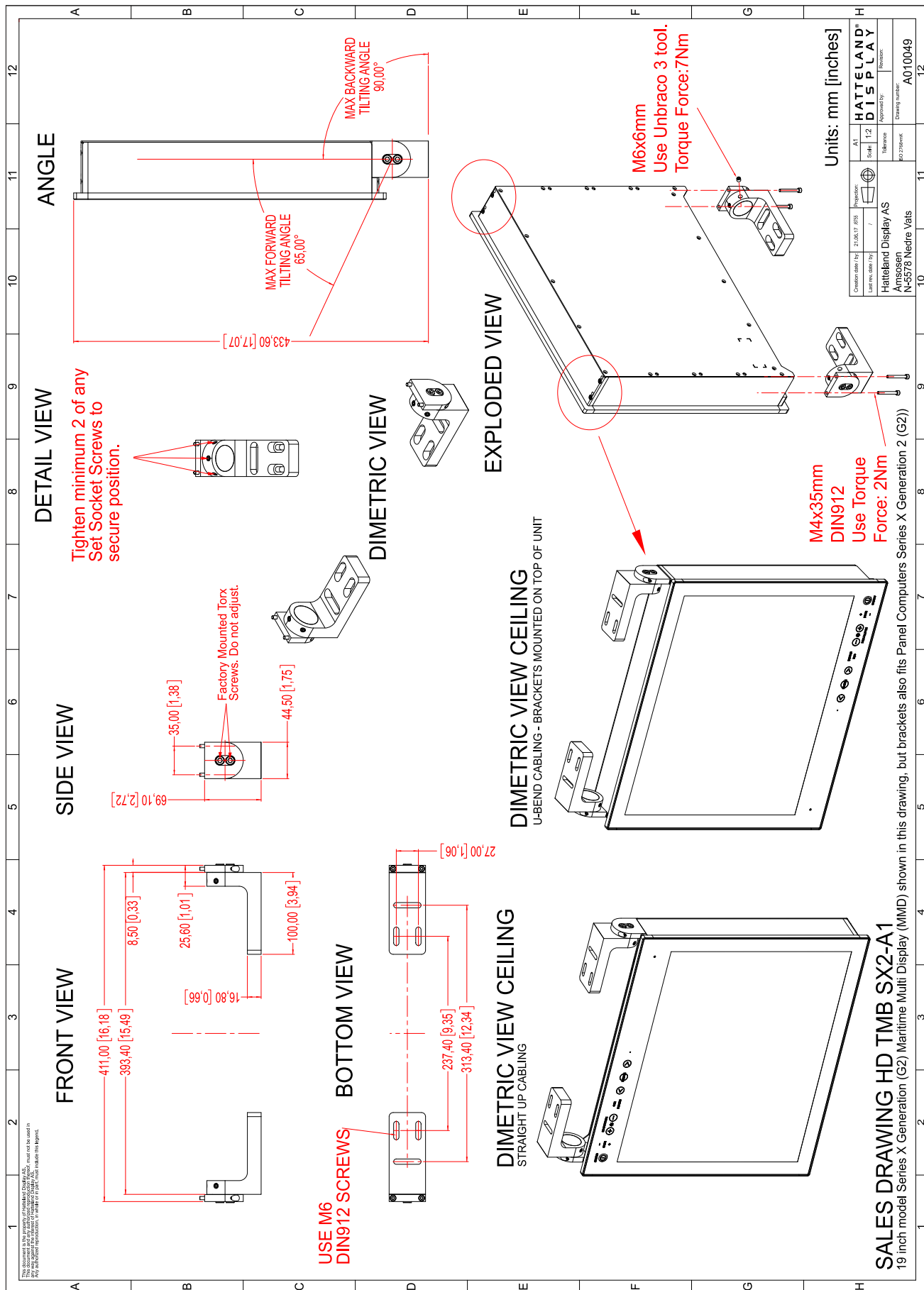

This document is the property of Hatteland Display AS. This document and any authorized reproduction thereof, must not be used in any way against the interest of Hatteland Display AS. Any authorized reproduction, in whole or in part, must include this legend. Hatteland Display Proprietary information. Not to be distributed to any third party without written permission.

Technical Drawings - HD TMB SX1-C1

Dimensions might be shown with or without decimals and indicated as mm [inches]. Tolerance on drawings is +/- 1mm. For accurate measurements, check relevant DWG file.

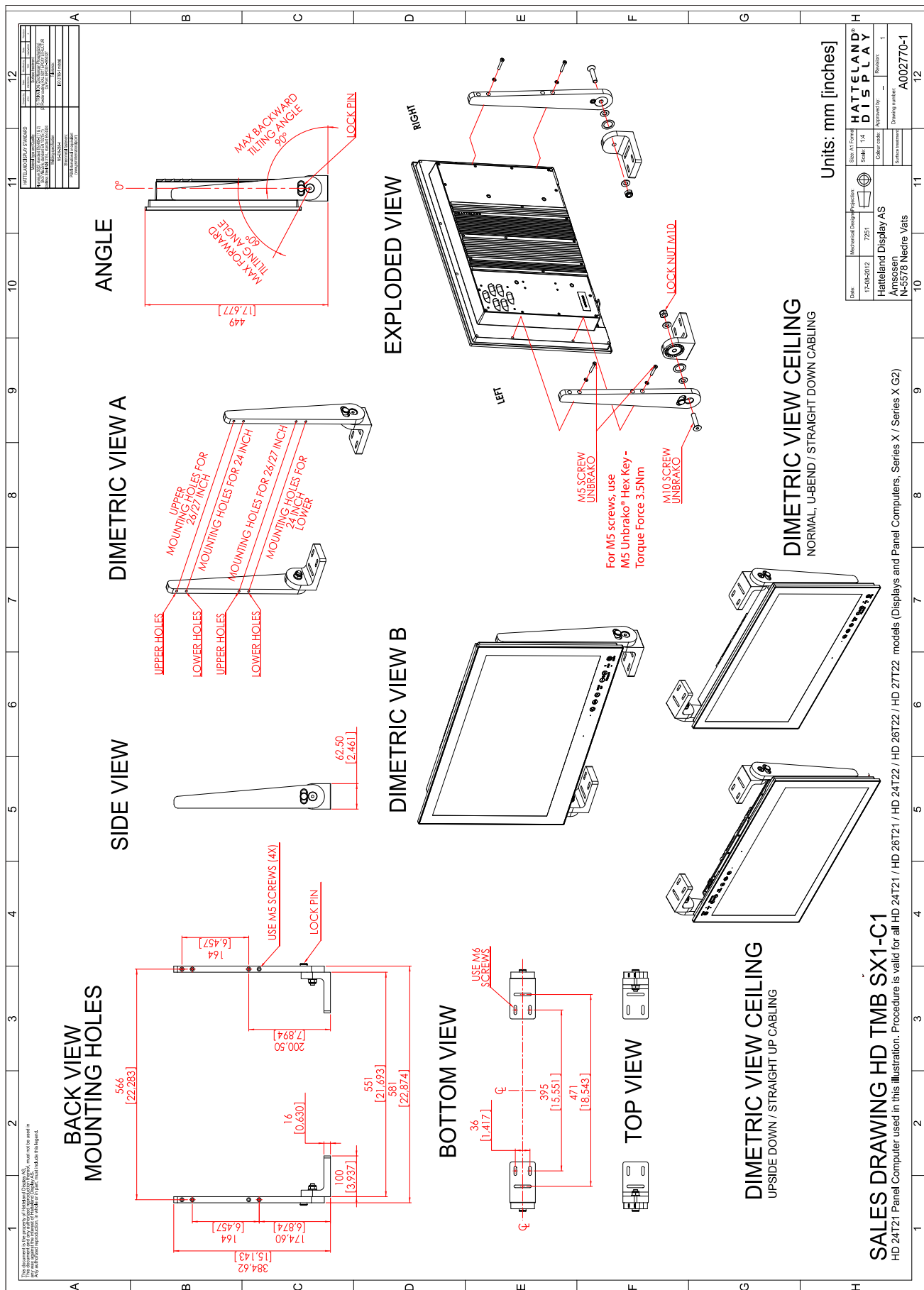

This document is the property of Hatteland Display AS. This document and any authorized reproduction thereof, must not be used in any way against the interest of Hatteland Display AS. Any authorized reproduction, in whole or in part, must include this legend. Hatteland Display Proprietary information. Not to be distributed to any third party without written permission.

Technical Drawings - HD CMB SX2-A1

Dimensions might be shown with or without decimals and indicated as mm [inches]. Tolerance on drawings is +/- 1mm. For accurate measurements, check relevant DWG file.

This document is the property of Hatteland Display AS.
This document and any authorized reproduction thereof, must not be used in
any way without the prior written permission of Hatteland Display AS.
Any unauthorized reproduction, in whole or in part, must include this legend.

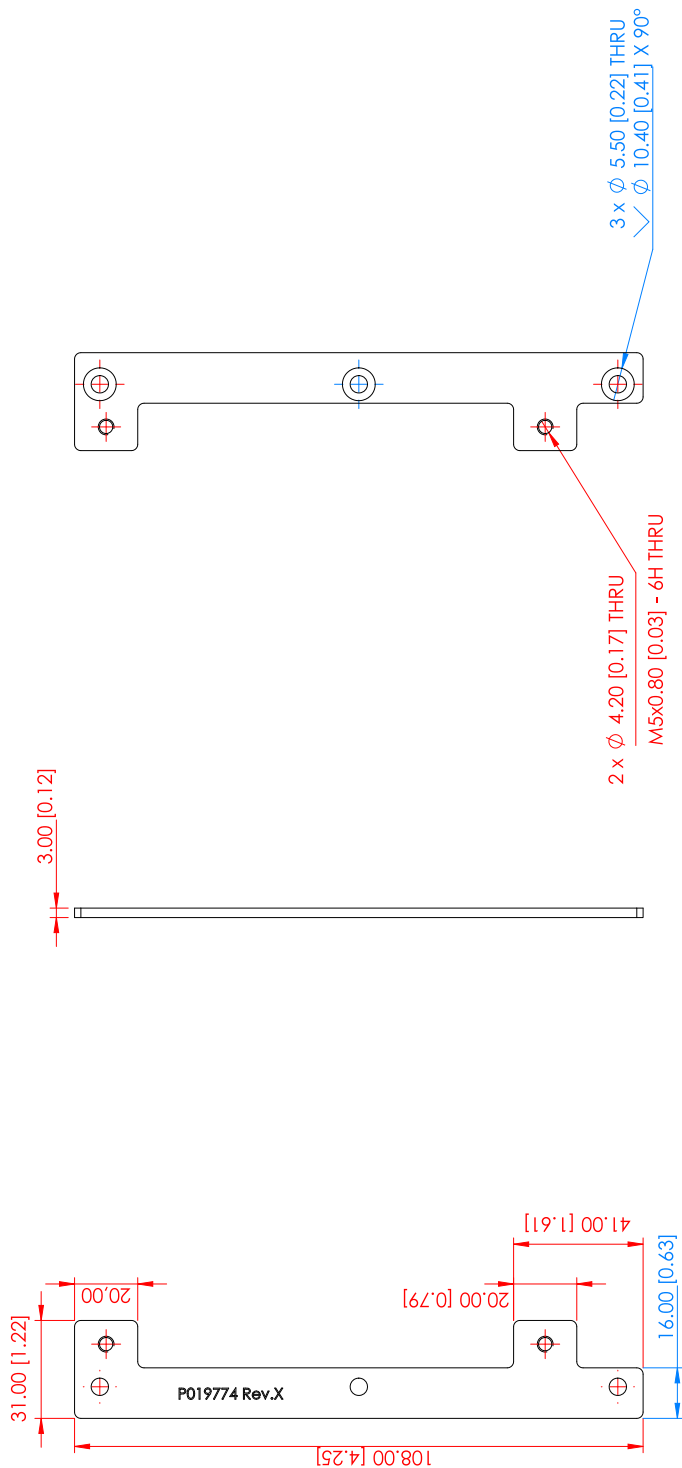

Units: mm [inches]

Description		Material	
xxT22 Console Bracket		AISI 304	
HATTELAND® DISPLAY			
Creation date / by:	24.11/16 7258	Projection:	A4
Last rev. date / by:	/	Scale:	1:2
Hatteland Display AS		Sheet	1 / 1
Stokkastrandvegen 87B		Tolerance	Welding specification
N-5578 Nedre Vats		ISO 2768-1 middel	NS-EN-288-4
		Colour code:	Approved by: 8744
			Revision: 02
		Drawing number: P019774	

SALES DRAWING HD CMB SX2-A1
Console Mount Bracket for 15, 17 and 19 inch Series X G2 MMC/MMD

This document is the property of Hatteland Display AS. This document and any authorized reproduction thereof, must not be used in any way against the interest of Hatteland Display AS. Any authorized reproduction, in whole or in part, must include this legend. Hatteland Display Proprietary information. Not to be distributed to any third party without written permission.

Technical Drawings - HD CMB SX2-A1

Dimensions might be shown with or without decimals and indicated as mm [inches]. Tolerance on drawings is +/- 1mm. For accurate measurements, check relevant DWG file.

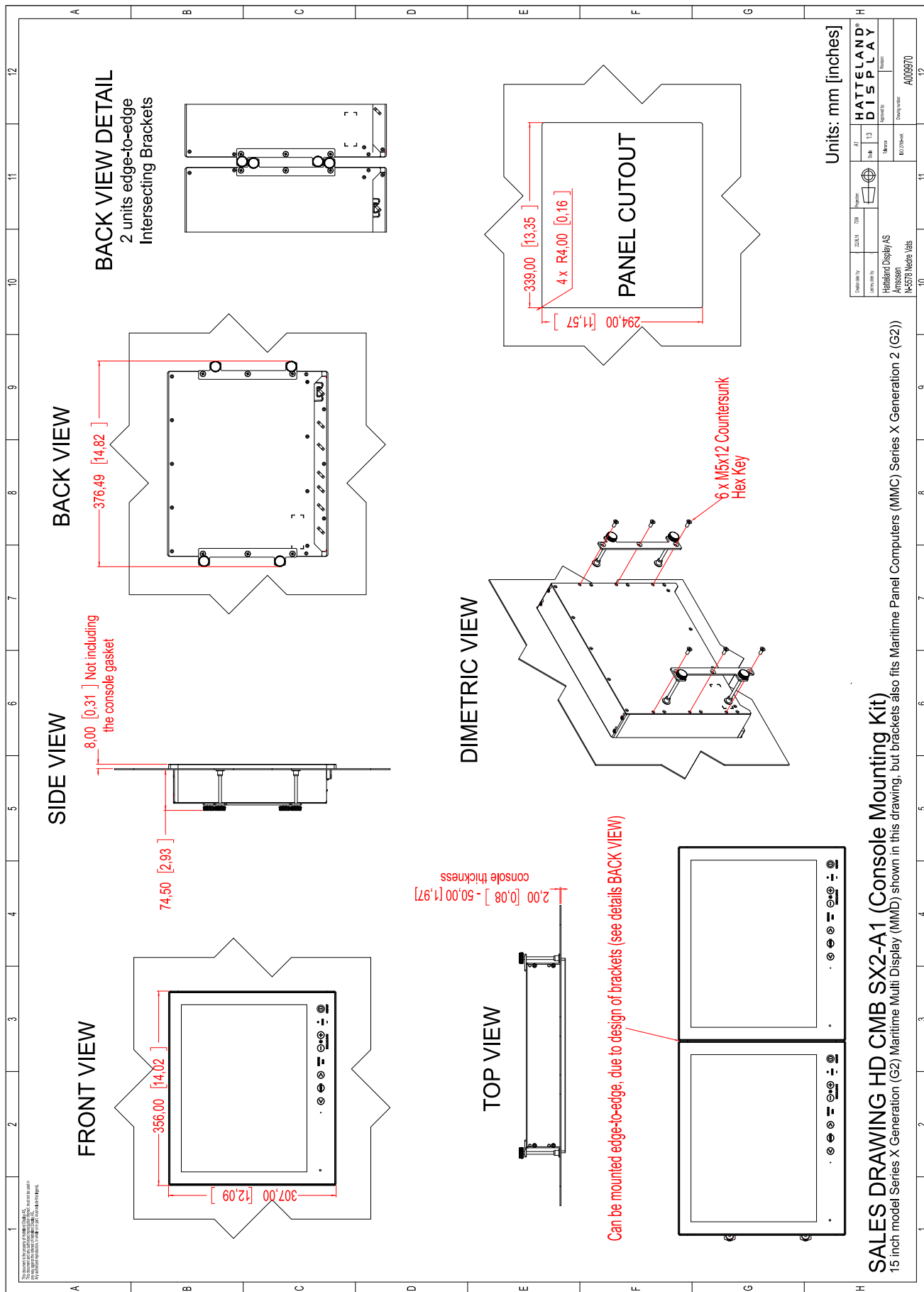

SALES DRAWING HD CMB SX2-A1 (Console Mounting Kit)
 15 inch model Series X Generation (G2) Maritime Multi Display (MMD) shown in this drawing, but brackets also fits Maritime Panel Computers (MMC) Series X Generation 2 (G2)

This document is the property of Hatteland Display AS. This document and any authorized reproduction thereof, must not be used in any way against the interest of Hatteland Display AS. Any authorized reproduction, in whole or in part, must include this legend. Hatteland Display Proprietary information. Not to be distributed to any third party without written permission.

Technical Drawings - HD CMB SX2-A1

Dimensions might be shown with or without decimals and indicated as mm [inches]. Tolerance on drawings is +/- 1mm. For accurate measurements, check relevant DWG file.

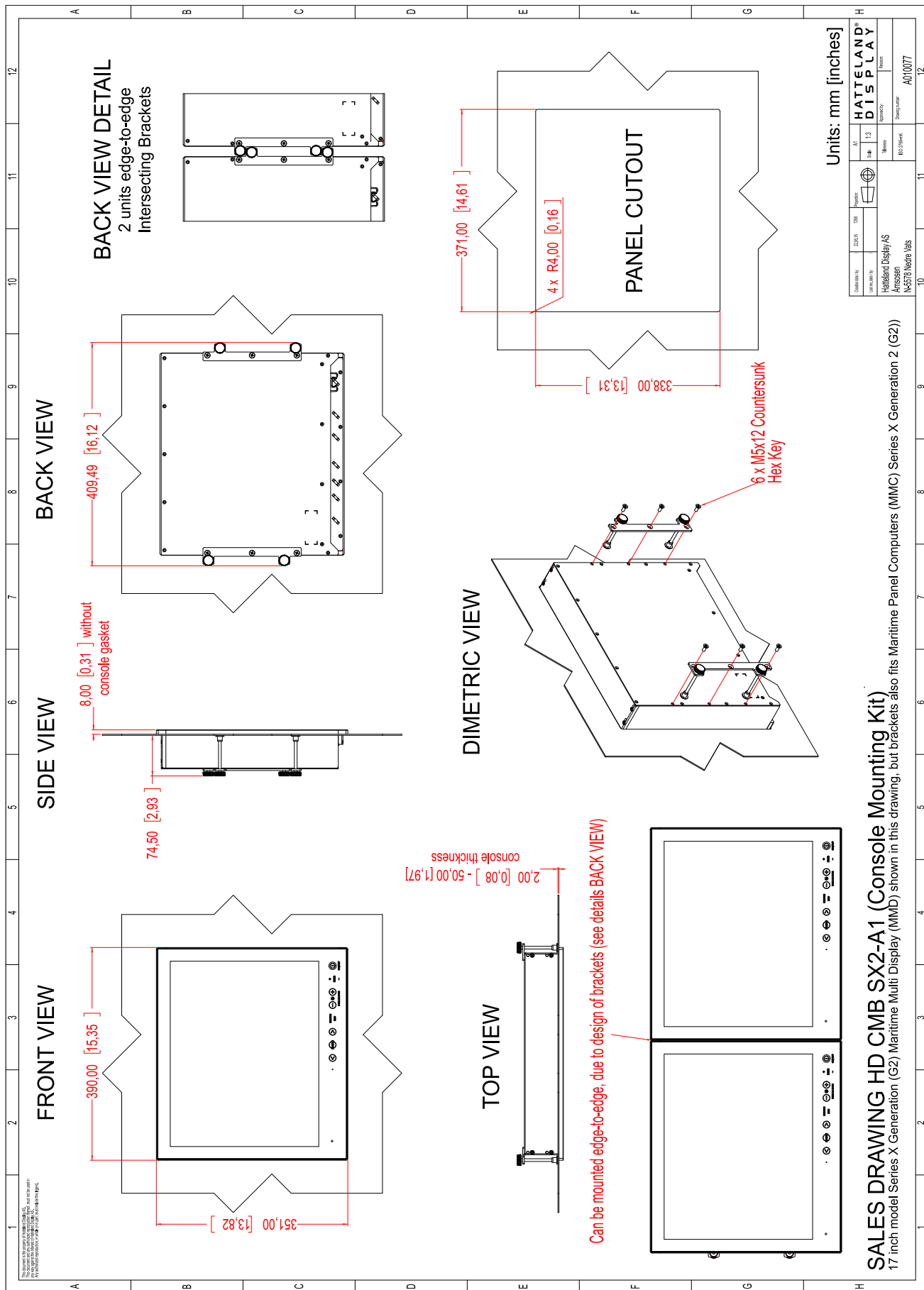

This document is the property of Hatteland Display AS. This document and any authorized reproduction thereof, must not be used in any way against the interest of Hatteland Display AS. Any authorized reproduction, in whole or in part, must include this legend. Hatteland Display Proprietary information. Not to be distributed to any third party without written permission.

Technical Drawings - HD CMB SX2-A1

Dimensions might be shown with or without decimals and indicated as mm [inches]. Tolerance on drawings is +/- 1mm. For accurate measurements, check relevant DWG file.

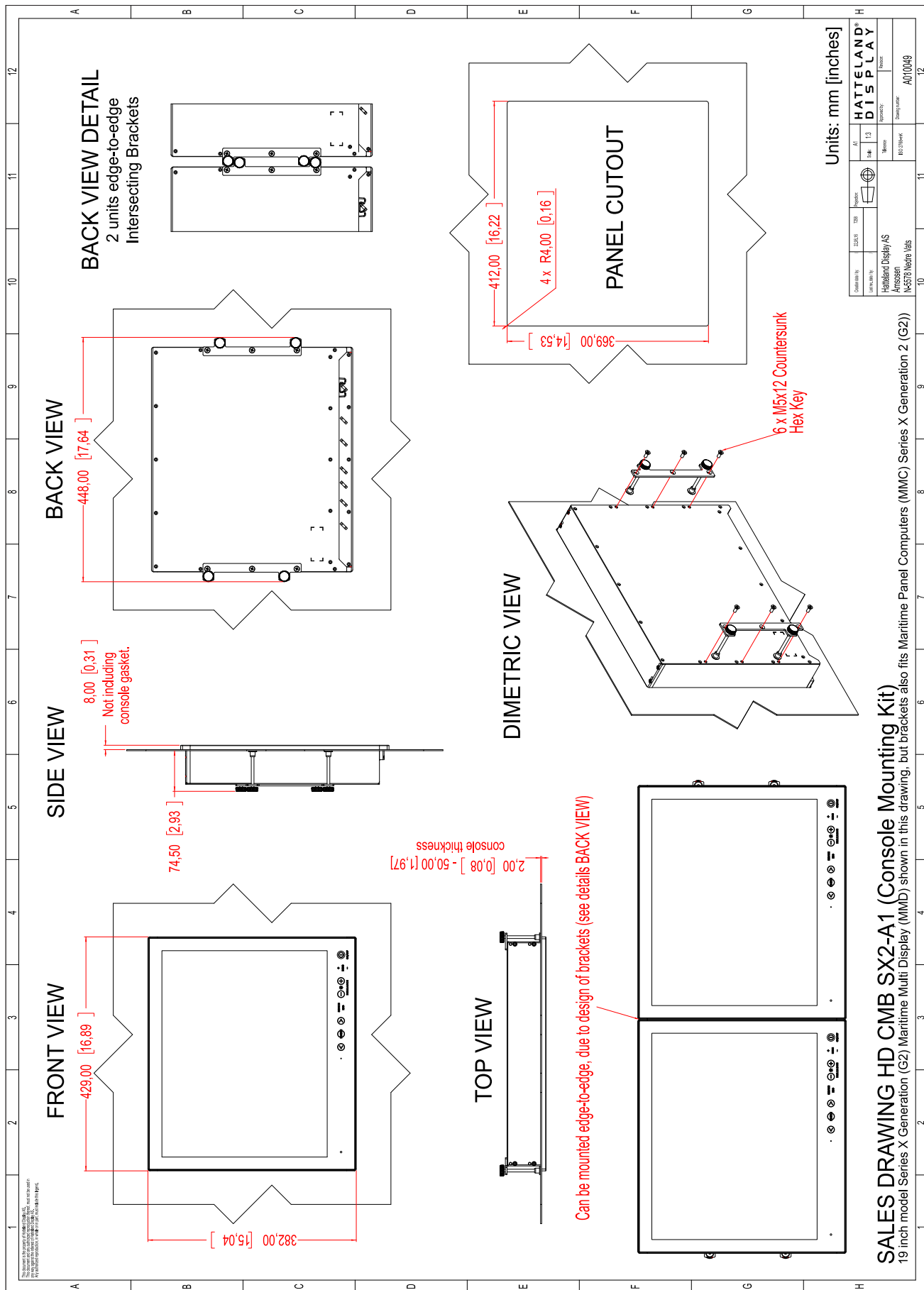

This document is the property of Hatteland Display AS. This document and any authorized reproduction thereof, must not be used in any way against the interest of Hatteland Display AS. Any authorized reproduction, in whole or in part, must include this legend. Hatteland Display Proprietary information. Not to be distributed to any third party without written permission.

Dimensions might be shown with or without decimals and indicated as mm [inches]. Tolerance on drawings is +/- 1mm. For accurate measurements, check relevant DWG file.

BRACKET INSTRUCTIONS

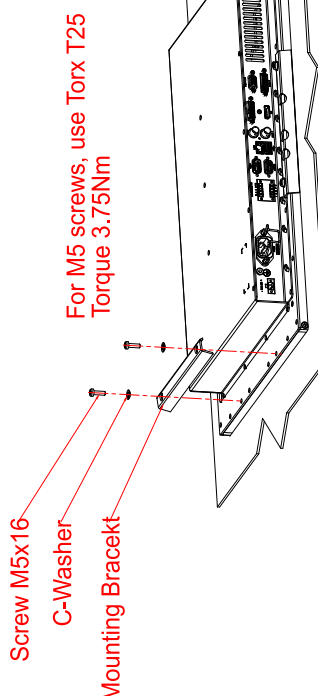
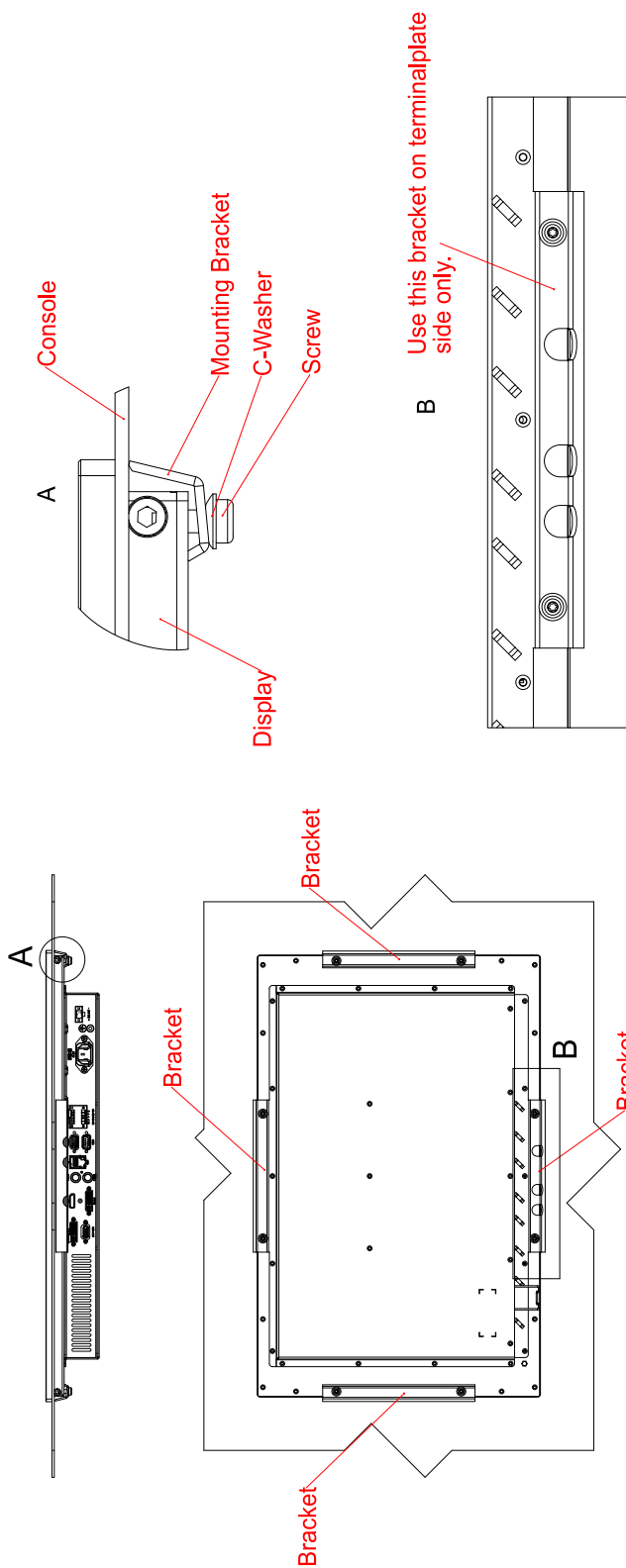

Units: mm [inches]

Creation date by	11.03.17	Revision	01
Last rev. date by	/	Revision	01
Author	Hatteland	Approved by	
Drawing number	AO10694		

SALES DRAWING HD CMB SX2-E1 (Console Mount Kit)
 Drawing shows HD 24T22 MMD - Series X Generation 2 (G2) model, but same procedure also applies for HD 24T22 MxC - Maritime Multi Computers (MMC) models.

This document is the property of Hatteland Display AS. This document and any authorized reproduction thereof, must not be used in any way against the interest of Hatteland Display AS. Any authorized reproduction, in whole or in part, must include this legend. Hatteland Display Proprietary information. Not to be distributed to any third party without written permission.

Technical Drawings - HD CMB SX2-E1

Dimensions might be shown with or without decimals and indicated as mm [inches]. Tolerance on drawings is +/- 1mm. For accurate measurements, check relevant DWG file.

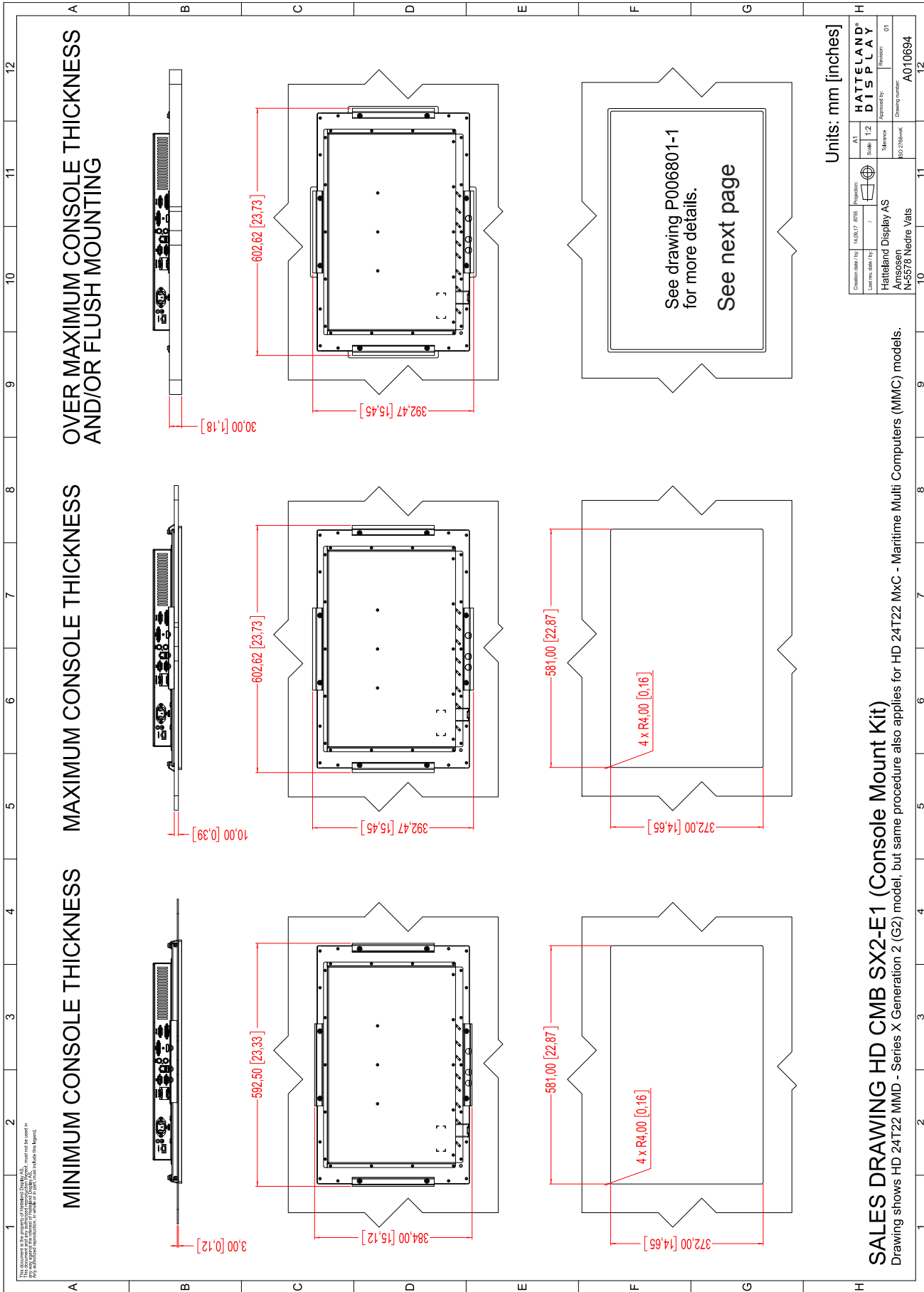

SALES DRAWING HD CMB SX2-E1 (Console Mount Kit)

Drawing shows HD 24T22 MMD - Series X Generation 2 (G2) model, but same procedure also applies for HD 24T22 MxC - Maritime Multi Computers (MMC) models.

This document is the property of Hatteland Display AS. This document and any authorized reproduction thereof, must not be used in any way against the interest of Hatteland Display AS. Any authorized reproduction, in whole or in part, must include this legend. Hatteland Display Proprietary information. Not to be distributed to any third party without written permission.

Technical Drawings - HD CMB SX2-E1

Dimensions might be shown with or without decimals and indicated as mm [inches]. Tolerance on drawings is +/- 1mm. For accurate measurements, check relevant DWG file.

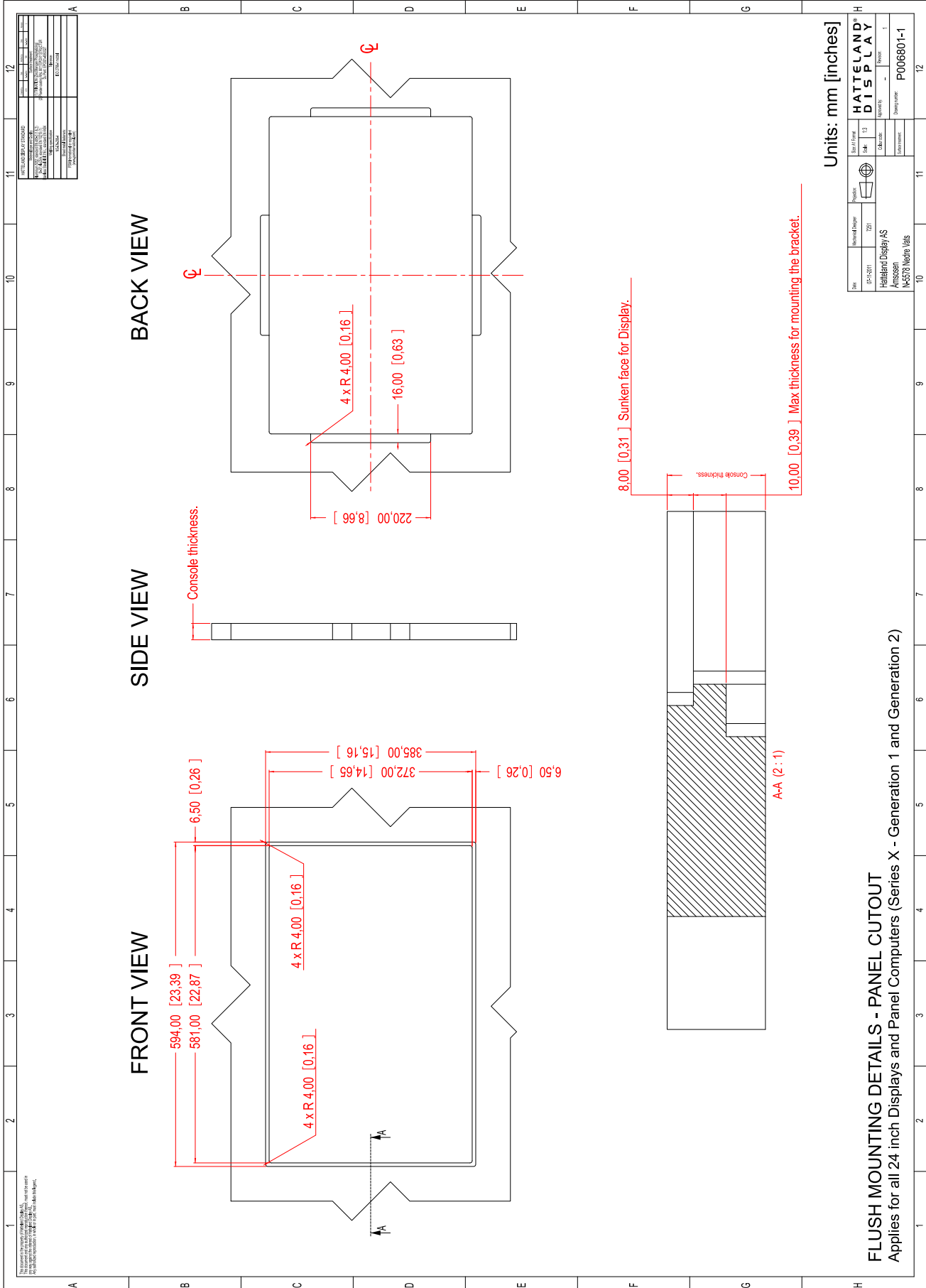

FLUSH MOUNTING DETAILS - PANEL CUTOUT
 Applies for all 24 inch Displays and Panel Computers (Series X - Generation 1 and Generation 2)

This document is the property of Hatteland Display AS. This document and any authorized reproduction thereof, must not be used in any way against the interest of Hatteland Display AS. Any authorized reproduction, in whole or in part, must include this legend. Hatteland Display Proprietary information. Not to be distributed to any third party without written permission.

Dimensions might be shown with or without decimals and indicated as mm [inches]. Tolerance on drawings is +/- 1mm. For accurate measurements, check relevant DWG file.

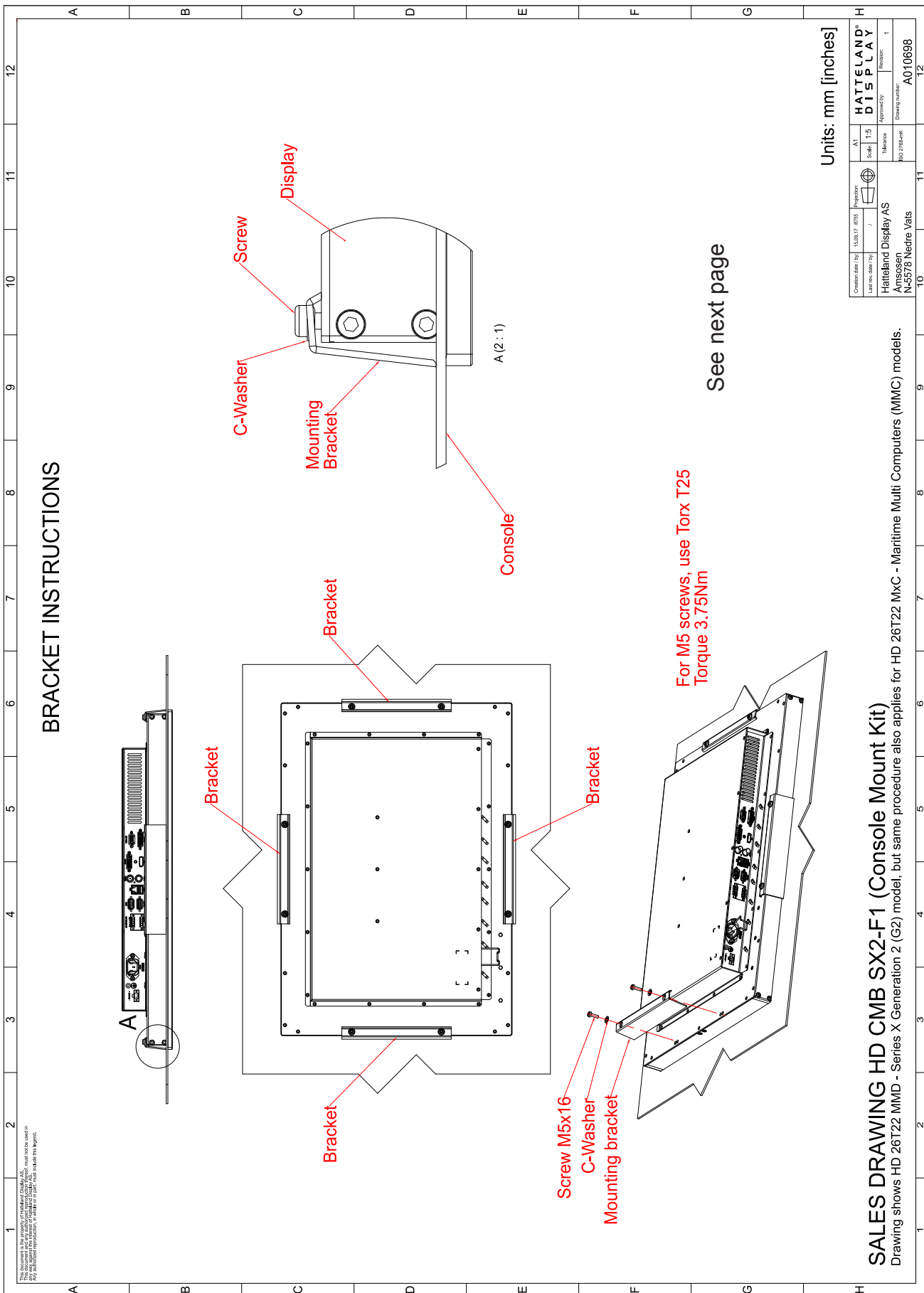

SALES DRAWING HD CMB SX2-F1 (Console Mount Kit)
 Drawing shows HD 26T22 MMD - Series X Generation 2 (G2) model, but same procedure also applies for HD 26T22 MxC - Maritime Multi Computers (MMC) models.

This document is the property of Hatteland Display AS. This document and any authorized reproduction thereof, must not be used in any way against the interest of Hatteland Display AS. Any authorized reproduction, in whole or in part, must include this legend. Hatteland Display Proprietary information. Not to be distributed to any third party without written permission.

Technical Drawings - HD CMB SX2-F1

Dimensions might be shown with or without decimals and indicated as mm [inches]. Tolerance on drawings is +/- 1mm. For accurate measurements, check relevant DWG file.

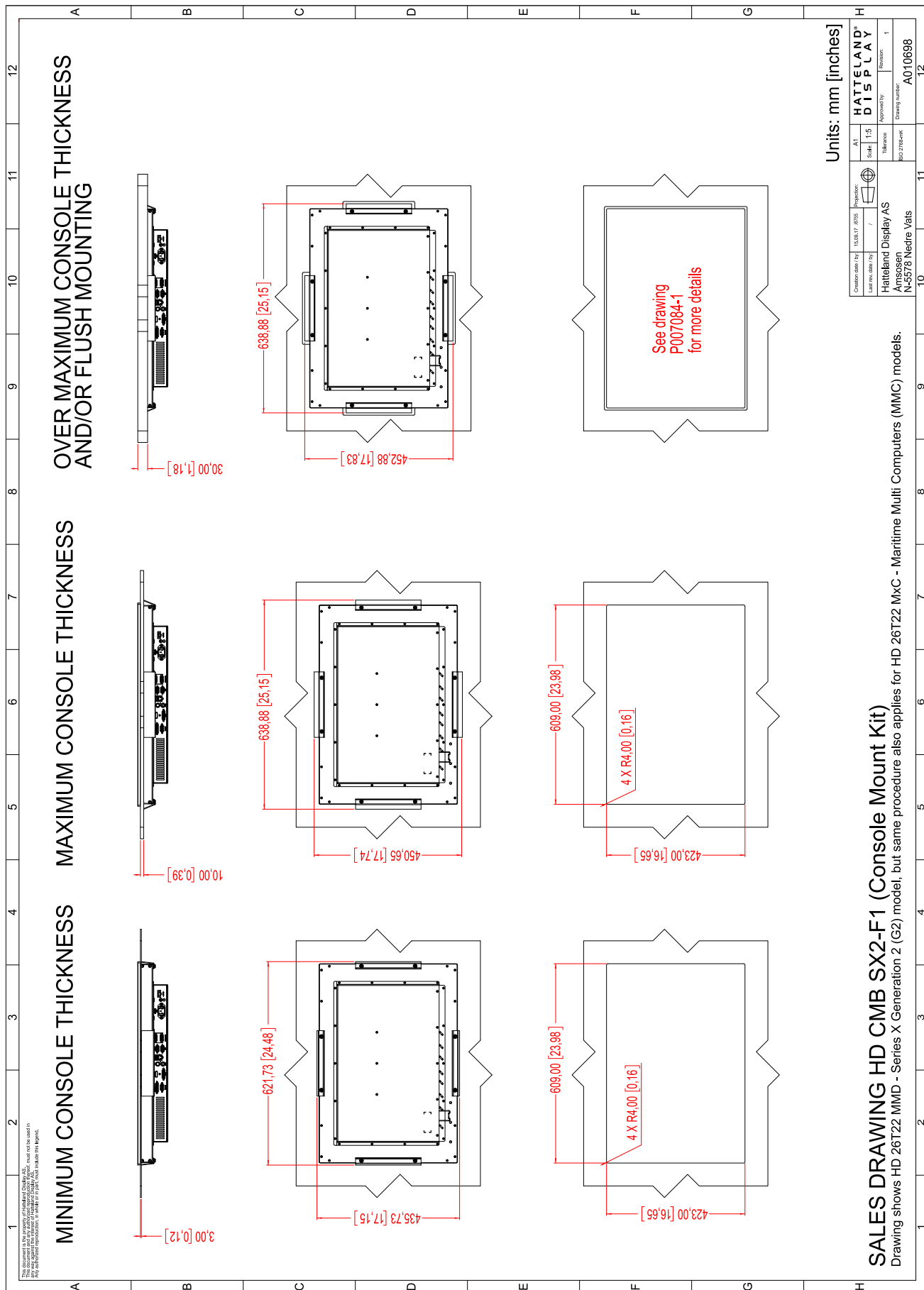

SALES DRAWING HD CMB SX2-F1 (Console Mount Kit)

Drawing shows HD 26T22 MMD - Series X Generation 2 (G2) model, but same procedure also applies for HD 26T22 MxC - Maritime Multi Computers (MMC) models.

This document is the property of Hatteland Display AS. This document and any authorized reproduction thereof, must not be used in any way against the interest of Hatteland Display AS. Any authorized reproduction, in whole or in part, must include this legend. Hatteland Display Proprietary information. Not to be distributed to any third party without written permission.

Technical Drawings - HD CMB SX2-F1

Dimensions might be shown with or without decimals and indicated as mm [inches]. Tolerance on drawings is +/- 1mm. For accurate measurements, check relevant DWG file.

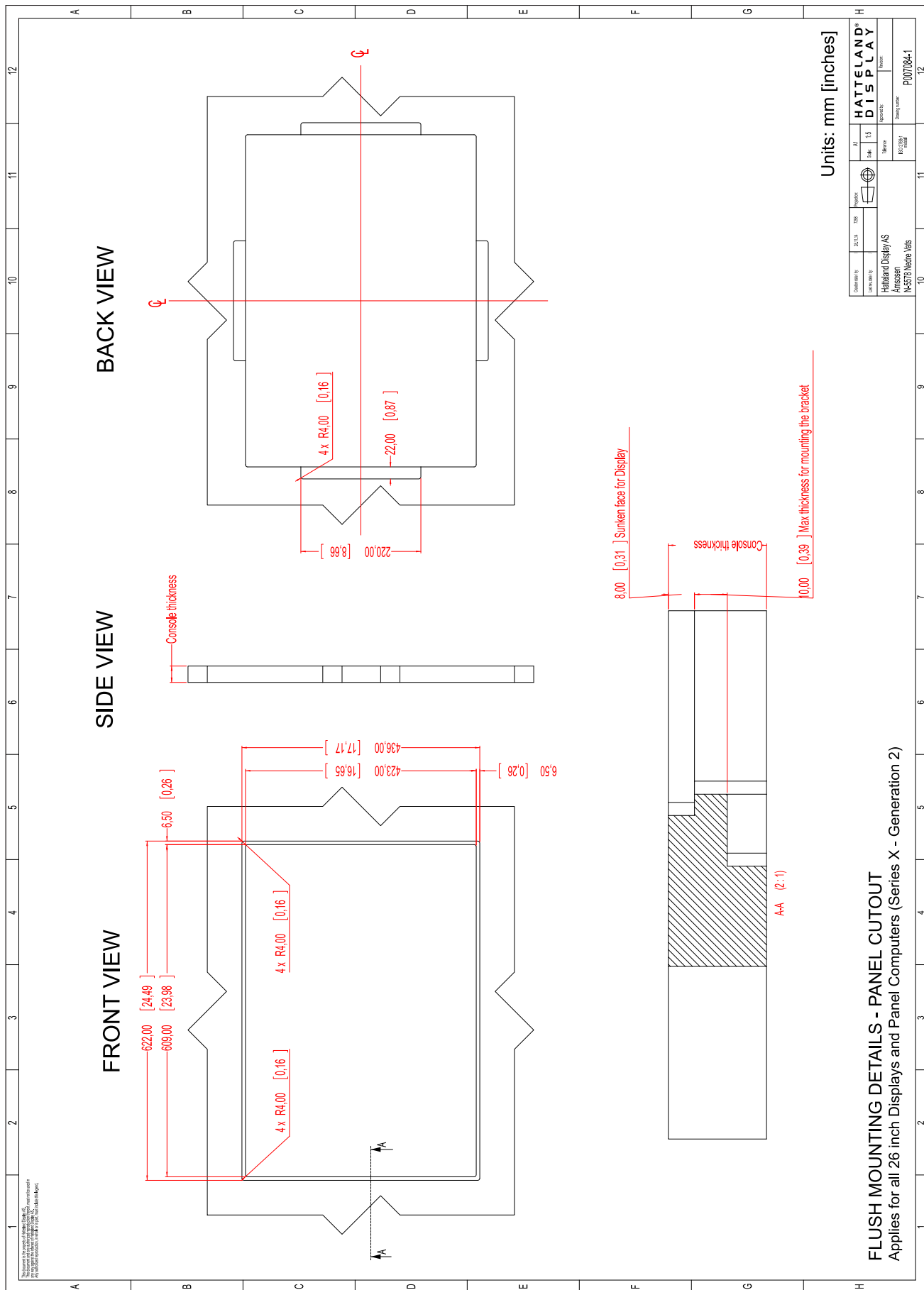

This document is the property of Hatteland Display AS. This document and any authorized reproduction thereof, must not be used in any way against the interest of Hatteland Display AS. Any authorized reproduction, in whole or in part, must include this legend. Hatteland Display Proprietary information. Not to be distributed to any third party without written permission.

P007084-1 Flush Mounting 26 inch 117

Dimensions might be shown with or without decimals and indicated as mm [inches]. Tolerance on drawings is +/- 1mm. For accurate measurements, check relevant DWG file.

BRACKET INSTRUCTIONS

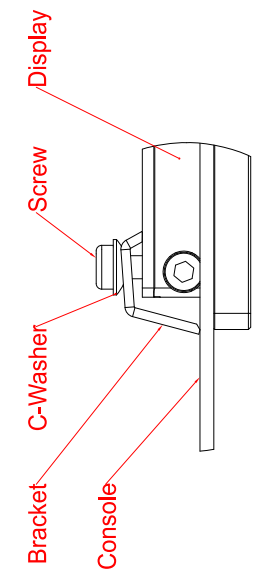

A (2 : 1)

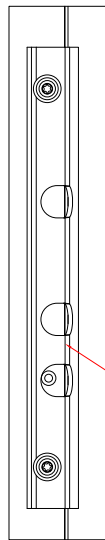

B (1 : 1)

Use this bracket on terminal plate side only.

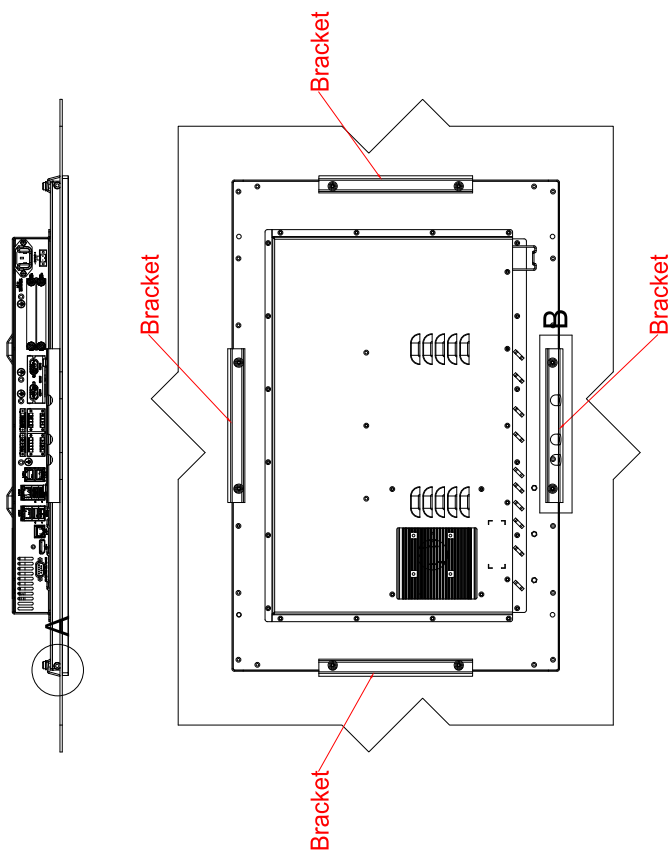

For M5 screws, use Torx T25 - Torque 3.75Nm

Screw M5x16
C-Washer
Mounting Bracket

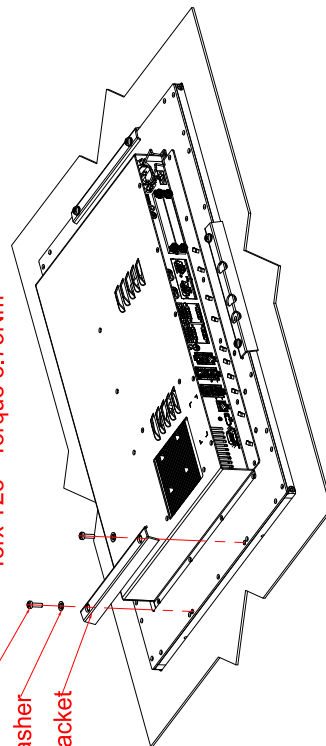

SALES DRAWING HD CMB SX2-E1 (Console Mount Kit)

Drawing shows HD 27T22 MxC - Series X Generation 2 (G2) model, but same procedure also applies for HD 27T22 MMD - Maritime Multi Display (MMD) models.

Units: mm [inches]

Created by	15.06.17	RTS	Revision	A1
Drawn by			Scale	1:5
Checked by			Material	HATTELAND DISPLAY
Approved by			Drawing number	A010701
			Revision	01

This document is the property of Hatteland Display AS. This document and any authorized reproduction thereof, must not be used in any way against the interest of Hatteland Display AS. Any authorized reproduction, in whole or in part, must include this legend. Hatteland Display Proprietary information. Not to be distributed without written permission.

Technical Drawings - HD CMB SX2-E1

Dimensions might be shown with or without decimals and indicated as mm [inches]. Tolerance on drawings is +/- 1mm. For accurate measurements, check relevant DWG file.

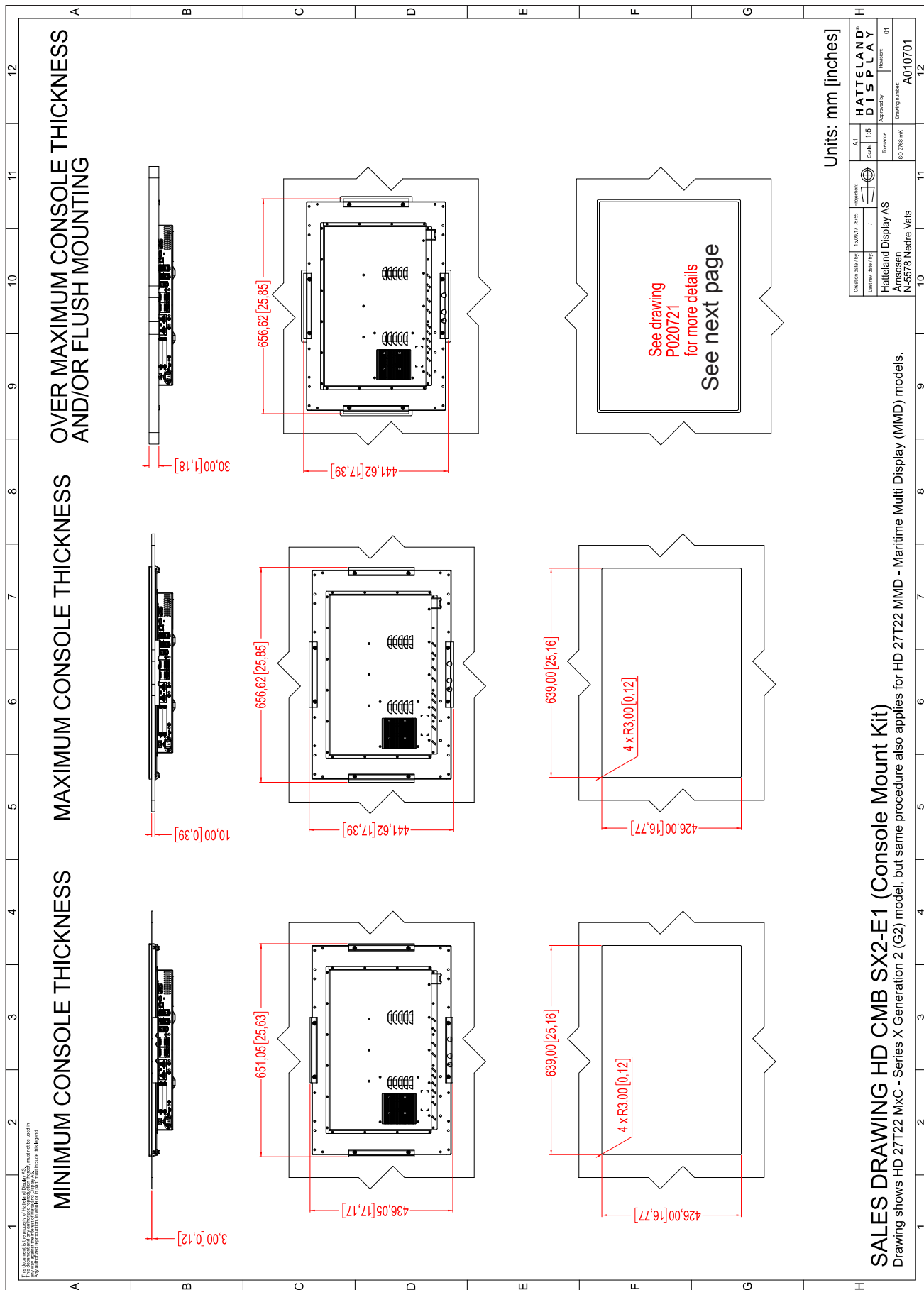

SALES DRAWING HD CMB SX2-E1 (Console Mount Kit)

Drawing shows HD 27T22 MxC - Series X Generation 2 (G2) model, but same procedure also applies for HD 27T22 MMD - Maritime Multi Display (MMD) models.

This document is the property of Hatteland Display AS. This document and any authorized reproduction thereof, must not be used in any way against the interest of Hatteland Display AS. Any authorized reproduction, in whole or in part, must include this legend. Hatteland Display Proprietary information. Not to be distributed to any third party without written permission.

Technical Drawings - HD CMB SX2-E1

Dimensions might be shown with or without decimals and indicated as mm [inches]. Tolerance on drawings is +/- 1mm. For accurate measurements, check relevant DWG file.

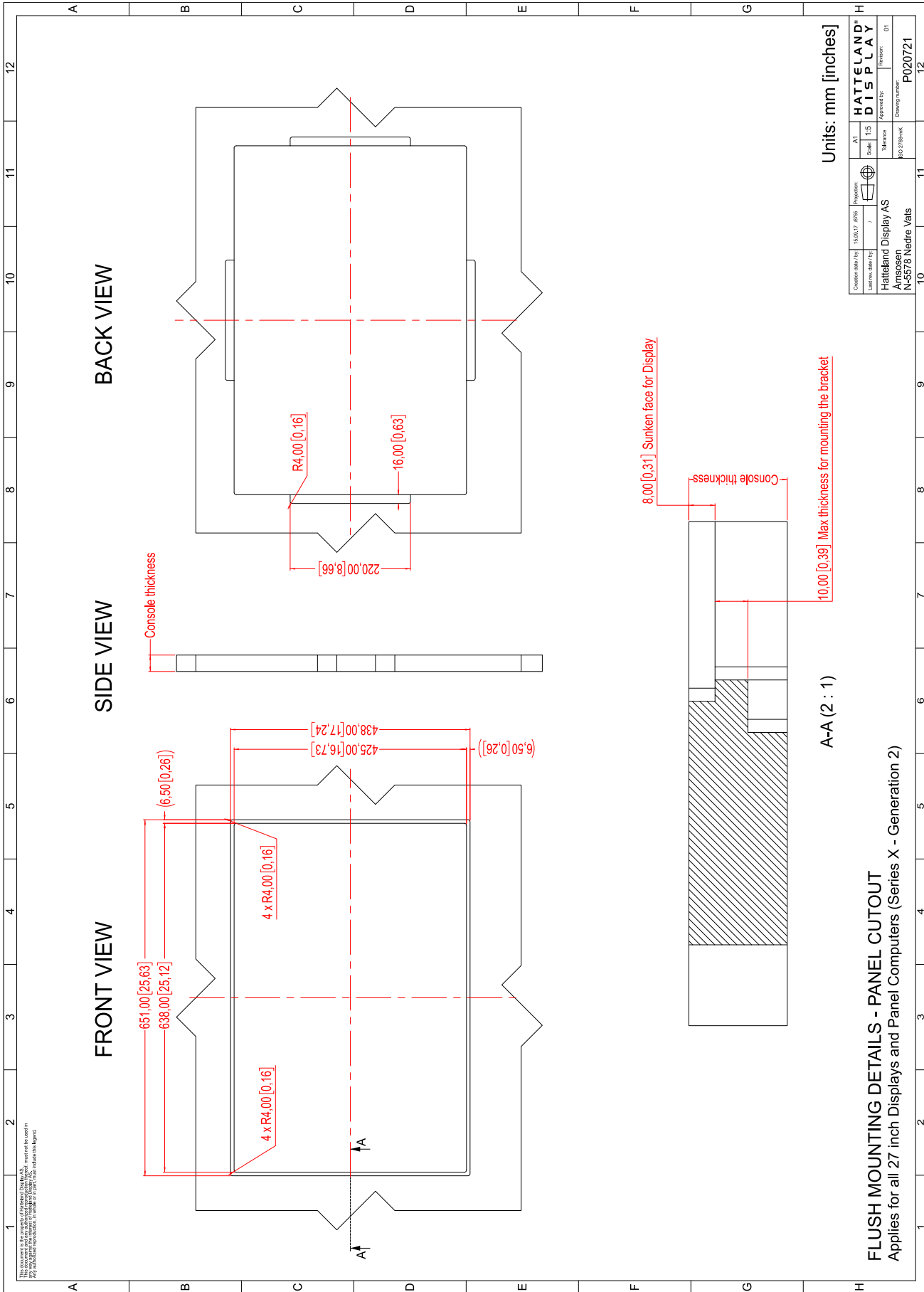

FLUSH MOUNTING DETAILS - PANEL CUTOUT
Applies for all 27 inch Displays and Panel Computers (Series X - Generation 2)

This document is the property of Hatteland Display AS. This document and any authorized reproduction thereof, must not be used in any way against the interest of Hatteland Display AS. Any authorized reproduction, in whole or in part, must include this legend. Hatteland Display Proprietary information. Not to be distributed to any third party without written permission.

Technical Drawings - HD VED SX2-A1

Dimensions might be shown with or without decimals and indicated as mm [inches]. Tolerance on drawings is +/- 1mm. For accurate measurements, check relevant DWG file.

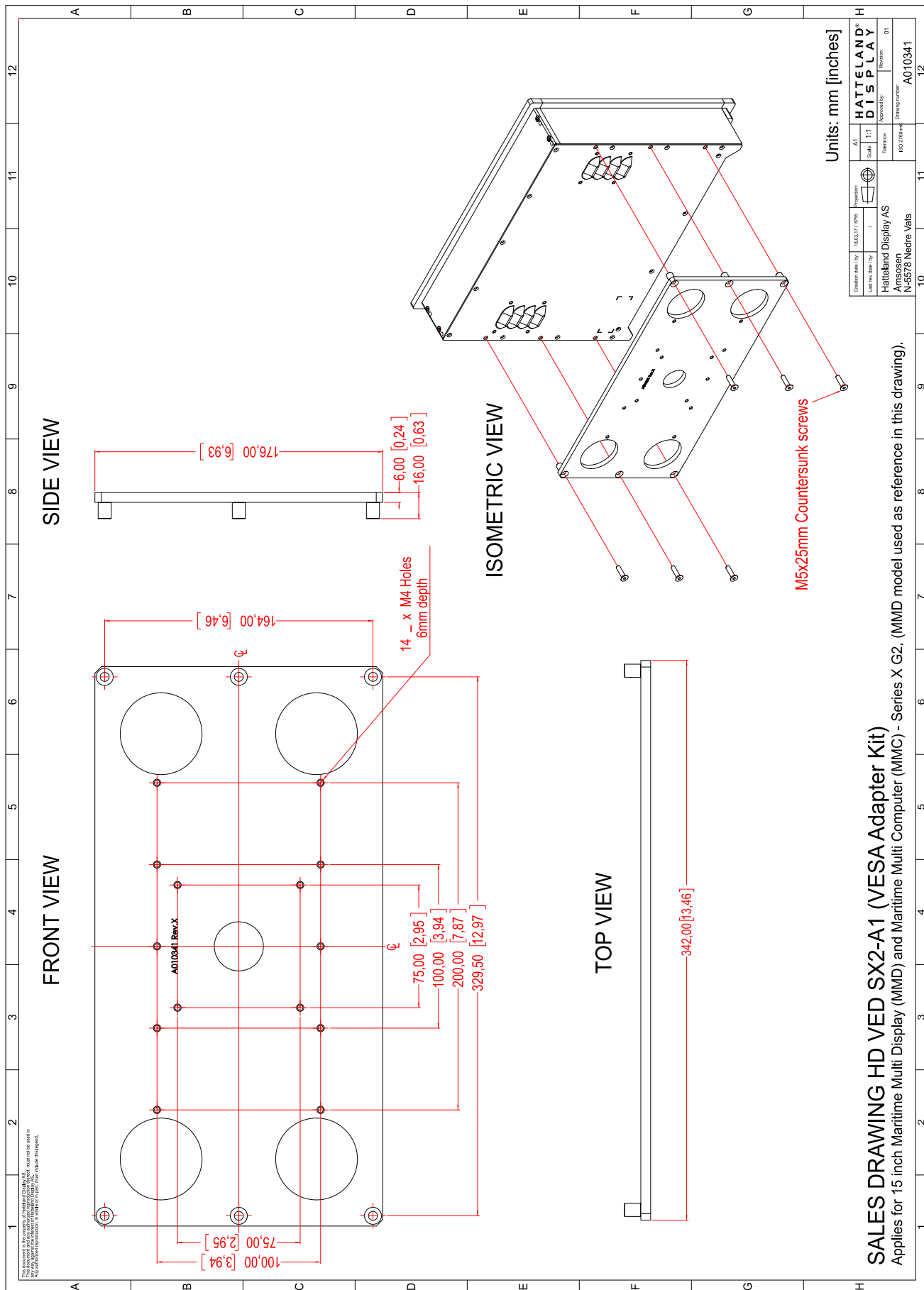

This document is the property of Hatteland Display AS. This document and any authorized reproduction thereof, must not be used in any way against the interest of Hatteland Display AS. Any authorized reproduction, in whole or in part, must include this legend. Hatteland Display Proprietary information. Not to be distributed to any third party without written permission.

Technical Drawings - HD VED SX2-B1

Dimensions might be shown with or without decimals and indicated as mm [inches]. Tolerance on drawings is +/- 1mm. For accurate measurements, check relevant DWG file.

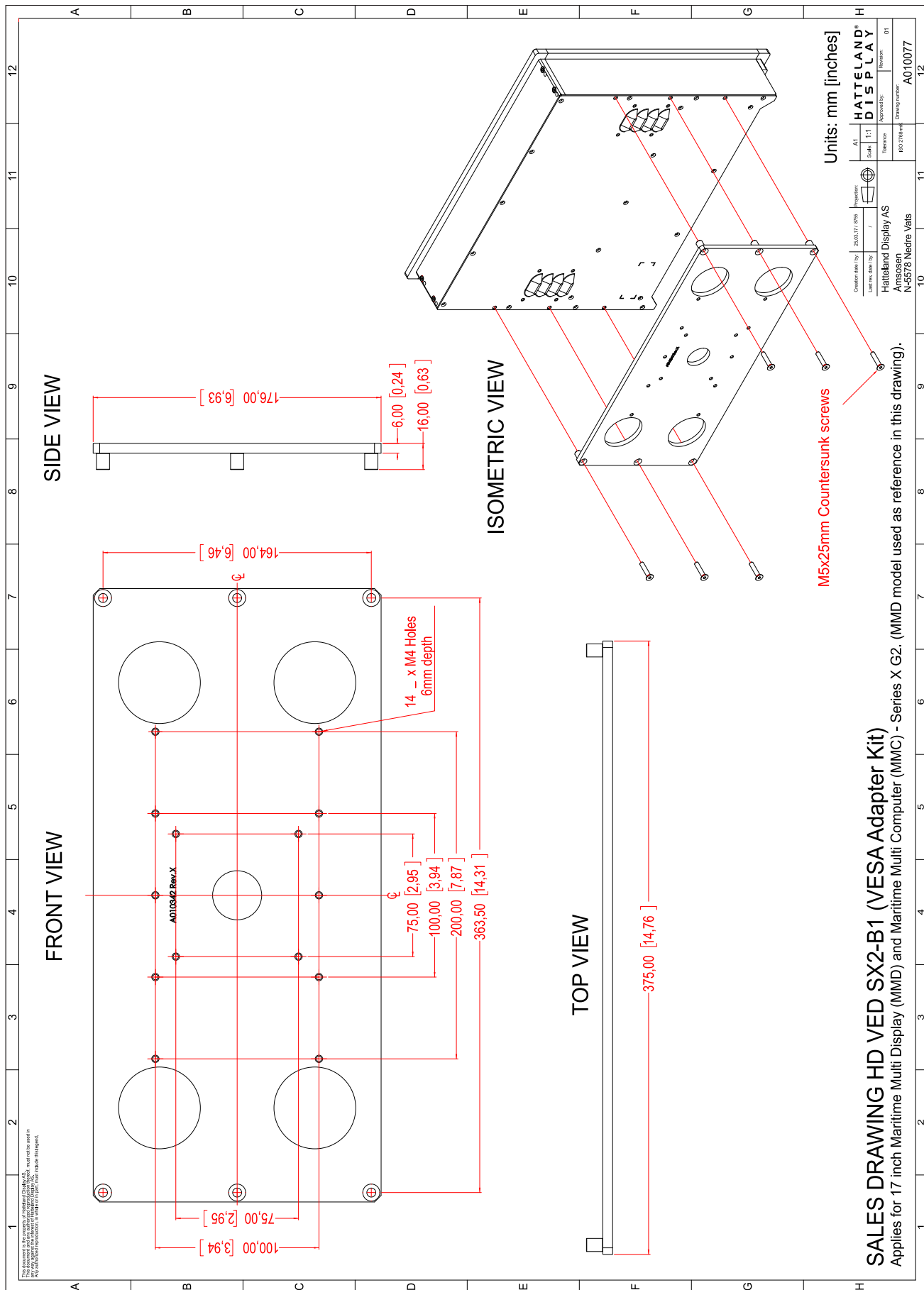

This document is the property of Hatteland Display AS. This document and any authorized reproduction thereof, must not be used in any way against the interest of Hatteland Display AS. Any authorized reproduction, in whole or in part, must include this legend. Hatteland Display Proprietary information. Not to be distributed to any third party without written permission.

Technical Drawings - HD VED SX2-C1

Dimensions might be shown with or without decimals and indicated as mm [inches]. Tolerance on drawings is +/- 1mm. For accurate measurements, check relevant DWG file.

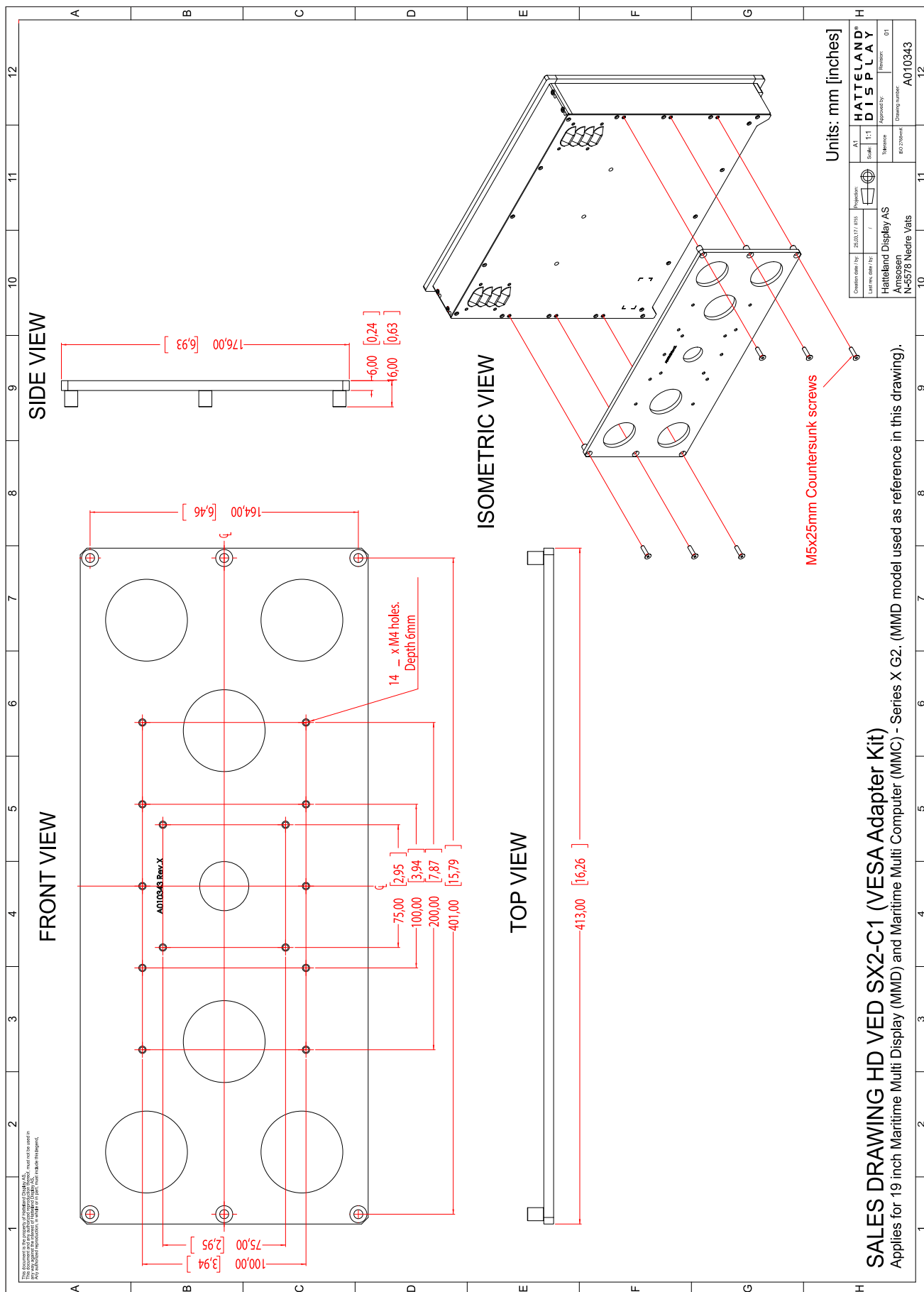

This document is the property of Hatteland Display AS. This document and any authorized reproduction thereof, must not be used in any way against the interest of Hatteland Display AS. Any authorized reproduction, in whole or in part, must include this legend. Hatteland Display Proprietary information. Not to be distributed to any third party without written permission.

Technical Drawings - HD VED SX2-H1

Dimensions might be shown with or without decimals and indicated as mm [inches]. Tolerance on drawings is +/- 1mm. For accurate measurements, check relevant DWG file.

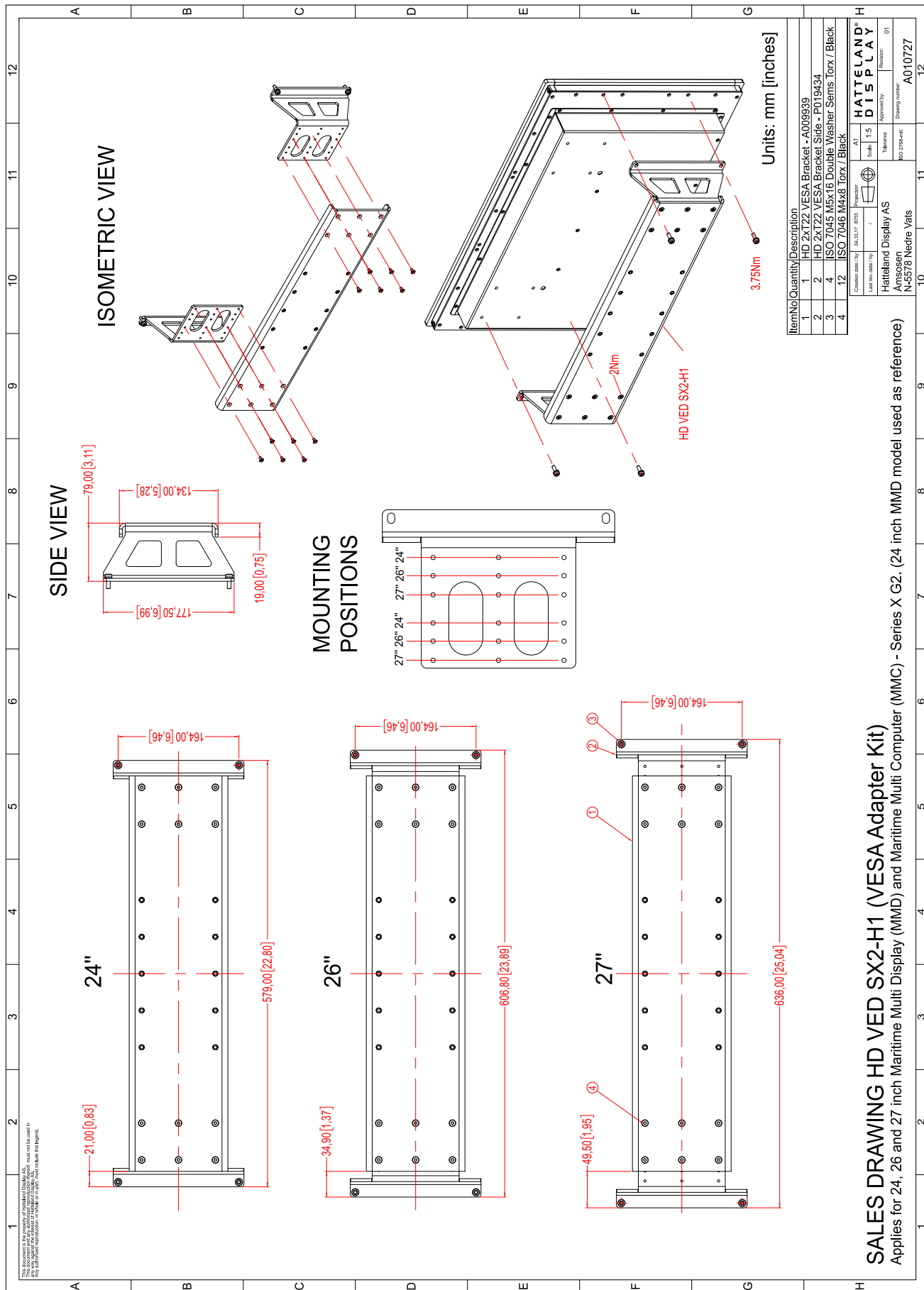

This document is the property of Hatteland Display AS. This document and any authorized reproduction thereof, must not be used in any way against the interest of Hatteland Display AS. Any authorized reproduction, in whole or in part, must include this legend. Hatteland Display Proprietary information. Not to be distributed to any third party without written permission.

Technical Drawings - JH 15TAP STD-C1

Dimensions might be shown with or without decimals and indicated as mm [inches]. Tolerance on drawings is +/- 1mm. For accurate measurements, check relevant DWG file.

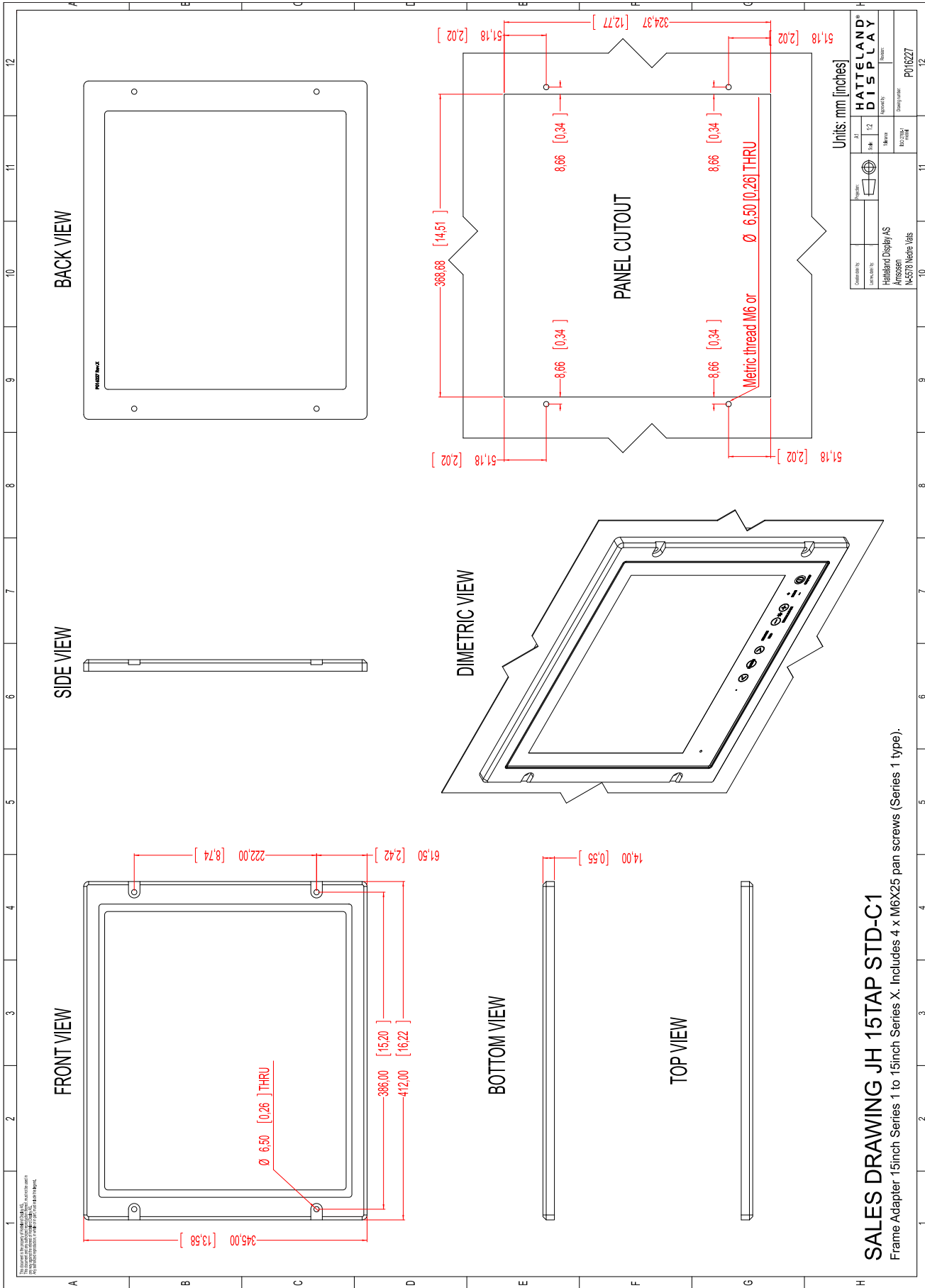

SALES DRAWING JH 15TAP STD-C1

Frame Adapter 15inch Series 1 to 15inch Series X. Includes 4 x M6X25 pan screws (Series 1 type).

This document is the property of Hatteland Display AS. This document and any authorized reproduction thereof, must not be used in any way against the interest of Hatteland Display AS. Any authorized reproduction, in whole or in part, must include this legend. Hatteland Display Proprietary information. Not to be distributed to any third party without written permission.

Technical Drawings - JH 19TAP STD-C1

Dimensions might be shown with or without decimals and indicated as mm [inches]. Tolerance on drawings is +/- 1mm. For accurate measurements, check relevant DWG file.

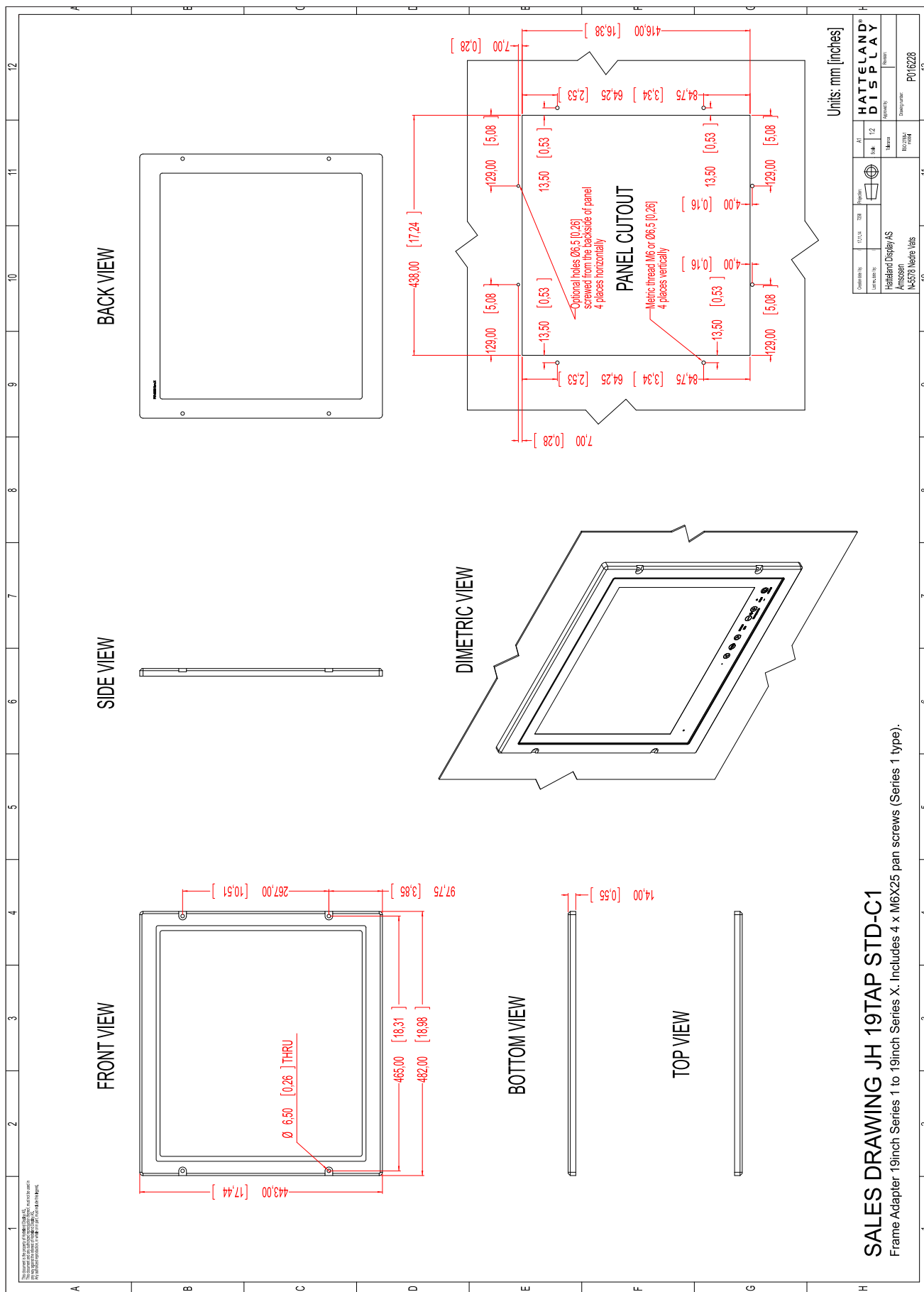

SALES DRAWING JH 19TAP STD-C1

Frame Adapter 19inch Series 1 to 19inch Series X. Includes 4 x M6x25 pan screws (Series 1 type).

This document is the property of Hatteland Display AS. This document and any authorized reproduction thereof, must not be used in any way against the interest of Hatteland Display AS. Any authorized reproduction, in whole or in part, must include this legend. Hatteland Display Proprietary information. Not to be distributed to any third party without written permission.

Technical Drawings - HD 19TAP SX2-C2

Dimensions might be shown with or without decimals and indicated as mm [inches]. Tolerance on drawings is +/- 1mm. For accurate measurements, check relevant DWG file.

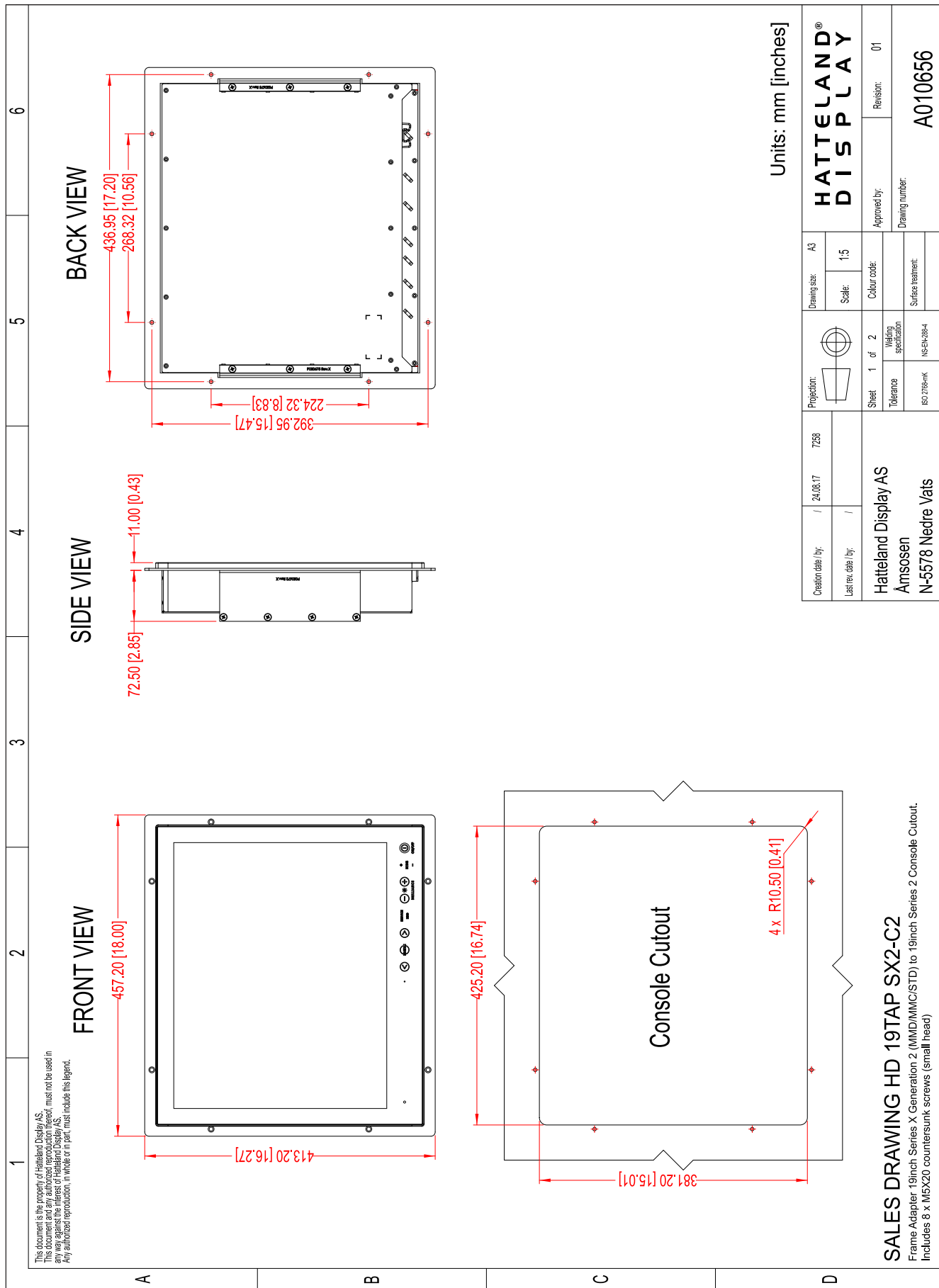

This document is the property of Hatteland Display AS. This document and any authorized reproduction thereof, must not be used in any way against the interest of Hatteland Display AS. Any authorized reproduction, in whole or in part, must include this legend. Hatteland Display Proprietary information. Not to be distributed to any third party without written permission.

Technical Drawings - HD 19TAP SX2-C2

Dimensions might be shown with or without decimals and indicated as mm [inches]. Tolerance on drawings is +/- 1mm. For accurate measurements, check relevant DWG file.

This document is the property of Hatteland Display AS. This document and any information herein must not be used in any way against the interest of Hatteland Display AS. Any authorized reproduction, in whole or in part, must include this legend.

	2	3	4	5	6
A					
B					
C					
D					

ItemNo	Quantity	Description
1	1	Console adapter plate 19T03 to 19T22
2	2	HD TAP SX2-x1 Foot
3	8	ISO 7046-1 - M5 x 16
4	1	HD 19T22 MMD
5	6	ISO 7046-1 - M5 x 20
6	1	Panel Cut Out HD19T03-F
7	8	SNFS M5x20 Countersunk Small Head Screws

Creation date: / /	24.08.17	7238	Projection:		Drawing size:	A3
Last rev. date: / /	/ /	/	Sheet	2 of 2	Scale:	1:5
Hatteland Display AS			Tolerance	ISO 2768-mS	Colour code:	
Åmsosen			Welding specification	ISO 2554	Approved by:	Revision: 01
N-5578 Nedre Vats			ISO 2768-mS	Surface treatment:	Drawing number:	A010656

SALES DRAWING HD 19TAP SX2-C2
 Frame Adapter 19inch Series X Generation 2 (MMD/MMC/STD) to 19inch Series 2 Console Cutout.
 Includes 8 x M5X20 countersunk screws (small head)

This document is the property of Hatteland Display AS. This document and any authorized reproduction thereof, must not be used in any way against the interest of Hatteland Display AS. Any authorized reproduction, in whole or in part, must include this legend. Hatteland Display Proprietary information. Not to be distributed to any third party without written permission.

Technical Drawings - JH 26TAP STD-A1

Dimensions might be shown with or without decimals and indicated as mm [inches]. Tolerance on drawings is +/- 1mm. For accurate measurements, check relevant DWG file.

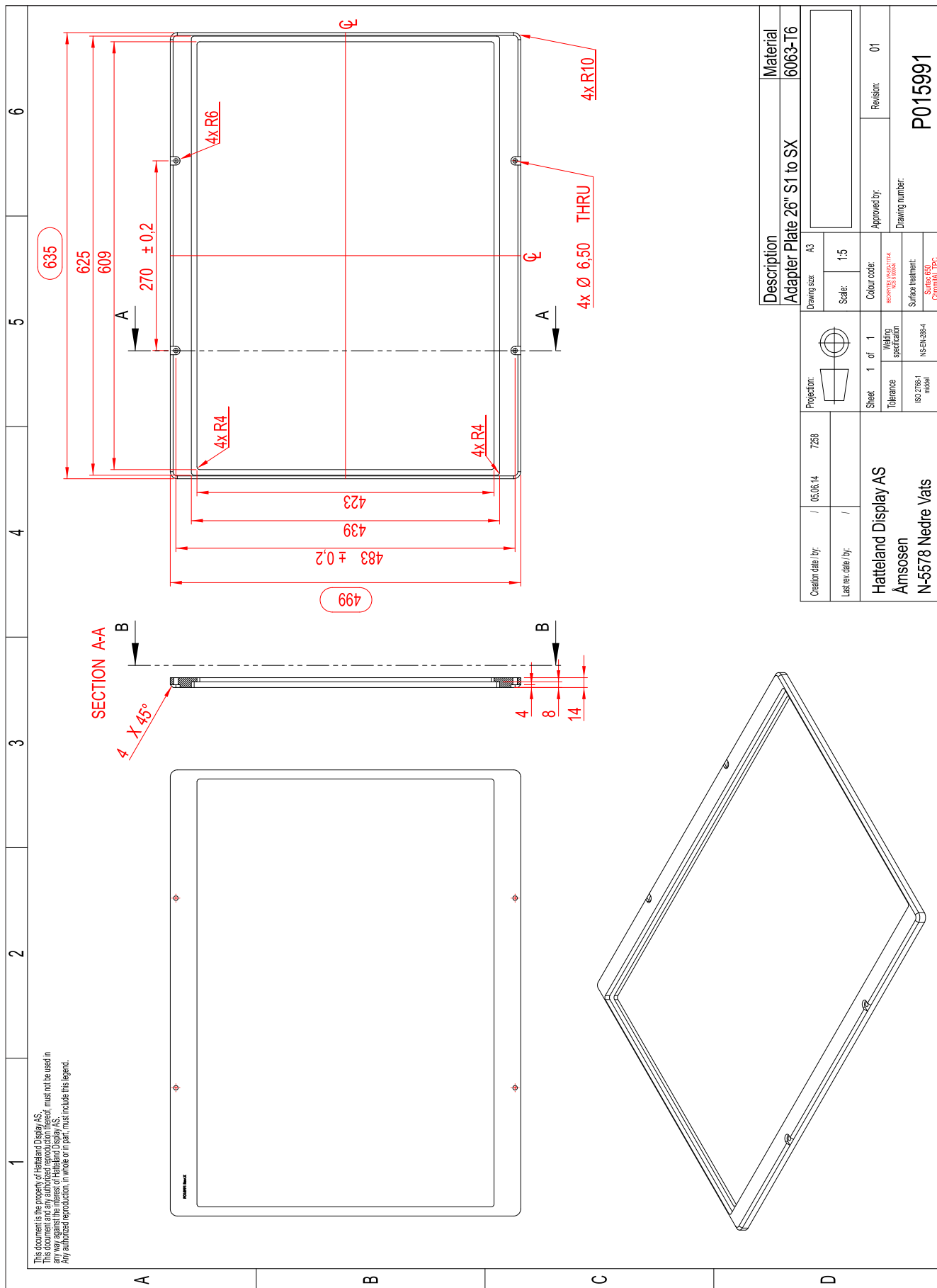

This document is the property of Hatteland Display AS. This document and any authorized reproduction thereof, must not be used in any way against the interest of Hatteland Display AS. Any authorized reproduction, in whole or in part, must include this legend. Hatteland Display Proprietary information. Not to be distributed to any third party without written permission.

Technical Drawings - HD 15COV SX1-A1

Dimensions might be shown with or without decimals and indicated as mm [inches]. Tolerance on drawings is +/- 1mm. For accurate measurements, check relevant DWG file.

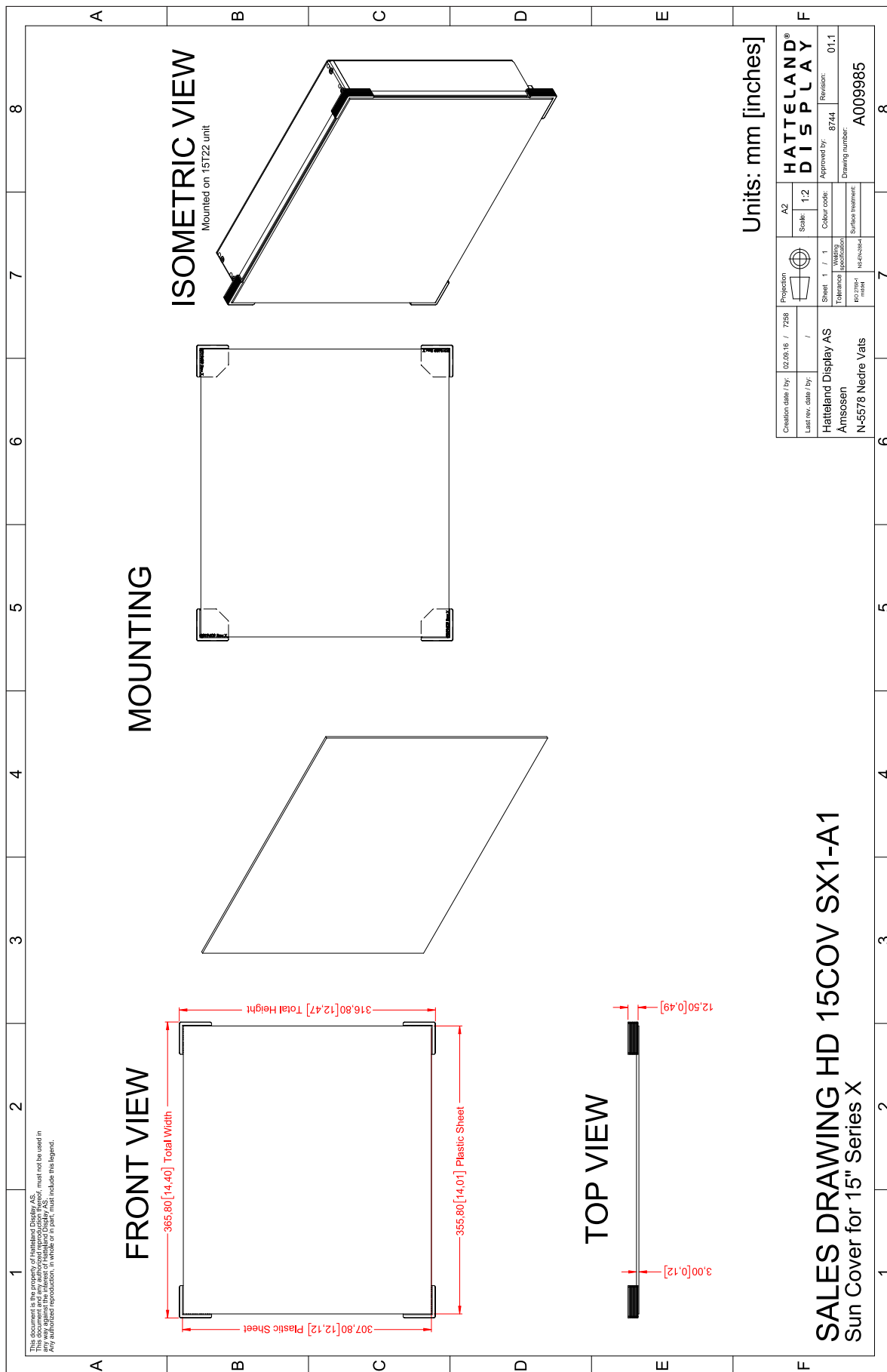

UV Sun Cover (15 inch)

130

This document is the property of Hatteland Display AS. This document and any authorized reproduction thereof, must not be used in any way against the interest of Hatteland Display AS. Any authorized reproduction, in whole or in part, must include this legend. Hatteland Display Proprietary information. Not to be distributed to any third party without written permission.

Dimensions might be shown with or without decimals and indicated as mm [inches]. Tolerance on drawings is +/- 1mm. For accurate measurements, check relevant DWG file.

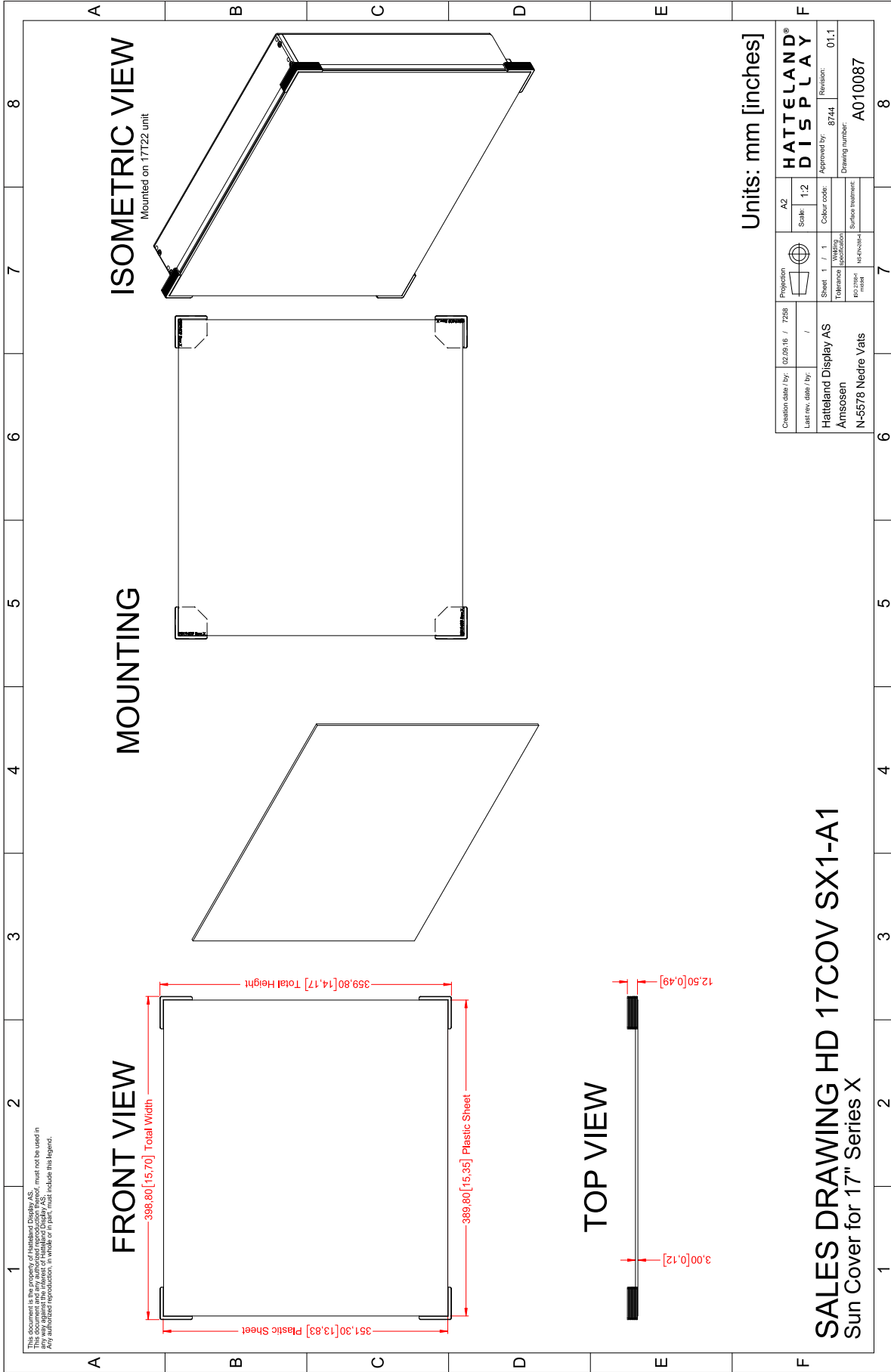

This document is the property of Hatteland Display AS. This document and any authorized reproduction thereof, must not be used in any way against the interest of Hatteland Display AS. Any authorized reproduction, in whole or in part, must include this legend. Hatteland Display Proprietary information. Not to be distributed to any third party without written permission.

Dimensions might be shown with or without decimals and indicated as mm [inches]. Tolerance on drawings is +/- 1mm. For accurate measurements, check relevant DWG file.

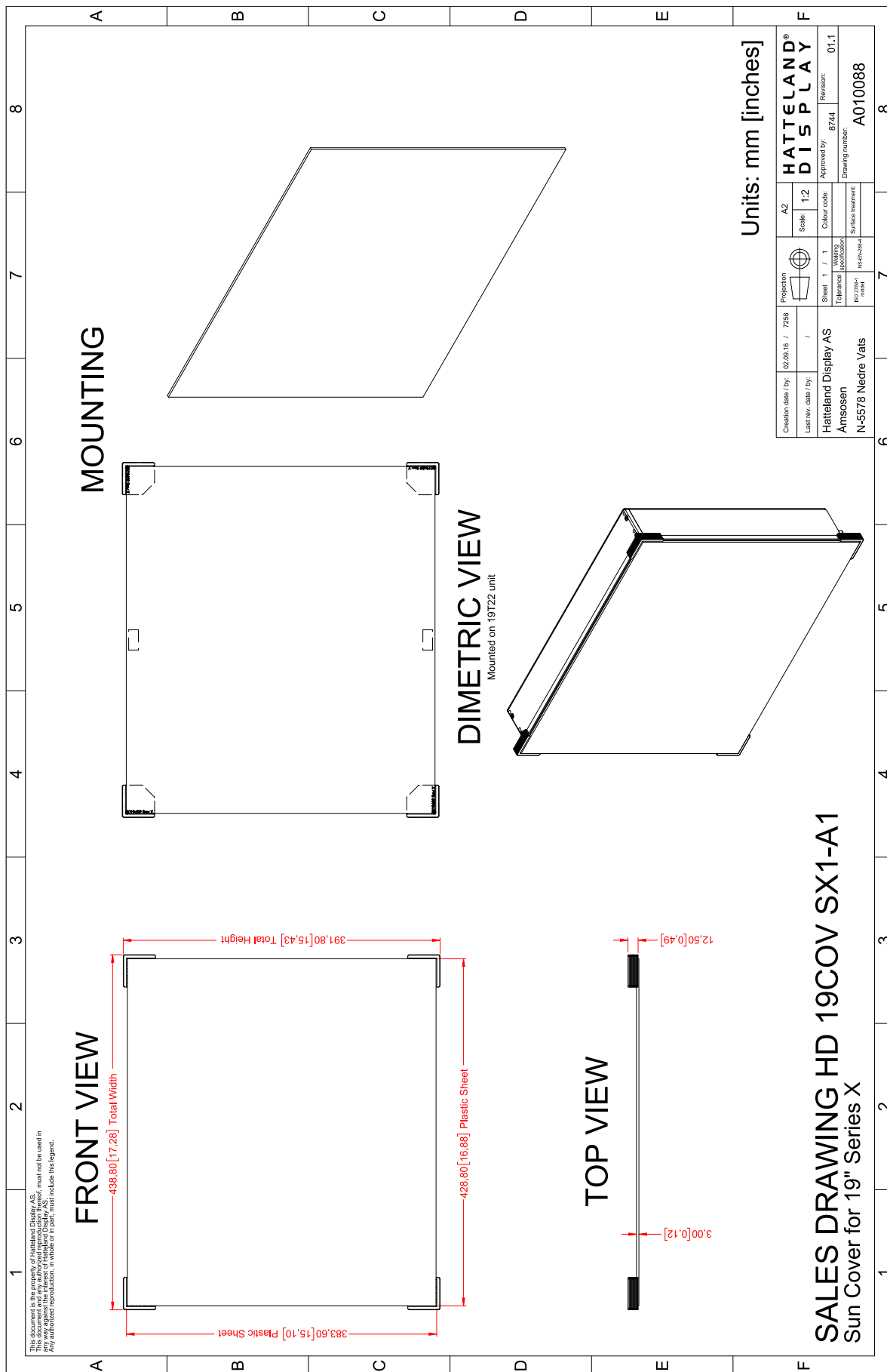

Technical Drawings - HD 24COV SX1-A1

Dimensions might be shown with or without decimals and indicated as mm [inches]. Tolerance on drawings is +/- 1mm. For accurate measurements, check relevant DWG file.

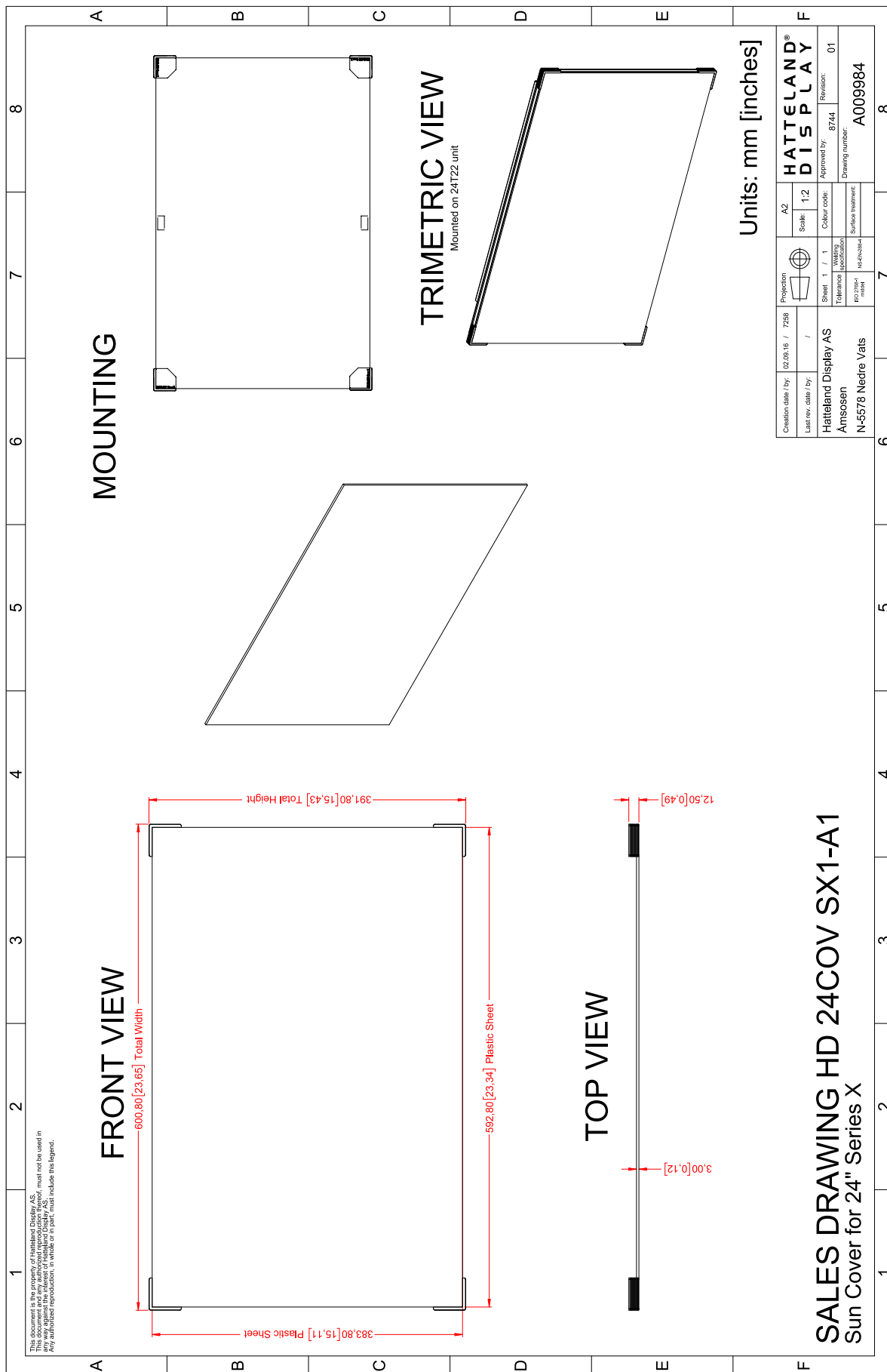

Technical Drawings - HD 26COV SX1-A1

Dimensions might be shown with or without decimals and indicated as mm [inches]. Tolerance on drawings is +/- 1mm. For accurate measurements, check relevant DWG file.

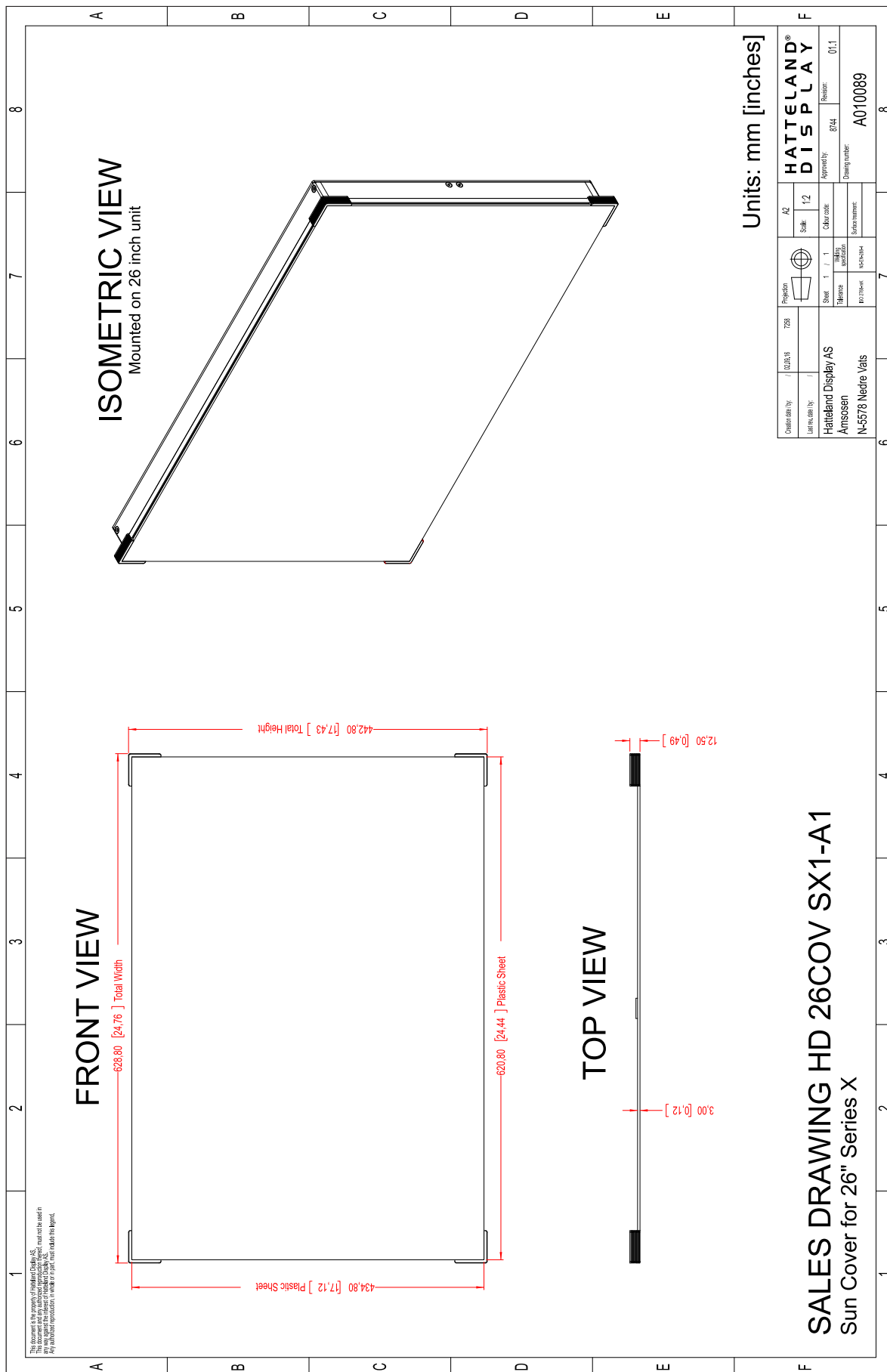

Units: mm [inches]

Created by:	10/26/16	726	Revision	A2
Drawn by:	Hatteland Display AS		Scale:	1:2
Checked by:	Ansosjen		Sheet:	1 / 1
Approved by:	N-5578 Nedre Vals		Other code:	8744
			Tolerance:	01.1
			Drawing number:	A010089
			Supplement:	

SALES DRAWING HD 26COV SX1-A1
Sun Cover for 26" Series X

Dimensions might be shown with or without decimals and indicated as mm [inches]. Tolerance on drawings is +/- 1mm. For accurate measurements, check relevant DWG file.

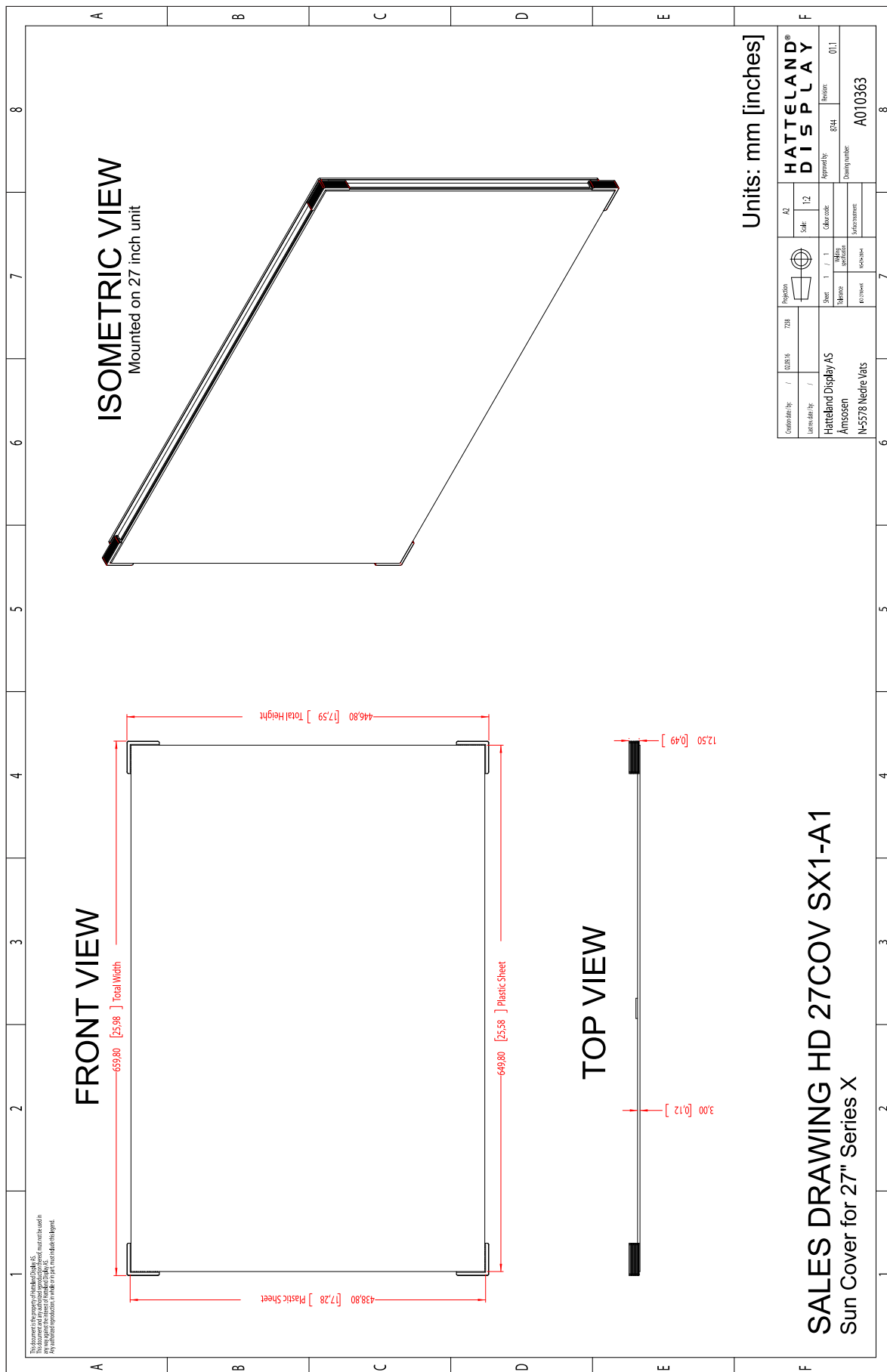

This document is the property of Hatteland Display AS. This document and any authorized reproduction thereof, must not be used in any way against the interest of Hatteland Display AS. Any authorized reproduction, in whole or in part, must include this legend. Hatteland Display Proprietary information. Not to be distributed to any third party without written permission.

Technical Drawings - P006997-1

Dimensions might be shown with or without decimals and indicated as mm [inches]. Tolerance on drawings is +/- 1mm. For accurate measurements, check relevant DWG file.

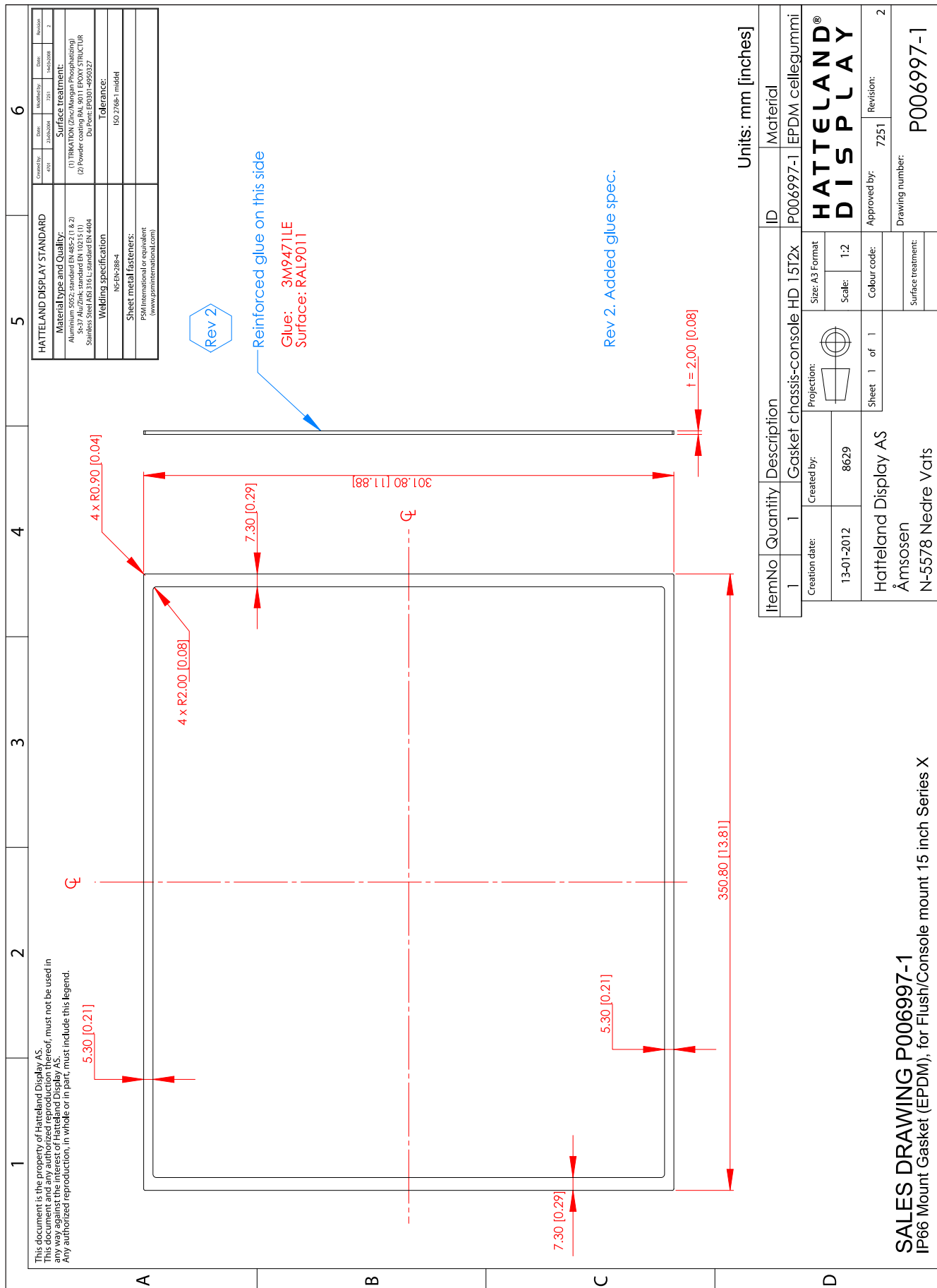

This document is the property of Hatteland Display AS. This document and any authorized reproduction thereof, must not be used in any way against the interest of Hatteland Display AS. Any authorized reproduction, in whole or in part, must include this legend. Hatteland Display Proprietary information. Not to be distributed to any third party without written permission.

Technical Drawings - P007130-1

Dimensions might be shown with or without decimals and indicated as mm [inches]. Tolerance on drawings is +/- 1mm. For accurate measurements, check relevant DWG file.

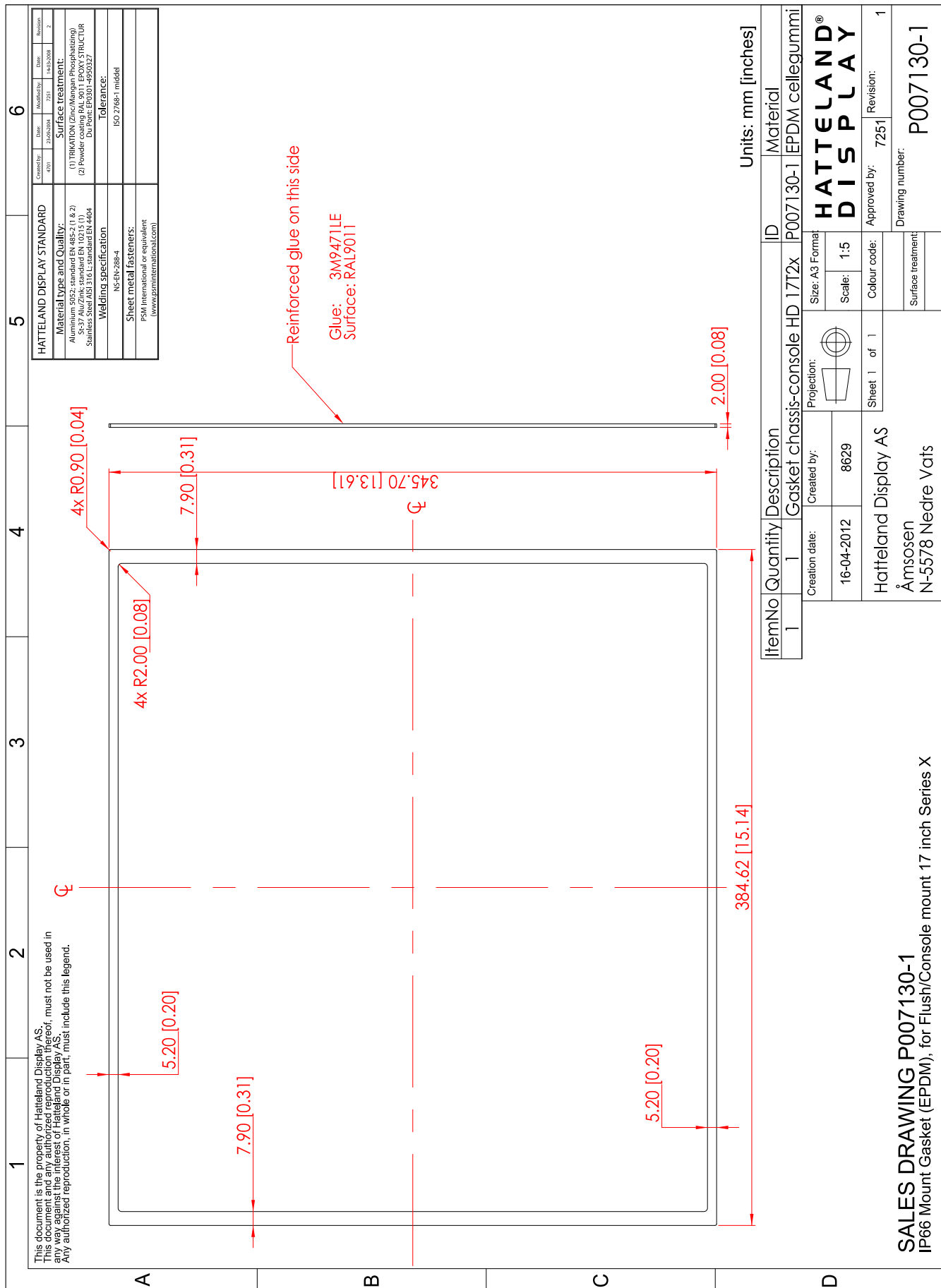

IP66 Panel Gasket (17 inch)

137

This document is the property of Hatteland Display AS. This document and any authorized reproduction thereof, must not be used in any way against the interest of Hatteland Display AS. Any authorized reproduction, in whole or in part, must include this legend. Hatteland Display Proprietary information. Not to be distributed to any third party without written permission.

Technical Drawings - P007131-1

Dimensions might be shown with or without decimals and indicated as mm [inches]. Tolerance on drawings is +/- 1mm. For accurate measurements, check relevant DWG file.

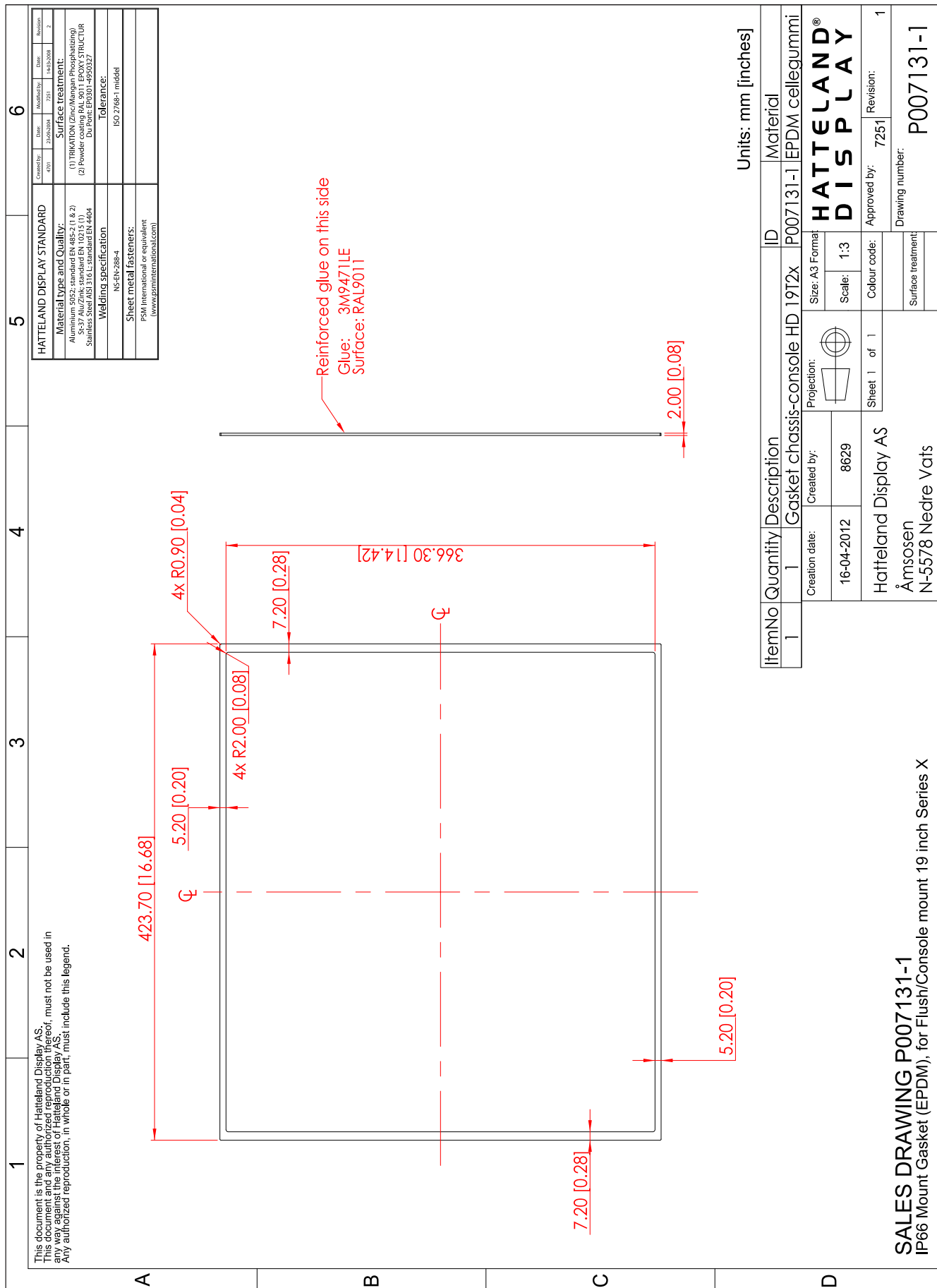

Units: mm [inches]

ItemNo	Quantity	Description	ID	Material
1	1	Gasket chassis-console HD 1912x	P007131-1	EPDM cellegummi
Creation date:		16-04-2012	Size: A3 Format	HATTELAND®
Created by:		8629	Scale:	DISPLAY
Projection:			Colour code:	Approved by: 7251
Sheet 1 of 1		Hatteland Display AS	Revision:	1
Sales Drawing P007131-1		Åmsosen	Drawing number:	P007131-1
IP66 Mount Gasket (EPDM), for Flush/Console mount 19 inch Series X		N-5578 Nedre Vats	Surface treatment:	

This document is the property of Hatteland Display AS. This document and any authorized reproduction thereof, must not be used in any way against the interest of Hatteland Display AS. Any authorized reproduction, in whole or in part, must include this legend. Hatteland Display Proprietary information. Not to be distributed to any third party without written permission.

Technical Drawings - P007032-1

Dimensions might be shown with or without decimals and indicated as mm [inches]. Tolerance on drawings is +/- 1mm. For accurate measurements, check relevant DWG file.

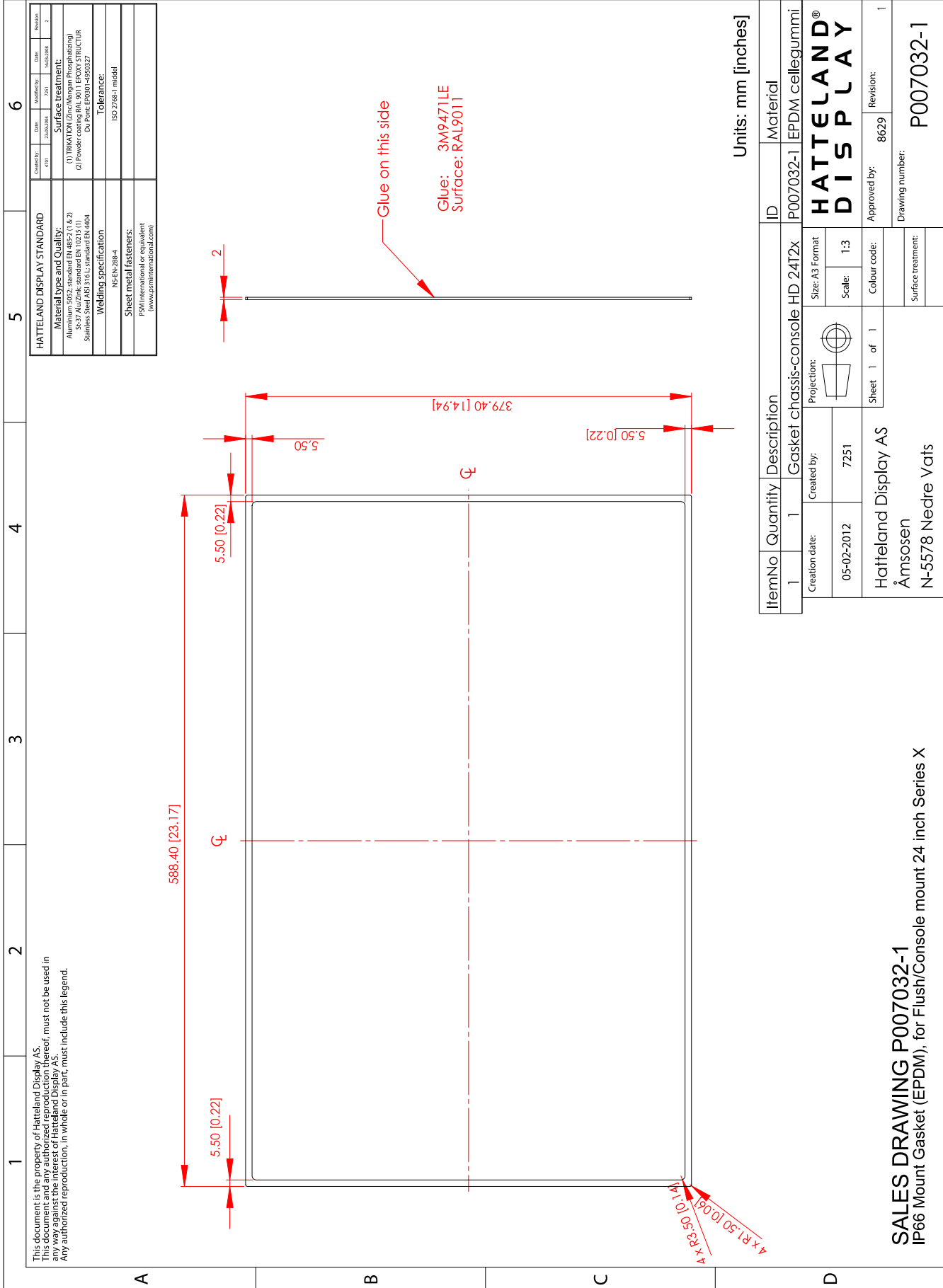

Units: mm [inches]

This document is the property of Hatteland Display AS. This document and any authorized reproduction thereof, must not be used in any way against the interest of Hatteland Display AS. Any authorized reproduction, in whole or in part, must include this legend. Hatteland Display Proprietary information. Not to be distributed to any third party without written permission.

Technical Drawings - P007178

Dimensions might be shown with or without decimals and indicated as +/- 1mm. For accurate measurements, check relevant DWG file.

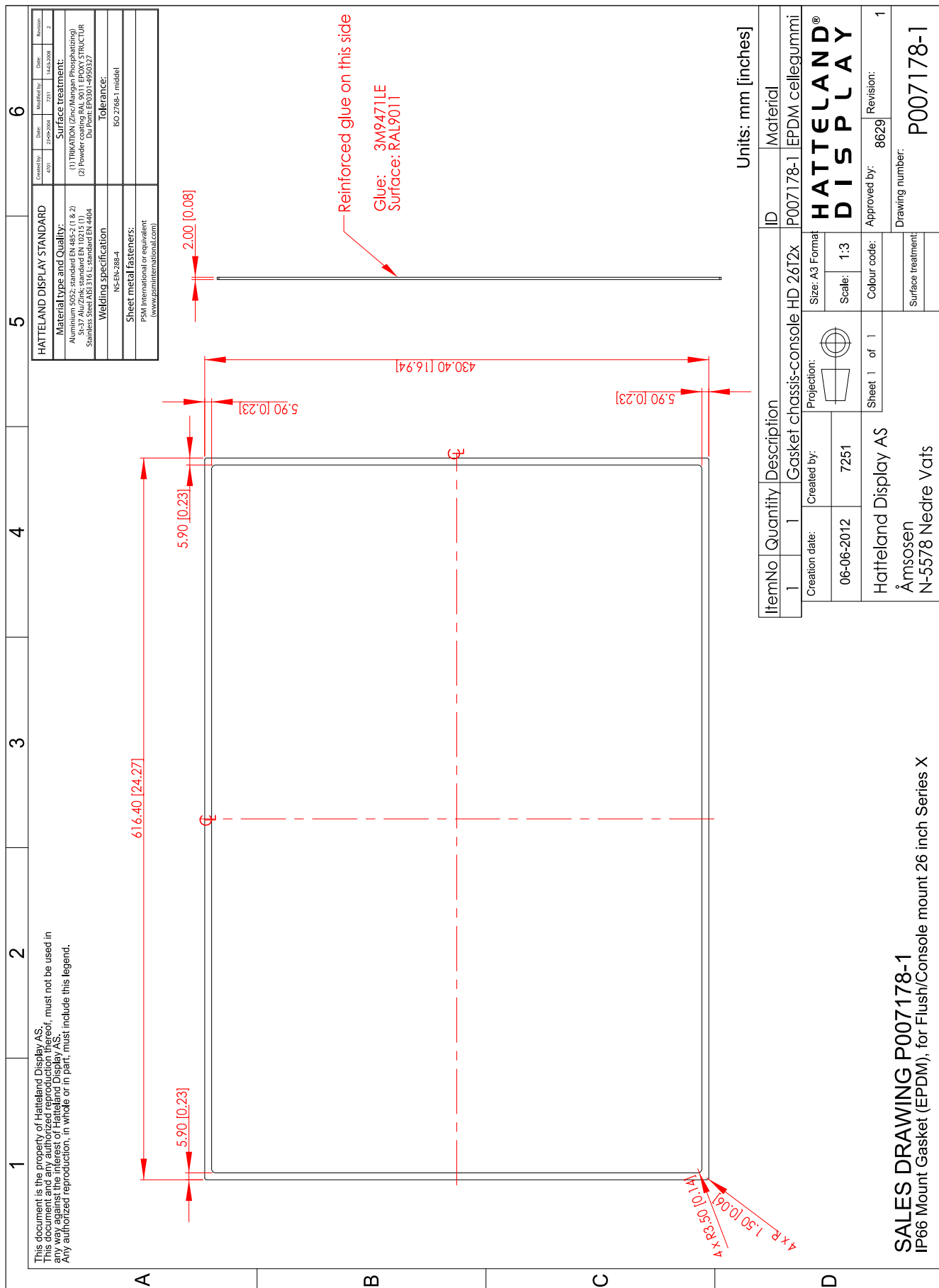

IP66 Panel Gasket (26 inch)

140

This document is the property of Hatteland Display AS. This document and any authorized reproduction thereof, must not be used in any way against the interest of Hatteland Display AS. Any authorized reproduction, in whole or in part, must include this legend. Hatteland Display Proprietary information. Not to be distributed to any third party without written permission.

Dimensions might be shown with or without decimals and indicated as mm [inches]. Tolerance on drawings is +/- 1mm. For accurate measurements, check relevant DWG file.

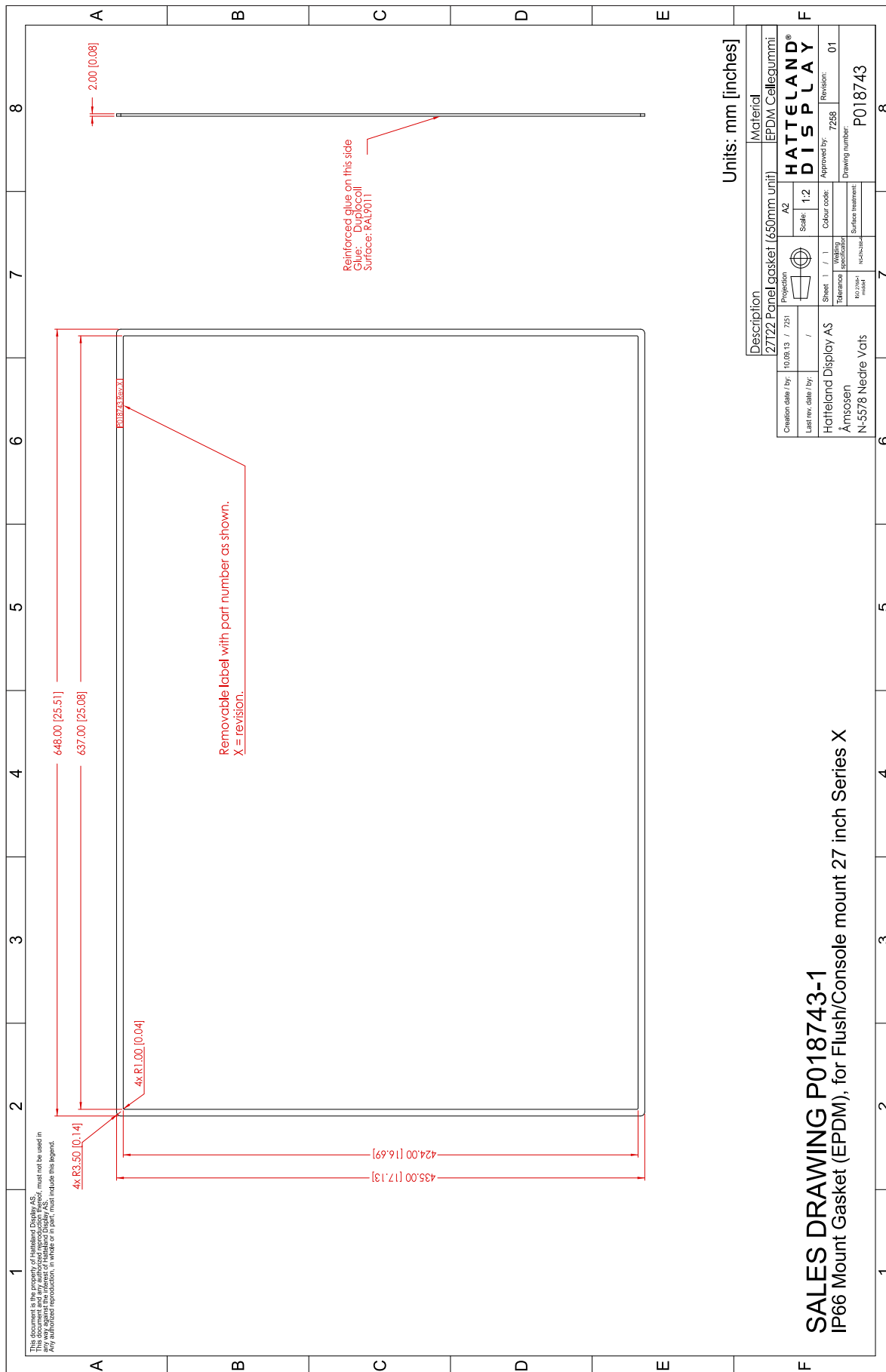

This page left intentionally blank



Appendixes

Pinout Assignments

Connectors illustrated here are either standard by factory default or may be available (through factory customization). Note that some combinations may not be possible due to space restrictions. List also valid for customized models. All pin out assignments are seen from users Point of View (POV) while looking straight at the connector. Please review the dedicated datasheet or technical drawings for your actual unit to identify and determine the presence of desired connector. Detailed information about Housing Connectors (terminal blocks) can be found earlier in this manual.

18/24/24+5 pin DVI-D, DVI-I, Single Link, Dual Link Combined Female

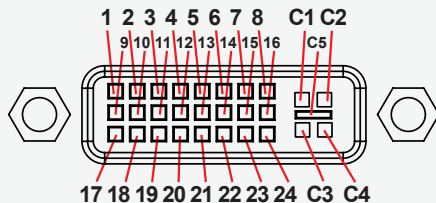

PIN 01	T.M.D.S. Data2 - (Digital - RED link 1)
PIN 02	T.M.D.S. Data2 + (Digital + RED link 1)
PIN 03	T.M.D.S. Data2/4 Shield
PIN 04	T.M.D.S. Data4 - (Digital - GREEN link 2)
PIN 05	T.M.D.S. Data4 + (Digital + GREEN link 2)
PIN 06	DDC Clock
PIN 07	DDC Data
PIN 08	Analog Vertical Sync (DVI-I only)
PIN 09	T.M.D.S. Data1 - (Digital - GREEN link 1)
PIN 10	T.M.D.S. Data1 + (Digital + GREEN link 1)
PIN 11	T.M.D.S. Data1/3 Shield
PIN 12	T.M.D.S. Data3 - (Digital - BLUE link 2)
PIN 13	T.M.D.S. Data3 + (Digital + BLUE link 2)
PIN 14	+5V Power (for standby mode)
PIN 15	Ground (for +5V and analog sync)
PIN 16	Hot Plug Detect
PIN 17	T.M.D.S. Data0 - (Digital - BLUE link 1) and digital sync.
PIN 18	T.M.D.S. Data0 + (Digital + BLUE link 1) and digital sync.
PIN 19	T.M.D.S. Data0/5 Shield
PIN 20	T.M.D.S. Data5 - (Digital - RED link 2)
PIN 21	T.M.D.S. Data5 + (Digital - RED link 2)
PIN 22	T.M.D.S. Clock Shield
PIN 23	T.M.D.S. Clock + (Digital clock + (Links 1 and 2)
PIN 24	T.M.D.S. Clock - (Digital clock - (Links 1 and 2)
PIN C1	Analog RED
PIN C2	Analog GREEN
PIN C3	Analog BLUE
PIN C4	Analog Horizontal Sync.
PIN C5	Analog Ground (return for RGB signals)

DDC = Display Data Channel.

T.M.D.S = Transition Minimized Differential Signal

PIN C1,C2,C3,C4 = Only present on DVI-I connectors.

NOTE: Connector shows a DUAL LINK design, but some units may not support it. Only units with 1920x1200 or more in resolution require / support DUAL LINK.

4-pin USB TYPE A

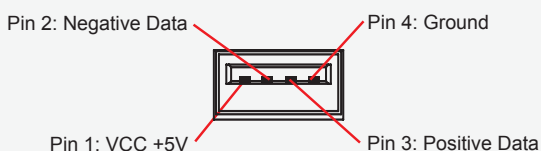

Analog RGB/VGA, 15-pin DSUB High Density Female

Onboard or via DVI-4 adapter

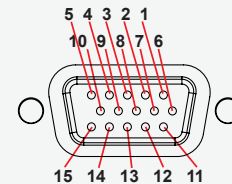

PIN 01	RED	Red, analog
PIN 02	GREEN	Green, analog
PIN 03	BLUE	Blue, analog
PIN 04	ID2/RES	Reserved for monitor ID bit 2 (grounded)
PIN 05	GND	Digital ground
PIN 06	RED_RTN	Analog ground red
PIN 07	GREEN_RTN	Analog ground green
PIN 08	BLUE_RTN	Analog ground blue
PIN 09	KEY/PWR	+5V power supply for DDC (optional)
PIN 10	GND	Digital ground
PIN 11	ID0/RES	Reserved for monitor ID bit 0 (grounded)
PIN 12	ID1/SDA	DDC serial data
PIN 13	HSYNC.	Horizontal sync or composite sync, input
PIN 14	VSYNC.	Vertical sync, input
PIN 15	ID3/SCL	DDC serial clock

1-pin RCA/BNC COMP. VIDEO Female



2-pin DC Power Input.

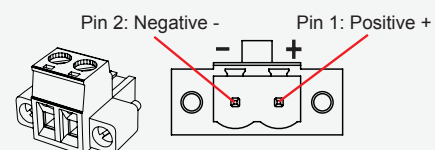

8-pin RJ45 10/100/1000Mbps LAN/Ethernet

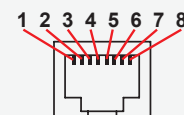

PIN 01	D0P+	Differential Pair 0 (Positive)
PIN 02	D0N-	Differential Pair 0 (Negative)
PIN 03	D1P+	Differential Pair 1 (Positive)
PIN 04	D2P+	Differential Pair 2 (Positive)
PIN 05	D2N-	Differential Pair 2 (Negative)
PIN 06	D1N-	Differential Pair 1 (Negative)
PIN 07	D3P+	Differential Pair 3 (Positive)
PIN 08	D3N-	Differential Pair 3 (Negative)

Pinout Assignments

Potmeter Control, 9-pin DSUB Male

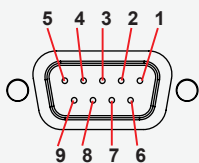

PIN 01	+5V	+5V out
PIN 02	PWR	Power On / Off
PIN 03	Res.	Reserved, do not connect
PIN 04	Aref	For potentiometer
PIN 05	+12V	+12V out
PIN 06	BRT_POT	Potmeter in
PIN 07	BRT -	Button in
PIN 08	BRT+	Button in
PIN 09	GND	Ground

Potentiometer shall be **10kΩ LINEAR**. Connect like the illustrations shown below:

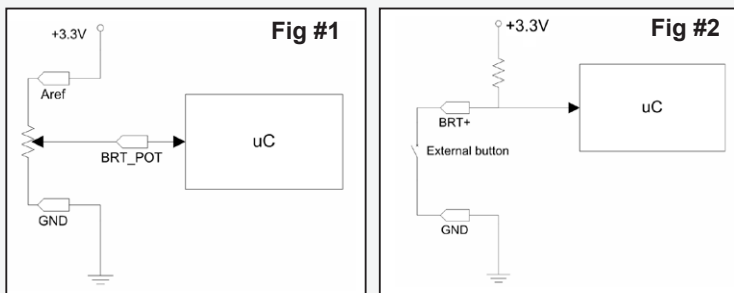

The BRT+ and BRT- can be used for controlling the brilliance by using external buttons. Example for the BRT+ input in figure #2:

Building your own cable:

Note: Requires soldering and assembly. It is expected that the technician has experience in electronics, soldering and assembling cables and connectors.

Pin 1 on product

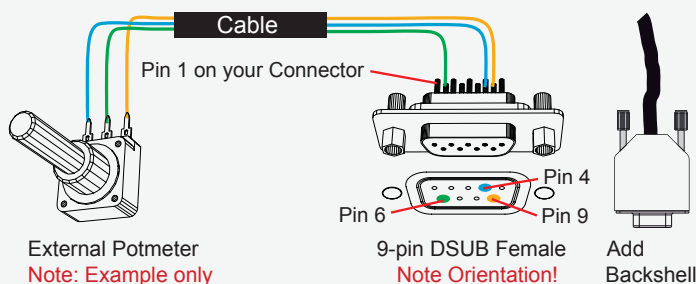

Use a cable that contains at least 3 wires (not 3 single wires). Heat Shrink Tubes must be applied to soldered wire/pins. Test connection (beep) with Voltage Meter. Test connection between power pin and other pins to ensure no short circuit is present prior to connecting cable and power on Display unit. Finally, the 9-pin DSUB must be covered by a back shell.

In order to activate the external potmeter-control, the internal "FHA (Feature Header, Potentiometer)" Serial Command has to be set first via our SCOM (Serial Communication Control Interface).

Usage for SCOM: Review the dedicated Technical Manual available from our website: <http://www.hatteland-display.com/pdfink/inb100018-6.php>

External Power ON/OFF Control, 9-pin DSUB Male

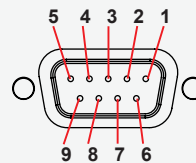

PIN 01	+5V	+5V out
PIN 02	PWR	Power On / Off
PIN 03	Res.	Reserved, do not connect
PIN 04	Aref	For potentiometer
PIN 05	+12V	+12V out
PIN 06	BRT_POT	Potmeter in
PIN 07	BRT -	Button in
PIN 08	BRT+	Button in
PIN 09	GND	Ground

External Power Button must be of "Push Button" type. Instant-On. To turn off unit, Press & Hold down for 3 seconds.

Building your own Push Button for External Power Button:

Note: Requires soldering and assembly. It is expected that the technician has experience in electronics, soldering and assembling cables and connectors.

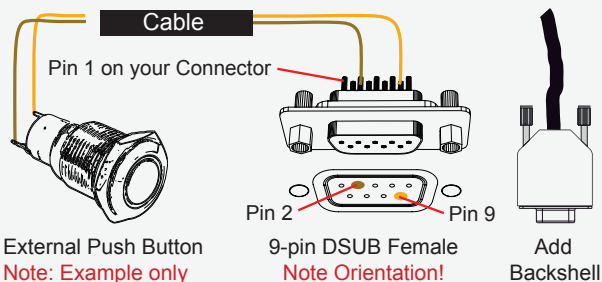

Use a cable that contains at least 2 wires (not 2 single wires). Heat Shrink Tubes must be applied to soldered wire/pins. Test connection (beep) with Voltage Meter.

In order to activate the external Power ON/OFF control it must be enabled:

Via OSD Menu: "OSD Miscellaneous>External Power Button" and set to Enable.
or
Via SCOM (Serial Communication Control Interface):
"MCC" - OSD Control Functionality -> "External Power Button (0x74)".

Usage for SCOM: Review the dedicated Technical Manual available from our website: <http://www.hatteland-display.com/pdfink/inb100018-6.php>

Pinout Assignments

20-pin DisplayPort (DP) Female

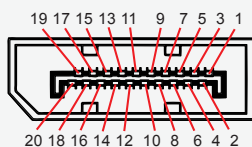

PIN 01	ML_Lane 0 (p) - Lane 0 (positive)
PIN 02	GND - Ground
PIN 03	ML_Lane 0 (n) - Lane 0 (negative)
PIN 04	ML_Lane 1 (p) - Lane 1 (positive)
PIN 05	GND - Ground
PIN 06	ML_Lane 1 (n) - Lane 1 (negative)
PIN 07	ML_Lane 2 (p) - Lane 2 (positive)
PIN 08	GND - Ground
PIN 09	ML_Lane 2 (n) - Lane 2 (negative)
PIN 10	ML_Lane 3 (p) - Lane 3 (positive)
PIN 11	GND - Ground
PIN 12	ML_Lane 3 (n) - Lane 3 (negative)
PIN 13*	CONFIG1 - connected to Ground*
PIN 14*	CONFIG2 - connected to Ground*
PIN 15	AUX CH (p) - Auxiliary Channel (positive)
PIN 16	GND - Ground
PIN 17	AUX CH (n) - Auxiliary Channel (negative)
PIN 18	Hot Plug - Hot Plug Detect
PIN 19	Return - Return for Power
PIN 20	DP_PWR - Power for connector (3.3 V 500 mA)

*Pins 13 and 14 may either be directly connected to ground or connected to ground through a pull-down device. This is the pinout for source-side connector, the sink-side connector pinout will have lanes 0-3 reversed in order; i.e., lane 3 will be on pin 1(n) and 3(p) while lane 0 will be on pin 10(n) and 12(p).

Serial COM RS-232 non-isolated, 9-pin DSUB Female

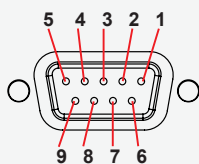

PIN 01**	BUZ+	Buzzer Control Positive*
PIN 02	TxD	Transmit Data
PIN 03	RxD	Receive Data
PIN 04	DTR	Data Terminal Ready
PIN 05	GND	Ground
PIN 06	DSR	Data Set Ready
PIN 07	RTS	Request To Send
PIN 08	CTS	Clear To Send
PIN 09**	BUZ-	Buzzer Control Negative*

*Wake On Ring is not enabled

**See notes in [blue](#).

Series X (G2 - Generation 2) / MVD Series:

- Display Unit needs external power connected to turn buzzer on. (Any logic power state).

10-pin RS-422 / RS-485 Module

"RS-422/RS-485 SCOM + Buzzer"
(Internal Buzzer can be controlled externally)

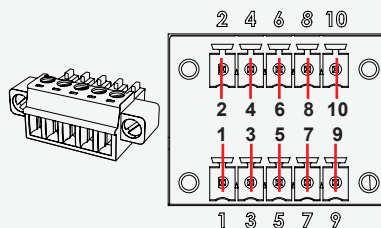

PIN 01*	RxD+	Receive Data Positive
PIN 02	GND	Ground
PIN 03*	RxD-	Receive Data Negative
PIN 04	+5V	+5V Out
PIN 05*	TxD+	Transmit Data Positive
PIN 06**	BUZ-	Buzzer Control Negative
PIN 07*	TxD-	Transmit Data Negative
PIN 08**	BUZ+	Buzzer Control Positive
PIN 09	GNDR	Ground 100Ω
PIN 10	GND	Ground

*Pin 1,3,5,7 = RS-485 Full Duplex (4-wire)

*Pin 5,7 = RS-485 Half Duplex (2-wire)

**See notes in [blue](#).

Basic Trouble-shooting

GENERAL ISSUES FOR TFT PANEL BASED PRODUCTS

Note: Applies for a range of various products. This is only meant as a general guide.

NO PICTURE / LED BEHAVIOUR:

If there is no light at all in the LED at the FRONT, check power cables. If the LED in front is green then check if the brightness is set/adjusted to max brightness. Lack of image is most likely to be caused by incorrect connection, lack of power or wrong BIOS settings.

SCROLLING / UNSTABLE IMAGE:

Signal cable may not be completely connected to computer or TFT display. Check the pin assignments and signal timings of the display and your video card with respect to recommended timing and pin assignments. Make sure that the video card is compatible and that it is properly seated / installed on the computer.

DISPLAY AREA IS NOT CENTERED / SIZED CORRECTLY

Make sure that a supported video mode has been selected on the display, or on the video card / system. If it is impossible to position the image correctly, i.e. the image adjustment controls will not move the image far enough, then test it again using another graphics card for the PC system. This situation may occur with a custom graphics card that is not close to standard timings or if something is in the graphics line that may be affecting the signal, such as a signal splitter (please note that normally a signal splitter will not have any adverse effect). If it is impossible to change to the correct resolution/color depth, check if you have the right graphics driver installed in your system.

IMAGE APPEARANCE:

A faulty TFT panel can have black lines, pixel errors, failed sections, flickering or flashing image. Incorrect graphic card refresh rate, resolution or interlaced mode will probably cause the image to be the wrong size, it may scroll, flicker badly or possibly even no image is present. Sparkling on the display may be a faulty TFT panel signal cable, and it needs service attention.

RGB Signal Only: Horizontal interference can usually be corrected by adjusting the PHASE (OSD menu). Vertical interference can usually be corrected by adjusting the FREQUENCY (OSD menu).

DEW CONDENSATION BEHIND GLASS:

Note that this problem will not occur on bonded products. For non-bonded products, do the following: Power on the TFT product and set brightness to 100%. Turn off any automatic screensavers on PC or similar. During minutes the dew will be gone. To speed up the process, use a fan heater for a reasonable time. Do not overheat the unit.

GENERAL ISSUES FOR COMPUTER BASED PRODUCTS

Note: Applies for a range of various products. This is only meant as a general guide.

CD-ROM FAILURE OR READ/DETECTION PROBLEMS:

If the product are operated/located in a area with extreme condensation, the CD/DVD drive may not work correctly due to condensation on the read head. Keep the product on for a while until it's reached normal operating temperature, and retry accessing discs. Otherwise, consider using USB memory sticks or alternative storage devices.

NO CD-ROM AVAILABLE ON YOUR PRODUCT FOR INSTALLING DRIVERS/SOFTWARE:

Please use USB memory sticks, USB Floppy drive, USB CD-Rom Drive or alternative storage devices to transfer/install software on CD-ROM-less units.

HATTELAND® DISPLAY

an EMBRON Company

Declaration of Conformity

We, manufacturer, **Hatteland Display AS**, Eikeskogvegen 52, N-5570 Aksdal, Norway

declare under our sole responsibility that the
JH MMD, JH MMC, JH STD, JH MIL, HM NMD, HM MIL, HM CMD, HT STD, HD MMD, HM MMD, HT MMC, HD MMC
and HT/HM (computers) product ranges is in conformity with the following standards in accordance with the EMC Directive.

Low Voltage Directive 2014/35/EU
EN 60950:2006/A2:2013

EMC Directive 2014/30/EU
EN 55032:2012 Class A / AC:2011 Class A
EN 55024:2010

Signature:.....

Frode Grindheim

Vice President Product Management
Aksdal, Norway



CE MARK FIRST AFFIXED DATE (11 March 2010)

Signature:.....

Arne Kristiansen

Site Manager - Test & Commission Division
Oslo, Norway

Declaration of Conformity

We, manufacturer, **Hatteland Display AS**, Eikeskogvegen 52, N-5570 Aksdal, Norway
declare under our sole responsibility that the JH MMD, JH MMC, JH STD, JH MIL, HM NMD, HM MIL, HM CMD, HT STD,
HD MMD, HM MMD, HT MMC, HD MMC and HT/HM (computers) product ranges is in conformity with
IEC 60945 4th (EN 60945:2002) and IACS E10 (where applicable)

HATTELAND® DISPLAY

an EMBRON Company

Declaration of Conformity

We, manufacturer, **Hatteland Display AS**, Eikeskogvegen 52, N-5570 Aksdal, Norway

declare under our sole responsibility that the products listed below comply with
FCC 47 CFR Part 15, Subpart B, Class A:

JH MMD, JH MMC, JH STD, JH MIL, HM NMD, HM MIL, HM CMD, HT STD, HD MMD,
HM MMD, HT MMC, HD MMC and HT/HM (computers) product ranges

Note: This equipment has been tested and found to comply with the limits for a Class A digital device, pursuant to part 15 of the FCC Rules.
These limits are designed to provide reasonable protection against harmful interference when the equipment is operated in a commercial
environment. This equipment generates, uses, and can radiate radio frequency energy and, if not installed and used in accordance with the
instruction manual, may cause harmful interference to radio communications. Operation of this equipment in a residential area is likely to
cause harmful interference in which case the user will be required to correct the interference at his own expense.

Signature:.....

Frode Grindheim

Vice President Product Management
Aksdal, Norway



FCC MARK FIRST AFFIXED DATE (16 February 2012)

Signature:.....

Arne Kristiansen

Site Manager - Test & Commission Division
Oslo, Norway

Return Of Goods Information

Return of goods:

(Applies not to warranty/normal service/repair of products)

Hatteland Display referenced as “manufacturer” in this document.

Before returning goods, please contact your system supplier before sending anything directly to manufacturer. When you return products after loan, test, evaluation or products subject for credit, you must ensure that all accessories received from our warehouse is returned. This applies to cables, powermodules and additional equipment except screws or similar, user manual, datasheets or other written paper documents. Furthermore, the product must not have any minor / medium or severe scratches, chemical spills or similar on the backcover, front frame or glass.

This is needed to credit the invoice 100%. Missing parts will not be subject for credit, and you will not get total credit for returned product. You will either be charged separately or the amount is withdrawn from the credit. If you decide to ship the missing items on the after hand, you will get 100% credit for that particular invoice or items received at manufacturer incoming goods control. Please contact our service/sales department if additional questions or review the following links at bottom of page for more information online.



Handling and packing units for return/credit

To prevent damage during shipping and transportation, respect the guidelines below.

Make sure you surround the product with the following material (whenever possible):

Use the original packaging from manufacturer, firm foam material, bubble wrap, lots of PadPack paper or foam chips/polyester wrapped in sealed plastic bags. Please make sure that the unit is protected with a surrounding plastic bag to prevent dust accumulation around the unit.

If you do not have the original packaging or are uncertain how to secure the unit properly, please consider seeking advice from nearby shipping or transportation offices, if in doubt!

Do not under any circumstances use loose foam chips, expanded polyester, clothes, cardboard with sharp edges/spikes, too little or nothing to secure the unit inside the box. Do not use cardboard boxes that are clearly too weak or not suitable for securing the unit properly during overseas shipment.

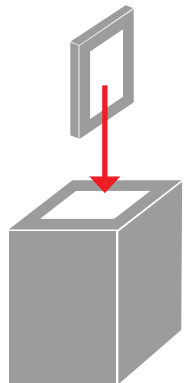

Reference Links:

<http://lcm.hatteland-display.com/CustomerrMA/CustomerrMA.aspx>

http://www.hatteland-display.com/rma_procedure.php

<http://www.hatteland-display.com/terms>

General Terms and Conditions

As of January 2015, Hatteland Display AS' "Terms of Sales and Delivery" and "Warranty Terms" has been substituted by the updated "General terms and conditions for sale of goods and performance of additional services" (the "General Terms and Conditions").

Further, from January 2015 onward, the previous "Terms of Sales and Delivery" and "Warranty Terms", as well as other standard terms and conditions, policies and instructions issued by Hatteland Display AS, will be removed from the User Manuals.

Instead, the updated General Terms and Conditions and the other standard terms and conditions, policies and instructions issued by Hatteland Display AS will be available via our website only.

Please visit <http://www.hatteland-display.com/terms> to review the latest revision of this documentation.

Long Term Storage Recommendations

For Minimum storage life for Hatteland Display products, Storage Conditions, Periodic maintenance - test procedure, please visit: http://www.hatteland-display.com/pdf/misc/ind100350-5_long_term_storage_recommendations.pdf

INSTRUCTIONS FOR THE CONSIGNEE

1) CONTROL

Control the goods immediately by receipt. Examine the quantity towards the invoice/packinglist/shipping documents. Look for outward defects on the packing which may indicate damage on or loss of contents. Control the container and the seals for any defects.

2) SECURING EVIDENCE

When defects on the goods have been found, evidence must be secured, and seller must be informed. Call the transporter and point out the defects. Add a description of the defects on the goods receipt, the forwarder's copy of the way-bill or on the driving slip.

3) RESCUE

Bound the damage. Try to restrict the damage and the loss. Seller will compensate expenses incurred due to reasonable security efforts in addition to damage and loss.

4) COMPLAINT

Write immediately a complaint to the transporter or his agent. Forward immediately the complaint to the transporter or his agent, and hold the transporter responsible for the defects. The complaint must be sent at the latest:

- for carriage by sea: within 3 days
- for overland / air transportation within 7 days

5) DOCUMENTATION

For any claims the following documentation is required, and must be forwarded to the company or their agent: invoice, way-bill and/or bill of lading, and/or statement of arrival, inspection document, besides a copy of the letter of complaint to the transporter.

Pixel Defect Policy

PIXEL DEFECT POLICY

Dot-defects (Bright or dark spots on the panel)

Due to the effect that dot failures are part of the TFT technology such failure occurrence cannot be prevented basically. Even though dot defects usually occur during production process, new defects can appear within the lifespan of a TFT display. Neither the production at LCD-supplier nor the use of a LCD-Monitor after shipment can be influenced by Hatteland Display. Hence Hatteland Display cannot be made responsible for such dot failures. However Hatteland Display understand and accepts the responsibility towards the customers for the delivery of new displays, therefore accepts a limitation on dot defect's occurrence on new displays delivered to the customer.

PRINCIPLES

- a. One pixel consists of 3 dots (Red, Green and Blue)
- b. Dot defects are differentiated between:
 - Bright dot defects: Spot on the panel appear as pixels or sub pixels that are always lit. Non-extinguishing dot.
 - Dark dot defects: Spot on the panel appear as pixels or sub pixels that are always dark (off). Non-lightening dot.
- c. Inspector observes the LCD from normal direction at a distance of 50cm above the worktable. Dark dots are counted under entire white screen. Bright dots are counted under entire black screen.
- d. Dot failures within tolerances below do not qualify for warranty claims.

PIXEL DEFECT TOLERANCES

Bright dot	≤ 4 dots
Two adjacent bright dots *	≤ 2
Distance between 2 dot defects *	≥ 15 mm
Dark dots	≤ 8
Total number of bright or dark dot defects. *	≤ 8

* 1 or 2 adjacent dot defects considered as 1 defect.

EXTRAORDINARY CIRCUMSTANCES

Possible cases which cannot be influenced either by customer or Hatteland Display.

Examples for extraordinary circumstances:

- Allocation from LCD-Supplier
- Outstanding high number of LCD-panels with bright dots but within LCD-suppliers Specification.
- Sharply increased demand by customer

In such cases a mutual agreement is inevitable.

Examples:

- Acceptance of bright dots in "non-critical" display areas.
- Acceptance of bright dots with defined color.

Last Revised July 2007

General Notes:

- The unit is type approved according to EN60945 4th, 4.4, equipment category b) protected from the weather.
- Other type approvals applies for the different products.
Please see the appropriate "Specifications" page in this manual for more information.
- Use of brilliance and Glass Display Control™ (touch key functions) may inhibit visibility of information at night.

Revision History

Rev.	By	Date	Notes
00_01	WJ SE	09 Jun 2017	Release for internal review.
00_02	SE	15 Jun 2017	Added Panel Gaskets
00_03	KK WJ SE	18 Aug 2017	Revised after internal review, added HB models and more accessories
01	WJ KKK BB JE FG SE	23 Oct 2017	Final version 01 for internet release Note: Address changed from "Stokkastrandvegen 87B, N-5578 Nedre Vats" to "Eikeskogvegen 52, N-5570 Aksdal" throughout the manual, reference: http://www.hatteland-display.com/mails/26_2017_pr.html
02	KKK BB PL SE	29 Nov 2017	Added JH 26TAP STD-A1 accessory, page 137 Revised Contents of Package, note "Q1/2018" for HD CMB SX2-E1 / -F1 throughout the manual General update throughout the user manual based on latest specifications and company profile
03	FG SE	20 Dec 2017	Revised "Service Mode OSD", removed "362" wrong code + added note, page 50, 66 General updates performed throughout the user manual based on latest specifications and company profile.
04	VM SE	13 Feb 2018	Removed references to HD CMB SX1-B1 and HD CMB-SX1-C1, now replaced by HD CMB SX2-E1 and HD CMB SX2-F1. Revised Swap Source, only available for PIP, page 61, 65
05	BB FG SE	19 Feb 2018	Corrected errors in Contents of Package (DP cable removed, VGA cable added), page 5
06	BB SE	26 Mar 2018	Revised Contents of Package (USB cable), page 9

Revision History

