

**GLOMEX**<sup>®</sup>  
*The best in marine antennas*



**weBoat<sup>®</sup> 4G Plus**

**DUAL SIM 4G/Wi-Fi INTEGRATED COASTAL  
INTERNET SYSTEM**

**USER AND INSTALLATION MANUAL**

This manual refers to the App weBoat 4G Plus version 1.5 for iOS and Android devices



GL00159

## TECHNICAL SPECIFICATIONS

Antenna dimensions (diam.x H): 250 x 300 mm / 10x12"  
Antenna weight: 1,2 kg / 2,65 lb  
Automatic switch from Wi-Fi registered networks to 4G.  
DUAL SIM Management  
Roaming Management  
4G backup WAN function  
LTE 4G up to 100 Mbps in download and 50 Mbps in upload  
DC-HSPA+ up to 42 Mbps in download and 5.76 Mbps in upload  
3 Ethernet ports  
4 Diversity high performance antennas  
SMS reboot function  
Android and iOS App for an easy control  
Easy installation requires only power supply connection 12/24V  
UV waterproof resistant Dome  
Automatic Firmware upgrade

## General Features

LTE FDD bands: B1/B2/B3/B5/B7/B8/B20  
DC- HSPA+/HASPA+/HSPA/UMTS: 850/900/1900/2100 MHz  
GSM/GPRS/EDGE: 800/850/1800/1900 MHz  
Power Class 3 (23 dBm) for LTE FDD  
Power Class 3 (24 dBm) for UMTS  
Power Class E2 (26 dBm) for EDGE 1800/1900 MHz  
Power Class E2 (27 dBm) for EDGE 850/900 MHz  
Power Class 1 (30 dBm) for GSM/GPRS 1900/1800 MHz  
Power Class 4 (33 dBm) for GSM/GPRS 900/850 MHz

## Data Rates

Mode LTE: DL 100 Mbps - 50 Mbps UL  
DC-HSPA+: DL 43,2 Mbps - 5,76 Mbps UL  
WCDMA PS: DL 384 Kbps - 384 Kbps UL  
EDGE: DL 236,8 Kbps - 236,8 Kbps UL  
GPRS: DL 85,6 Kbps - 85,6 Kbps UL  
Complies with IEEE 802.11b/g/n wireless standard  
Complies with IEEE 802.3 and IEEE 802.3u Ethernet standards

## weBBoat 4G Plus

### General Features - weBBoat 4G Plus US Version

LTE (FDD) bands: B2/B4/B5/B17

DC-HSPA+/HSPA+/HSPA/UMTS bands: 850/1900 MHz

### Data Rates - weBBoat 4G Plus US Version

LTE FDD: Downlink: 100 Mbps, Uplink: 50 Mbps

DC-HSPA+ :Downlink: 42 Mbps, Uplink: 5.76 Mbps

WCDMA: Downlink: 384 kbps, Uplink: 384 kbps

Complies with IEEE 802.11b/g/n wireless standard

Complies with IEEE 802.3 and IEEE 802.3u Ethernet standard

### General Features - weBBoat 4G Plus AUS Version

LTE (FDD) B1/B2/B3/B5/B7/B8/B20/B28, all bands with diversity

DC-HSPA+/HSPA+/HSPA/WCDMA B1/B2/B5/B8, all bands with diversity

EDGE/GPRS/GSM 1900/1800/900/850 MHz

### Data Rates - weBBoat 4G Plus AUS Version

LTE FDD: DL 150 Mbps/UL 50 Mbps @20M BW cat4

DC-HSPA+: DL 42Mbps/UL 5.76 Mbps

HSPA+: DL 21.6 Mbps/UL 5.76 Mbps

WCDMA PS: DL 384 kbps/UL 384 kbps

WCDMA CS: DL 64 kbps/UL 64 kbps

EDGE: DL 236.8 kbps/UL 236.8 kbps

GPRS: DL 85.6 kbps/UL 85.6 kbps

Complies with IEEE 802.11b/g/n wireless standard

Complies with IEEE 802.3 and IEEE 802.3u Ethernet standard

### Federal Communication Commission Interference Statement

This FCC statement is related to weBBoat 4G Plus, for USA market.

This device contains FCC ID: 2AET4-RUT950

This equipment has been tested and found to comply with the limits for a Class B digital device, pursuant to Part 15 of the FCC Rules.

These limits are designed to provide reasonable protection against harmful interference.

This equipment generates, uses and can radiate radio frequency energy and, if not installed and used in accordance with the instructions, may cause harmful interference to radio communications. However, there is no guarantee that interference will not occur in a particular installation.

FCC Caution: Any changes or modifications not expressly approved by the party responsible for compliance could void the user's authority to operate this equipment. This device complies with Part 15 of the FCC Rules. Operation is subject to the following two conditions: (1) This device may not cause harmful interference, and (2) this device must accept any interference received, including interference that may cause undesired operation.

This device and its antennas must not be co-located or operated in conjunction with any other antenna or transmitter.

**IMPORTANT:** Exposure to Radio Frequency Radiation.

142 cm minimum distance to general public. Under such configuration, the FCC radiation exposure limits set forth for a population/uncontrolled environment can be satisfied.

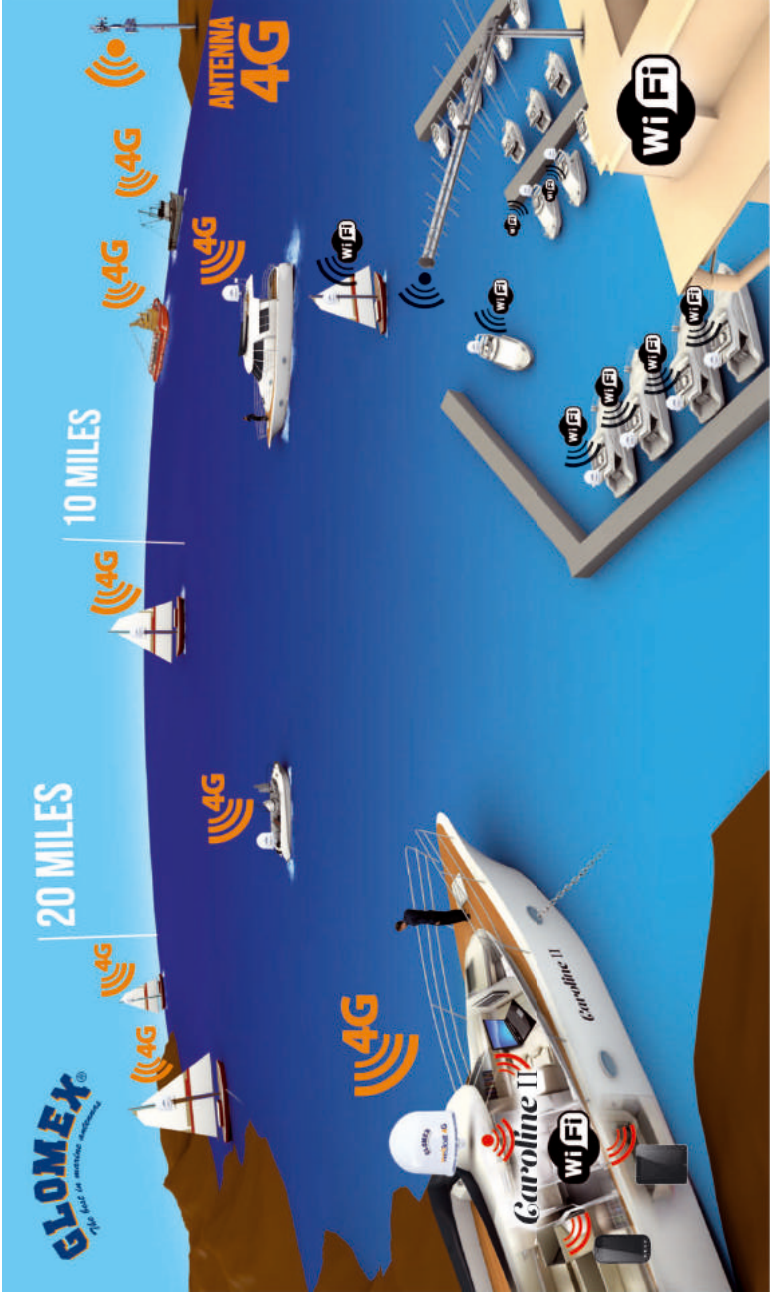

weBoat® 4G Plus

4G 2G  
UMTS  
3G GPRS

SMARTPHONE - TABLET - COMPUTER

SOCIAL NETWORK AND MAIL

# INDEX

1.	FOREWORD . . . . .	51
1.1	INTRODUCTION . . . . .	51
1.2	IDENTIFICATION weBBoat 4G Plus . . . . .	51
1.3	WARRANTY . . . . .	51
1.4	GENERAL SAFETY RULES . . . . .	53
1.5	ENVIRONMENT . . . . .	53
2.	PRODUCT DESCRIPTION . . . . .	54
3.	CONTENTS . . . . .	56
3.1	INSTALLATION . . . . .	57
3.2	INSERTING THE SIM CARDS . . . . .	61
4.	HOW TO DOWNLOAD CONTROL APP FOR weBBoat 4G Plus . . . . .	62
5.	FIRST TIME SETUP . . . . .	64
5.1	SIM 1 CONFIGURATION . . . . .	67
5.2	ALTERNATIVE APN CONFIGURATION . . . . .	67
5.3	SIM 2 CONFIGURATION . . . . .	69
5.4	CONTROL UNIT . . . . .	70
6.	OPTIONS BUTTON . . . . .	78
6.1	Wi-Fi SETTING . . . . .	79
6.2	CHANGE ADMINISTRATOR PASSWORD . . . . .	82
6.3	MANUAL IP CONFIGURATOR . . . . .	83
6.4	RESTART ROUTER . . . . .	84
6.5	RESET ROUTER . . . . .	84
6.6	FACTORY RESET . . . . .	84
7.	UPDATING FIRMWARE AND SETTINGS BACKUP . . . . .	86

## **1. FOREWORD**

### **1.1 INTRODUCTION**

Thank you for purchasing the Glomex weBBoat 4G PLUS. We are sure that you will enjoy the quality and reliability of this device for many years to come.

This user manual should be read thoroughly before attempting to install the device to ensure trouble-free operation. If you are unsure in any aspect of this installation, please contact a qualified technician or Glomex Customer Service.

### **1.2 IDENTIFICATION weBBoat 4G Plus**

For any communication with Glomex or its service center, please have the model and serial number of the weBBoat 4G PLUS handy which can be found on the outside packaging, page one of this manual, or on the router inside the weBBoat housing.

### **1.3 WARRANTY**

Glomex guarantees the weBBoat 4G PLUS (IT1004PLUS) against manufacturing defects for a period of 2 years from date of purchase. Warranty can be in the form of repair or replacement of the unit if manufacturing defects have been found and are confirmed by Glomex or one of its affiliates. In order to validate warranty, either the original sales receipt or a copy must be provided at the time warranty is requested.

Before returning any items for warranty, please contact the Glomex Customer Service department to receive a RMA which should be completed and sent with the unit to the following address:

**GLOMEX S.r.l.**  
**Via Faentina 165/G**  
**48124 Ravenna (Italy)**

complete with all the accessories supplied at the time of purchase for shipment.

The serial number must neither be erased nor made illegible, otherwise the warranty will be voided.

### **WARNING**

---

Retain this user manual and installation guide which contains you serial number for warranty purposes.

---

## weBBoat 4G Plus

The warranty does not apply in case of damage due to carelessness, use or installation not compliant with the instructions given, tampering, product or serial number modification, damage due to accidental causes or to the buyer's negligence.

Moreover, warranty does not apply in case of damage consequent to connections of the equipment to different voltages than those indicated or to sudden voltage variations of the network the equipment is connected to, as well as in case of damage caused by leakage, fire, inductive/electrostatic discharges or discharges due to lightning, use of cables different to those provided, overvoltages or other phenomena not related to the equipment.

**Finally, the warranty does not apply to problems caused by the telephone operator and at a Wi-Fi hotspot.**

**The guarantee is not applicable in case passwords are lost. Keep them in a safe place.**

The parts subject to wear consequent to use such as connection cables, connectors, external parts and plastic supports are covered by a one-year period warranty.

The following are not covered by warranty: periodic monitoring, software updates, settings of the product, maintenance.

After the expiration of the warranty period, the technical support activities will be carried out charging the customer for the replaced parts, the labour costs and freight charges, according to current rates.

**The equipment will be replaced or repaired under warranty only and exclusively on Glomex quality department's approval.**

Should any dispute rise, the place of jurisdiction will exclusively be Ravenna (Italy).

The warranty is provided by:

**GLOMEX S.r.l.**  
**Via Faentina 165/G**  
**48124 Ravenna (Italy)**

## 1.4 GENERAL SAFETY RULES

Carefully read the instructions and follow the recommended precautions to avoid potential hazards and safeguard your health and safety, before carrying out any installation and maintenance. This manual contains the following indications:



---

This symbol warns against potential damage to the equipment which could involve the operator's safety.

---

Failure to comply with the instructions preceded by the above-mentioned keywords (WARNING) can cause serious accidents or even the death of the persons involved.

Moreover, in this Manual, some instructions are given with text in italics, preceded by the word NOTE.

The information and specifications given in this manual are based upon the information available at the moment it is written.

In case of doubts, do not hesitate to contact GLOMEX S.r.l. at the following email:

service@glomex.it

## 1.5 ENVIRONMENT

Do not throw the appliance away with the normal household waste at the end of its life, but instead, dispose of at a recycling station. By doing this, you will help preserve the environment.



Fig. 1

GL00024



### 2. **PRODUCT DESCRIPTION**

weBBoat 4G Plus is the first unique award-winning 3G/4G/Wi-Fi DUAL SIM integrated system designed by Glomex to surf the Internet at high speed, ensuring stable and fast connections up to 20 miles away from the coast.

weBBoat 4G Plus has 2 ea. 4G Diversity antennas and 2 ea. Wi-Fi antennas that receive the Internet signal and redirect it inside the boat, thereby increasing the signal strength, with a secure and protected Wi-Fi network that can be used simultaneously by upto 32 different connected devices. Also, if a known Wi-Fi network is present and available (such as the local marina's network), weBBoat 4G Plus will automatically connect to it to limit the cost of the Internet connection.

weBBoat 4G PLUS is a PLUG & PLAY product as the 4G GSM module is integrated within the radome and, for its operation, it only requires a 12 to 24 Volt power cable (12 VDC or 24 VDC) and one/two SIM cards from any worldwide telephone operator\* for surfing the Internet; all this makes the system particularly easy to install. weBBoat 4G Plus is also easy to use, due to the new weBBoat 4G Plus free app available for iOS and Android devices.

**NOTE: The distance from the coast within which the weBBoat 4G Plus works depends on the 3G/4G signal coverage from the transmitter of your cellular carrier, the correct installation of the weBBoat, and on the height of the weBBoat antenna.**

#### **New functions:**

- Free and automatic firmware updates with the possibility to back up system settings
- Periodic and free App updates
- Technical assistance via APP

weBBoat 4G Plus is provided with:

- 2 high-gain and wide bandwidth antennas to transmit and receive in 3G and 4G in a Diversity configuration;
- 2 Wi-Fi antennas to receive the Wi-Fi signal of the local Wi-Fi network, thus limiting the costs of surfing the Internet; The 2 antennas are able to receive the Wi-Fi signal from twice the distance of the previous version;
- Automatic 4G/Wi-Fi switching with default to Wi-Fi to save on connection charges;
- Automatic SIM card switching to reduce roaming costs;
- 1 3G/UMTS, 4G/LTE, LAN and Wi-Fi router to redistribute the Internet signal to a maximum of 32 devices (PCs, smartphones and tablets) present on the boat through the protected and secure weBBoat 4G Plus Wi-Fi network;
- External slot for 2 Micro-SIM cards with locking system.

Simply insert one or two Micro-SIM cards (not supplied) into the convenient external card slots and you can connect all of your Internet devices (smart-phone, tablet, PC, etc) to a 3G/4G network or the local Wi-Fi hotspot. The small internal router (250mm/10" x 300mm/12") will automatically switch from 3G/4G to Wi-Fi and back to maintain internet connection. weBBoat 4G Plus, in fact, can disable international roaming (if correctly set), as described on page 74 (disable roaming).

To avoid excessive costs, we recommend using the Micro-SIM card of the country in which you are navigating\*.



**Fig. 2**

GL00222

\* **NOTE:** For correct 4G operation, please verify that your service provider is operating on the LTE network as listed on page 3 of this manual.

### 3. CONTENTS

The weBBoat 4G PLUS is packed and shipped in a sturdy cardboard box and sealed with Glomex tape to eliminate damage or tampering.

Upon receipt, please check that:

- the packaging is not damaged and the Glomex packing tape is intact.
- the item matches that which was ordered.
- there is no internal damage to the antenna.
- the label with the serial number is present on the antenna. There is also a label on page 1 of this manual.

In case of damage or missing parts, immediately inform the Retailer, if possible with appropriate photos.

The components contained in the packaging are the following:

- Antenna unit (Fig. 3)
- Quick Reference Guide (Fig. 4)
- Installation and Operating Manual (Fig. 5) - If not present, the manual can be downloaded from the website [www.glomex.it/weBBoat](http://www.glomex.it/weBBoat), technical support section



Fig. 3

GL00223

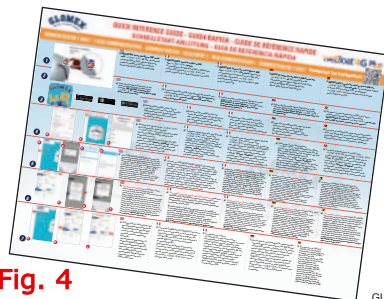

Fig. 4

GL00230



Fig. 5

GL00224

### 3.1 INSTALLATION

#### Installation on sailboats

It is advisable to place the weBBoat 4G Plus to a maximum height of 8/10 meters on the spreader with the support Glomex code ITM001 (not supplied).

The weBBoat 4G Plus must be fixed to the support by tightening the screw on the bottom of weBBoat 4G Plus with a screwdriver (Fig. 7).

**IMPORTANT:** Do not install the weBBoat 4G Plus at the masthead.

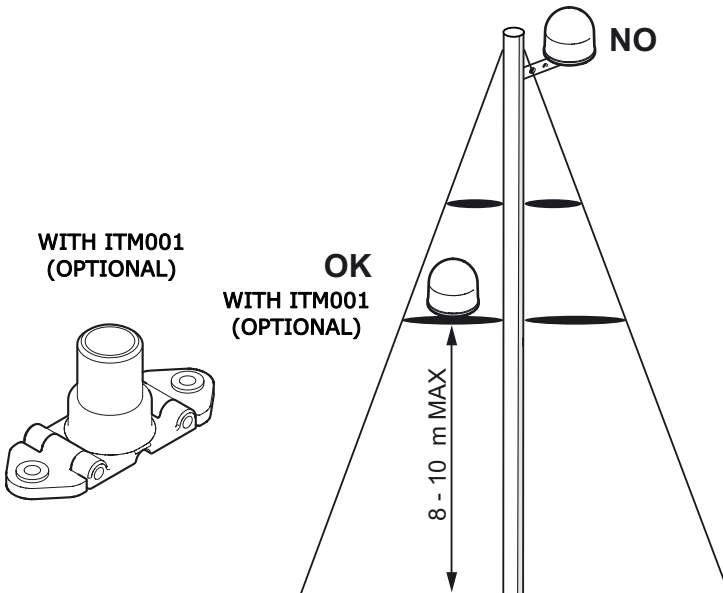

Fig. 6

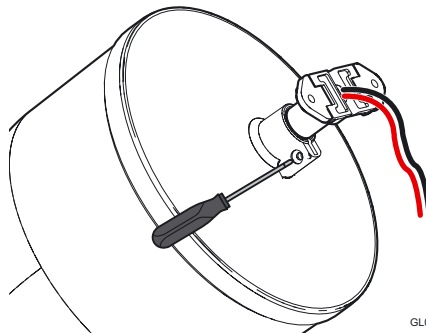
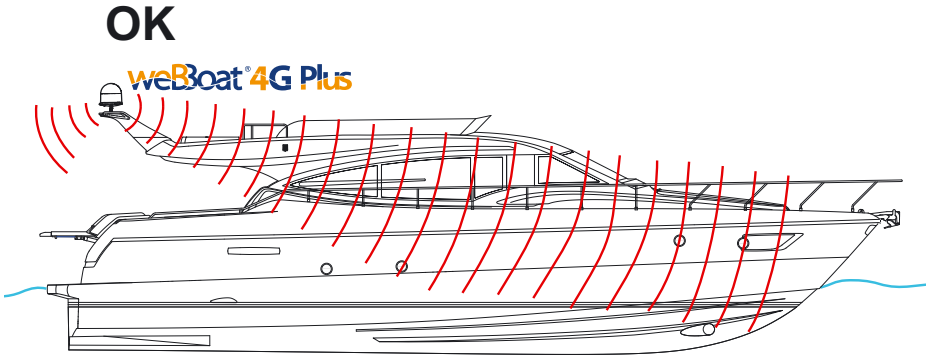

Fig. 7

Typical installation on fiberglass power boats



GL00231

Fig. 8

Typical installation on metal power boats

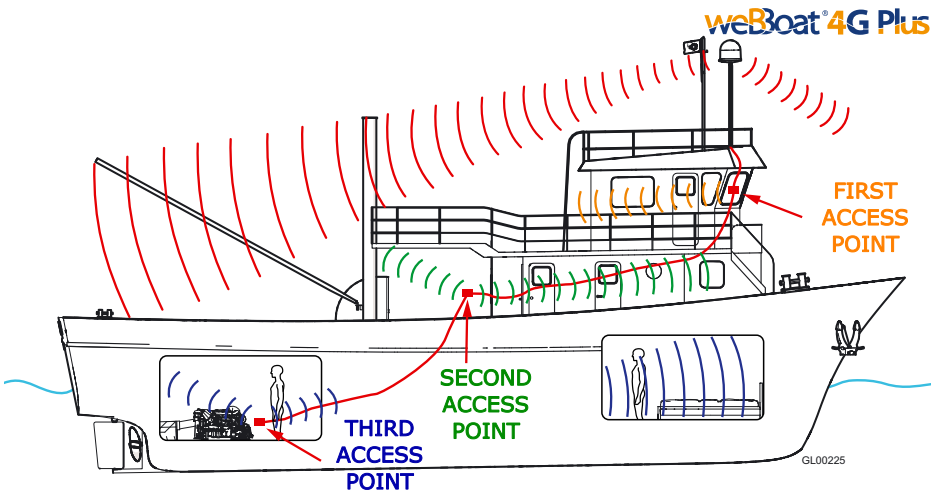

Fig. 9

Note: Up to 4 access points can be connected to the weBBoat 4G PLUS for complete coverage inside a metal vessel.

**Warning:**

- The weBBoat 4G Plus must be fixed to a mount by tightening the screw in the base of the weBBoat 4G Plus by means of a screwdriver (Fig. 7).
- The installation of the weBBoat 4G Plus near or above a flat metal surface may result in significant reduction of the Wi-Fi and 3G/4G signal strength.
- Do not mount the weBBoat 4G Plus near metal obstructions that may interfere with the Wi-Fi signal.

When using the weBBoat 4G PLUS on metal vessels, Wi-Fi signal can be very weak. For this reason, it is necessary to use an access point (maximum of 4 APs can be used) inside the vessel. These can be connected to an external network hub (optional) which then connects to the router inside the weBBoat 4G PLUS radome via an Ethernet cable (optional) (Fig. 10).

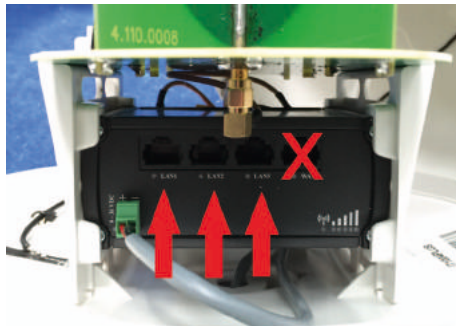

**Fig. 10**

GL00236

**Electric connections**

For proper functioning of weBBoat 4G Plus, simply connect the antenna power cable to a 12/24 Vdc source following the guidelines below. Connect the red (positive) and the black wire (negative) coming out from the base of weBBoat 4G Plus to the battery through a twin lead power cable. The connection can be made by soldering or with a crimp sleeve. It is advisable to have this procedure carried out by a technician.

**IMPORTANT:** Incorrect connection or reverse polarity on the power supply will blow the internal fuse of the weBBoat 4G PLUS.

**The power line (not supplied) which connects the two wires coming out from the base of weBBoat 4G Plus must have cables with a cross section of 1.5 mm<sup>2</sup> by a length up to 10 m, and 2.5 mm<sup>2</sup> for longer lengths. Minimum power supply voltage: 9Vdc.**

**NOTE:** To prevent boat battery drain, we recommend attaching the weBBoat power supply to a fuse panel that can be turned off when the unit is not in use.

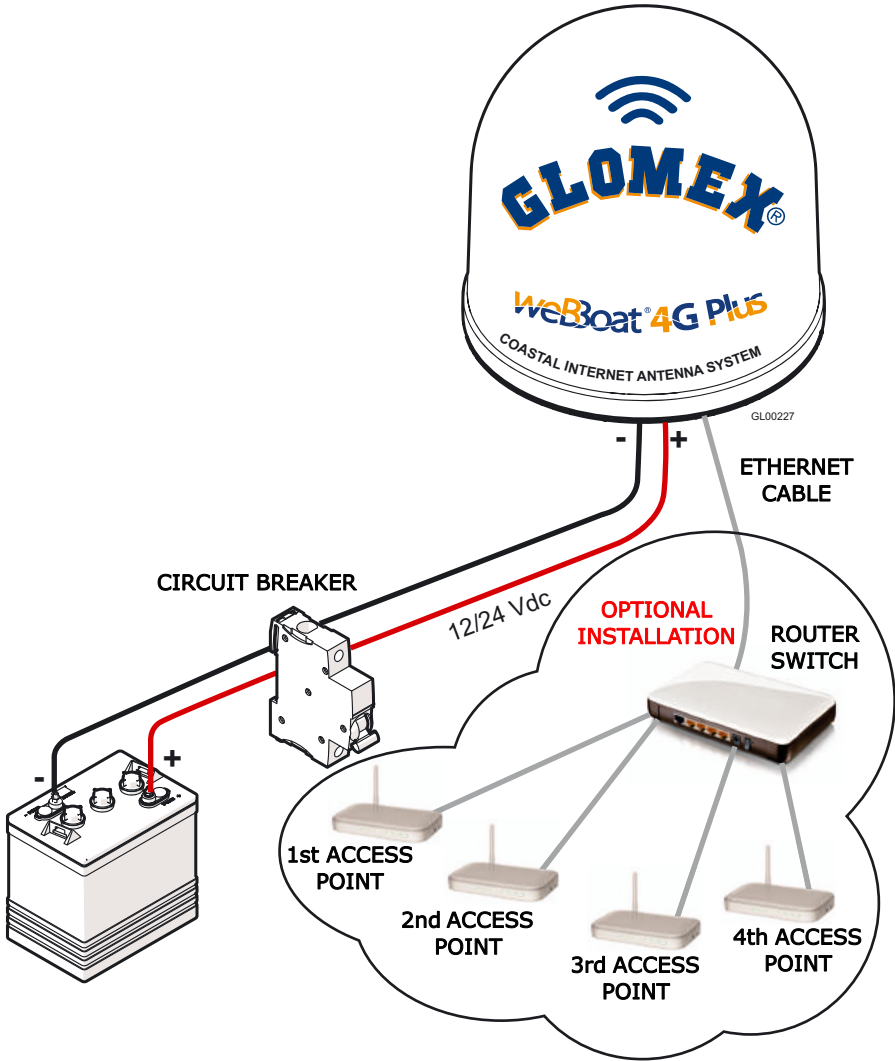

**Fig. 11**

**NOTE:** In order to receive the signal from the weBBoat inside metal vessels, up to a maximum of four access points (according to your needs) must be placed inside the boat, which must be linked with a switch to the router inside the weBBoat 4G Plus via an Ethernet network cable.

## 3.2 INSERTING THE SIM CARDS

**NOTE:** Insert the micro-SIM card(s) with weBBoat 4G Plus off.

Insert the two Micro-SIM cards in the dedicated external slots with the cut edge facing down and the contact facing outwards, as shown in Fig. 12.

**NOTE:** If you use weBBoat 4G Plus with a single Micro-SIM card, it must be inserted in slot 1.

### ⚠ WARNING

**SWITCH OFF weBBoat 4G Plus BEFORE INSERTING THE SIM CARD.**

**IMPORTANT:** If the SIM card has a PIN, we recommend to remove the PIN code request before inserting the SIM card into weBBoat 4G Plus. This can be done via a mobile phone and varies according to the individual mobile phones. Please check the steps in the instructions of your mobile phone, or contact your carrier.

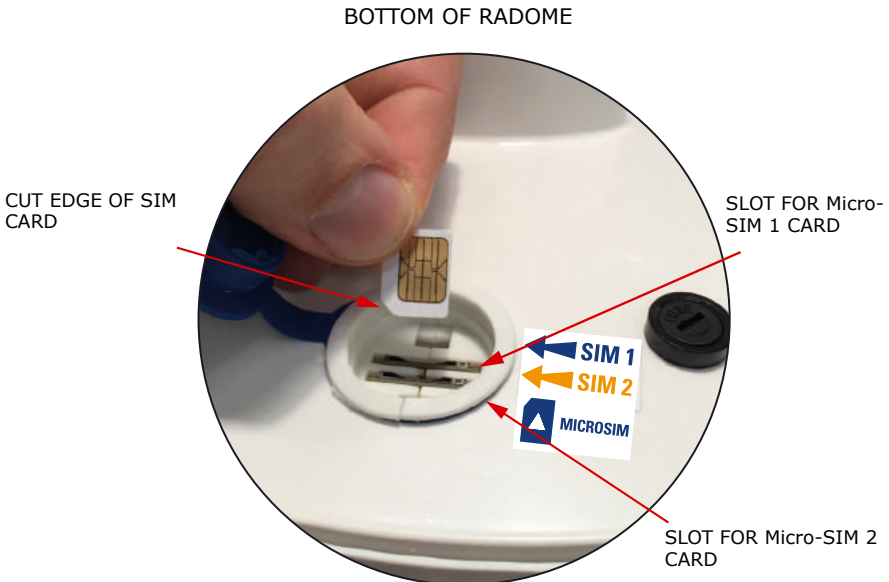

GL00228

**Fig. 12**



#### 4. HOW TO DOWNLOAD CONTROL APP FOR weBBoat 4G Plus



To control your weBBoat 4G PLUS, you must download the weBBoat 4G PLUS app from the App Store for Apple devices or from the Play Store for Android devices.

**NOTE:** since we mention Apple and Android, we will need to put the usage statement about them in here as well.

The weBBoat 4G Plus App is essential to setup weBBoat 4G Plus.



Fig. 13

GL00229

**IMPORTANT:** The app instructions should be used only by the weBBoat 4G Plus administrator (using only one device). After following all the steps in the following instructions, all the other internet devices (up to 31) must simply select the Wi-Fi network of the webboat and enter the password, if required.

After the download, activate the Wi-Fi connection, then connect to the weBBoat 4G Plus. The weBBoat 4G Plus network is called "Glomex\_weBBoat" (Fig. 14).

Please note YOU MUST CONNECT YOUR IOS OR ANDROID DEVICE TO THE WI-FI NETWORK OF THE WEBBOAT AND NOT TO THE HARBOR, OFFICE NETWORK OR OTHERS.

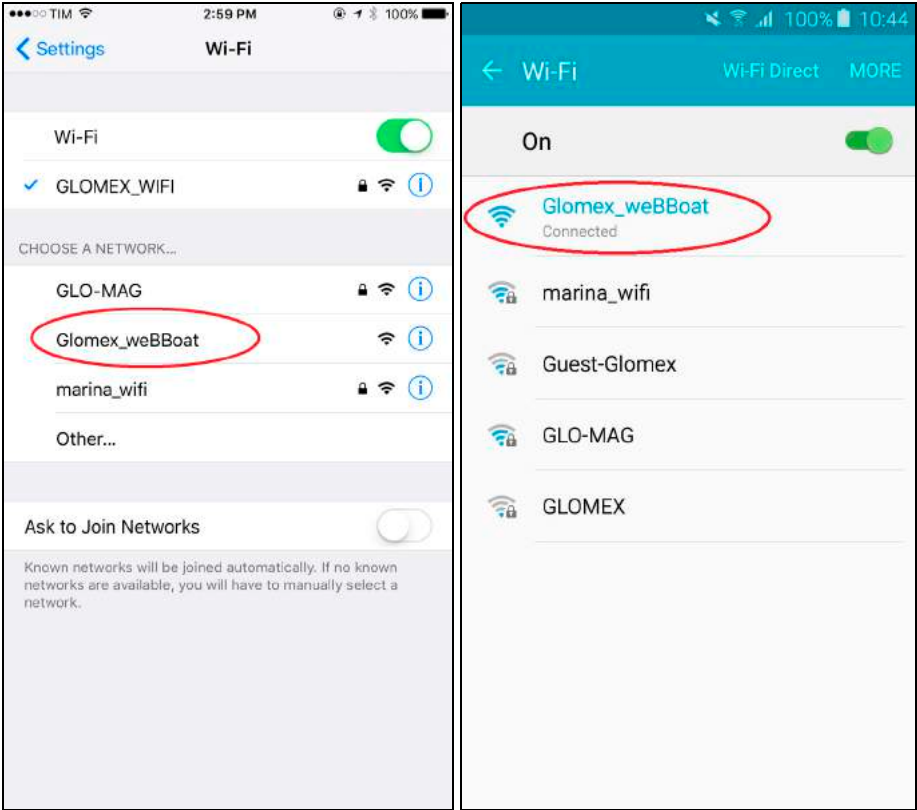

iOS

Android

Fig. 14

## weBBoat 4G Plus

### 5. FIRST TIME SETUP

Check that your device (Smartphone or Tablet) is connected to the "Glomex\_weBBoat" Wi-Fi network.

**NOTE** the weBBoat 4G Plus Wi-Fi network has no password. It is recommended to change the network name and password after the initial settings (see page 82 - point 6.2).

Open the weBBoat 4G Plus App and select the menu button on the top left (Fig. 15).



Fig. 15

GL00239

Select **CONTROL PANEL** (Fig. 16), enter the administrator's password **admin01**, then press OK in the iOS version or press Connect in the Android version (Fig. 17).

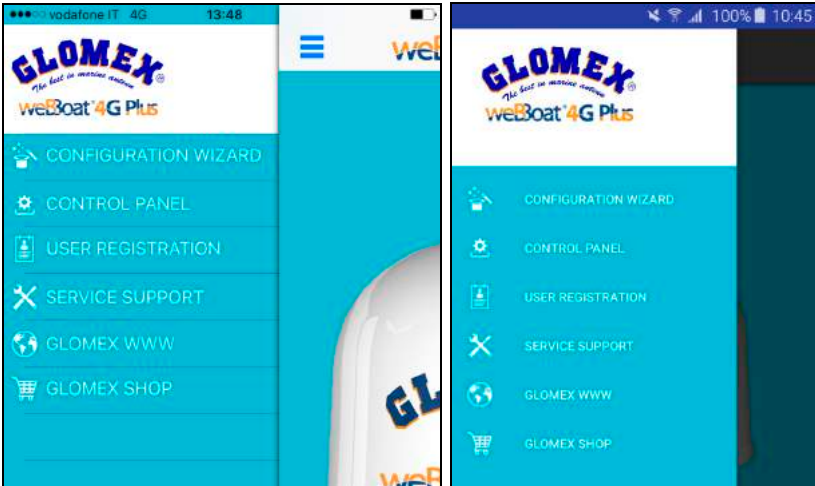

Fig. 16

iOS

Android

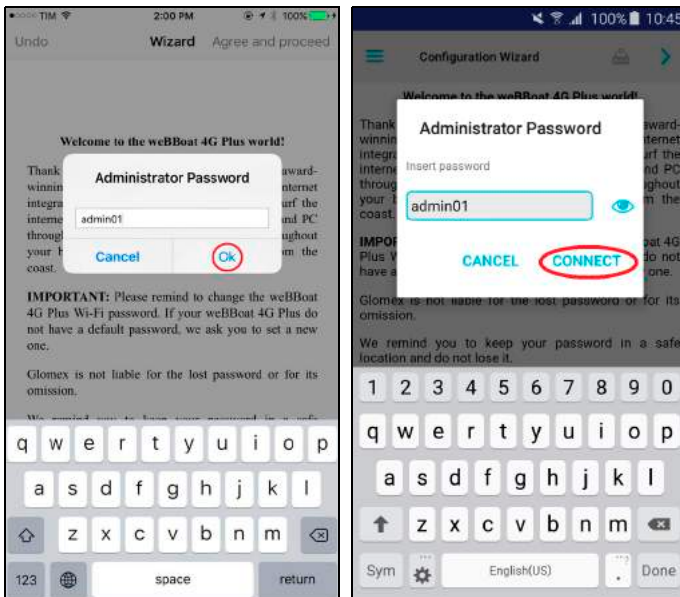

Fig. 17

iOS

Android

## weBBoat 4G Plus

Read the informative note and press **Agree** and **proceed** in the iOS version or press the arrow in the Android version (Fig. 18).

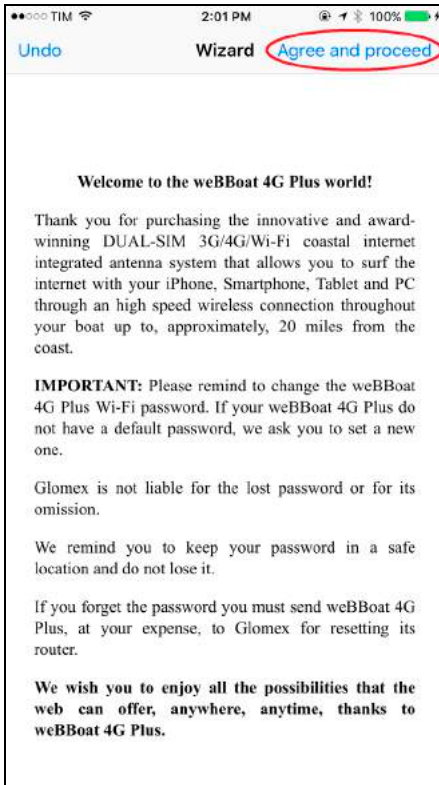

iOS

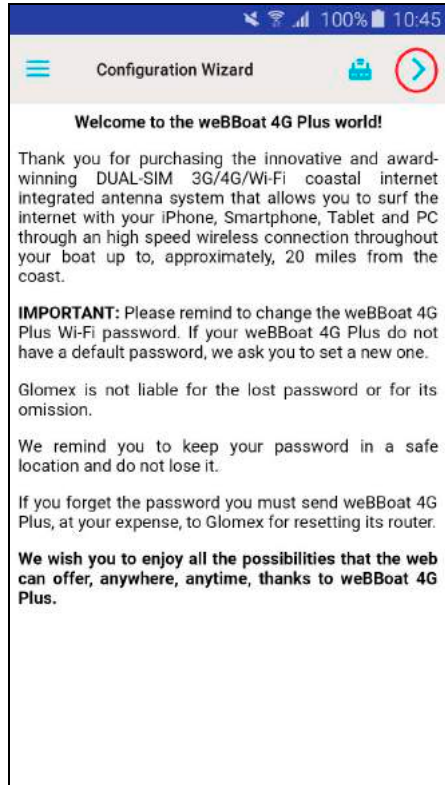

Android

Fig. 18

The SIM 1 configuration window will then appear.

## 5.1 SIM 1 CONFIGURATION

If the protection PIN is in the SIM card, enter it in the SIM Pincode 1 field. Then select the country corresponding to the SIM card carrier, select the telephone carrier and press **Next** or press the arrow in the Android version (Fig. 19).

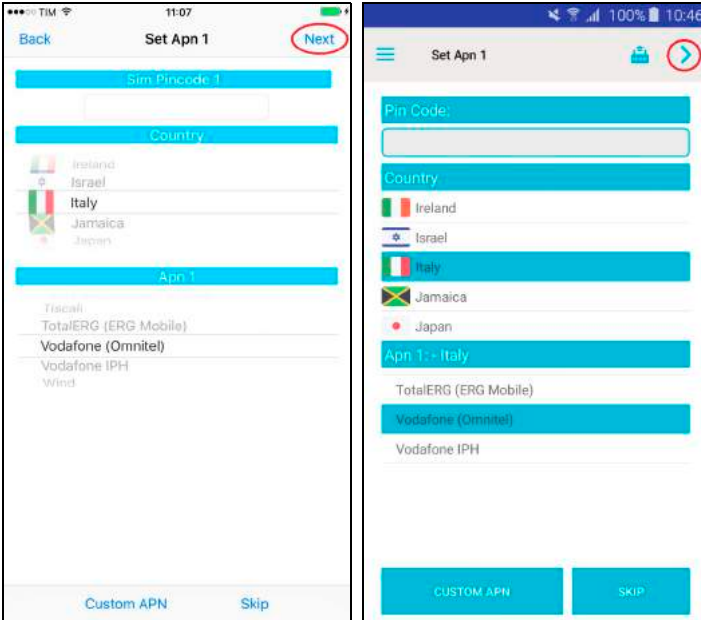

Fig. 19

iOS

Android

## 5.2 ALTERNATIVE APN CONFIGURATION

If your telephone operator is not on the list, select **Custom APN** in the iOS version or **CUSTOM APN** in the Android version (Fig. 20).

Fill in the requested fields (Fig. 21):

- Provider: Name of the telephone carrier
- APN: Check the correct APN according to your data plan with your telephone carrier
- Username: Fill in if required by the settings communicated by the telephone carrier
- Password: Fill in if required by the settings communicated by the telephone carrier

Press **Save custom APN** in the iOS version or **Save setting** in the Android version.

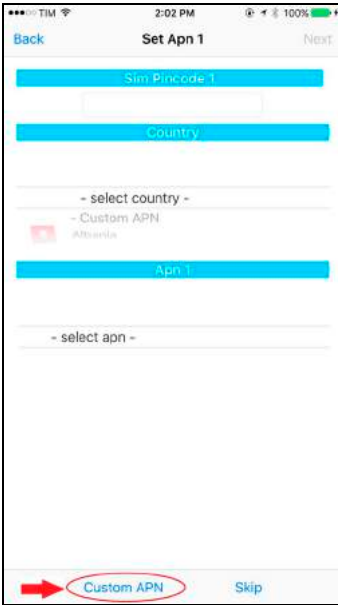
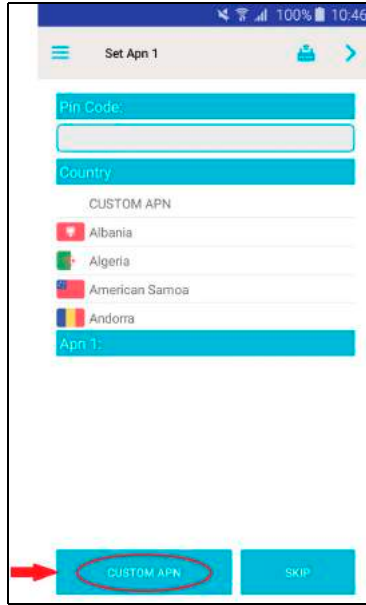

Fig. 20

iOS



Android

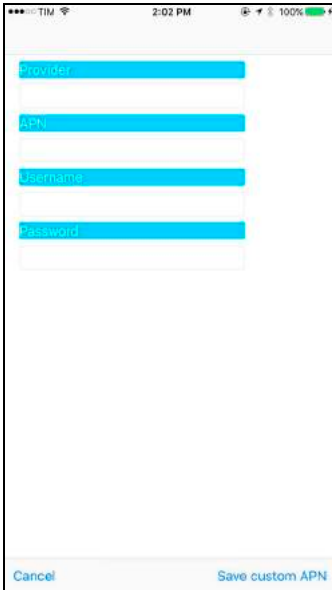

Fig. 21

iOS



Android

### 5.3 SIM 2 CONFIGURATION

Follow the same procedure as SIM 1 Configuration if you have a second SIM. If a second SIM is not present, continue pressing SKIP.

At this point a screen summarizing the choices made will be displayed; now press **Save** in the iOS and Android version (Fig. 22).

Wait about 1 minute and check the device settings to make sure it is connected to the weBBoat 4G Plus Wi-Fi network. Launch the App again and enter the control panel.

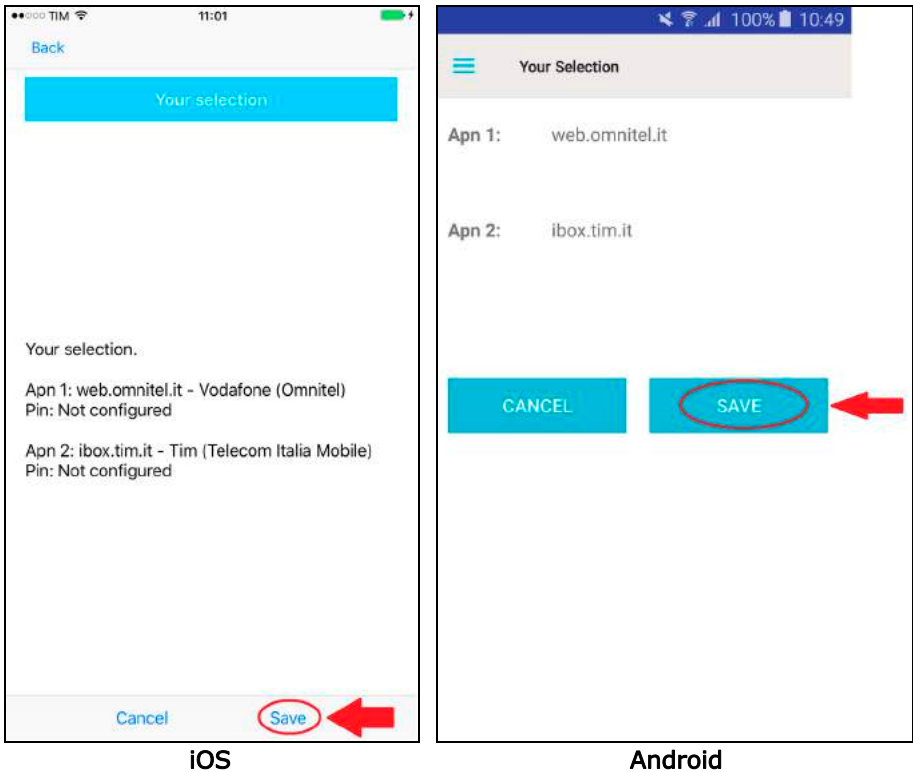

Fig. 22



5.4 CONTROL UNIT



iOS

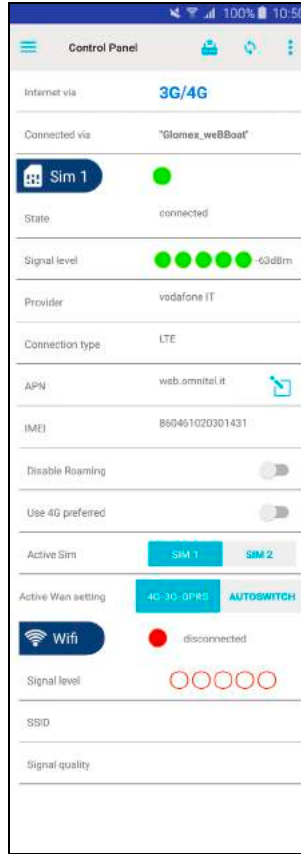

Android

Fig. 23

This screen display the system status which includes mobile connection, Wi-Fi connection, and the following information:

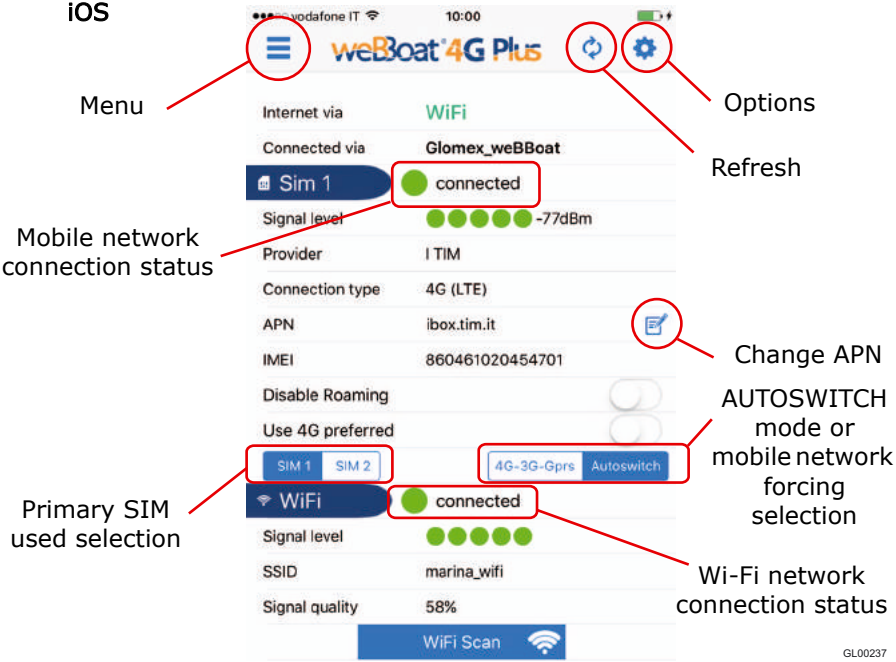

GL00237

Fig. 24

# weBBoat 4G Plus

Android

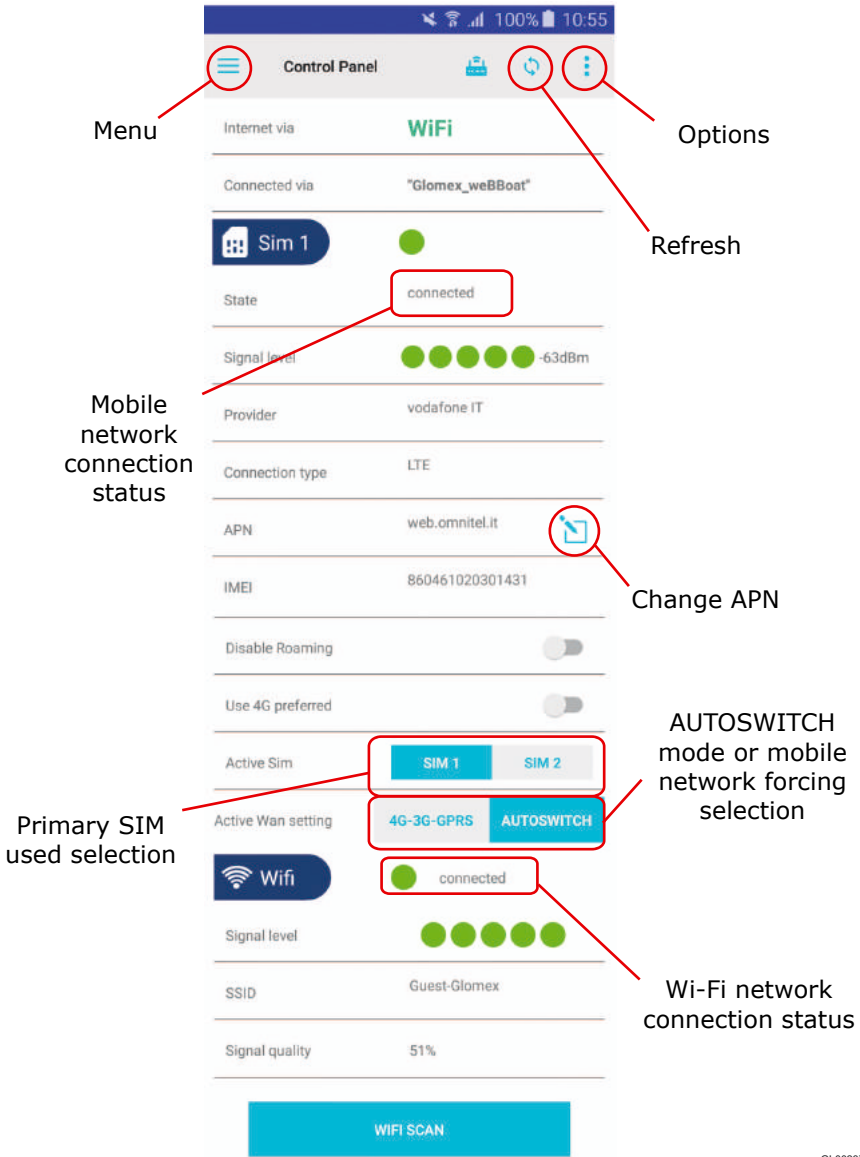

Fig. 24a

GL00237B

**Menu button** (see page 65 - Fig. 16)

- Configuration wizard: guided weBBoat 4G Plus configuration procedure
- Control Panel: where you access the weBBoat 4G Plus status screen
- User registration: user registration form
- Technical assistance: send an email to ask Glomex for technical assistance. To properly send the email to Glomex, weBBoat 4G Plus must be connected to a data network. (If it is not connected to a data network, you can in any case write the email that will be stored in the memory and will be sent as soon as there is a connection)
- Glomex www: link to the Glomex website
- Glomex shop: link to the Glomex online shop

**Refresh button:** to update the status screen.

**Options button:** see page 78.

**Internet via:** displays the type of data network being used (3G/4G or Wi-Fi will be displayed).

**Connected via:** displays the name of the network (SSID) you are connected to (e.g. Glomex\_weBBoat). You must be connected to the weBBoat 4G Plus Wi-Fi network in order to properly view the data and system configuration.

**XX dBm:** signal level in dBm.

**Mobile network connection status:** displays the weBBoat 4G Plus status of connection with your mobile carrier network.

**Signal level:** Signal level of the mobile network of the SIM being used (min. 1 / max. 5).

**Provider** Name of the telephone carrier connected.

**Connection type:** connection technology being used.

**APN:** APN being used.

**Change APN:** The APN has to be changed if the SIM is changed. See the SIM 1 CONFIGURATION section and the ALTERNATIVE APN CONFIGURATION section (page 67).

**IMEI:** telephone module serial number.

## weBBoat 4G Plus

**Disable roaming:** enables and disables roaming based on your needs.

**NOTE: Data roaming charges may be high so check the rate plan in use with your carrier.**

**Use 4G network only:** set 4G as the preferred connection; if only 2G/3G networks are in the area, the system will not connect to the data network.

**Primary SIM used selection:** To select the SIM to use for navigating the web through the mobile network.

**Autoswitch mode or mobile network forcing selection:** to select the autoswitch mode (automatic switching between mobile network and Wi-Fi network, if present and properly configured) or to force the mobile connection only. If autoswitch is selected, the Wi-Fi networks available will be scanned.

**Wi-Fi network connection status:** displays the status of the weBBoat 4G Plus connection with the external Wi-Fi network.

**Signal level:** Signal level of the external Wi-Fi network being used (min. 1 / max. 5).

**SSID:** name of the external Wi-Fi network being used.

**Signal quality:** displays the quality of the external Wi-Fi signal being used.

**Wi-Fi Scan:** scanning of the Wi-Fi networks available.

**NOTE: The Wi-Fi scan button appears only if Autoswitch mode has been selected. To scan, the autoswitch mode has to be selected.**

The Wi-Fi networks available will be displayed (Fig. 25).

A padlock if encrypted and the signal quality will be displayed for each Wi-Fi network.

Select the Wi-Fi network you want. If encrypted, the password will be requested. Enter it and press **OK** in the iOS version or **Save** in the Android version (Fig. 26).

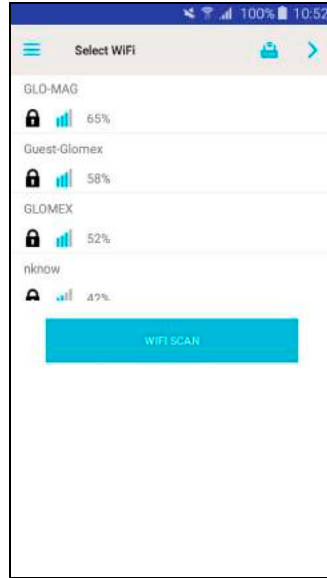

Fig. 25

iOS

Android

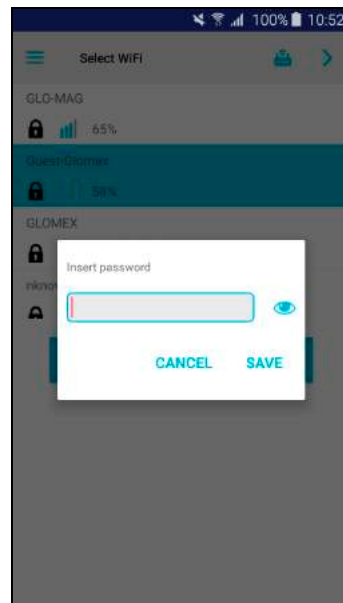
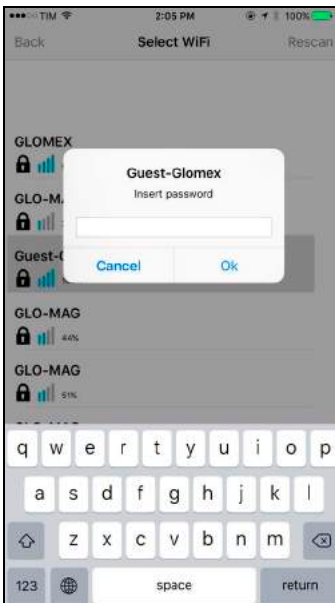

Fig. 26

iOS

Android

## weBBoat 4G Plus

At this point a screen summarizing the choices made will be displayed; now press **Save** in the iOS version or **SAVE** in the Android version (Fig. 27).

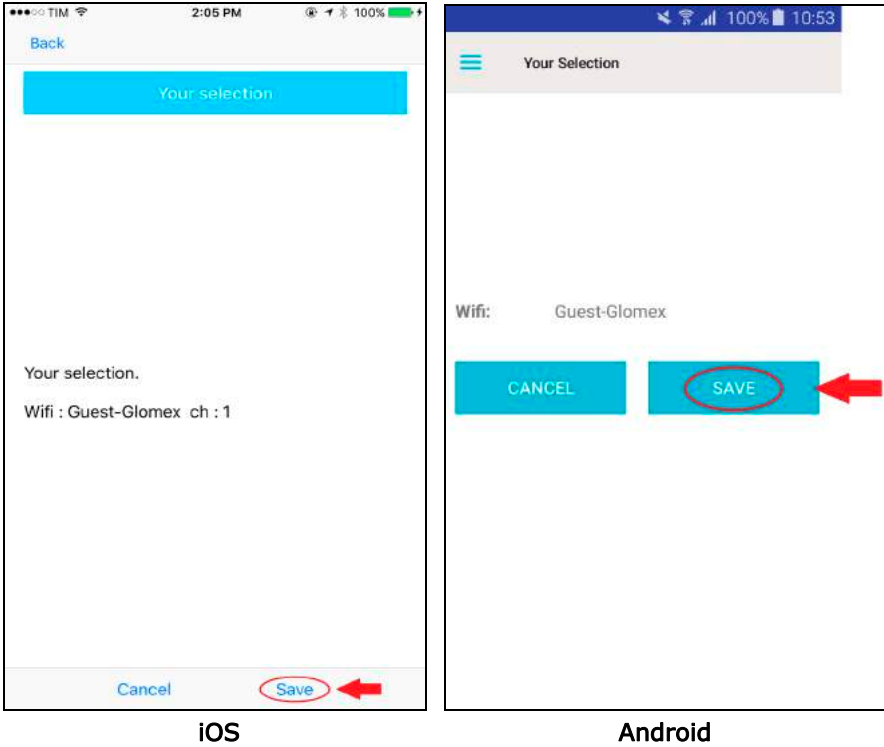
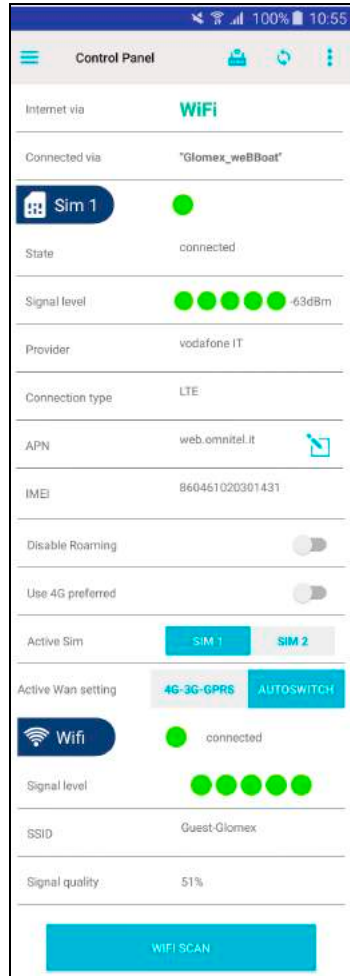

Fig. 27

The control panel with summarized information will then be displayed (Fig. 28).



iOS



Android

Fig. 28



## 6. OPTIONS BUTTON

The menu of Fig. 29 will be displayed when the options button is pressed.

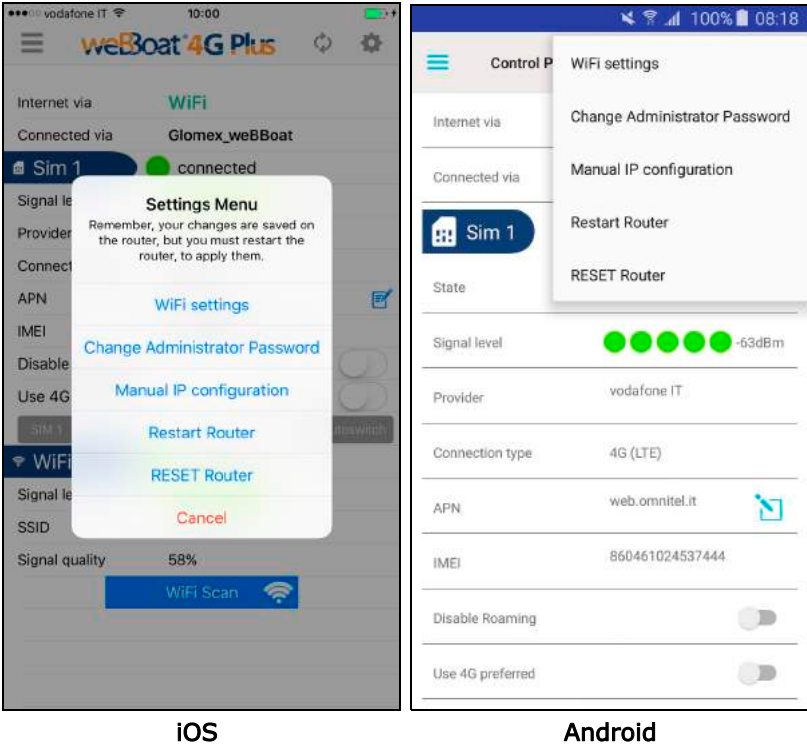
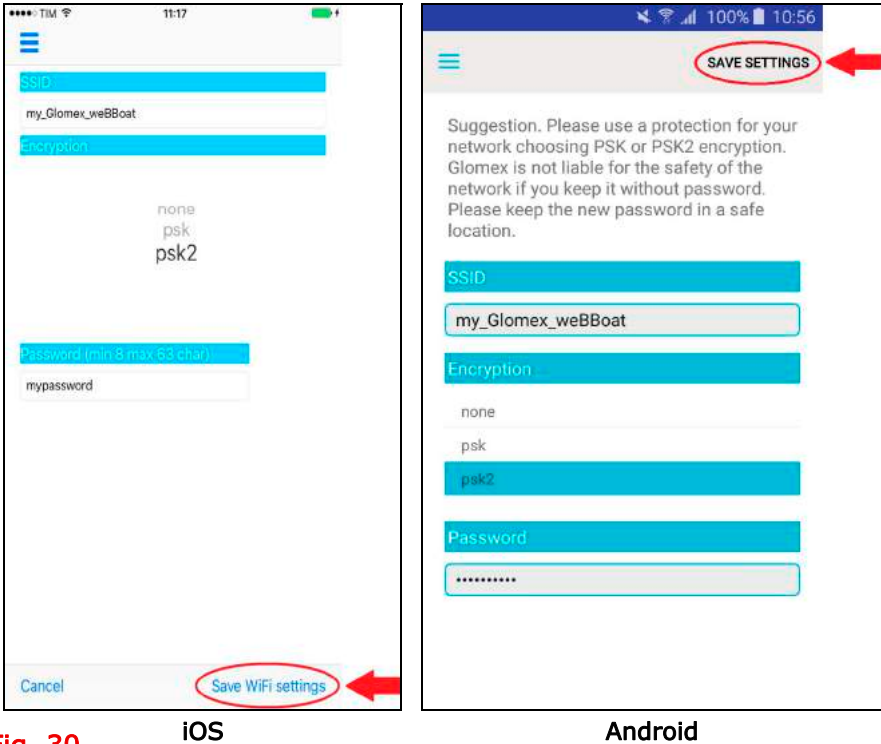

Fig. 29

## 6.1 Wi-Fi SETTING

If you select this option, you can personalize the name of the Wi-Fi network generated by weBBoat 4G Plus (SSID) and its password (we recommend setting code psk2) (Fig. 30).



**Fig. 30**

iOS

Android

**NOTE:** do not use spaces or special characters in the name of the Wi-Fi network and password.

Now press **Save Wi-Fi settings** in the iOS version or **SAVE SETTING** in the Android version to save the new settings. Press OK when prompted to restart the router.

## weBBoat 4G Plus

You will have to wait about one minute and reconnect your device to the new Wi-Fi network of weBBoat 4G Plus (Fig. 31 and Fig. 32).

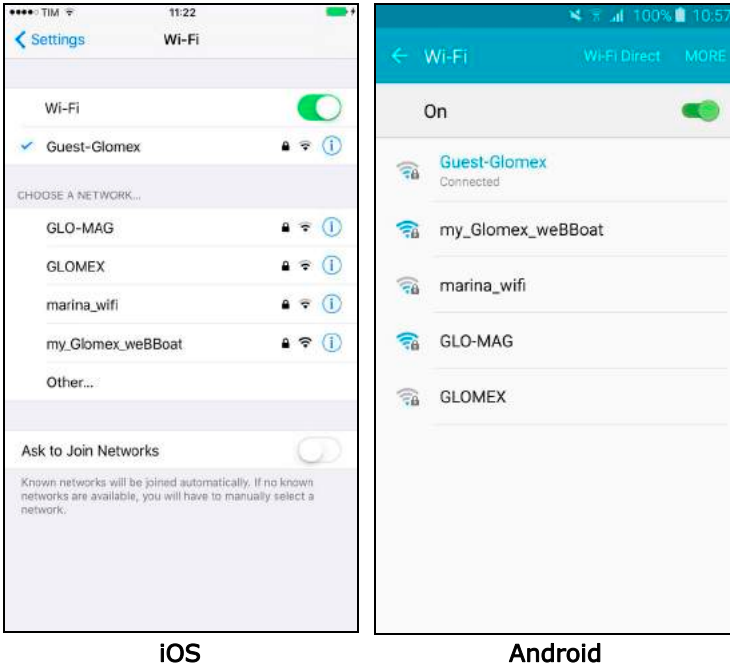
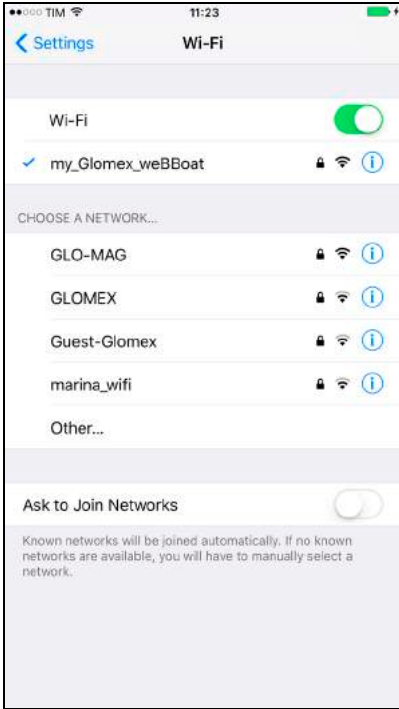
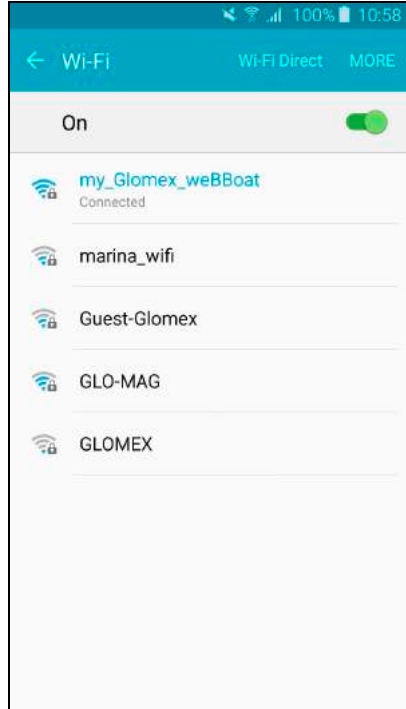

Fig. 31



IOS



Android

Fig. 32

## 6.2 CHANGE ADMINISTRATOR PASSWORD

**NOTE:** carefully read the warning and press OK.

By selecting this option, you can change the administrator password. Enter the new password in the two text fields and press save (Fig. 33).

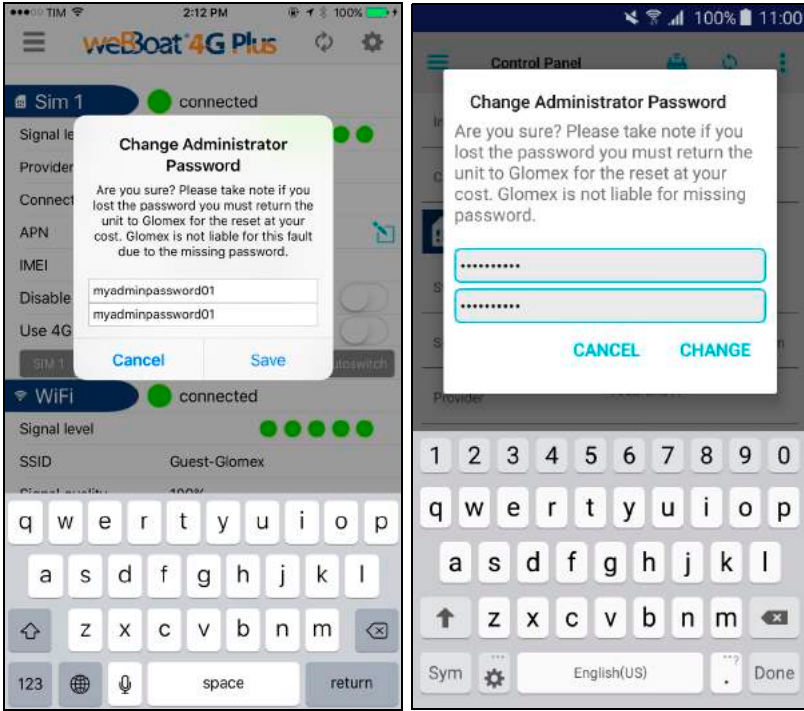

Fig. 33 iOS

Android

### ⚠ WARNING

---

If the administrator password should be lost, a factory reset of weBBoat 4G Plus will be necessary (see point 6.6).

---

### 6.3 MANUAL IP CONFIGURATOR

By selecting this option, you are able to change the IP address of the weBBoat 4G Plus if there are conflicts with other networks. The factory-set IP address is 192.168.80.1 (Fig. 34).

The options let you configure weBBoat 4G Plus as follows:

LAN 1 = 192.168.1.1

LAN 2 = 192.168.20.1

LAN 3 = 192.168.40.1

LAN 4 = 192.168.60.1

LAN 5 = 192.168.80.1 (not present because it is selected by default)

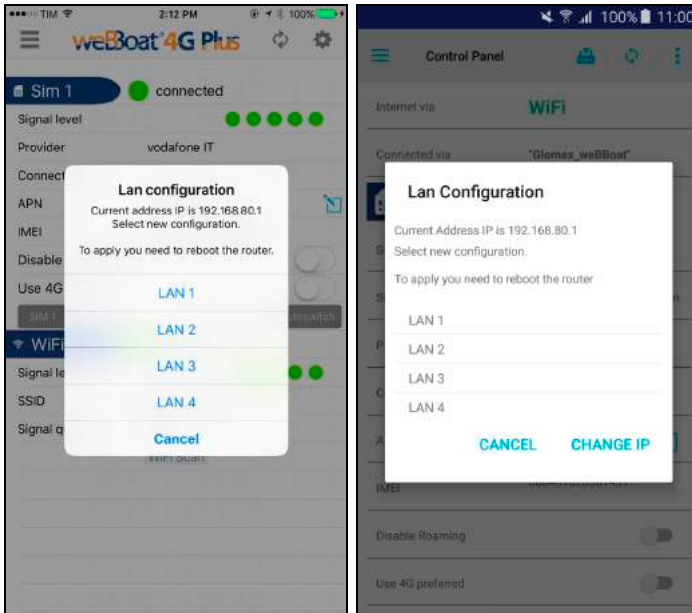

iOS

Android

**Fig. 34**

Select the configuration you want and press **OK** in the iOS version or **CHANGE IP** in the Android version to save the new settings. Now wait about one minute and reconnect the device to the Wi-Fi network of weBBoat 4G Plus.

## weBBoat 4G Plus

### 6.4 RESTART ROUTER

weBBoat 4G Plus will be restarted when this option is selected.

### 6.5 RESET ROUTER

The factory settings of weBBoat 4G Plus will be restored when this option is selected.

### 6.6 FACTORY RESET

To restore the factory system settings (FACTORY RESET) please follow this procedure:

- Start the device and wait 2 minutes.
- Open the top radome of weBBoat 4G.
- Press the reset button on the router (button 4 - Fig. 35) for at least 10 seconds.

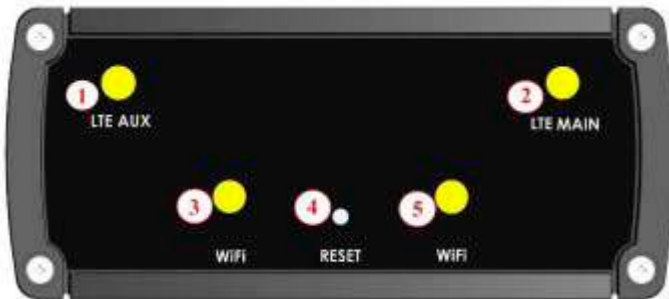

**Fig. 35**

#### Key

- 1 LTE auxiliary antenna connector
- 2 LTE main antenna connector
- 3,5 Wi-Fi antenna connectors
- 4 Reset button

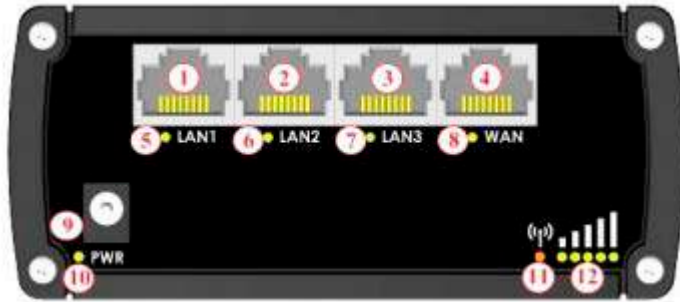

**Fig. 36**

### Key

1,2,3 LAN Ethernet ports

4 WAN Ethernet port

5,6,7 LAN LEDs

8 WAN LED

9 Power socket

10 Power LED

11 connection status LED (red= not connected / orange= 3G / green= 4G)

12 Signal strength indication LEDs

### NOTES

To help the user determine how long the reset button has to be pressed, the signal indicator (number 12 - Fig. 36) must be checked. Wait for all 5 LEDs to turn on. Now the reset button can be released.

The beginning of the reset procedure is confirmed when all 4 LEDs of the Ethernet ports (numbers 5, 6, 7 and 8 - Fig. 36) turn on at the same time. The procedure completes in about 1 minute and is confirmed when the Glomex\_weBBoat Wi-Fi network is created.



## 7. UPDATING FIRMWARE AND SETTINGS BACKUP

When a firmware update becomes available, a notification symbol will appear on the options button on the home page of the App (Fig. 37).

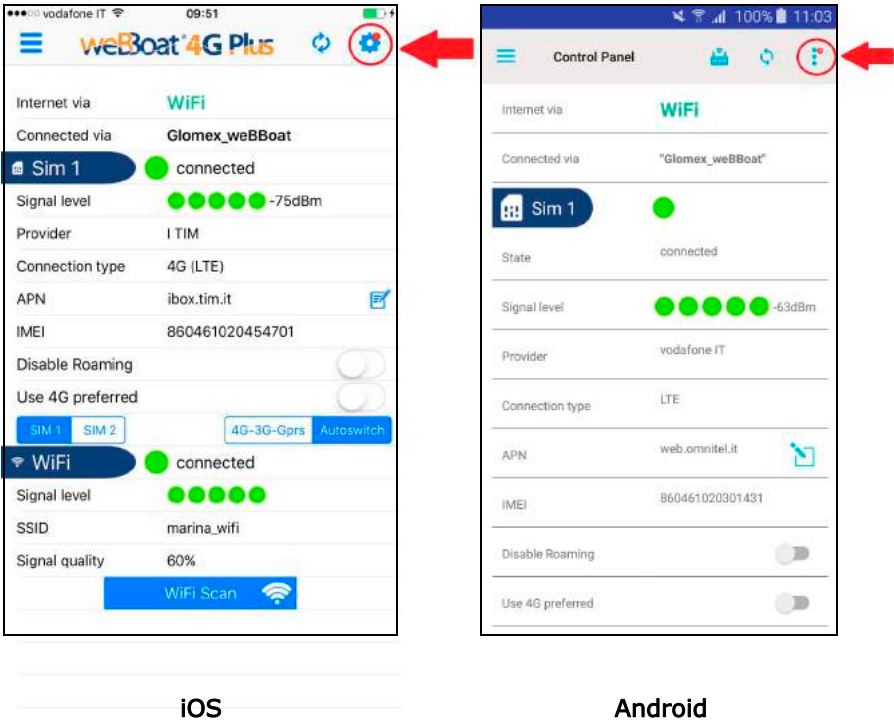

Fig. 37

Click the Options symbol and select Firmware upgrade (Fig. 38).



Fig. 38

iOS

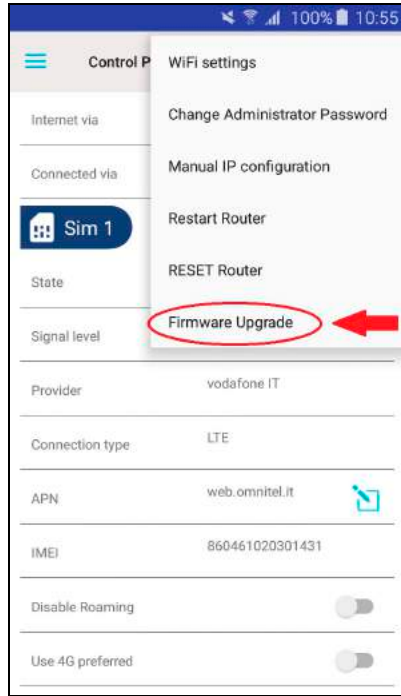

Android

## weBBoat 4G Plus

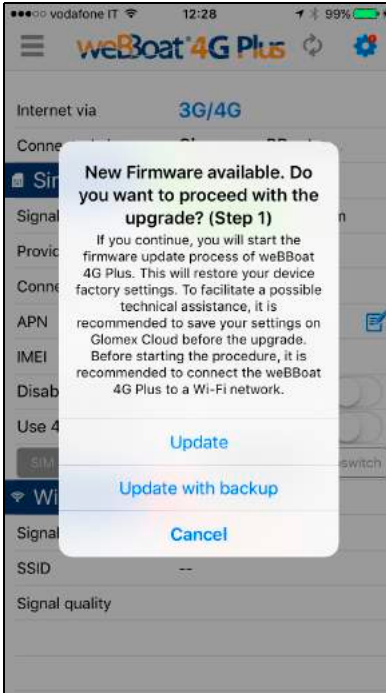
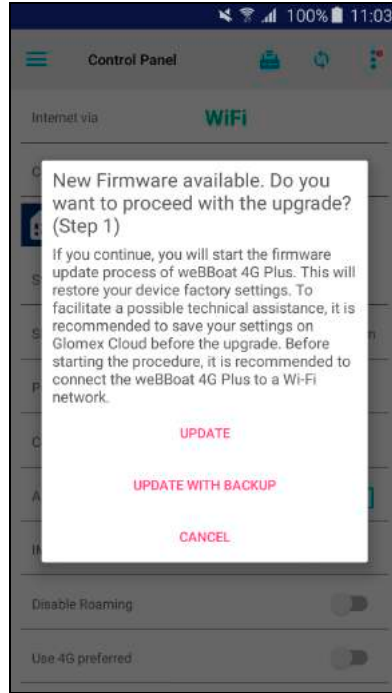

Fig. 39 iOS



Android

Now you will be asked to choose one of the following options (Fig. 39):

**Refresh button:** to update the Firmware without backup.

**Refresh with backup button:** before the Firmware is updated, the App backs up the settings and sends a summary via email.

**Cancel button:** cancels the Firmware update operation.

**NOTE:** If you update the firmware, the weBBoat 4G Plus will default to the original settings. It is recommended to Update with backup so the settings will be restored after completion of the update. Should you have any difficulties, you may also contact technical support.

**NOTE:** Before starting the update procedure, connect weBBoat 4G Plus to a Wi-Fi network.

When you press the Refresh with backup button (Fig. 39), you will have to enter an email address to which the weBBoat 4G Plus configuration summary will be sent before the Firmware is updated (Fig. 40).

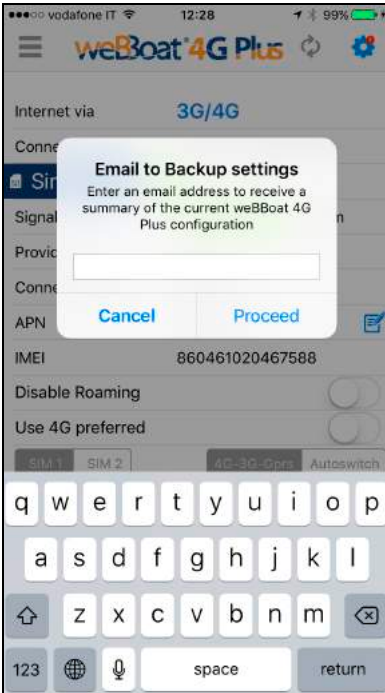
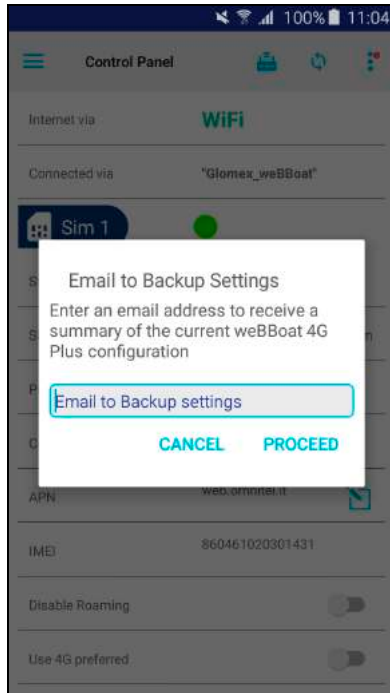
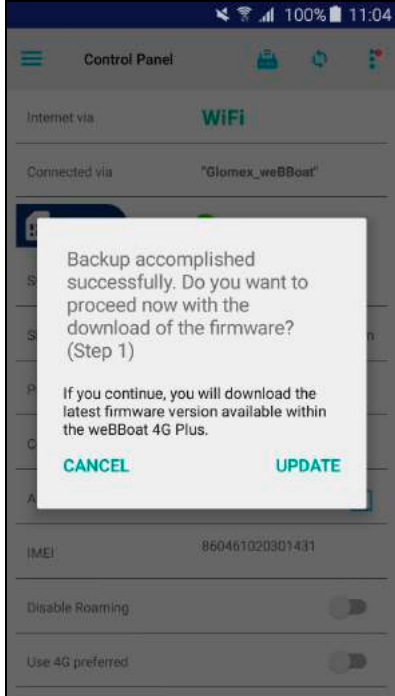
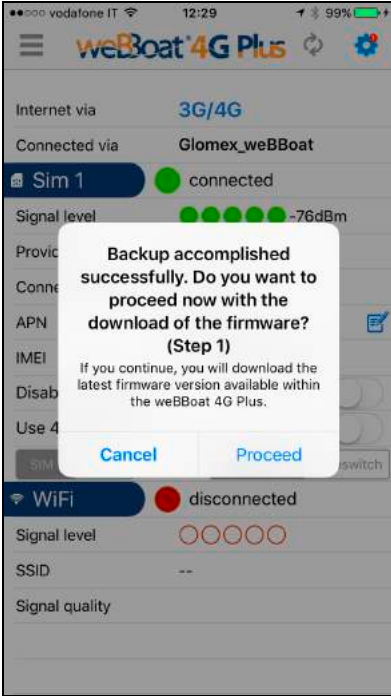

Fig. 40 iOS



Android

# weBBoat 4G Plus



**Fig. 41**

**iOS**

**Android**

Once the settings backup has completed, press Continue to download the latest Firmware release available to weBBoat 4G Plus (Fig. 41).

The device will ask you to continue with the update after the Firmware update has been downloaded (Fig. 42). The update is completed when the Wi-Fi Glomex\_weBBoat network appears.

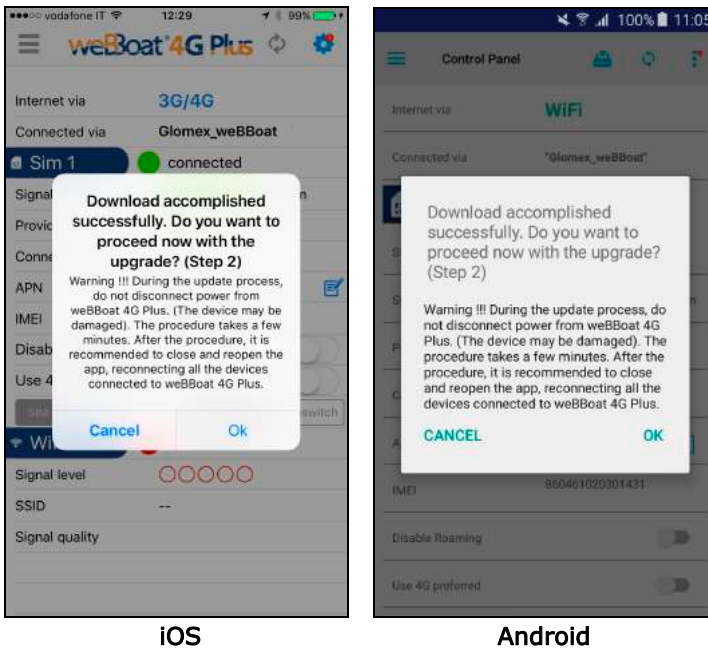

Fig. 42

### ⚠ WARNING

---

weBBoat 4G Plus must remain connected to the power supply during the Firmware update procedure in order to prevent irreparable damage to the device.

---