



THE SCIENCE OF SURVIVAL

AISLink™ CA2



AIS Class A Transceiver USER MANUAL



© 2020 ACR Electronics

The technical data, information and illustrations contained in this manual were believed to be correct at the time of print. ACR Electronics reserve the right to change specifications and other information contained in this manual as part of our continual improvement process.

No part of this manual may be reproduced, stored in a retrieval system or transmitted in any form, electronic or otherwise, without the prior permission of ACR Electronics.

No liability can be accepted for any inaccuracies or omissions in this manual.

ADDITIONAL INFORMATION

CA2 INSTALLATION MANUAL

Y1-03-0294

CA2 QUICK REFERENCE GUIDE

Y1-03-0295

CA2 INLAND WATERWAYS SUPPLEMENT

Y1-03-0363



1. SAFETY WARNING

- ! This equipment must be installed in accordance with the instructions provided in this manual. Failure to do so will seriously affect its performance and reliability. It is strongly recommended that a trained technician installs and configures this product.
- ! This equipment is intended as an aid to navigation and is not a replacement for proper navigational judgement. Information provided by the equipment must not be relied upon as accurate. User decisions based upon information provided by the equipment are done so entirely at the users own risk.
- ! Do not install this equipment in a flammable atmosphere such as in an engine room or near to fuel tanks.
- ! It is recommended that this product is not installed in direct sunlight or under a windshield where it can be subjected to excessive solar heating
- ! Do not attempt to service this equipment as doing so may cause fire, electric shock or malfunction and will invalidate the warranty. If any malfunctions are detected contact your supplier or service agent.
- ! Do not install the transceiver where rain or water may leak onto the equipment. This product has been designed for installation and use in an environment protected from moisture.
- ! NOT ALL SHIPS CARRY AIS. The Officer of the Watch (OOW) should always be aware that other ships and, in particular, leisure craft, fishing vessels and warships may not be fitted with AIS. Any AIS equipment fitted on other ships as a mandatory carriage requirement may also be off based on the Master's professional judgement

2. GENERAL NOTICES

- ! All marine Automatic Identification System (AIS) transceivers utilise a satellite based location system such as the GLONASS or GPS satellite networks.
- ! The compass safe distance of this transceiver is 0.5m or greater for a 0.3° deviation.
- ! This product is categorised as 'protected' in accordance with the definitions provided in IEC 60945.
- ! Please dispose of this AIS transceiver in accordance with the European WEEE Directive or with the applicable local regulations for disposal of electrical equipment.
- ! This manual is intended as a guide to the installation, setup and use of this product. Every effort has been made to ensure the accuracy of this manual, however due to continuous product development this manual may not be accurate in all respects, therefore no guarantee is offered. If you are in any doubt about any aspect of this product, please contact your dealer.



1.	Safety Warning	3
2.	General notices	3
3.	Basic OPERATION	6
3.1	Front Panel Controls	6
3.2	Front Panel Controls Explained	6
3.3	User Interface Overview	8
3.4	Menu Structure	9
4.	STATUS ICONS	10
4.1	Position Fix	10
4.2	Chart Orientation	10
4.3	Navigation Status	10
4.4	CPA Alarm	10
4.5	Message	10
4.6	Information & Caution	10
4.7	Warnings	10
4.8	Transmitter Mode	10
5.	BUTTON CONTROLS	11
5.1	Menu	11
5.2	Brightness	11
5.3	Voyage Data	11
5.3.1	Quick Status	12
5.3.2	ETA	12
5.3.3	TCPA/CPA Alarm	12
5.4	Page Select	13
5.4.1	Map Screen - see page 14	13
5.4.2	Target List Screen - see page 18	13
5.5	Target Radar Screen - see page 19	14
6.	SCREEN DETAILS	14
6.1	Map Screen	14
6.1.1	Map Options	16
6.1.2	Chart Screen Scale and Position	17
6.2	Target List Screen	18
6.3	Target Radar Screen	19
6.4	Target Information Screen	20
6.4.1	Aid to Navigation Types	22
6.4.2	Target Cargo	22
6.4.3	Navigation Status	23
6.4.4	Position Quality Description	23







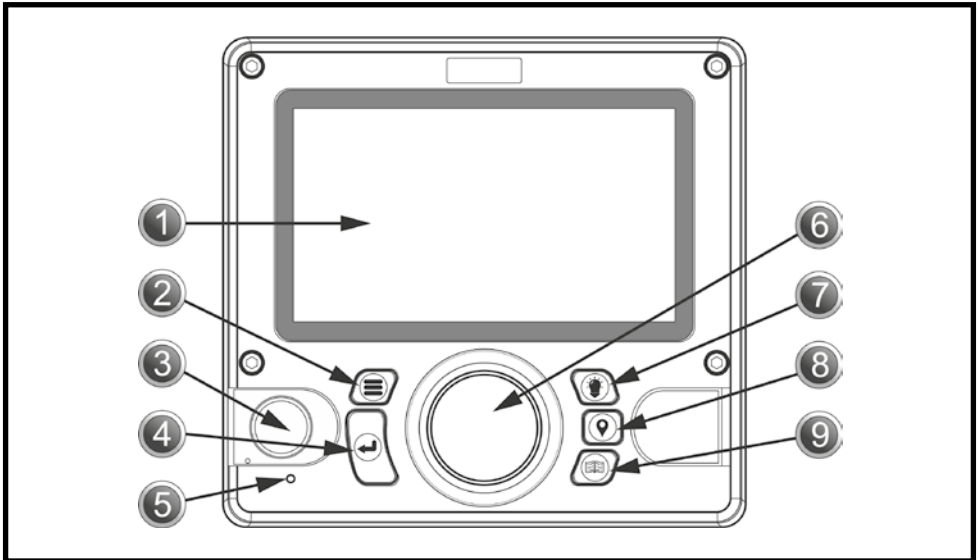

7.	Messages	24
7.1	Message Pop-up Screen	24
7.1.1	Send Message	25
7.1.2	Text Messages List	27
7.1.3	Safety Messages List	28
7.1.4	System Alerts	28
7.1.5	Status Messages	30
8.	STATUS	31
8.1	System	31
8.1.1	Status	31
8.1.2	Info	32
8.1.3	Log	32
8.2	Ownship Static	33
8.3	Ownship Dynamic	34
8.4	GNSS Status	34
8.4.1	Internal GNSS	34
8.4.2	External GNSS	35
9.	Settings	35
9.1	Password Protection	35
9.2	AIS	36
9.2.1	Voyage	36
9.2.2	Ownship	37
9.2.3	Friends	38
9.2.4	Regions	40
9.3	System	41
9.3.1	General	41
9.3.2	Audio Alerts	42
9.3.3	WiFi	42
10.	Glossary and abbreviations	44
11.	Maintenance	44
11.1	Product Cleaning	44
11.2	Service and Maintenance	45
11.3	Firmware Updates	45
11.3.1	To update Firmware	45
11.4	Routine equipment checks	46
12.	Approvals	46
12.1	EU Marine Equipment Directive	46
12.2	United States of America	46
12.3	Canada	46
13.	Specifications	47
14.	Spares and Accessories	47

3. BASIC OPERATION

3.1 Front Panel Controls



No.	Item	No.	Item
1	LCD Screen	6	 Jog Stick/Control Knob
2	 Menu Key	7	 Display Brightness Key
3	Pilot Plug (under cover)	8	 Voyage Data Input Key
4	 Enter Key	9	 Page Key
5	Indicator LED		

3.2 Front Panel Controls Explained

1. LCD Panel Display

The CA2 incorporates a 7-inch full-colour LCD Display allowing for visibly pleasing maps and screens, ensuring a user-friendly experience and ease-of-use.

2. Menu Key

Pressing the menu key will access the CA2 menu system. The menu screen that appears will depend on the screen in use when the menu key is pressed. The menu key can also be used to close the menu system.

3. Pilot Plug

The pilot plug allows pilots and other mariners to connect a laptop PC or other portable device directly into the CA2 giving access to the AIS information of the vessel including necessary dynamic and static vessel information.

4. Enter Key

The enter key on the CA2 allows the user to select a hi-lighted field and either see information or enter information as necessary. This entering process can also be achieved by depressing the jog stick on the front panel.

5. Indicator LED

Green - Power on

Amber flash - Each Transmit

Amber - Silent Mode

Red - Transmit fail

6. Jog Stick

The jog stick allows the user to navigate through the different screens and menus of the CA2 using directionality of up, down, left and right and also by rotating clockwise and counter clockwise. The jog stick can also be depressed as an alternative to using the enter key.

7. Display Brightness Key

Pressing the display brightness key on the front panel will access a brightness level indicator. Rotate the jog stick to increase or decrease the light level.

8. Voyage Data Input Key

Pressing the voyage data input key allows quick access to update variable voyage information such as navigational status and estimated time of arrival.

9. Page Key

Pressing the Page key will allow the user to alternate between three target view screens. These are Map Screen, Target List Screen and Target Radar Screen. Pressing the page key will close all open menus and windows (except for Alarm pop-up windows) and revert back to the last active target view screen.



3.3 User Interface Overview

- ! When the CA2 is powered on for the first time, a map warning will be displayed. To remove this window it must be accepted to confirm that it has been read and understood. This window will appear once every 24 hours and will need to be accepted to remove it.



Press  to accept





3.4 Menu Structure



Pressing the  (Menu) key activates the on-screen menu.

Options with > show access to a further menu level.

Options with ... show access to a set-up screen.

Rotate the  (Jog Stick) to highlight your selection and then press  (Enter) to show the next menu level.

When a selection has no > or ... then pressing  (Enter) will select that option.

Pressing the  (Jog Stick) is an alternative to pressing  (Enter).

For example:

  **Status**   **GNSS Status**  will show the menu below

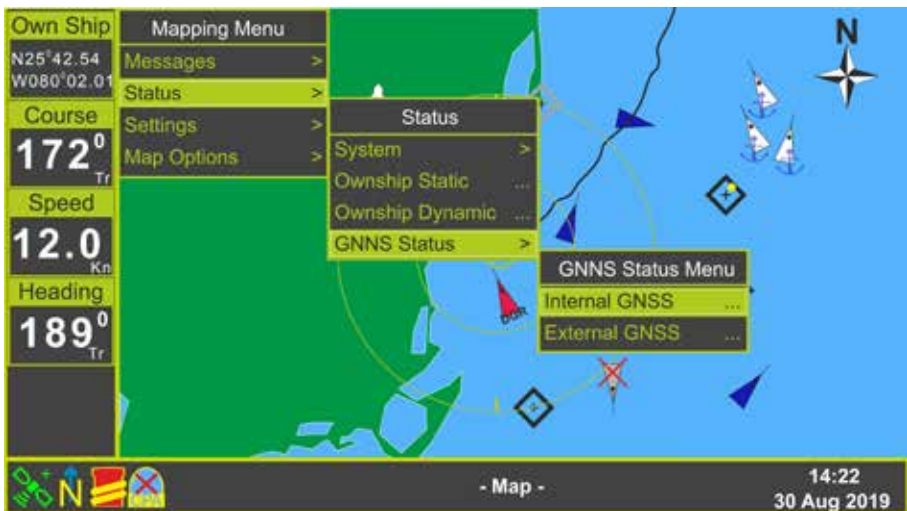

Pressing  will then select the Internal GNSS Status page.

4. STATUS ICONS

A row of icons along the bottom information bar underneath the active page give basic information regarding the status of the AIS Transceiver.

4.1 Position Fix

	Blue	- Indicates an internal GNSS receiver fix	+ - Differential (DGPS)
	Green	- Indicates an external GNSS receiver fix	! - Temporary loss of signal
	Red	- Indicates no GNSS fix available	

4.2 Chart Orientation



Indicates the orientation of the chart screen:
North Up, Heading Up or Course Up

4.3 Navigation Status



Indicates the basic navigation status:
At Anchor, Under Way or Moored

4.4 CPA Alarm



Green - Indicates Closest Point of Approach alarm enabled
Red (flash) - Indicates Closest Point of Approach alarm active
With a red cross - Indicates Closest Point of Approach alarm disabled

4.5 Message



Indicates there are unread messages in one of the In-boxes
Flashing indicates there are multiple messages

4.6 Information & Caution



Indicates there are active Caution messages

4.7 Warnings



Indicates there are System Warnings active:
Unacknowledged, Acknowledged, Rectified unacknowledged

4.8 Transmitter Mode





Indicates the System is operating at Low Power Mode or Silent Mode.
See section 9.3.1 of this manual for further information.

5. BUTTON CONTROLS

5.1 Menu



Pressing the menu button will bring up the first level of the settings menu.



Rotate  to select the required option then press  to move to the next menu level. Pressing  again will move back through the menu levels.

5.2 Brightness

Pressing the brightness button on any screen will bring up the screen brightness slider.

Rotate  to increase or decrease the brightness.

If the screen looks black at any time try pressing  and rotating  to make sure the brightness has not been turned right down.

Press  or  to remove the brightness bar.

5.3 Voyage Data

Pressing the Voyage Data button brings up the Quick Status pop-up page.

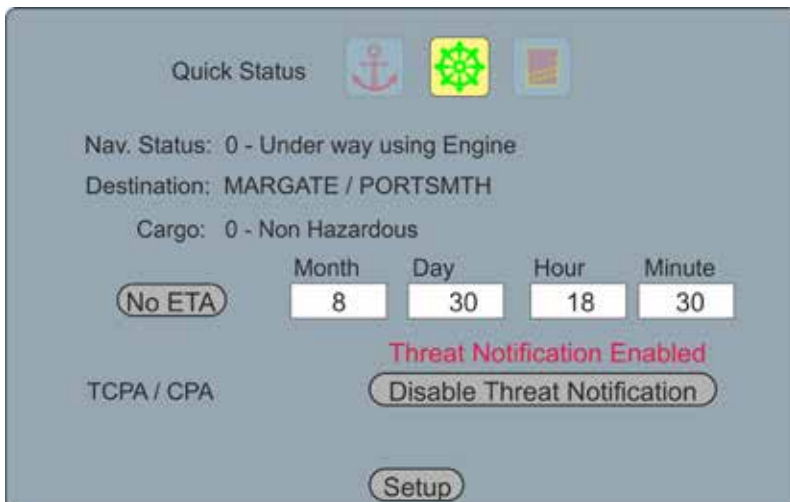



5.3.1 Quick Status

To quickly change your Navigation Status use  to select one of the three icons at the top of the screen:



At Anchor



Under way - selection enters the default status (See 9.2.1)



Moored

Your default destination is displayed, should you wish to change this or enter an alternative Navigation Status then select and click "Setup" to enter the full Navigation Status page.

5.3.2 ETA

Select and click the "ETA" button to expand the entry selection

Destination: MARGATE / PORTSMTH

	Month	Day	Hour	Minute
No ETA	8	31	08	30

Pressing  in any data box will bring up the keyboard. If you do not wish to set an ETA then select and click "No ETA" to clear the fields.

5.3.3 TCPA/CPA Alarm

Select the TCPA/CPA "Threat Notification" button and use  to toggle Notification Enabled / Disabled.

The Alarm will sound as directed by the TCPA and CPA settings set in the full Navigation Status page. Select and click "Setup" to change these settings as described in section 9.2.1 on page 36 of this manual.

If you see "TCPA/CPA Feature Disabled" the CPA and TCPA values have been set to 0 (zero). Select and click Setup to change the values. Once distance and time have been entered the Threat Notification pop-up will be enabled, dangerous targets will appear red on the chart and radar screens and an audible alert will sound as a target activates.

Disable the Threat notification to prevent pop-up and audible alert. Dangerous targets will still appear red on the chart and radar screens.

The audio notification can be disabled in Settings>System>Audio Settings.



5.4 Page Select

Pressing page select moves through the three main display screens available:

5.4.1 Map Screen - see page 14



5.4.2 Target List Screen - see page 18

Own Ship	MMSI Number	Name	RNG	BRG	CPA	Age
N25°42.54 W080°02.01	XXXXXXXXXX	BELIEVER	1.2	178°	0.1	2s
Course	XXXXXXXXXX	MATTHEW	3.0	078°	3	32s
172° _{Tr}	XXXXXXXXXX	FEAR	4.3	075°	4	0s
Speed	XXXXXXXXXX	TOGETHER	6.0	175°	4	1M
12.0 _{Kn}	XXXXXXXXXX	GREEN GRASS	6.1	103°	3	2M
Heading	XXXXXXXXXX	HEY JOE	6.2	185°	6	1s
189° _{Tr}	XXXXXXXXXX	BAD BOY	7.2	045°	7	5s
	XXXXXXXXXX	SHADOW	8.2	345°	8	13s
	XXXXXXXXXX	HAPPY JACK	9.1	035°	9	4s
	XXXXXXXXXX	MORNINGTOWN	9.2	189°	9	36s
	XXXXXXXXXX	[UNKNOWN]	9.3	095°	9	1M
	XXXXXXXXXX	FREE	11.8	135°	12	24s
	XXXXXXXXXX	THE PARK	12.6	034°	13	8s
	XXXXXXXXXX	SUGAR TOWN	13.2	029°	13	27s

Active Targets Sorted By: Distance

Bottom Bar:

- Left: Navigation icons
- Center: "- Target List -"
- Right: Time "14:22" and Date "30 Aug 2019"



5.5 Target Radar Screen - see page 19





















6. SCREEN DETAILS

6.1 Map Screen



The Map Screen shows visible targets on basic cartography.

Item	Description	Information
	Own Ship	Can be turned on and off in settings
	Pointer	The pointer is not visible until the jog wheel is active.  to point to a target
  	White - Class A Vessel	The orientation of the line from the front of the target indicates the True Heading of the target vessel. If the vessel is not transmitting a heading then the triangle will be orientated to COG and the orientation line will not be present. Stationary vessels with no heading transmitted will point to the top of the screen.
	Magenta - Class A Friend Vessel	
	Light Blue - Class B Vessel	
	Dark Blue - Class B Friend Vessel	
	Red (flash) - Dangerous Target	This target definition is defined by the CPA and TCPA settings
	White - Class A Vessel at anchor	
	Indicates a lost target	This target definition indicated that a previously received target has not been received as subsequently expected.
	Shows a target has been selected	Press  to display further information
	Land Based Stations	
	SART	
	MOB Devices	
	AtoN	
	Virtual AtoN	
	AtoN Off Position	
	Search and Rescue Craft	
	Chart North Indicator	Shown opposite in North Up mode this icon rotates when the map is set to Course Up or Heading Up mode



6.1.1 Map Options

Press **Map Options** when the Map Screen is being displayed shows



Use and to select:

Orientation

North Up	Course Up	Heading Up

Range Rings

Enabled	Disabled

Grid

Enabled	Disabled

Owship Trail

Enabled	Disabled
 A map showing a coastline on the left and a body of water on the right. A blue trail, representing the Owship Trail, is visible in the water, extending from the vessel's position (marked with a small icon) towards the land.	 A map showing the same coastline and body of water as the 'Enabled' view. However, the blue trail is not present, indicating that the Owship Trail feature is disabled.

6.1.2 Chart Screen Scale and Position

The scale of the chart can be changed by rotating the  (Jog Stick) where an indication of the scale is given on the range rings.

To scroll the map away from being centred on the vessel's position push the  (Jog Stick) move the cursor in the direction you wish to scroll.

NOTE: The chart will return to centred position after 15 seconds of no cursor movement or on returning to the Chart Screen following viewing of another screen.



6.2 Target List Screen

Own Ship	MMSI Number	Name	RNG	BRG	CPA	Age
N25°42.54 W080°02.01	XXXXXXXXXX	BELIEVER	1.2	178°	0.1	2s
Course 172° Tr	XXXXXXXXXX	MATTHEW	3.0	078°	3	32s
Speed 12.0 Kn	XXXXXXXXXX	FEAR	4.3	075°	4	0s
Heading 189° Tr	XXXXXXXXXX	TOGETHER	6.0	175°	4	1M
	XXXXXXXXXX	GREEN GRASS	6.1	103°	3	2M
	XXXXXXXXXX	HEY JOE	6.2	185°	6	1s
	XXXXXXXXXX	BAD BOY	7.2	045°	7	5s
	XXXXXXXXXX	SHADOW	8.2	345°	8	13s
	XXXXXXXXXX	HAPPY JACK	9.1	035°	9	4s
	XXXXXXXXXX	MORNINGTOWN	9.2	189°	9	36s
	XXXXXXXXXX	[UNKNOWN]	9.3	095°	9	1M
	XXXXXXXXXX	FREE	11.8	135°	12	24s
	XXXXXXXXXX	THE PARK	12.6	034°	13	8s
	XXXXXXXXXX	SUGAR TOWN	13.2	029°	13	27s

Active Targets Sorted By: Distance

- Target List - 14:22
30 Aug 2019

Use and to select the required target and display the Target Information Screen. For further details see page 20 of this manual.

Pressing **Sort** when the Target List Screen is being displayed shows



Use and to select the required option.

6.3 Target Radar Screen



Pressing **Map Options** when the Map Screen is being displayed shows



Use and to select the required orientation

Use to move the cursor around the screen to display different target information

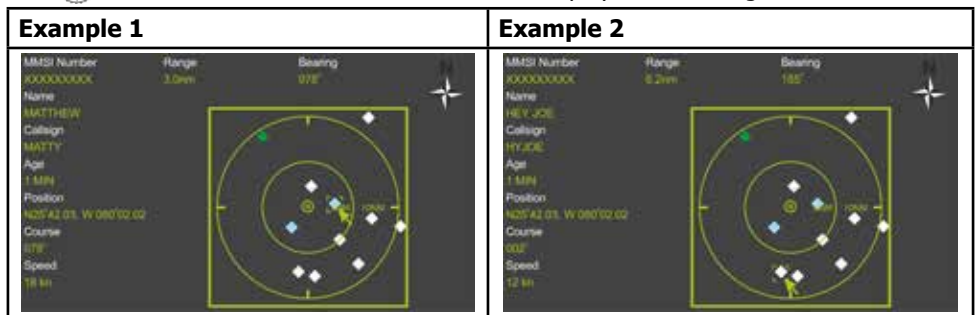



6.4 Target Information Screen

MMSI Number XXXXXXXX		IMO Number 000000000		Callsign XXXXXX		Class A	
Name SUGAR TOWN				Nav. Status 0 - Under way using Engine			
Latitude N26°02.06		Longitude W079°01.34		Vessel Type Cargo Ship - Type 70			
CPA 4.20 NM	TCPA >30 Mins +	Age 02:13		Cargo 0 - Unspecified			
Range 13.2 NM	Bearing 029°	Course 330° Tr		Length of Vessel 93 Metres		Beam of Vessel 19 Metres	
Speed 10.0 kn	ROT 0° /min R	Heading 325° Tr		Interrogate		Next Done	
Position Quality Description Position <= 10 m				PA High		RAIM No	
						Timestamp 31	

Target Information can vary depending on the AIS Class of the Transmitting device:

Title	Information		Class
Age	Time since the last message was received	Min:Sec	All
Altitude	The received target altitude	Metres	SAR
AtoN Type	Description and information for Aids to Navigation targets	See 1 over	AtoN
Beam of Vessel	Received target external beam	Metres	A, B
Bearing	Target bearing from you	Degrees	All
Callsign	VHF radio call sign	Text	A, B, SAR
Cargo	Received target cargo	See 2 over	A
Class	The type of AIS unit transmitting this information and the target status (see page 15)	A, B, SAR, AtoN, Base Station	All
Course	Received target Course Over the Ground	Degrees	A, B, SAR
CPA	Closest Point of Approach	NM	All
Destination	Received target destination	Text	A
DTE	Data Terminal Enabled	Yes/No	A
ETA	Received target ETA at Destination	Date & Time	A
Heading	Received target Heading (if available)	Degrees	A, B, SAR



IMO Number	Received target IMO number	Number	A
Interrogate	Click this to request updated information	Button	All
Latitude / Longitude	Received target position	Number	All
Length of Vessel	Received target overall length	Metres	A
Max Draught	Received target maximum draught	Metres	A
MMSI Number	Received target MMSI number	Number	All
Name	Received target name	Text	All
Nav. Status	Received target navigation status	See 3 over	A
Off Position	AtoN Information	Yes/No	AtoN
PA	Received target Position Accuracy	(<=10m, >10m)	All
Position Quality Description	Derived quality of target position	See 4 over	All
RAIM	Position Autonomous Integrity Monitoring	Yes/ No	All
Range	Target distance from you	NM	All
ROT	Received target Rate of Turn	Degrees/min	A
Speed	Received target Speed	Knots	All
TCPA	Time to Closest Point of Arrival	Min:Sec	All
Timestamp	Note of message transmitted time	Seconds	All
Vessel Type	The received target Type and Cargo	See 5 below	A
Virtual AtoN	AtoN	Yes/No	AtoN



6.4.1 Aid to Navigation Types

Type	Code	Definition	Type	Code	Definition
	0	Default, Type not specified		16	Beacon, Preferred Channel starboard hand
	1	Reference point		17	Beacon, Isolated danger
	2	RACON		18	Beacon, Safe water
	3	Fixed structures off-shore		19	Beacon, Special mark
Fixed	4	Reserved for future use		20	Cardinal Mark N
	5	Light, without sectors		21	Beacon, Cardinal E
	6	Light, with sectors		22	Beacon, Cardinal S
	7	Leading Light Front	Floating	23	Beacon, Cardinal W
	8	Leading Light Rear		24	Port hand Mark
	9	Beacon, Cardinal N		25	Starboard hand Mark
	10	Beacon, Cardinal E		26	Preferred Channel Port hand
	11	Beacon, Cardinal S		27	Preferred Channel Starboard hand
	12	Beacon, Cardinal W		28	Isolated danger
	13	Beacon, Port hand		29	Safe Water
	14	Beacon, Starboard hand		30	Special Mark
	15	Beacon, Preferred Channel port hand		31	Light Vessel/LANBY/Rigs

6.4.2 Target Cargo

Code	Description
0	Non Hazardous
1	DG, HS or MP - Category X
2	DG, HS or MP - Category Y
3	DG, HS or MP - Category Z
4	DG, HS or MP - Category OS



6.4.3 Navigation Status

Code	Description	Code	Description
20	WIG	52	Tug
30	Fishing	53	Port Tender
31	Towing	54	Anti Pollution
32	Towing >200m	55	Law Enforcement
33	Engaged in Dredging	56	Local Assignment
34	Engaged in Diving	57	Local Assignment
35	Engaged in Military	58	Medical Transport
36	Sailing	59	Non Armed Conflict
37	Pleasure Craft	60	Passenger Ship
40	HSC	70	Cargo Ship
50	Pilot	80	Tanker
51	Search and Rescue	90	Other Ship

6.4.4 Position Quality Description

Description	Criteria
No position	Latitude = 91° or longitude = 181° or time stamp = 63
Manual position	Time stamp = 61
Dead reckoning position	Time stamp = 62
Outdated position > 200 m	Predicted distance (from SOG and time elapsed) > 200 m
Position > 10 m	PA = 0 and RAIM = 0
Position with RAIM > 10 m	PA = 0 and RAIM = 1
Position < 10 m	PA = 1 and RAIM = 0
Position with RAIM < 10 m	PA = 1 and RAIM = 1
Valid position with no time stamp	Time stamp = 60

7. MESSAGES

7.1 Message Pop-up Screen

New messages and Alerts will be announced by a pop-up screen and an audible double beep:

Warning



Pressing Ignore will remove the pop-up but leave the Alert active.

Pressing OK will remove the pop-up and acknowledge the Alert.

For the definitions of Warnings and Alerts see section 7.1.4 on page 26 of this manual.



Message



Press OK to remove the pop-up. The messages can be viewed in the appropriate message lists (see page 25 of this manual).

Map Warning



The Map Warning pop-up appears on power up and every 24 hours of continual use. Press  or  to clear.



Long Range Request



up

Press Yes to send the full message request or No to send just the highlighted information. After 1.5 minutes the highlighted information only will be sent automatically and the pop-up will be cleared.

7.1.1 Send Message - Messages Send Message



Select the message Type and :
Broadcast Safety, Addressed Safety, Broadcast Text, Addressed Text.

Select a specific channel to send the message on if required. Leave as the default "Auto" if there are no specific requirements.

When selecting an Addressed message a pop-up will be displayed



Either enter a known MMSI number or use and to highlight the chooser.

Use and to select the required vessel.



displays the keyboard pop-up to enter the required message content.

There is a "Remaining Characters" number to help compile the message and once "Done" is selected from the keyboard there is a check-box to select whether a receipt acknowledgement is required.

For Addressed Text messages only there is an Acknowledgement Required check-box.

When everything is correct select "Send" and press .



7.1.2 Text Messages List - Messages Text Messages

Addressed Inbox - Broadcast Inbox - Addressed Outbox - Broadcast Outbox :

Date	Sender	Message
30/08/19 14:21:59	XXXXXXXXXX	TEST MESSAGE
27/08/19 14:00:04	XXXXXXXXXX	TEST MESSAGE 2
27/08/19 14:40:06	XXXXXXXXXX	ANOTHER TEST MESSA...
15/08/19 10:19:56	XXXXXXXXXX	A MUCH LONGER TEXT ...
10/08/19 04:31:12	XXXXXXXXXX	RFM55 - POB

Select any message in the list and press to see more information.

Additional content is added to the Messages Menu : Delete Selected / Delete All and Sort where sort selection options are: By Date or By Sender.



7.1.3 Safety Messages List - Messages Safety Messages Addressed Inbox - Broadcast Inbox - Addressed Outbox - Broadcast Outbox

Date	Sender	Message
30/08/19 14:21:59	XXXXXXXXXX	TEST MESSAGE
27/08/19 14:00:04	XXXXXXXXXX	TEST MESSAGE 2
27/08/19 14:40:06	XXXXXXXXXX	ANOTHER TEST MESSA...
15/08/19 10:19:56	XXXXXXXXXX	A MUCH LONGER TEXT ...

Additional content is added to the Messages Menu : Delete Selected / Delete All and Sort where sort selection options are: By date or By Sender

7.1.4 System Alerts - Messages System Messages Alerts:

Activation Time	Alert	Description	ACT	ACK	PRI
30/08/19 12:44:09	3119:4	Missing ROT	No	No	C
30/08/19 11:53:25	3119:3	Missing Heading	No	No	C
30/08/19 10:24:31	3015:1	Lost Position	No	Yes	W
30/08/19 10:20:25	3113:1	Sync in fallback	No	No	C
30/08/19 10:02:19	3119:3	Missing Heading	No	No	C
30/08/19 09:53:01	OS40...	Proximity Alert	Yes	Yes	W
30/08/19 09:50:25	3013:3	Doubtfull GNSS	Yes	Yes	C
30/08/19 09:30:25	3119:4	Wrong NavStatus	No	Yes	C

Messages in this list are colour coded as follows:

Status	Visual Indication	Audible Signal
Warnings, not acknowledged	Amber, flashing	2 beeps every 15 seconds until acknowledged. Should the Warning remain Active after 5 minutes the Audible Alarm will sound again
Warnings, silenced	Amber, flashing	Silent
Warnings, acknowledged	Amber	Silent
Caution	Yellow	Silent

Select any message in the list and press  to see more information. Then select "Ignore" or "OK".



Identifier	Text	Additional Information	Action
3108	Locating Device	Check AIS Targets	Look for MOB or SART targets
3062	General Fault	Check AIS Equipment	
3008	Transceiver Fail	Not Transmitting - check AIS Not Receiving - check AIS	
3015	Lost Position	Own ship position not transmitted	Check internal and external GPS antennas and connections
3116	Impaired Radio	Reduced Coverage (antenna VSWR) Ch1, Ch2 or DSC inoperative, check AIS	Check VHF antenna and connections
3113	Sync in fallback	Check AIS for UTC time synchronisation	Check internal GPS antennas and connections
3003	Lost Ext EPFS	Check external position sensor	Check the EPFS source
3119	Missing COG or SOG Missing Heading Missing ROT	Not transmitting COG or SOG Not transmitting Heading Not transmitting Rate of Turn	Check internal GPS antennas and connections Check the Compass source Check the ROT source
3031	Doubtful GNSS Doubtful Heading	Int/Ext GNSS Position mismatch Difference with COG exceeds limits	Check external GNSS sources
3019	Wrong Nav Status	Check Nav Status settings	



7.1.5 Status Messages - Messages System Messages

Status Messages :

Received:	MSG Description
30/08/19 12:44:09 034	AIS: Other ROT source in use
30/08/19 11:53:25 027	AIS: external SOG / COG in use
30/08/19 10:24:31 022	AIS: external GNSS in use
30/08/19 10:20:25 025	AIS: internal GNSS in use
30/08/19 10:02:19 027	AIS: external SOG / COG in use
30/08/19 09:53:01 022	AIS: external GNSS in use
30/08/19 09:50:25 028	AIS: internal SOG / COG in use
30/08/19 09:30:25 025	AIS: internal GNSS in use
30/08/19 09:20:15 033	AIS: Rate of Turn Indicator in use

Additional content is added to the Messages Menu :

Delete All

Identifier	Message
21	AIS: external DGNSS in use
22	AIS: external GNSS in use
23	AIS: internal DGNSS in use (beacon)
24	AIS: internal DGNSS in use (Message 17)
25	AIS: internal GNSS in use
27	AIS: external SOG/ COG in use
28	AIS: internal SOG/ COG in use
31	AIS: Heading valid
33	AIS: Rate of Turn Indicator in use
34	AIS: Other ROT source in use
36	AIS: Channel management parameters changed
37	AIS: Low power tanker mode active
38	AIS: Low power tanker mode inactive
40	AIS: Operating in assigned mode by Message 16 from base station 00MIDXXXX
41	AIS: Operating in data link management mode by Message 20 from base station(s) 00MIDXXXX[...]
42	AIS: Operating in channel management mode by Message 22 from base station 00MIDXXXX on channels YYYY and ZZZZ
43	AIS: Operating in group assignment mode by Message 23 from base station 00MIDXXXX
44	AIS: Returned to default operations



8. STATUS

8.1 System

8.1.1 Status - Status System Status

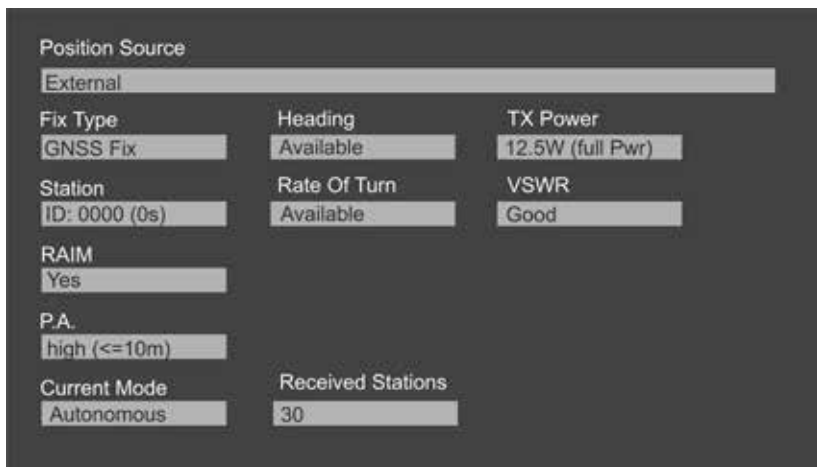

Position Source	Internal / External
Fix Type	No GNSS Fix / GNSS Fix / DGNSS Fix / Other*
Heading	Available / Not available / Disabled
Power	12.5W (Full Power) / 1W (Low Power) / Disabled (Silent)
Station	Not in Use or GNSS correction station details
Rate of Turn	Available / Not available / Disabled
VSWR	Good / Bad
RAIM	Yes / No
P.A.	Position Accuracy: Low (>10m) or High (<=10m)
Current Mode	Autonomous / Assigned**
Received Stations	No. of targets not including Class BCS

* EPFS input only

** Controlled by a Base Station



8.1.2 Info - Status System Info

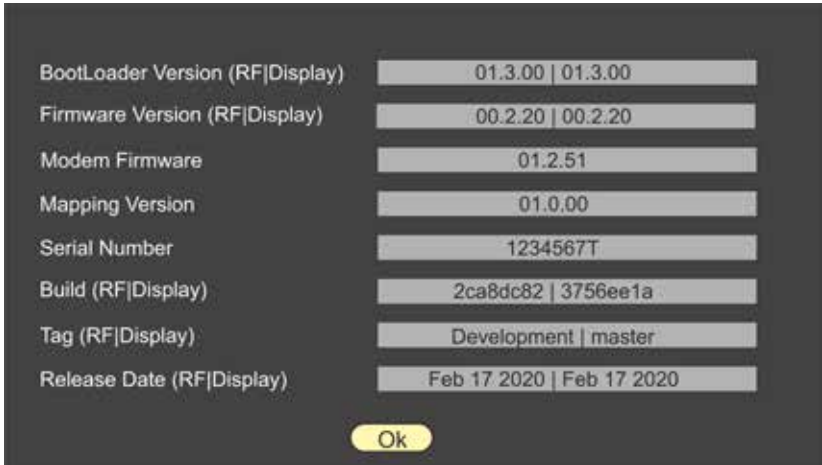

Information about the system may be required during fault finding or inspection. Check on the ACR website (www.acrartex.com) for the latest Firmware version available.

- ! **It is important to make sure the CA2 is kept up to date by checking for Firmware updates. If you have registered the product email notifications will be sent. See section 11.3 of this manual for further information on Firmware updates**

8.1.3 Log - Status System Log

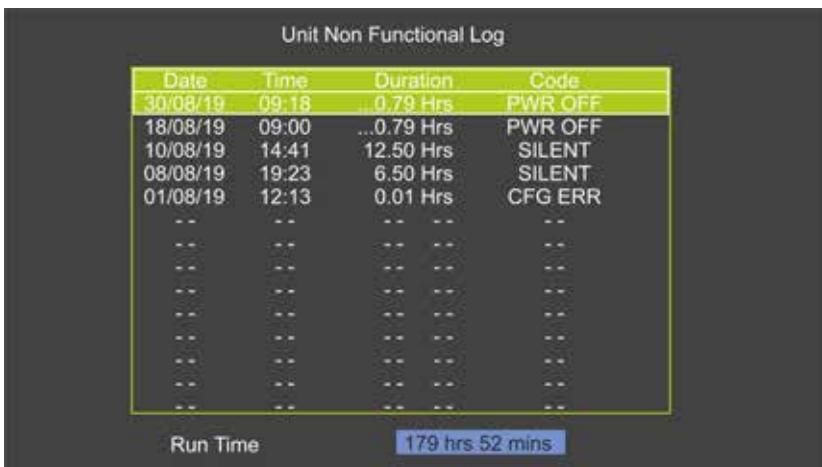



Use to highlight and to select an entry to view further information:

Unit Non Functional Log

Date	Time	Duration	Code
30/08/19	09:18	0.79 Hrs	PWR OFF
18/08/19	09:00	0.79 Hrs	PWR OFF
10/08/19	14:41	12.50 Hrs	SILENT
08/08/19	19:23	6.50 Hrs	SILENT
01/08/19	12:13	0.01 Hrs	CFG ERR
--	--	--	--
--	--	--	--
--	--	--	--
--	--	--	--
--	--	--	--
--	--	--	--
--	--	--	--
--	--	--	--
--	--	--	--
--	--	--	--
--	--	--	--
--	--	--	--
--	--	--	--

Run Time 179 hrs 52 mins

8.2 Ownership Static - Status Ownership Static

MMSI Number	XXXXXXXXXX	IMO Number	N/A	
Name	CLASS A AIS			
Call Sign	CLAAIS			
Vessel Type	Fishing - Type 30			
Max. Draught	3.2	Metres		
	Dimensions			
	A	B	C	D
Internal GNSS	30	4	5	1
External GNSS	30	4	3	3

To change any of these details go to the AIS setup page described on page 37 of this manual.



8.3 Ownship Dynamic - Status Ownship Dynamic

Cargo	0 - Non Hazardous	
Nav. Status	5 - Moored	
Destination	MARGATE	
ETA	Day: - Month: - Hour: - Minute: - UTC	
Current Position	N51°21.84, E001°23.40	
Current Speed	0.0 kn	Course 127°
Current Heading	121°	Rate of turn 0° / min R
Position Source	External GNSS - GPS	
Position Quality	Not Corrected	
Power	12.5W (Full Power)	
CPA	50	TCPA 60

To change any of these details go to the AIS setup page described on page 36 of this manual.

8.4 GNSS Status

8.4.1 Internal GNSS - Status GNSS Status Internal GNSS

Source	GPS
Latitude	N51° 21.84
Longitude	E001° 23.41
Course	183°
Speed	0.0 kn
Fix	GNSS Fix
H-DOP	0.790
V-DOP	1.170
Raim	---
DGNSS	Unknown

Signal Strength

ID:	19	14	6	32	25	12	24	10	15	17	--	--
-----	----	----	---	----	----	----	----	----	----	----	----	----

Use this page to check the quality of the internal GNSS receivers.



8.4.2 External GNSS - Status GNSS Status External GNSS

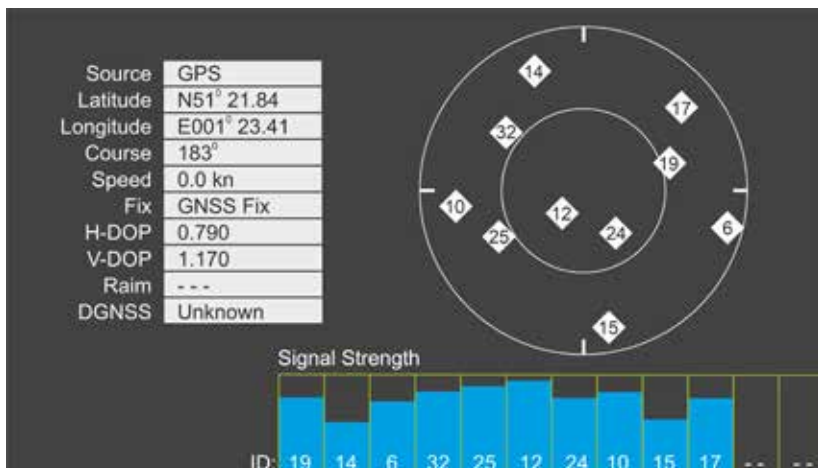

Use this page to check the quality of the external GNSS receivers.

NOTE: Depending on the information being sent by the third party GNSS receiving equipment this page may display limited data.

9. SETTINGS

9.1 Password Protection

There are two passwords available in the CA2, A User Password and an Admin Password. Where passwords are required a pop-up keyboard will be displayed. See the CA2 Installation Guide for information regarding password set-up.



Default passwords:

User - 0000, Admin - 1111



9.2 AIS

9.2.1 Voyage - Settings AIS Voyage

Set the Current/Default Voyage Values

Destination: Default

Default Destination: MARGATE - EMSWORTH

Cargo:

Nav. Status: Default

Default Nav. Status: 0 - Under way using Engine

ETA Don't send the ETA.

CPA: Distance in NM Threat Notification Disabled

TCPA: Time in Minutes Enable Threat Notification

Save

Destination	Enter the destination port name or three letter ID
Cargo	Enter the current cargo being carried
Nav. Status	Select from the list (Press "Default" to save the usual status)
ETA	Enter the Estimated Time of Arrival at the destination port if this information is to be transmitted.
CPA / TCPA	Enter the distance and the Time at which the Closest Point of Approach Alarm will sound
Alert	Click to Enable or Disable the CPA Alarm
Save	

If Navigation status type 12 is selected dimension extension values will be required

Navigation type 12 requires dimension extension values, please enter these now or press cancel to abort

External dimensions:

Port (EC) Bow (EA) Starboard (ED)

Stern (ES)

OK
Cancel

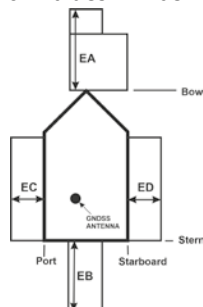



9.2.2 Ownship - Settings AIS Ownship :<Password*>

MMSI Number	Enter the Vessel's MMSI number that has been issued by the radio authorities. This MUST be entered for the AIS to transmit.
IMO Number	Enter the Vessel's registered IMO number. Leave blank if the vessel has no number.
Name	Enter the Vessel's name
Call Sign	Enter the Vessels radio Call Sign.
Vessel Type	Select the vessel type from the drop down list.
Max. Draught	Enter the Vessel's maximum draught.
Internal GNSS	Enter the position of the GNSS antenna that is connected to the CA2 with respect to the vessel.
External GNSS	Enter the position of the GNSS antenna that is connected to the External Position-Fixing Source connected to the CA2.
Save	Click this button to save the details displayed on this page.

* User password allows Vessel Type and Max. Draught only to be changed
Admin password is required to change all other settings



9.2.3 Friends - Settings AIS Friends



Press to view the list and then to select one of the 29 available slots.

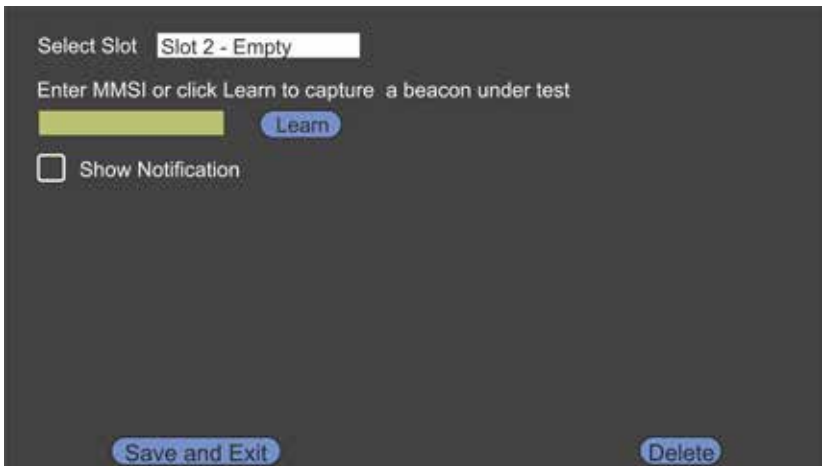
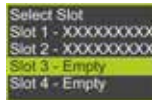

“Friends” may be other vessels in a fleet, particular vessels you wish to know are in range or AIS SART / MOB devices belonging to your vessel.



Press to bring up the pop-up vessel chooser

Enter an MMSI or chose a vessel from the available list and then select "Save and Exit" to store that MMSI number.



Entering any AIS MOB devices will set up the CA2 as a Man Overboard Alarm sounding an audible warning and/or activating the build in relay to trigger a third party indicator or Alarm.

Select "Learn" and press to enter the learn mode.

Carry out a full GPS test on your MOB device and when the signal is received by the CA2 the MMSI number will automatically be added.

It will be necessary to Acknowledge the message Pop-ups that will appear as the signal is received.

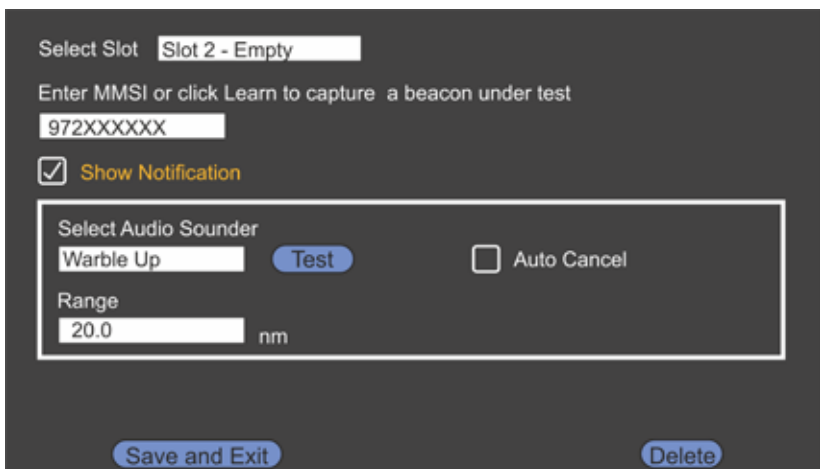

Select the details you wish to associate with this MMSI number and press "Save and Exit" to store the details.



9.2.4 Regions - Settings AIS Regions

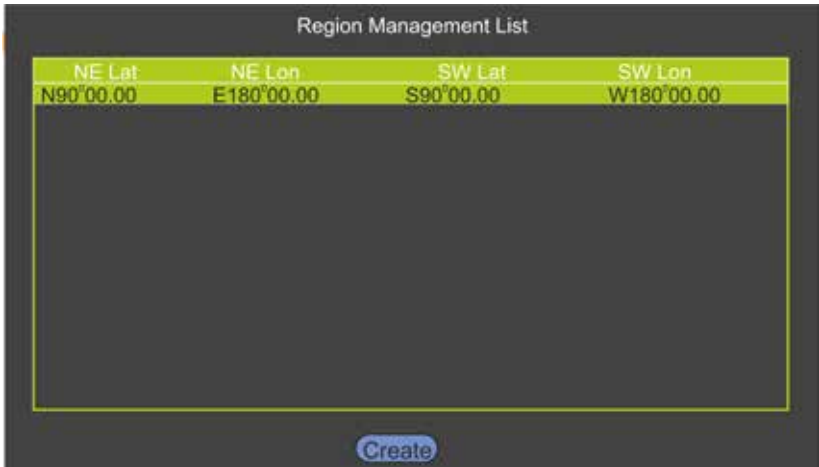

Here individual operation modes for specific regions can be set. Region setting can be entered by the following:

- Input Port (ie. Pilot Port)
- Base Station
- DSC Message
- Manually

Create to manually enter a region

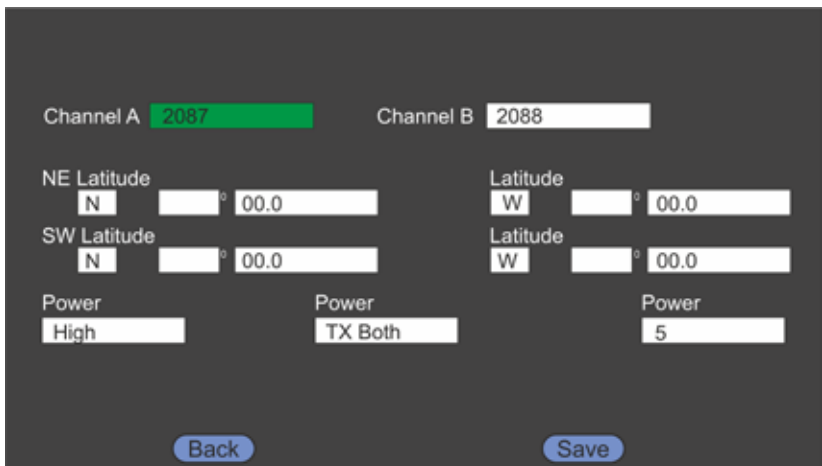

The default region is "Open Seas" and when there are multiple regions listed the active



region is marked in Green.

9.3 System

9.3.1 General - Settings System General

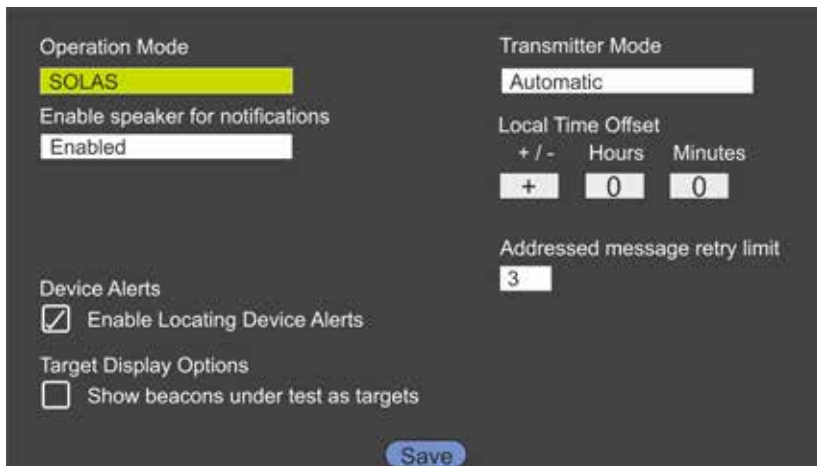

Default settings are marked in **bold**.

Operation Mode	SOLAS / Inland Waterways
Enable speaker for notifications	Enabled / Disabled When disabled the internal speaker will not sound regardless of any other selections.
Device Alerts	<input type="checkbox"/> (Off) / <input checked="" type="checkbox"/> (On)
Target Display Options	<input type="checkbox"/> (Off) / <input checked="" type="checkbox"/> (On)
Transmitter Mode	Automatic / Low Power Mode / Silent Mode
Local Time Offset	Default is + 0 Hours 0 Minutes where time is shown as UTC.
Addressed message retry limit	0 / 1 / 2 / 3
Save	Click to save changes on this page



9.3.2 Audio Alerts - Settings System Audio Settings

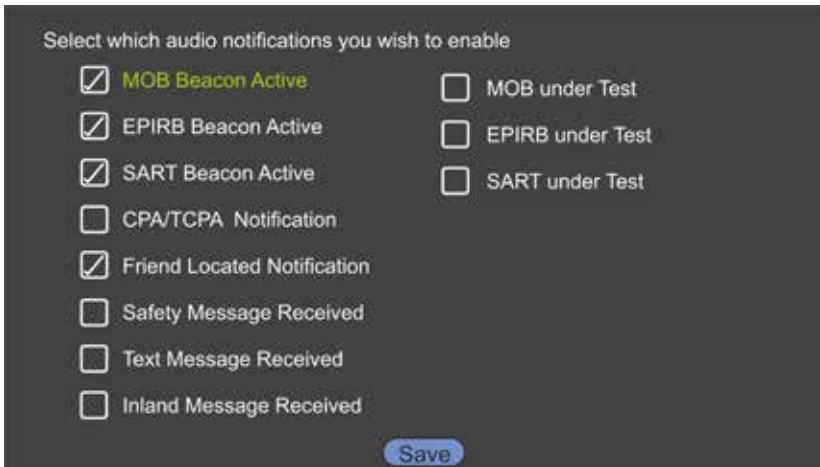

Select the alarms that you wish to trigger the built in audio speaker.

9.3.3 WiFi - Settings System WiFi

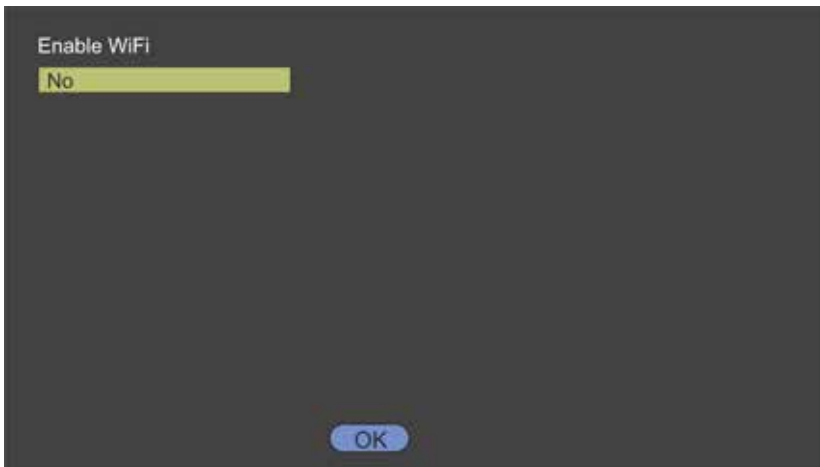



The CA2 has WiFi built in to allow connection to navigation software on WiFi capable computers, tablets and mobile phones.



Direct Connection - Devices connect directly to the CA2

Enter the SSID to be visible to other devices, select a WiFi Channel and enter a password.
DEFAULT: SSID: CA2-AIS DEFAULT PASSWORD: ACRELECTRONICS

Network Connection - The CA2 connects to an existing WiFi Network

The CA2 will search for available networks, enter the password that allows access to the selected networks router,  Connect 

When the CA2 connects to the network, the IP address selected will be displayed. Make a note of this so that you can connect other devices.



10. GLOSSARY AND ABBREVIATIONS

AIS	Automatic Identification System	LED	Light Emitting Diode
AtoN	Aid to Navigation	LEN	Load Equivalence Number
AWG	American Wire Gauge	LRM	Long Range Messaging
BRG	Bearing	MED	Marine Equipment Directive
COG	Course Over Ground	MFD	Multi-Function Display
CPA	Closest Point of Approach	MMSI	Maritime Mobile Service Identity
DSC	Digital Selective Calling	MOB	Man Over Board
ECDIS	Electronic Chart Display and Information System	NMEA	National Marine Electronics Association
ENI	Electronic Navigation Industries	PGN	Parameter Group Number
EPFS	Electronic Position Fixing System	RAIM	Receiver Autonomous Integrity Monitoring
ETA	Estimated Time of Arrival	RNG	Range
EU	European Union	ROT	Rate of Turn
FCC	Federal Communications Commission	RTCM	Radio Technical Commission for Maritime
GLONASS	Global Navigation Satellite System	SART	Search And Rescue Transponder
GNSS	Global Navigation Satellite System	SOLAS	Safety of Life at Sea
GPS	Global Positioning Satellite	TCPA	Time to Closest Point of Approach
HDG	Heading	USB	Universal Serial Bus
IMO	International Maritime Organization	VHF	Very High Frequency
LCD	Liquid Crystal Display	VSWR	Voltage Standing Wave Ratio

11. MAINTENANCE

11.1 Product Cleaning

- Lightly rinse or flush with clean, cool fresh water.
- Do NOT wipe the screen with a dry cloth, as this could scratch the window.
- Do NOT use: abrasive, acidic, ammonia, solvent or chemical based cleaning products.
- Do NOT use a jet wash.



11.2 Service and Maintenance

This product contains no user serviceable components. Please refer all maintenance of the product to ACR Electronics. Unauthorised repair may affect your warranty.

! FCC Warning (Part 15.21)

Changes or modifications to this equipment not expressly approved in writing by ACR could violate compliance with FCC rules and void the user's authority to operate the equipment.

11.3 Firmware Updates

Ocean Signal reserves the right to produce Firmware updates as required. These updates will be made available to download from www.oceansignal.com and will be accompanied with relevant documentation including updated User Manuals.

11.3.1 To update Firmware

Download the relevant file and copy it to a blank USB stick. Power down the CA2 and use the supplied USB on-the-go cable to connect the USB stick to the USB port on the front of the unit. Power on the CA2 and the firmware will be loaded into the unit automatically with progress reported visually on the screen. On completion power down the CA2 and remove the USB on-the-go cable before powering up once more.

Firmware versions loaded can be viewed:

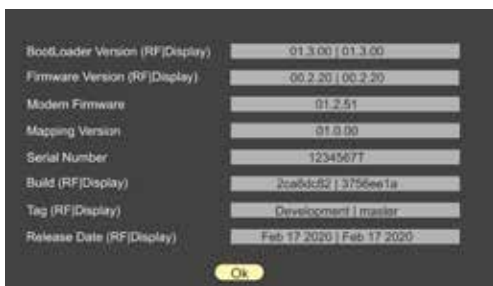



11.4 Routine equipment checks

It is recommended that you perform the following routine checks, on a regular basis, to ensure the correct and reliable operation of this equipment:

- Examine all cables for signs of damage or wear and tear.
- Check that all cables are securely connected.

12. APPROVALS

12.1 EU Marine Equipment Directive

The CA2 is approved under the EU Marine Equipment Directive under MED/4.32 of the current implementing regulation. The Declaration of Conformity can be downloaded from: www.acrartex.com/support/acr-support/acr-declaration-of-conformity/

12.2 United States of America

This device complies with part 15 of the FCC Rules. Operation is subject to the following two conditions:

- This device may not cause harmful interference
- This device must accept any interference received, including interference that may cause undesired operation.

12.3 Canada

This AIS class A digital apparatus complies with Canadian ICES-003.



13. SPECIFICATIONS

Transmitter

Transmit Power 12.5/1Watts
 Frequency Range 156.025 – 162-025MHz
 Modulation AIS GMSK: BT 0.4
 DSC FSK: Mod Index 2

Receiver

Sensitivity -107dBm for 20% packet error rate
 Frequency Range AIS RX1 and RX2 156.025 – 162.025MHz
 DSC 156.525MHz

General

Dimensions 214 x 211 x 150mm (8.5" x 8.3" x 5.9")
 Nominal viewing distance 0.5m (20")
 Temperature Range -15°C to +55°C (5°F to 131°F)
 Waterproof IPx7 (1metre for 30 minutes)
 Equipment Category (Display Unit) Protected
 Equipment Category (GPS Antenna) Exposed
 Supply Voltage Range 9.6V to 31.2V
 GPS Receiver High sensitivity
 Channels 99 acquisition/33 tracking
 Interfaces
 Serial ports IEC61162-1, -2
 3 Rx only, 3 Rx/Tx, Pilot plug
 USB¹
 Blue switch input Isolated
 Alarm Relay Normally Open/Normally closed: 2A max.

Compliance

Standards IEC61993-2, IEC60945, IEC62288²

¹ For maintenance/configuration

² AIS operation only

14. SPARES AND ACCESSORIES

Part Number	Description
ACR-9624	GNSS Antenna (with 10m cable)
ACR-9626	USB On-The-Go Cable
ACR-9627	USB A to USB Micro Cable
761S-03342	Connector Kit
761S-02758	Pilot Plug Cover
761S-03498	Display Mounting Foot
761S-02760	Cable Support and Seal Kit



AISLink™ CA2

ACR ELECTRONICS, INC.
5757 Ravenswood Rd.
Fort Lauderdale, Florida
33312 - USA