

Ekrano GX Manual

Table of Contents

1. Safety instructions	1
2. Introduction	2
2.1. What is the Ekranó GX?	2
2.2. What's in the box?	2
3. Installation	4
3.1. Ekranó GX Overview of connections	4
3.2. Mounting options	5
3.3. Powering the Ekranó GX	6
3.4. Built-in 7-inch Touchscreen	7
3.5. Deactivating touch input control	8
3.6. Relay connections	10
4. The User Interface	11
4.1. User interface introduction	11
4.2. The Brief Page	12
4.3. The Overview Page	13
4.4. The Settings menu	13
4.5. Data units	14
4.6. The Switch pane	15
4.7. The Boat Page	17
4.7.1. Compatible systems	17
4.7.2. How to integrate	18
4.7.3. Integration examples	18
4.7.4. Configuration & GX device monitoring	20
4.7.5. CANopen integration for electric propulsion systems	21
4.7.6. Multihull / dual engine setup support	21
4.7.7. VRM Monitoring	22
4.8. The Support status (modification checks) page	23
4.9. Network security profile	24
5. Connecting Victron products	25
5.1. VE.Bus Multis/Quattros/Inverters	25
5.2. AC load monitoring	27
5.3. Battery monitors, MPPTs, Orion XS and Smart IP43 Chargers with a VE.Direct port	27
5.3.1. DC load monitor mode	28
5.4. VE.Can Devices	29
5.5. VE.Can Interfaces	29
5.6. Inverter RS, Multi RS and MPPT RS	30
5.7. BMV-600 series	30
5.8. DC Link Box	30
5.9. VE.Can Resistive Tank Sender Adapter	30
5.10. Connecting a GX Tank 140	31
5.11. Connecting hardwired Victron temperature sensors	32
5.12. Victron Energy Meter VM-3P75CT	33
5.13. EV Charging Station	34
5.14. GX IO-Extender 150	35
6. Connecting supported non-Victron products	37
6.1. Connecting a PV Inverter	37
6.2. Connecting a USB GPS	37
6.3. Connecting a NMEA 2000 GPS	38
6.4. Connecting Tank Level Sensors to the GX Tank Inputs	39
6.5. Increasing the number of tank inputs by using multiple GX devices	41
6.5.1. Introduction	41
6.5.2. Requirements	41
6.5.3. Configuration step-by-step	42
6.6. Connecting third-party NMEA 2000 tank senders	42
6.7. Bluetooth connectivity requirements	44
6.8. Mopeka Ultrasonic Bluetooth Sensors	45
6.8.1. Installation	45

6.8.2. Configuration	45
6.8.3. Tank level monitoring	47
6.9. Safier Star-Tank tank level sensor	48
6.9.1. Installation	48
6.9.2. Configuration	49
6.9.3. Tank level monitoring	49
6.10. Gobius Bluetooth tank sensor support	50
6.10.1. Installation	50
6.10.2. Configuration	51
6.10.3. Tank level monitoring	52
6.11. Wireless Bluetooth Ruuvi temperature sensors	53
6.12. Ruuvi Air support	54
6.12.1. Installation	54
6.12.2. Configuration	55
6.12.3. Monitoring	55
6.13. Connecting IMT Solar Irradiance, Temperature and Wind Speed Sensors	56
6.14. Connecting a SmartSwitch DC4	59
6.15. Shelly Energy Meters & Switches support	61
6.15.1. Installation	62
6.15.2. Configuration	62
6.15.3. Monitoring	64
6.16. Garmin EmpirBus digital switching support	64
6.17. Reading generic alternator data from compatible NMEA 2000 DC sensors	65
6.17.1. Wakespeed WS500 alternator regulator support	66
6.17.2. Arco Zeus Alternator Regulator support	70
6.17.3. Revatek Altion Alternator Regulator Support	71
6.18. CANopen E-drive support	71
6.18.1. How to connect the Sevcon controller to a GX device	73
6.18.2. How to connect a Curtis F series controller to a Victron GX device	74
6.18.3. How to connect a Curtis E/SE series controller to a Victron GX device	75
6.18.4. How to configure the Victron GX device	75
7. Internet connectivity	77
7.1. Ethernet LAN port	77
7.2. WiFi	78
7.3. GX LTE 4G	78
7.4. Using a mobile router	79
7.5. Manual IP configuration	79
7.6. Multiple network connections (failover)	80
7.7. Minimise internet traffic	81
7.8. More information on setting up an internet connection and VRM	81
8. Accessing the GX device	82
8.1. Using VictronConnect via Bluetooth	83
8.2. Accessing via built-in WiFi Access Point	84
8.3. Accessing the Remote Console via local LAN/WiFi Network	85
8.3.1. Alternative methods to find the IP address for Remote Console	85
8.4. Accessing via VRM	86
9. Configuration	87
9.1. Menu structure and configurable parameters	87
9.2. Battery state of charge (SoC)	97
9.2.1. Which device should I use for SoC calculation?	97
9.2.2. Notes on SoC	97
9.2.3. Selecting SoC source	98
9.2.4. Details on VE.Bus SOC	98
9.2.5. The System Status menu	99
9.3. Temperature relay configuration	100
9.3.1. Heating & cooling control for batteries	101
10. Firmware updates	102
10.1. Changelog	102
10.2. Firmware update methods	102
10.2.1. Direct download from the internet	102
10.2.2. MicroSD-card or USB-stick	103
10.3. Revert to a previous firmware version	103

10.3.1. Stored firmware backup feature	103
10.3.2. Install a specific firmware version from SD/USB	104
10.4. Venus OS Large image	104
11. VE.Bus Inverter/charger monitoring	105
11.1. Grid Current Limit Setting	105
11.2. Phase rotation warning	106
11.3. BMS connection lost alarm	106
11.4. Grid failure monitoring	106
11.5. Advanced menu	107
11.6. Alarm status monitoring	107
11.7. VE.Bus alarm setup menu	108
11.8. Device menu	108
11.9. VE.Bus Settings Backup & Restore	109
11.10. Solar & Wind Priority	109
12. DVCC - Distributed Voltage and Current Control	111
12.1. Introduction and features	111
12.2. DVCC Requirements	113
12.3. DVCC effects on the charge algorithm	114
12.3.1. DVCC effects when there is more than one Multi/Quattro connected	115
12.4. DVCC features for all systems	116
12.4.1. Limit charge current	116
12.4.2. Limit managed battery charge voltage	116
12.4.3. Shared Voltage Sense (SVS)	117
12.4.4. Shared Temperature Sense (STS)	117
12.4.5. Shared Current Sense (SCS)	117
12.4.6. Controlling BMS	118
12.5. DVCC features when using CAN-bus BMS battery	118
12.6. DVCC for systems with the ESS Assistant	119
13. VRM Portal	120
13.1. VRM Portal introduction	120
13.2. Registering on VRM	120
13.3. Datalogging to VRM	121
13.4. Troubleshooting data logging	122
13.5. Analysing data offline (without VRM)	125
13.6. Access settings for Remote Console & Controls pane in VRM	125
13.7. Remote Console on VRM - Troubleshooting	126
14. Marine MFD integration by App	127
14.1. Introduction & requirements	127
14.2. Raymarine MFD Integration	128
14.2.1. Introduction	128
14.2.2. Compatibility	128
14.2.3. Wiring	128
14.2.4. GX device configuration	129
14.2.5. Configuring Multiple Tank Level Measurements (Raymarine)	129
14.2.6. Installation step-by-step	130
14.2.7. NMEA 2000	131
14.2.8. Generic and supported PGNs	131
14.2.9. Instancing requirements when using Raymarine	131
14.2.10. Before LightHouse 4.1.75	131
14.2.11. LightHouse 4.1.75 and newer	132
14.3. Navico MFD Integration	132
14.3.1. Introduction	132
14.3.2. Compatibility	132
14.3.3. Wiring	133
14.3.4. GX device configuration	133
14.3.5. Configuring Multiple Tank Level Measurements (Navico)	133
14.3.6. Installation step-by-step	134
14.3.7. NMEA 2000	135
14.3.8. Generic and supported PGNs	135
14.3.9. Troubleshooting	135
14.4. Garmin MFD Integration	135
14.4.1. Introduction	135

14.4.2. Compatibility	136
14.4.3. Wiring	136
14.4.4. GX device configuration	137
14.4.5. Configuring Multiple Tank Level Measurements (Garmin)	137
14.4.6. Installation step-by-step	138
14.4.7. NMEA 2000	139
14.4.8. Generic and supported PGNs	139
14.5. Furuno MFD Integration	139
14.5.1. Introduction	139
14.5.2. Compatibility	139
14.5.3. Wiring	140
14.5.4. Configuration	140
14.5.5. Configuring Multiple Tank Level Measurements (Furuno)	141
14.5.6. NMEA 2000	141
14.5.7. Generic and supported PGNs	141
15. Marine MFD integration by NMEA 2000	143
15.1. NMEA 2000 Introduction	143
15.2. Supported Devices / PGNs	143
15.3. NMEA 2000 Configuration	145
15.4. Configuring Multiple Tank Level Measurements (Raymarine)	145
15.5. Configuring Multiple Tank Level Measurements (Garmin)	146
15.6. Configuring Multiple Tank Level Measurements (Navico)	147
15.7. Configuring Multiple Tank Level Measurements (Furuno)	150
15.8. NMEA2000-out technical details	150
15.8.1. NMEA 2000 Glossary	150
15.8.2. NMEA 2000 Virtual-devices	151
15.8.3. NMEA 2000 Classes and Functions	151
15.8.4. NMEA 2000 Instances	151
15.8.5. NMEA 2000 Changing Instances	152
15.8.6. PGN 60928 NAME Unique Identity Numbers	157
16. RV-C Support	158
16.1. RV-C Introduction	158
16.2. Limitations	158
16.3. Supported Devices	159
16.4. RV-C Configuration	160
16.4.1. Configuration of RV-C out devices	161
16.5. Garnet SeeLevel II 709-RVC & Victron GX device support	162
16.5.1. Wiring the Garnet SeeLevel II 709-RVC tank level sensor to a GX device	162
16.5.2. Installation and configuration	162
17. Digital Inputs	163
17.1. Configuration	163
17.2. Read-out of digital inputs via Modbus TCP	164
18. GX - Generator auto start/stop	165
18.1. Introduction	165
18.2. How to integrate	165
18.2.1. Relay-controlled start/stop signal	166
18.3. Generator start/stop menu	167
18.4. Settings menu	168
18.4.1. Alarm when autostart function is disabled	168
18.4.2. Run time and service interval menu	169
18.4.3. Warm-up & cool-down menu	169
18.5. Auto start/stop conditions	170
18.5.1. Stop generator when AC-input is available	170
18.5.2. Start/Stop based on Battery SoC	171
18.5.3. Start/Stop based on Battery Voltage	172
18.5.4. Start/Stop based on AC load	172
18.5.5. Start/Stop based on Inverter High temperature	172
18.5.6. Start/Stop based on Inverter overload	173
18.5.7. Start/stop based on tank level	173
18.5.8. Periodic run	173
18.5.9. Manual Start Feature	174
18.5.10. Quiet hours	175

18.6. ComAp controller	176
18.6.1. Introduction	176
18.6.2. Requirements	176
18.6.3. Installation & Configuration	176
18.7. CRE Technology controller	180
18.7.1. Introduction	180
18.7.2. Requirements	180
18.7.3. Installation & Configuration	180
18.8. DSE- Deep Sea generator controller support	181
18.8.1. Introduction	181
18.8.2. Requirements	181
18.8.3. Installation & Configuration	181
18.9. DEIF controller	182
18.9.1. Introduction	182
18.9.2. Requirements	182
18.9.3. Installation & Configuration	182
18.10. Fischer Panda Generator support	184
18.10.1. Introduction	184
18.10.2. Requirements	184
18.10.3. Installation and configuration	185
18.10.4. GX device configuration and monitoring	186
18.10.5. Maintenance	187
18.11. Hatz fiPMG DC Generator	188
18.11.1. Introduction	188
18.11.2. Requirements	188
18.11.3. Installation & Configuration	188
18.11.4. Maintenance	189
18.11.5. Troubleshooting	189
18.12. Generator state and improved operating hours via a digital input	190
18.13. Wiring a generator with a three-wire interface	190
19. Reset to factory defaults and Venus OS reinstall	191
19.1. Reset to factory defaults procedure	191
19.2. Venus OS reinstall	192
20. Troubleshooting	193
20.1. Error Codes	193
20.2. FAQ	194
20.2.1. Q1: I cannot switch my Multi/Quattro system on or off	194
20.2.2. Q2: Do I need a BMV to see proper battery state of charge?	194
20.2.3. Q3: I have no internet. Where can I insert a SIM card?	194
20.2.4. Q4: Can I connect both a GX Device and a VGR2/VER to a Multi/Inverter/Quattro?	194
20.2.5. Q5: Can I connect multiple Ekrano GX to a Multi/Inverter/Quattro?	194
20.2.6. Q6: I see incorrect current (amps) or power readings on my EGX	195
20.2.7. Q7: There is a menu entry named "Multi" instead of the VE.Bus product name	195
20.2.8. Q8: There is a menu entry named "Multi", while there is no Inverter, Multi or Quattro connected ..	195
20.2.9. Q9: When I type the IP address of the Ekrano GX into my browser, I see a web page	
mentioning Hiawatha?	195
20.2.10. Q10: I have multiple Solar chargers MPPT 150/70 running in parallel. From which one will I	
see the relay status in the EGX menu?	195
20.2.11. Q11: How long should an automatic update take?	196
20.2.12. Q12: I have a VGR with IO Extender, how can I replace this with a Ekrano GX?	196
20.2.13. Q13: Can I use Remote VEConfigure, as I was doing with the VGR2?	196
20.2.14. Q14: The Blue Power Panel could be powered through the VE.Net network, can I also do that	
with a Ekrano GX?	196
20.2.15. Q15: What type of networking is used by the Ekrano GX (TCP and UDP ports)?	196
20.2.16. Q16: What is the functionality behind the menu item Remote support in the General menu?	197
20.2.17. Q17: I don't see support for VE.Net products in the list, is that still coming?	197
20.2.18. Q18: What is the data usage of the Ekrano GX?	197
20.2.19. Q19: How many AC Current Sensors can I connect in one VE.Bus system?	197
20.2.20. Q20: Issues with Multi not starting when EGX is connected / Caution when powering the EGX	
from the AC-out terminal of a VE.Bus Inverter, Multi or Quattro	197
20.2.21. Q21: I love Linux, programming, Victron and the EGX. Can I do more?	198
20.2.22. Q23: Multi restarts all the time (after every 10sec)	198
20.2.23. Q24: What is Error #42?	198
20.2.24. Q25: My GX device reboots itself. What is causing this behavior?	198
20.2.25. GPL Note	199

21. Technical specifications	200
21.1. Technical specifications	200
21.2. Network Interfaces and Communication Services (RED 3.3d / EN 18031-1)	202
21.3. Compliance	202
22. Appendix	203
22.1. RV-C	203
22.1.1. Introduction to RV-C	203
22.1.2. RV-C out	203
22.1.3. DGN 60928 Unique Identity Numbers	212
22.1.4. RV-C in	212
22.1.5. Device Classes	212
22.1.6. Instance Translation	213
22.1.7. RV-C Fault and Error Handling	213
22.1.8. RV-C Device Priority	214
22.2. Ekrano GX Dimensions	215
22.3. Ekrano GX cut-out template	215
22.4. Modbus holding registers for the ComAp IntelliLite 4 controller	216
22.5. Modbus holding registers for supported DSE genset controllers	217

1. Safety instructions



SAVE THESE INSTRUCTIONS – This manual contains important safety and operating guidelines that must be followed during installation, setup, use, and maintenance.

- Read this manual carefully before installing or using the product.
- Always ensure you are using the latest version of the manual. The most recent version is available on the [product page](#).
- Install the product in a heat-resistant environment. Keep it away from chemicals, plastic parts, curtains, textiles, or other flammable materials.
- Use the equipment only under the specified operating conditions. Do not operate it in wet or damp environments.
- Never use the product in areas where gas or dust explosions may occur.
- This device must not be used by individuals (including children) with reduced physical, sensory, or mental capabilities, or lack of experience and knowledge, unless supervised or properly instructed.



The GX device must be installed in a location where it is not accessible to unauthorised persons.

2. Introduction

2.1. What is the Ekrano GX?

The Ekrano GX (EGX) is the latest addition to the [GX product family](#), Victron's advanced communication centre for energy systems. It features a built-in 7-inch touchscreen display and extensive connectivity options, allowing full system monitoring and control. The Ekrano GX is the direct successor to the Color Control GX (CCGX).

GX devices can be placed at the core of any Victron energy installation. They run the Venus OS operating system and ensure seamless communication between all connected components, including inverter/chargers, solar chargers, DC-DC chargers and batteries.

You can monitor and control your system:

- Remotely, via the [Victron Remote Management \(VRM\) portal](#) using an internet connection (see [Accessing via VRM \[86\]](#))
- Locally, via:
 - The [Built-in 7-inch Touchscreen \[7\]](#)
 - A web browser (see [Accessing the Remote Console via local LAN/WiFi Network \[85\]](#))
 - An Android tablet or phone as a dedicated display (see [Android GX WiFi Display](#))
 - A Multi-Functional Display (MFD) (see [Marine MFD integration by App \[127\]](#))
 - The [VictronConnect app](#) over LAN, WiFi, or Bluetooth (where applicable)
 - The built-in [WiFi Access Point \[84\]](#)

The [Remote Console \[11\]](#) provides a central user interface for system monitoring and configuration, accessible both locally and remotely.

The EGX also supports [VRM: Remote firmware updates](#) and allows remote configuration changes.

Note: This manual refers to the latest firmware version. You can check the current version via the Device menu under Settings → General → Firmware (see the [Firmware updates \[102\]](#) chapter). If your GX device is not connected to the internet, the latest firmware can be downloaded from [Victron Professional](#).

2.2. What's in the box?

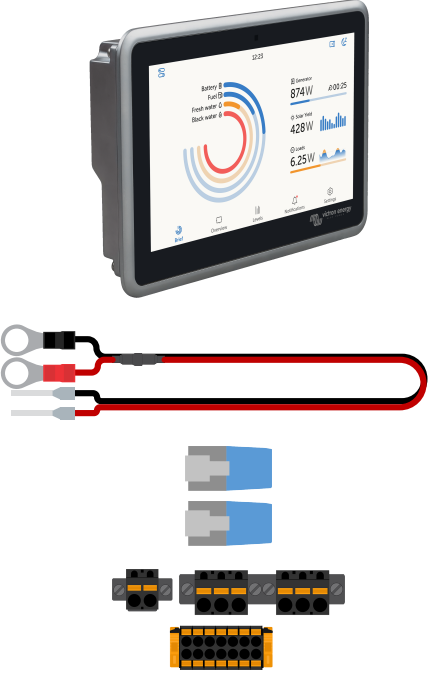
<p>Ekrano GX</p> <p>Power cable with 3.15A inline fuse and M8 terminal eyes for battery or DC busbar-attachment</p> <p>VE.Can terminators (2 pcs)</p> <p>Terminal blocks with mounting screws for: Relays (2 pcs), Power Connector</p> <p>IO terminal block with quick release clamps</p> <p>Mounting material:</p>	
---	--

Steel bracket for panel mount incl. rods, wingnuts and washers

Springs for panel blind hole mount incl. screws and washers

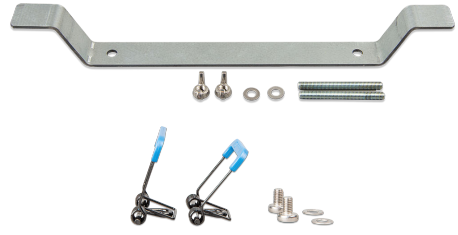

3. Installation

3.1. Ekrano GX Overview of connections

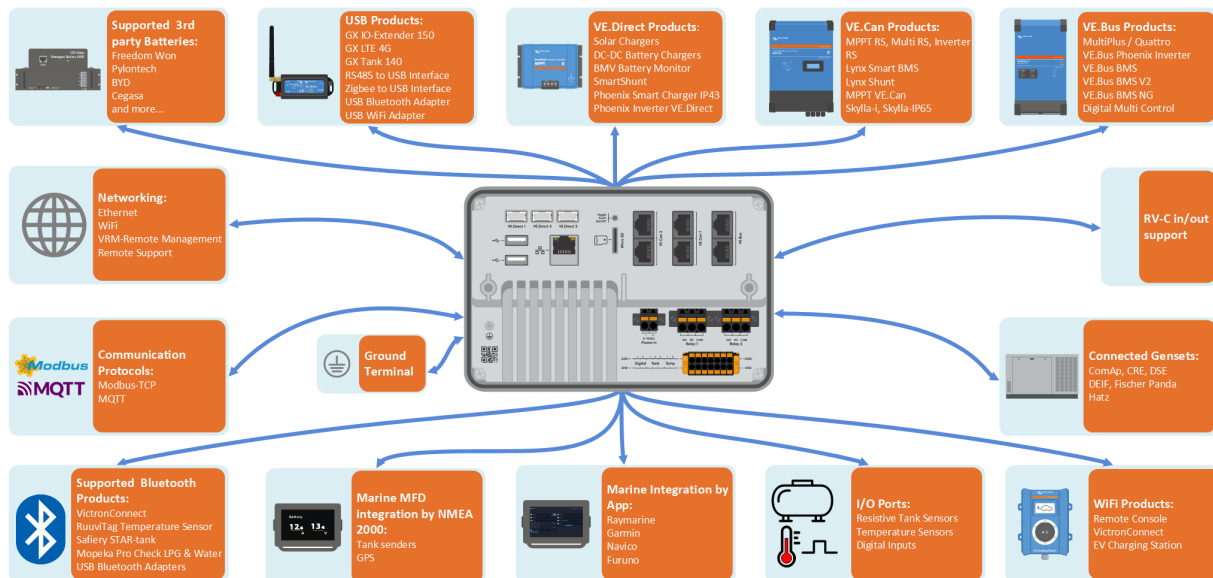

Communication ports	IO	Other
3x VE.Direct	2x Digital Inputs	MicroSD Card Slot (max. 32GB)
2x VE.Can	3x Resistive Tank Level Inputs	Recessed Button for Touch Control
1x VE.Bus	2x Temperature Sensor Inputs	Power Supply Port (8 - 70VDC)
Ethernet	2x Programmable Relay (NO, COM, NC - current limit: DC up to 30VDC: 3A / AC 125VAC: 1A))	7-inch TFT LCD Touchscreen (1024x600 pixels)
WiFi 2.4GHz (802.11 b/g/n)		Ground terminal to connect Protective bonding conductor
Bluetooth Smart		
2x USB Host Ports (current limit: 1.5 A @ 5 V shared)		

The Ekrano GX supports a maximum of 25 VE.Direct devices, regardless of whether they are connected via VE.Direct ports or USB. However, this limit may be lower in complex systems, for example, those with multiple PV inverters or synchronised inverters. Always include some headroom in your system design to ensure reliable operation.

3.2. Mounting options

The Ekrano GX comes with a solid steel bracket, two rods and wingnuts for mounting from the back and an option to mount from the front only, using the attached springs.

Mounting from the back

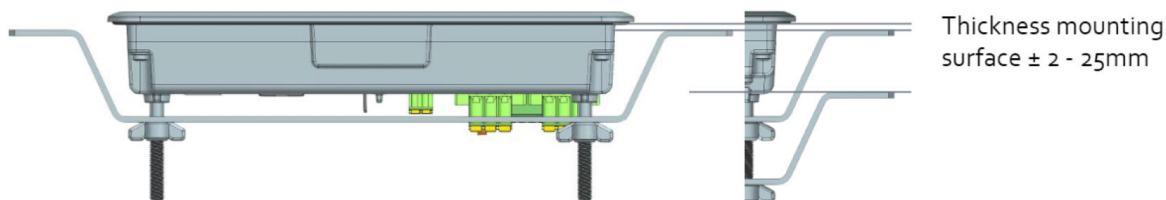

Mount the Ekrano GX from the back when it is easily accessible.

1. Prepare the cut-out as per the [cut-out template](#) from the appendix.
2. Screw the supplied M5 studs with the short threaded end into the rear threads.
3. Place the EGX in the cut-out and mount the steel bracket with the wing nuts provided.
4. Tighten the wing nuts. When done correctly, this squeezes the seal to the surface around the cut-out, making it watertight.

Mounting from the the front



Mount the Ekrano GX from the front if it is not accessible via the back.

1. Prepare the cut-out as per the [cut-out template](#) from the appendix.
2. Mount the supplied springs using the two screws with washers.
3. Make all necessary cable connections.
4. Push the springs carefully back and hold them with your fingers while inserting the EGX into the cut-out. Then release the springs. They will snap back once the EGX is fully inserted and hold the device in place. Be careful as those springs are strong and it hurts really bad when they accidentally snap onto your fingers.

Mounting position

Even though the Ekrano GX is watertight from the front (when using the steel bracket) and has a bright backlight, do not to mount it in direct sunlight to prevent overheating and to gain better readability. Mount it horizontally. Portrait mode or automatic rotation is not supported.

3.3. Powering the Ekrano GX

The device is powered via the *Power in V+* connector and accepts 8 to 70V DC. It cannot be powered through any other connection (e.g. Ethernet or USB). The supplied DC power cable includes an inline 3.15 A slow-blow fuse.

Powering with a VE.Bus BMS

When using the EGX in an installation with a VE.Bus BMS, connect the *Power in V+* terminal on the EGX to the '*Load disconnect*' terminal on the VE.Bus BMS. Connect both negative leads to the negative busbar or common battery negative. This is not necessary for the VE.Bus BMS V2 and VE.Bus BMS NG, as both feature a GX-Power output.

Important: Powering from the AC-out terminal of a VE.Bus Inverter, Multi or Quattro

Powering the GX device with an AC adapter connected to the AC-out of a VE.Bus device (e.g. Inverter, Multi, or Quattro) can cause a deadlock:

- After a fault or black start, the VE.Bus devices will not boot because the EGX is unpowered.
- The EGX cannot boot because the inverter/charger is off, causing a cycle.

Temporary workaround:

Briefly unplug the VE.Bus cable from the GX device to allow the VE.Bus products to restart.

Permanent solution:

Modify the RJ45 cabling. See [FAQ Q20 \[197\]](#) for more information about this.

Recommendation:

Avoid powering the GX device from the AC-out of an inverter/charger. In the event of a shutdown due to inverter overload, high temperature, or low battery voltage, the GX device will also shut down, losing all monitoring and remote access. It is strongly recommended to power the GX device directly from the battery.

Isolation considerations

The GX device connects to various system components. To prevent ground loops, ensure appropriate isolation practices are followed. In most cases, this is not an issue, but proper system design remains essential.

Port type	Cerbo GX	Cerbo GX MK2	Ekrano GX	Venus GX
VE.Bus	Isolated	Isolated	Isolated	Isolated
VE.Direct	Isolated	Isolated	Isolated	Isolated
VE.Can	Not isolated	1)	1)	Isolated
USB ³⁾	Not isolated	Not isolated	Not isolated	Not isolated
Ethernet ²⁾	Isolated	Isolated	Isolated	Isolated

¹⁾ VE.Can port 1 is galvanically isolated, VE.Can port 2 is non-isolated

²⁾ The Ethernet port is isolated, except for the shield: use unshielded UTP cables for the Ethernet network.

³⁾ USB ports are not isolated. Connecting a WiFi dongle or GPS dongle does not create any problems, as these devices are not powered by an external supply. Even when using a separately powered USB hub, a ground loop may occur. However, extensive testing has shown that this does not cause operational issues.

Extending USB Ports

The number of USB ports can be expanded using a USB hub. However, the onboard USB ports have limited power availability.

Recommendation

Always use powered USB hubs and select high-quality products to minimise issues.

To increase the number of VE.Direct devices, you can use a VE.Direct to USB adapter. [Please see this document](#) for the limit of how many devices can be attached to various different GX devices.

3.4. Built-in 7-inch Touchscreen

The integrated 7-inch touchscreen display provides an instant overview of your system and allows real-time adjustment of settings. Its super slim, waterproof design and simple installation offer flexibility for creating a clean, uncluttered dashboard.

No configuration is required; when connected, the device automatically displays the GX overview and menu controls.

Display options

Display settings are available under: Settings → Display & Language

Options include:

- Setting a timeout before the display turns off
- Enabling adaptive brightness based on ambient light

Touchscreen operation

- The screen is controlled by fingertip gestures.
- Swipe to scroll up and down through menus.
- Tap to make selections.
- Text and numerical input is entered using the onscreen keyboard.

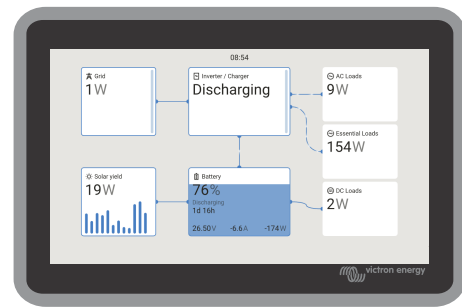

3.5. Deactivating touch input control

To restrict access to the GX system, it is possible to disable touch input control for the touchscreen. This allows the Ekran GX to be installed in view of the operator, while preventing unauthorised interaction or elevation of access levels via the touchscreen.

Note that this feature only disables touch/mouse control. On the Remote Console, you are still able to control the device with keyboard input.

There are three ways to disable the touch function of the display:

1. Using the recessed button on the back
2. Using a momentary push button wired to one of the digital inputs
3. By using an external USB keyboard connected to the Ekran GX; The touch function can then be toggled on and off by pressing the [Pause/Break](#) key.

If you wish to use this function, ensure that the USB ports and any connected USB keyboard are not physically accessible, to prevent unauthorised activation of the touch feature.

Deactivating touch input control via the recessed button on the back of the Ekran GX

To deactivate touch input control on the Ekran GX:

1. Use a pointed object (e.g. a pen or paperclip) to press the recessed button on the back of the device once.
2. Touch input is now disabled.
 - No entries can be made via the touchscreen.
 - The display will turn off after the period set under Settings → Display & Language → Display Off Time.
 - Touching the screen will wake it up and display the last active page, but no interaction will be possible.

To re-enable touch input, press the recessed button again.

Deactivating touch input control using a momentary push button

On GX devices with digital inputs, you can configure one of the inputs to control touch functionality using an external momentary push-button.

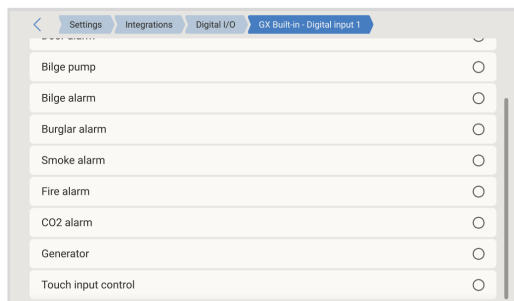

Configuration steps

1. Navigate to Settings → Integrations → Digital I/O → GX Built-in - Digital input [number of the digital input]
2. Enable Touch Input Control

Operation

- First press: Touch input is disabled.
 - No touch interactions are possible.
 - The display turns off after the configured timeout under Settings → General → Display & Appearance → Display Off Time.
 - Touching the screen will wake the display, but touch input remains disabled.
- Second press: Touch input is enabled again.

Important: Pressing the button pulls the GPIO pin to ground. Do not apply voltage to any GPIO pins.

Deactivating touch input control using an external USB keyboard

To control touch input via an external keyboard:

1. Connect a USB keyboard to one of the USB ports on the GX device.

2. Press the Pause/Break key to toggle touch input on or off.

For keyboards without Pause/Break key use one of the substitute key combinations mentioned [in this Wikipedia article](#).

3.6. Relay connections

The Ekran GX has potential-free Normally Open (NO) and Normally Closed (NC) relay functionality. The relay function can be configured via the GX device menu: Settings → Integrations → Relays → Function.

Relay 1 is particularly important, as it can be used not only for manual or [temperature \[100\]](#)-based triggering (as with Relay 2), but also as an [alarm \[87\]](#), [generator start/stop \[165\]](#), [Connected genset helper relay \[181\]](#), or [tank pump \[87\]](#) relay.

The relays can also be controlled via the [The Switch pane \[15\]](#).



By default, the relay is set to Normally Open (NO). The polarity can be reversed to Normally Closed (NC). Note: Reversing the polarity to Normally Closed (NC) will result in a slightly higher current consumption of the GX device.

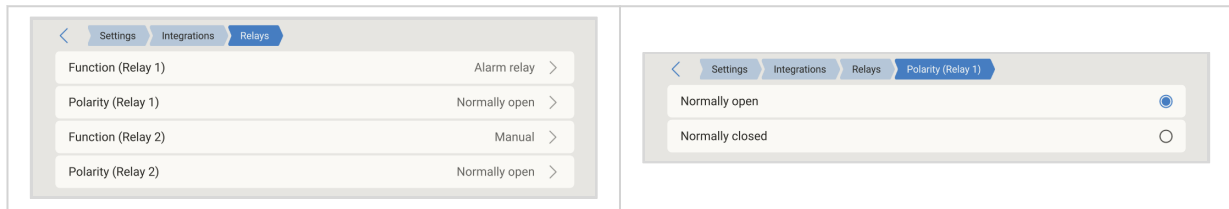

Be sure to observe voltage and current limits of the relays as specified in the [Technical specifications \[200\]](#).

4. The User Interface

4.1. User interface introduction

To follow this manual, ensure the "New UI" user interface is enabled on your GX device: Settings → General → Display & Appearance → User interface.

The user interface offers a clean and intuitive layout that simplifies navigation and improves data visibility.

Features

- **Remote Console:** Remote Console: Runs locally in your browser (via LAN or VRM) and communicates directly with the GX device.
- **Light and dark modes:** Optimised for varying light conditions. Dark mode is enabled by default.



4.2. The Brief Page

The Brief page provides a clear overview of key system data via a customisable ring-style widget.

- The configurable circular bars on the left show grid import/export power, solar generation, and, if available, alternator output from supported devices such as the Wakespeed WS500 or Orion XS.
- The centre widget, consisting of rings and a core display, shows the energy storage status and, if configured, tank level and/or temperature information.
- The circular bars on the right provide an overview of power consumption.

Configuration options are available in Settings → General → Display & Appearance → Brief page:

- Level 1..4: Set each level to display battery SoC or any available fluid type.
- Tank details: Choose between No labels, Show tank volumes, or Show percentage.
- Centre display: Adjust shown data under Center details.

To adjust data units for temperature, volume, or electrical power, go to Settings → General → Display & Appearance → Data units. For details, refer to the next section.

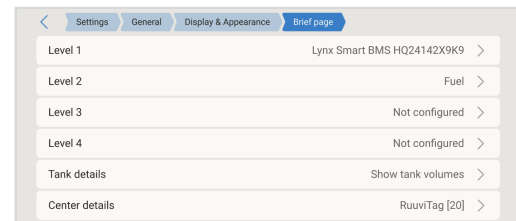
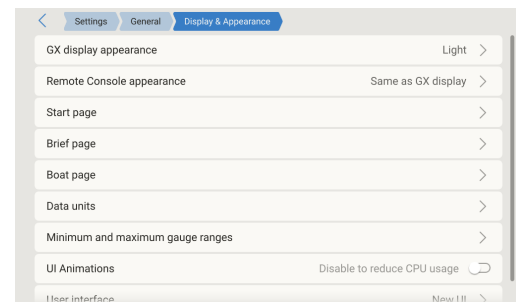
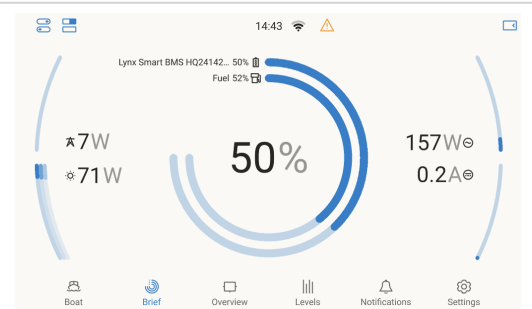

4.3. The Overview Page

The layout provides a comprehensive view of your system in a single location, enabling easy monitoring, control and management.

The Overview Page is divided into three sections:

- Left: Widgets for energy sources such as Grid, Solar Chargers, DC Genset, Alternators, and Wind power
- Centre: Energy storage and conversion
- Right: Load overview including AC Loads, EVCS, Essential Loads, and DC Loads

A button at the top left (accessible from any page) opens the control panel, providing quick access to:

- ESS controls
- Generator start/stop controls
- Inverter/charger controls
- Charger controls
- Inverter controls
- EV Charging Station controls

All items with a blue outline are tappable and open a detailed view.

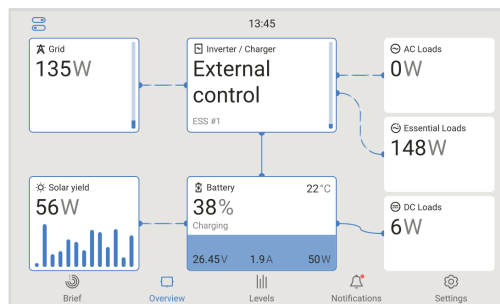

4.4. The Settings menu

The Settings menu is organised into high-level categories for easier navigation.

Breadcrumbs are displayed at the top of the screen, showing the current location within the menu. With a single tap, you can return to any level in the menu structure.

- To move back to a previous level, tap the relevant breadcrumb.
- To return to the main menu, tap the first breadcrumb in the list.

For example, if the path shown is Settings > General > Date & Time, tapping General will return to the General menu, while tapping Settings will return to the main Settings menu.

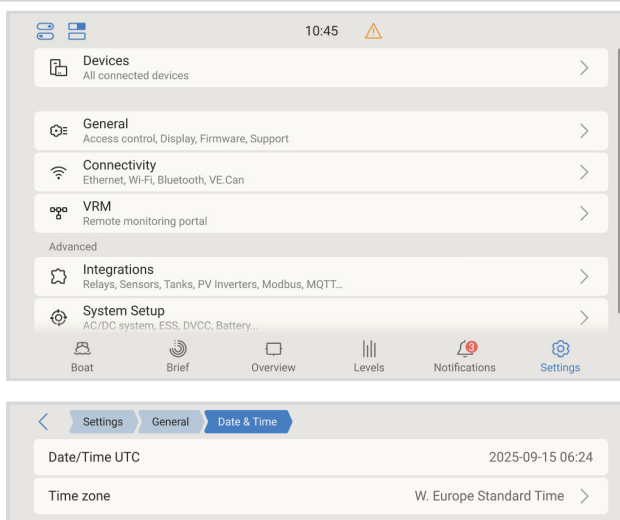

4.5. Data units

The Data units submenu allows configuration of the units and display formats used throughout the GX device interface.

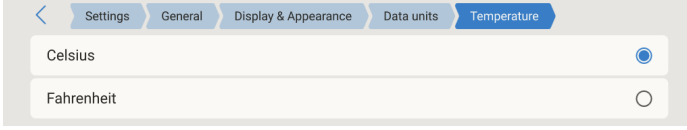
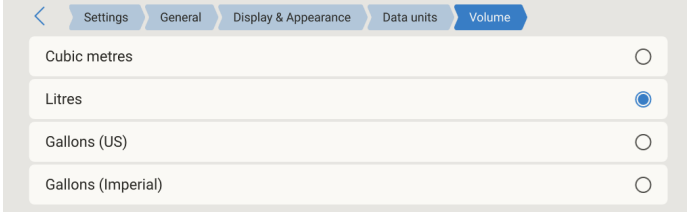
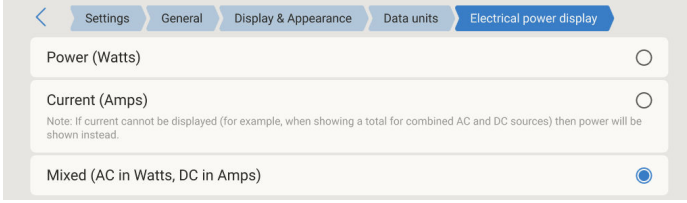
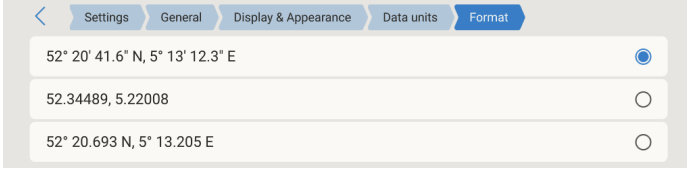
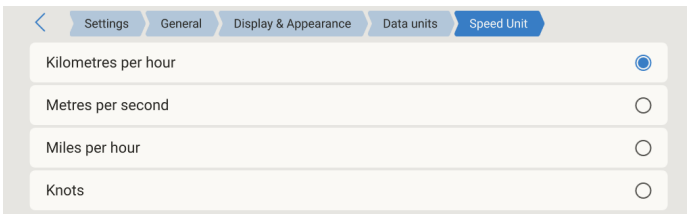
<p>Temperature: Select the unit used for temperature values:</p> <ul style="list-style-type: none"> • Celsius • Fahrenheit 	
<p>Volume: Select the unit used for volume measurements:</p> <ul style="list-style-type: none"> • Cubic metres • Litres • Gallons (US) • Gallons (Imperial) 	
<p>Electrical power display: Select how electrical values are displayed:</p> <ul style="list-style-type: none"> • Power (Watts) • Current (Amps) • Mixed (AC in Watts, DC in Amps) 	
<p>Format: Select the coordinate format used for GPS data:</p> <ul style="list-style-type: none"> • Degrees, minutes and seconds (e.g. 52° 20' 41.6" N, 5° 13' 12.3" E) • Decimal degrees (e.g. 52.34489, 5.22008) • Degrees and decimal minutes (e.g. 52° 20.693 N, 5° 13.205 E) 	
<p>Speed unit: Select the unit used for speed values:</p> <ul style="list-style-type: none"> • Kilometres per hour • Metres per second • Miles per hour • Knots 	

4.6. The Switch pane

The Switch pane is a quick-access control panel, available via touchscreen, Remote Console, Marine MFD HTML5 App, or VRM, for managing switching functions in vehicles, boats, or stationary systems.

When using the Marine MFD HTML5 app, the Switch pane is available on the MFD display. This allows control of GX onboard relays, supported Shelly devices and Node-RED virtual switches.

Supported devices

- [GX IO-Extender 150](#)
- [SmartSwitch DC4 from Energy Solutions](#)
- GX internal relays: [Relay connections \[10\]](#)
- [Garmin EmpirBus](#)
- [Safery](#) STAR-Power, STAR-Light, and STAR-Rover digital switching controllers

A button in the top-left corner of the UI opens this pane, providing control over digital outputs, relays, and other systems on supported devices.

This button is only visible when a supported device is connected.

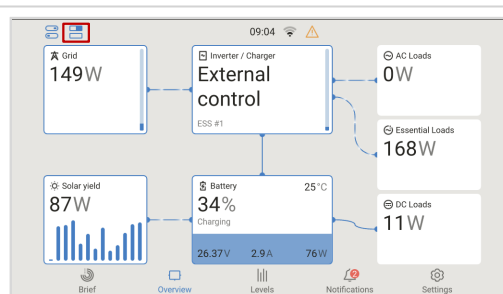

The layout of the Switch pane is determined by the configuration set in the Setup menu of each connected device. Outputs can be grouped to simplify the interface, especially useful when managing multiple outputs.

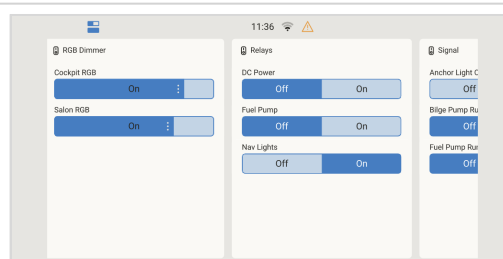

Supported devices for the Switch pane are configured through the device's Setup menu. The following options are available:

- **Name:** Define a custom name for the output.
- **Group:** Assign the output to a group. Outputs in the same group are displayed in a shared tile on the Switch pane.
- **Output type:** Select the desired output type (see section below).
- **Show controls:** When disabled, the output will not be shown on the Switch pane.

Available options:

- **Off** - Do not show the controls anywhere.
- **Always** - Show the controls in the Switch pane.

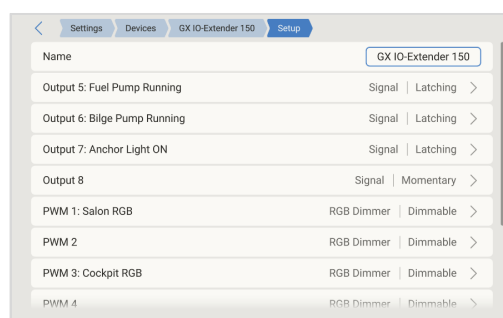

Supported control elements:

Most of the control elements listed below are only available when using the Virtual Switch (Node-RED) integration. Hardware-based switching devices typically provide only the first three basic output controls.

- **Momentary:** Output is active only while pressed.
- **Toggle:** Output switches state with each press.

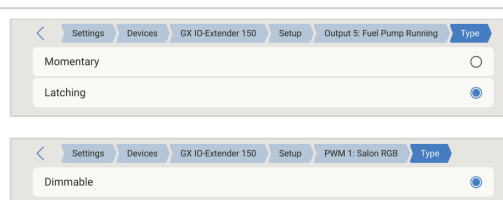

- Dimmable: Allows variable output control (for example lighting or fan speed).
- Temperature slider: Allows setting a target temperature.
- Basic slider: Generic slider control for adjustable values.
- Stepped switch: Provides on/off control with selectable modes (for example fan on/off with three speed levels).
- Dropdown: Allows selecting one option from a list (for example selecting a mode that affects a Node-RED flow).
- Numeric input: Allows entering a specific numeric value.
- Three-state switch: On/Off/Auto.
- Bilge pump control: Allows switching between Auto and On (manual override).
- Colour selector: Allows selecting colours and brightness for RGB lighting.

4.7. The Boat Page

The Boat page is designed for electric and hybrid boats, combining battery status, engine RPM, GPS data and electric drive information on a single display.

Data can be received via NMEA 2000 or CANopen (VE.Can) for compatible electric propulsion systems, from a Victron SmartShunt configured as a DC Energy Meter – Electric Drive, or via custom Node-RED integration. Multihull vessels and dual-engine setups are supported, including configurable port and starboard electric drives.

The Boat page appears in the menu alongside the Brief and Overview pages, and can also be accessed remotely via VRM or on a GX display.

For a short introduction to the Boat page and its features, see the video below:



4.7.1. Compatible systems

NMEA 2000 compatible systems

- FischerPanda - Communication Interface Electric Drive - NMEA 2000®
- Vetus - Vetus CANverter
- Combi - CAN Converter NMEA
- WaterWorld - WaterWorld NMEA-Connect

CANopen compatible systems and controllers

Compatible E-drive systems:

- Oceanvolt
- Kräutler
- Törkmar

Compatible plug-and play motor controllers:

- Sevcon Gen4 AC
- Curtis F series
- Curtis 123X E/ES series

4.7.2. How to integrate

The Boat page can combine data from different sources, such as GPS and electric propulsion systems. Integration is possible through Victron devices, NMEA 2000 networks, CANopen, or custom solutions. The following options show how to connect GPS and propulsion data to the GX device.

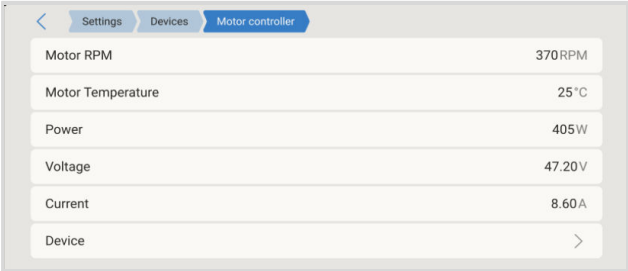
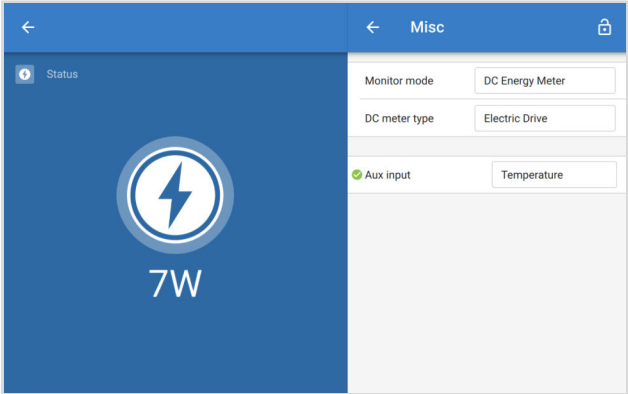
<p>GPS</p> <ul style="list-style-type: none"> • GPS mouse via USB - see Connecting a USB GPS [37] • GPS via NMEA 2000 - see Connecting a NMEA 2000 GPS [38] • Victron Energy GX GSM or LTE 4G with GPS antenna - see GX LTE 4G [78] • Custom Node-RED integration <p>Electric Propulsion</p> <ul style="list-style-type: none"> • Victron Energy SmartShunt, configured to DC Energy Meter → Electric Drive - see DC load monitor mode [28] • NMEA 2000-enabled propulsion system PGN's 128002, 127490 and 127494 • CANopen integration • Custom Node-RED integration 	 
---	---

4.7.3. Integration examples

Example 1: SmartShunt

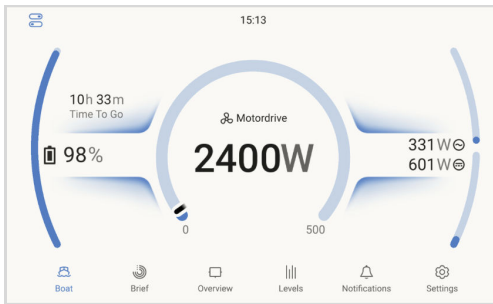
<p>For boats with only a SmartShunt measuring an electric drive, the Boat page shows:</p> <ul style="list-style-type: none"> • Propulsion power • Time-to-go • AC/DC load consumption • Battery SoC% 	
--	--

Example 2: SmartShunt plus GPS

<p>Same as Example 1, plus GPS. The Boat page shows:</p> <ul style="list-style-type: none"> • Propulsion power • Time-to-go • Battery SoC% • Boat speed 	
---	--

Example 3: NMEA2000-integrated propulsion engine

For propulsion integrated via NMEA 2000, the Boat page shows:

- Battery SoC%
- Time-to-go
- AC/DC load consumption
- Propulsion power consumption
- Forward/Neutral/Reverse (F/N/R) direction indication
- Engine RPM

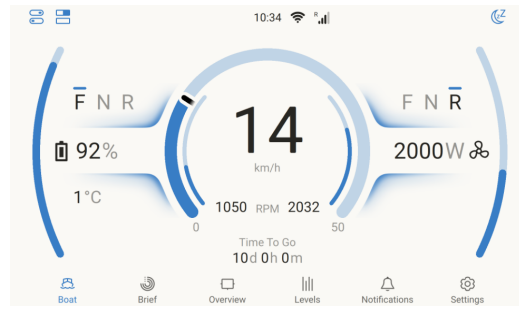

Example 4: NMEA2000-integrated propulsion engine with GPS

Same as Example 3, plus GPS. The Boat page shows:

- Battery SoC%
- Time-to-go
- AC/DC load consumption
- Propulsion power consumption
- Forward/Neutral/Reverse (F/N/R) direction indication
- Engine RPM
- Boat speed



4.7.4. Configuration & GX device monitoring

The Boat page can be customised to suit your preferences. Select the data units that best match your application, while gauge scaling for power, speed, and RPM is set automatically or can be adjusted manually if required.

<p>To enable the Boat page, go to</p> <ul style="list-style-type: none"> • Settings → General → Display & Appearance → Boat page and activate it. 	
--	--

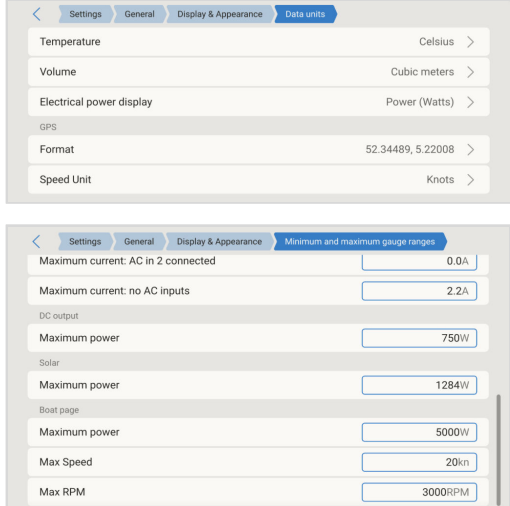
<p>Configure your preferred data units via</p> <ul style="list-style-type: none"> • Settings → General → Display & Appearance → Data units: <ul style="list-style-type: none"> • Power, current or mixed (AC in Watts and DC in Amps) • Speed in km/h, mph or knots <p>The minimum and maximum values for the power, speed and RPM gauges can be configured via</p> <ul style="list-style-type: none"> • Settings → General → Display & Appearance → Minimum and maximum gauge ranges. 	
---	--

GX device monitoring

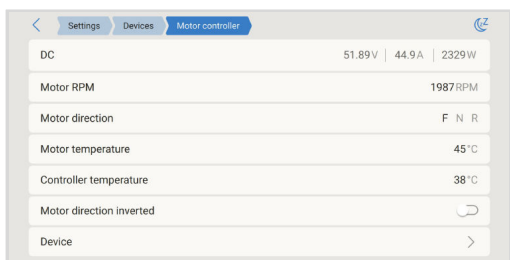
<p>A connected E-drive or motor controller appears in the Devices list and provides information such as:</p> <ul style="list-style-type: none"> • DC parameters (voltage, current and power) • Motor RPM • Motor direction • Motor temperature • Controller temperature • Option to adjust for inverted motor direction <p>This option inverts the displayed motor direction on the Boat page. It is intended for cases where the physical motor installation results in reversed direction reporting. Enabling this option only affects the visual representation in the user interface and does not change the actual motor rotation or controller configuration.</p> <ul style="list-style-type: none"> • Device submenu 	
--	--

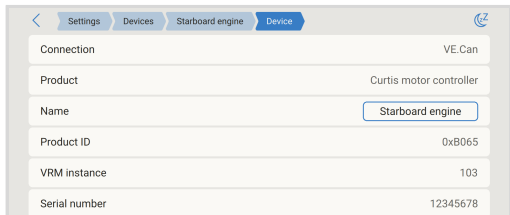
<p>The Device menu provides additional information for the connected E-Drive or motor controller and allows a custom name to be set for clear identification.</p>	
---	--

4.7.5. CANopen integration for electric propulsion systems

Venus OS supports the CANopen profile for integration with electric propulsion systems and Sevcon and Curtis motor controllers, enabling monitoring on the GX Boat page and in VRM.

- Motor and RPM data is updated eight times per second for smooth gauge animation
- The GX device displays notifications and error messages received from compatible CANopen systems and controllers.

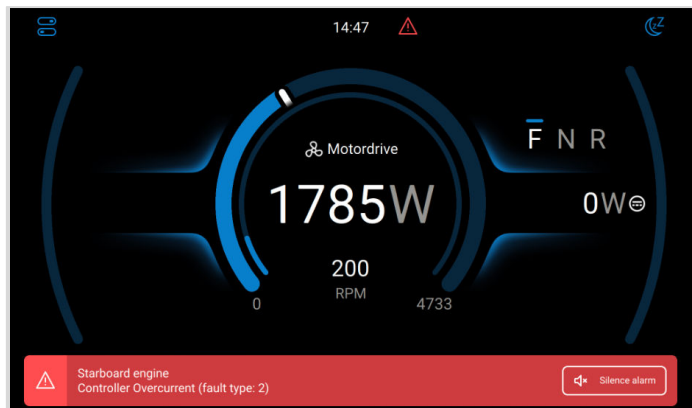

4.7.6. Multihull / dual engine setup support

Venus OS supports multihull / dual engine setups.

For dual electric drive systems, the following parameters are supported:

- Configurable left & right E-drives
- RPM and drive direction are shown separately per drive
- Drive direction per motor
- Aggregated propulsion power of both E-drives
- The Boat Page indicates when one or more drives are regenerating power

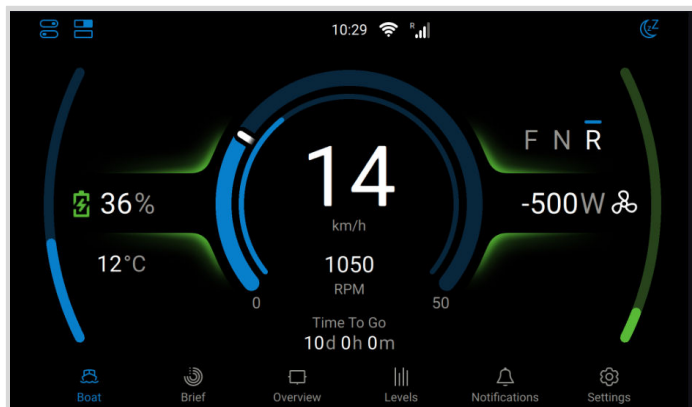

When dual engines are connected, the Boat page configuration (Settings → General → Display & Appearance → Boat page) provides additional options and allows the E-drive to be assigned to the left and right side respectively.

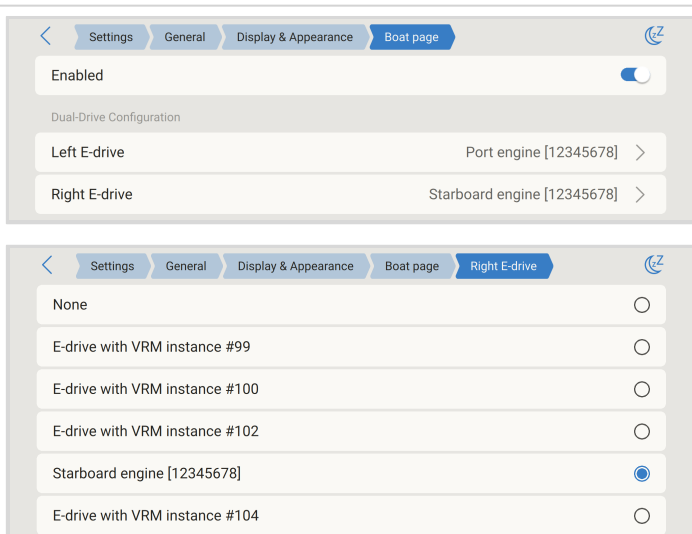

4.7.7. VRM Monitoring

The data relevant to the electric propulsion system is made available on VRM, including detailed data in the Advanced section of VRM.

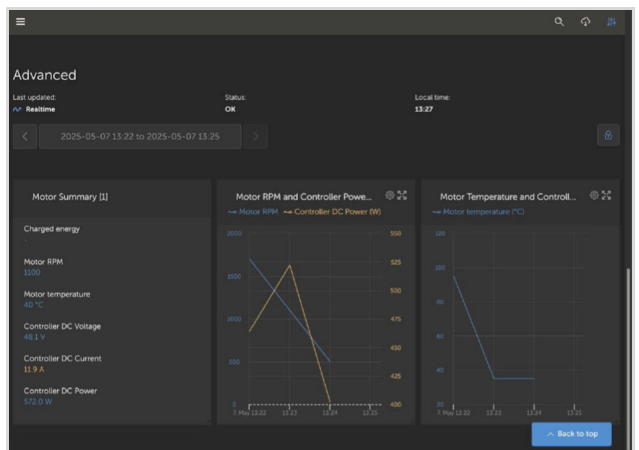

4.8. The Support status (modification checks) page

The Modification checks page is available under Settings → General. It provides a clear indication of whether the GX device is running in its standard configuration or has been modified.

This page helps users, installers, and distributors recognise system modifications quickly and, if required, restore the device to its standard configuration. This reduces time spent on support and troubleshooting.

To check the support status:

1. Go to Settings → General → Support status (modifications checks).
2. Review the displayed status:
 - Standard – items shown in green, meaning unmodified.
 - Modified – items shown in orange, meaning the item has been changed from its standard configuration.

Note: Items shown in orange are supported and provided by Victron Energy. However, incorrect use can affect system stability. During troubleshooting, disable these items first.

The GX device also monitors the free space in the data partition and raises an alarm when the available space drops below 10%.



A full data partition is only a concern on GX devices running the [Venus OS Large image \[104\]](#) image, or on systems that have been modified for advanced usage.

To increase free space, follow the instructions in the [Victron Node-RED/Signal K documentation](#).

Category	Item	Status
Support status	Support status	Check below items in orange
Device model	Device model	Ekran GX
HQ serial number	HQ serial number	HQ23364TDTK
Data partition free space	Data partition free space	1.0 GB
User SSH key present	User SSH key present	No
Modifications	Custom startup scripts	Not installed
File system (rootfs) status	File system (rootfs) status	Clean
Firmware	Installed firmware version	v3.70~34
Installed image type	Installed image type	Large
Latest official firmware version installed?	Latest official firmware version installed?	No, v3.65 is available
Update the firmware to fix the modified state	Update the firmware to fix the modified state	Press to update to v3.65
Integrations	Modbus TCP Server	Enabled
Signal K	Signal K	Disabled
Node-RED	Node-RED	Disabled

Items colored orange are supported and provided by Victron Energy, but using them incorrectly can affect system stability. In case of troubleshooting, disable those first.

4.9. Network security profile

The Network security profile setting allows you to control how data is exchanged locally (via Ethernet or WiFi) and remotely (via VRM).

You can choose from three profiles:

Network Security Profile*	Remote Console		Data transmission to VRM
	Locally via Ethernet or WiFi	Via VRM	
Secured	https only** password protected***	Access depends on user access level for that installation in VRM:	Over https only
Weak	http and https password protected	<u>Admin</u> and <u>Technician</u> can access without asking for a password.	Over https or http by user option
Unsecured	http and https not password protected	<u>User</u> has no access.	

- * When upgrading from a version prior to v3.50, the profile is automatically set to match the previously configured network and Remote Console settings. New devices shipped with v3.50 or later default to Secured.
- ** Any access on http will be redirected to the https equivalent.
- *** On new units shipped with v3.50 or later, the default device password is the same six-digit random PIN used for Bluetooth, printed on the enclosure on the GX device. When upgrading an existing GX device, the security profile is automatically configured to match the current user-defined settings, such as whether Remote Console over LAN is enabled and password protected.

Changes to the security profile can be made under Settings → General → Access & Security → Local network security profile in the Settings menu.



Network security profile details

- The Network security profile setting applies exclusively to local network access. It does not affect physical device access or the on-screen access level setting (User / User & Installer), which are configured separately.
- When accessing the Remote Console over LAN via HTTPS, your browser will display a certificate warning. This must be accepted to proceed.
- Once logged in to the Remote Console over LAN or WiFi, the browser session remains active for 365 days before requiring a new login.

Recovering a lost network access password

If the network access password is lost, it can be reset using one of the following methods, depending on the GX device model:

- The network access password can be changed directly via the device display. This requires the access level to be set to User & Installer.
- Insert a USB stick configured as a "Reset to factory defaults" stick and reboot the device. Refer to [Reset to factory defaults procedure \[191\]](#) for instructions on creating the USB stick.

Notes:

- The device password can be changed and must be at least 8 characters long.
- The Bluetooth PIN remains fixed at six digits, as per Bluetooth standards.

5. Connecting Victron products

5.1. VE.Bus Multis/Quattros/Inverters

For brevity, all Multis, Quattros, and Inverters are referred to as *VE.Bus* products.

Compatibility with GX devices

The earliest VE.Bus firmware supported by the EGX is 111.

The table below outlines compatibility based on the VE.Bus device's microprocessor version:

VE.Bus device microprocessor	GX device support
18xxxxxx	No
19xx111	Yes
20xx111	Yes
26xxxxxx	Yes
27xxxxxx	Yes
Notes:	
<ul style="list-style-type: none"> The first two digits indicate the microprocessor version. The last three digits indicate the VE.Bus firmware version. 	

Remote on/off terminal use

For Multis, Quattros and EasySolars:

- It is not possible to use the Remote On/Off header with a GX device.
- Keep the factory connection: wire between left and middle terminal.
- If system disable is required, use the [Safety Switch Assistant](#).

Note: The above limitation does not apply to: MultiPlus-II, Quattro-II, and EasySolar-II. They support Remote On/Off together with GX devices.

System connections



Do not confuse the VE.Bus ports on a GX device with the Ethernet or VE.Can/BMS-Can ports.

Single VE.Bus products

- Connect to either VE.Bus port on the GX device.
- Use standard RJ45 UTP cable (see [pricelist](#)).



Leave any unused VE.Bus ports open. Do not insert the blue RJ45 VE.Can terminators into these ports.

Parallel, split- and three-phase VE.Bus systems

- To connect multiple VE.Bus products, configured as a parallel, split-phase or three-phase VE.Bus system, connect the first or last VE.Bus product in the chain to a GX device VE.Bus port.
- Use standard RJ45 UTP cable (see [pricelist](#)).



Leave any unused VE.Bus ports open. Do not insert the blue RJ45 VE.Can terminators into these ports.

VE.Bus systems with Lithium batteries and VE.Bus BMS (v1 only)

The following applies only to the VE.Bus BMS V1, not to be confused with its successors, the VE.Bus BMS V2 or VE.Bus BMS NG.

GX device connection

- Connect the GX device to the MultiPlus/Quattro VE.Bus socket, not to the Remote panel socket.
- Alternatively, connect to one of the Multis/Quattros in the system.
- Combining MultiPlus/Quattro with a VE.Bus BMS and a Digital Multi Control is possible. Simply connect the Digital Multi Control to the RJ45 socket on the VE.Bus BMS labelled *Remote panel*.

Limitations

- The On/Off/Charger Only control will be disabled automatically in the GX device menu when a VE.Bus BMS is detected.
- Combining a MultiPlus/Quattro with a VE.Bus BMS and a Digital Multi Control is possible. Simply connect the Digital Multi Control to the RJ45 socket on the VE.Bus BMS labelled *Remote panel*.
- Input current limit settings remain available via the GX device, even with a VE.Bus BMS.

Auto power-down on low battery

- To enable auto power-down in the GX device on low battery:
 - Connect the Power in V+ terminal on the GX device to the Load Disconnect output of the VE.Bus BMS.
 - Ensure both the GX device and the VE.Bus BMS share the same battery negative (GND).

Combining the EGX with a Digital Multi Control

Both a GX device and a Digital Multi Control (DMC) can be connected to the same VE.Bus system. However, please note:

- The On/Off and Charger Only controls on the GX device are disabled when a DMC is present.
- The input current limit is set via the Digital Multi Control. This setting takes precedence and overrides the GX device. It cannot be adjusted from the GX device in this configuration.

Connecting multiple VE.Bus systems to a single EGX

Only one VE.Bus system can be connected directly to the GX device's built-in VE.Bus ports. To connect additional systems, consider the following options:

Option 1: Use an MK3-USB interface

This method allows multiple systems to be visible, but with limited functionality:

- Only the system connected to the built-in VE.Bus ports contributes data to the Overview pages.
- All connected systems appear in the Device List and are included in VRM energy statistics.
- DVCC and ESS control applies only to the system connected directly to the built-in VE.Bus ports.
- Additional Systems connected via MK3-USB do not support DVCC control and will follow their own internal configuration for charging/discharging.
- There is an option (Settings → System Setup → Charge Control) to enable BMS control of a secondary inverter/charger connected to a GX device via an MK3-USB interface. When enabled, the secondary device will follow the CVL and DCL values provided by the CAN-connected BMS.
- Generator start/stop logic applies only to the directly connected system.
- For ESS systems, only the system on the built-in VE.Bus ports participates in ESS mechanisms. Others are visible in the Device List only.

Option 2: Use VE.Bus to VE.Can Interface (ASS030520105)

- **Not recommended** - this is a deprecated product.
- Requires one interface per VE.Bus system.
- VE.Can must be properly terminated and powered. For more details, refer to the [data communication whitepaper](#), Q17.

Additional features provided by a GX device to VE.Bus products

When connected to the internet, the GX device enables the following:

- Remote configuration via VRM – see [Remote VE.Configure manual](#) for more information, system requirements and specific steps to access this feature.
- Remote VE.Bus firmware updates – see [Remote VE.Bus Firmware Updates Manual](#).

5.2. AC load monitoring

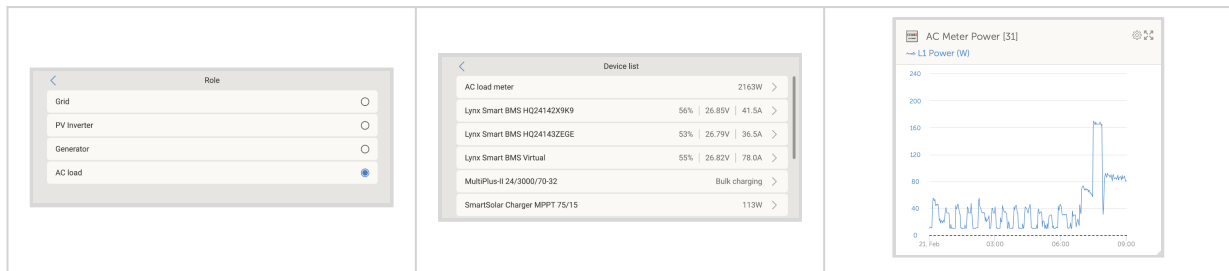

All supported [energy meter types](#) can be assigned the role of AC meter.

To do this, go to: Settings → →Integrations Energy meters via RS485 → [your_energy_meter] → Role and select AC meter as the role (alternatives include Grid, PV Inverter, and Generator).



Please note that such metered loads are not used in any calculations, just monitoring.

5.3. Battery monitors, MPPTs, Orion XS and Smart IP43 Chargers with a VE.Direct port

Devices with a VE.Direct port, such as BMV battery monitors, MPPT solar chargers, Orion XS, and Smart IP43 Chargers, can be directly connected to a GX device via VE.Direct.

There are two VE.Direct cable types available:

1. Straight VE.Direct cables - Part no. ASS030530xxx
2. Right-angle VE.Direct cables - Part no. ASS030531xxx, designed to minimise depth behind mounting panels



VE.Direct cables have a maximum length of 10 m and cannot be extended. For longer distances, use a [VE.Direct to USB interface](#) with an active USB extension cable.

VE.Direct to VE.Can interface (limited use)

The VE.Direct to VE.Can interface can be used only with:

- BMV-700
- BMV-702

⚠ Not compatible with:

- BMV-712
- MPPT solar chargers
- VE.Direct inverters

This interface does not convert data for those devices into CAN-bus messages.

If using the VE.Direct to VE.Can interface:

- Ensure the VE.Can network is terminated and powered.
- Refer to Q17 in the [Victron Data Communication Whitepaper](#) for powering instructions.



This interface is deprecated and not recommended for new installations.

Connecting more VE.Direct devices to your Ekran GX than physical VE.Direct Ports

If you need to connect more VE.Direct devices than there are VE.Direct ports, the following options are available:

- Use the [VE.Direct to USB interface](#).
- Use a USB hub if more ports are required.

Please refer to the [Overview of connections \[4\]](#) section for details on the maximum number of VE.Direct devices that can be connected.

Notes on older VE.Direct MPPTs

Some older models, like the MPPT 70/15, are not compatible with GX devices unless they meet a minimum hardware revision:

- The device must be from year/week 1308 or later.
- Firmware updates will not resolve incompatibility with earlier models.

To identify your model:

- Check the serial number printed on the rear label.
- Example: HQ1309DER4F means 2013, week 09, which is compatible.

5.3.1. DC load monitor mode

You can use a SmartShunt or BMV-712 to monitor individual DC circuits rather than the entire battery system. To do this, change the Monitor mode setting from Battery Monitor to DC Energy Meter using VictronConnect.

Available DC meter types

Once DC Energy Meter mode is selected, the following types can be assigned in VictronConnect:

- Sources: Solar charger, Wind charger, Shaft generator, Alternator, Fuel cell, Water generator, DC-DC charger, AC charger, Generic source
- Loads: Generic load, Electric drive, Fridge, Water pump, Bilge pump, DC system, Inverter, Water heater

Integration with GX devices

When connected to the Ekran GX, the selected meter type along with current (A) and power (W) is displayed in the user interface and sent to the VRM Portal for remote monitoring.

Special case: Type "DC System"

When configured as type "DC System", the EGX offers extended functionality beyond data logging:

1. The DC System power display aggregates readings from all SmartShunts configured with the DC System type. This supports multi-location systems, for example, DC systems in both hulls of a catamaran.
2. DVCC Charge Current Limiting is dynamically adjusted: The GX device compensates for DC loads when setting charge current limits for Multis, Quattros, and Solar Chargers. For example:
 - If a DC load of 50 A is being measured
 - And the battery reports a CCL (Charge Current Limit) of 25 A
 - Then the system sets a limit of 75 A to the charging sources → Resulting in optimised charging behaviour for Yachts, RVs, Coaches, and other systems with significant DC loads.

Notes and limitations:

- This feature is supported only by SmartShunt and BMV-712. It is not available on BMV-700 or BMV-702.
- The Monitor mode must be configured using VictronConnect directly on the SmartShunt or BMV-712. For setup instructions, refer to the BMV-712 or SmartShunt product manual on the [Battery Monitor product page](#)
- The NMEA2000-out feature does not support the DC meter types. For example, if a SmartShunt is configured to monitor an alternator, that data will not be available via NMEA 2000.

5.4. VE.Can Devices

To connect a product with a VE.Can port, use a standard [RJ45 UTP cable](#) (available with straight and elbow connectors).

Important:

Terminate the VE.Can network at both ends using [VE.Can terminator](#). A bag with two terminators is included with each VE.Can product. Additional terminators are [available separately](#).

Compatibility notes

- The MPPT 150/70 must be running firmware v2.00 or newer to function with GX devices
- A Skylla-i control panel and an Ion Control panel can be used together with GX devices
- All VE.Can devices provide power to the VE.Can network, so no separate VE.Can power supply is required
- Protocol converters (e.g. VE.Bus to VE.Can interface, BMV to VE.Can interface) do not power the VE.Can network

VictronConnect-Remote (VC-R) support

The following VE.Can products support VictronConnect-Remote (VC-R), enabling configuration and monitoring via VRM. For more details, refer to the [VictronConnect manual](#).

VE.Can product	VC-R	Remarks
Lynx Shunt VE.Can	Yes	-
Lynx Smart BMS, Lynx BMS NG	Yes	-
Inverter RS, Multi RS and MPPT RS	Yes	They also have VE.Direct but must be connected via VE.Can for VC-R
Blue/Smart Solar VE.Can MPPTs ^[1]	Yes	Tr and MC4 models
Skylla-i and Skylla-IP44/-IP65	Yes	Requires firmware v1.11
^[1] All VE.Can solar chargers except the very old (big rectangular case with display) BlueSolar MPPT VE.Can 150/70 and 150/85		

5.5. VE.Can Interfaces

The Ekran GX has two fully functional VE.Can ports. They are **independent** from a data and connected device perspective. One is labelled VE.Can 1 and is galvanically isolated, the other is labelled VE.Can 2 and is non-isolated.

- 2 × Fully configurable VE.Can ports (VE.Can 1 is isolated)
- Both ports can be set to:
 - VE.Can (250 kbit/s, default)
 - BMS-Can (500 kbit/s)
 - CAN-bus BMS (250 kbit/s)
 - Other supported CAN profiles such as RV-C

Usage guideline

- VE.Can (250 kbit/s, default)
 - For Victron devices like:
 - VE.Can MPPTs
 - Skylla-IP65
 - Lynx Shunt VE.Can
 - Lynx Smart BMS and Lynx Smart BMS NG
 - Terminate both ends using the included VE.Can terminators
- BMS-Can (500 kbit/s)
 - For managed lithium batteries (e.g. BYD, Pylontech, Freedomwon)
 - Terminate at the Cerbo GX with the included terminator
 - Follow the battery manufacturer's instructions for termination on the battery side

Important

- VE.Can and BMS-Can must not share the same bus
- If both are needed, use a GX device with two separate CAN buses (e.g. Cerbo GX MK2 or Ekran GX)

Port configuration

- Access via Remote Console:
 - Settings → Connectivity → VE.Can port 1 / 2 → CAN-bus Profile
- Default settings:
 - VE.Can: 250 kbit/s

Notes

- Some BMS units use CANbus BMS profile at (250 kbit/s). Connect these to a VE.Can port and set the appropriate profile VE.Can & CAN-bus BMS (250 kbit/s).
- Only use batteries listed on Victron's [compatibility list](#) to ensure proper communication. Others are not supported.

5.6. Inverter RS, Multi RS and MPPT RS

The Inverter RS, Inverter RS Solar, and Multi RS are equipped with both VE.Direct and VE.Can interfaces. However, for these products:

- A GX device must be connected via VE.Can.
- VE.Direct cannot be used to connect these devices to a GX system.

The VE.Direct interface on these models is intended solely for programming, using a VE.Direct to USB adapter.

Exception: MPPT RS

The MPPT RS can be connected to a GX device via either VE.Direct or VE.Can, depending on system requirements and available ports.

5.7. BMV-600 series

- Connect the BMV-600 using the VE.Direct to BMV-60xS cable. (ASS0305322xx).

5.8. DC Link Box

- Connect the DC Link Box with the supplied RJ12 cable. Then connect the BMV-700 to the EGX.

5.9. VE.Can Resistive Tank Sender Adapter

See the [VE.Can resistive tank sender adapter](#) product page for details about the adapter.

Connection guidelines

- Use a [standard RJ45](#) UTP cable to connect the adapter to a VE.Can network.
- Terminate the VE.Can network at both ends using VE.Can terminators.
A bag with two terminators is included with each VE.Can product.
Additional terminators are available [separately](#) (Part No. ASS030700000).
- Ensure that the CAN-bus is powered.
Refer to the [Power chapter in the Tank Sender Adapter manual](#) for details.

5.10. Connecting a GX Tank 140

The GX Tank 140 is an accessory for the Victron GX range of system monitoring products. It supports up to four tank-level sensors, with readings visible locally on the GX device and remotely via the VRM Portal.

Input compatibility

The GX Tank 140 supports:

- Current senders (4–20 mA)
- Voltage senders (0–10 V)

Connection and power

- The device connects to the GX system via USB, which also powers the unit. No separate power supply is required for the GX Tank itself.
- To simplify installation, two of the four inputs provide an integrated 24 V supply for powering compatible senders.
- The remaining two channels require external power, which can be supplied via the power input terminal with fused outputs provided.

Configuration options

- Upper and lower limits are configurable, allowing compatibility with partial-scale sensors (e.g. 0–5 V).
- For marine applications, tank level data can be transmitted via NMEA 2000, enabling display on third-party equipment such as MFDs (Multifunction Displays).

For full technical details, refer to the documentation available on the [GX Tank 140 product page](#).

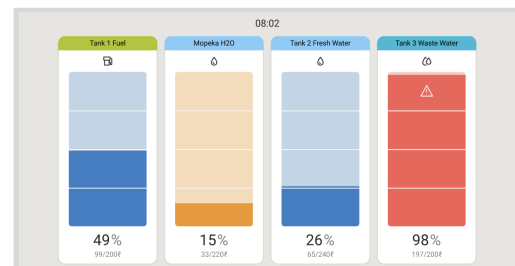

5.11. Connecting hardwired Victron temperature sensors

Victron temperature sensors can be used to measure and monitor various temperature sources, not limited to batteries. The supported measurement range is $-40\text{ }^{\circ}\text{C}$ to $+70\text{ }^{\circ}\text{C}$.

See the [Connection Overview \[4\]](#) for the location and number of temperature sensor inputs.

Compatible sensor

The correct sensor to use is: [ASS000001000 – Temperature Sensor for Quattro, MultiPlus, and GX Devices](#)

Note: This is not the same as the BMV temperature sensor accessory, which is not compatible with these inputs.

Additional notes

- Although the sensor resembles a battery lug, it does not need to be installed on a battery.
- Sensors are not included with the GX device and must be ordered separately.

Physical connection of temperature sensors

To connect the temperature sensors:

- The sensor wire must have either a ferrule or at least 10 mm of exposed copper to ensure proper contact inside the removable terminal block connector.
- Insert the wire fully into the terminal block.
- To release the wire, press down on the orange tab on the connector.

Wire polarity

- Red wire → Top terminal
- Black wire → Bottom terminal

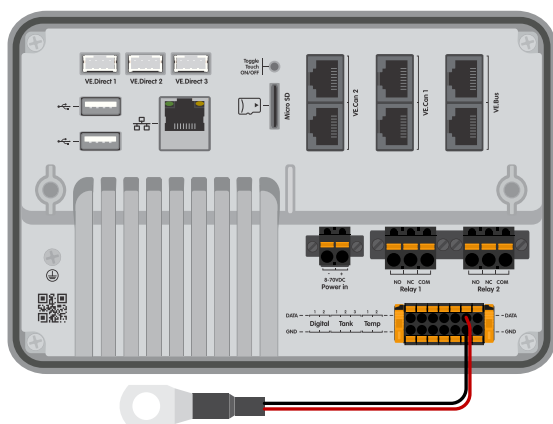

[ASS000001000](#) - Temperature sensor Quattro, MultiPlus and GX Device

Sensors are enabled (and disabled) in the Settings → Integrations → Tank and Temperature Sensors menu of the GX device.

Once enabled, temperature sensor data is visible in the device list, and also logged to VRM.

Note: The Ekrano GX and Venus GX have two temperature inputs, while the Cerbo GX has four.

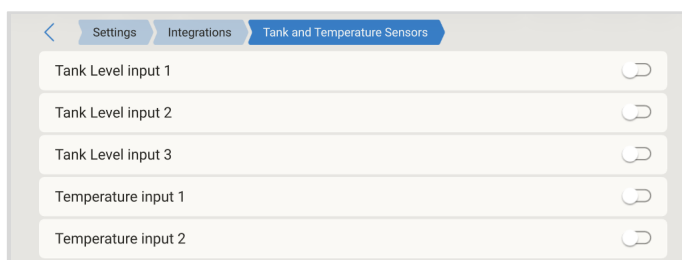

Selecting the temperature sensor from the device list menu displays an overview of the sensor's status and current temperature. The overview also includes two submenus: one for sensor setup and another for the device menu.

The temperature type can be changed in the Setup menu. The available options are Battery, Fridge, or Generic.

An offset can be applied to correct the reading, and the scale can be adjusted using a multiplier between 1 and 10. Additionally, the sensor voltage can be monitored.

The device menu provides general information about the sensor and allows you to assign a custom name for easier identification when multiple sensors are in use.

The image displays four sequential screenshots of the Ekran GX interface for configuring a Heatsink temperature sensor:

- Heatsink Status:** Shows the sensor's status as 'OK', a current temperature of 22.0°C, and options for 'Setup' and 'Device'.
- Type Selection:** Allows choosing the sensor type from 'Battery', 'Fridge', and 'Generic' (which is selected).
- Setup Configuration:** Shows the 'Type' set to 'Generic', an 'Offset' of 0, a 'Scale' of 1.0, and a 'Sensor voltage' of 2.95V.
- Device Information:** Displays details such as 'Connection' (Temperature input 1), 'Product' (Generic Temperature Input), 'Name' (Heatsink), 'Product ID' (0xA162), 'Firmware version' (–), and 'VRM instance' (23).

5.12. Victron Energy Meter VM-3P75CT

The Victron VM-3P75CT is a versatile energy meter for monitoring single-phase and three-phase power and energy consumption. It can be used to measure:

- Grid connection (at the distribution box)
- PV inverter output
- Generator (AC genset) output
- Inverter or inverter/charger output

The meter calculates power values for each phase and transmits the data at a high refresh rate over VE.Can or Ethernet.

Key features

- Dual communication options: VE.Can and Ethernet
- Compatible with GX devices such as the [Cerbo GX](#) and [Ekran GX](#)
- Data is viewable on the GX device, [VictronConnect](#), and the [VRM Portal](#)
- Split-core current transformers for easy, non-intrusive installation

Installation

- Follow the setup procedure as described in the VM-3P75CT energy meter manual.
- Ensure the energy meter is on the same local network as the GX device when using Ethernet.

VE.Can connection: Plug-and-play. No manual activation required.

Ethernet connection: After initial installation, the energy meter must be activated:

In the GX device menu, go to Settings → Integrations → Modbus Devices → Discovered devices and enable the discovered energy meter; it's disabled by default when first installed and powered.

The VM-3P75CT then becomes visible in the device list and can be monitored from there. For more details, see the [energy meter manual](#).

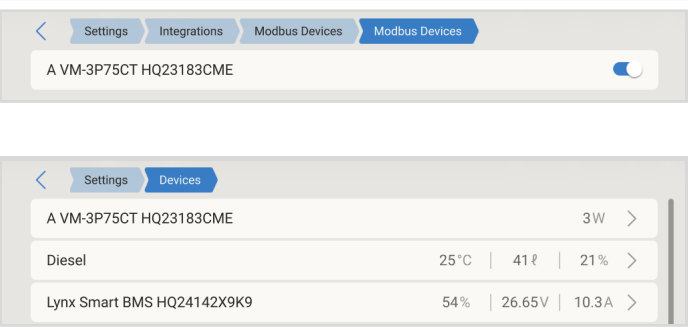

The screenshot shows the 'Modbus Devices' settings page with a toggle for 'A VM-3P75CT HQ23183CME' turned on. Below it, the 'Devices' list shows the same device with a power consumption of 3W, along with other devices like 'Diesel' and 'Lynx Smart BMS HQ24142X9K9' with their respective status indicators.

5.13. EV Charging Station

The [EV Charging Station](#) and [EV Charging Station NS](#), with both three-phase and single-phase charging capabilities, integrate seamlessly into the Victron environment via a [GX device](#) connection over WiFi. Operation and monitoring are easily managed via Bluetooth using the [VictronConnect App](#).

Set up and configure the EVCS according to the instructions in the [EV Charging Station manual](#). Ensure that:

1. Communication with the GX device is enabled.
2. The EVCS and GX device are connected to the same local network.

GX device setup

1. On the GX device, navigate to: Settings → Integrations → Modbus TCP Server, and enable Modbus TCP Server.
2. Then go to: Settings → Integrations → Modbus Devices → Discovered devices, and enable the detected EVCS.

Note: EV Charging Stations connected before updating the GX device to firmware version 3.12 will be activated automatically. New devices must be enabled manually via the above menu.

Once activated, the EVCS will appear in the device list, where it can be monitored and controlled. For further details, refer to the [EV Charging Station Manual](#).

Control of the EVCS is also available from the control pane by tapping the control pane button  in the top left corner of the user interface.

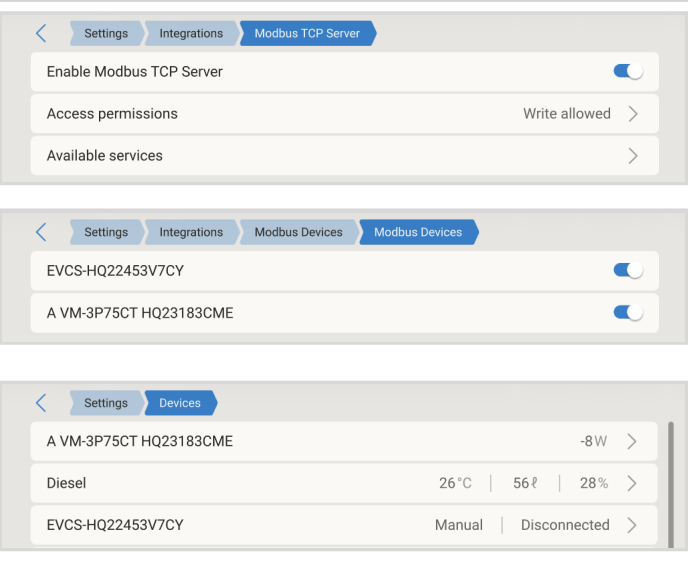

The screenshot shows the 'Modbus TCP Server' settings page with 'Enable Modbus TCP Server' turned on. Below it, the 'Modbus Devices' settings page shows 'EVCS-HQ22453V7CY' and 'A VM-3P75CT HQ23183CME' both with their toggles turned on. The 'Devices' list at the bottom shows the EVCS with a power consumption of -8W, along with the other devices.

5.14. GX IO-Extender 150

The GX IO-Extender 150 is a USB-connected expansion module that extends the available IO ports of GX devices such as the Ekrano GX and Cerbo GX.

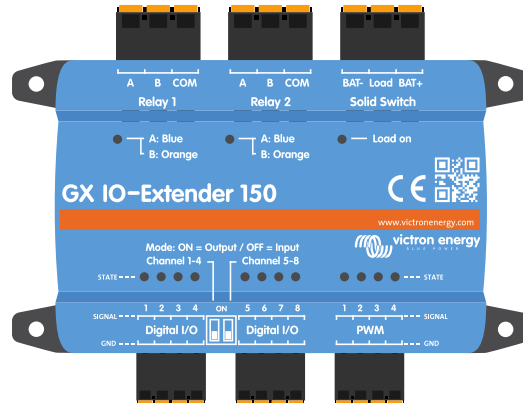

It bridges the gap between your GX device and the external world, creating endless possibilities for monitoring, control, and automation.

Features

- 8 digital IOs, configurable as in two sets of four as inputs or outputs (via DIP switch).
- 4 PWM ports, 0 to 5V with 0,05 V steps for device regulation.
- 2 latching relays that maintain their state even if the power is lost.
- 1 solid switch with bat-, load, and bat+ connections for switching requirements.

The plug-and-play USB connectivity makes installation effortless. The GX IO-Extender 150 is simply plugged into an available USB port on the GX device and the inputs/outputs, PWMs and relays immediately become available to the system.

Whether you're managing a complex off-grid solar installation, a marine electrical system, or an industrial backup power solution, the GX IO-Extender 150 expands your ability to deliver on specific requirements:

- Monitor additional sensors and equipment
- Control external devices with precision
- Automate complex system responses
- Implement sophisticated control logic

The GX IO-Extender is not intended to be used for general load switching, but rather for signalling. The relays and solid switch have low current ratings that vary based on the voltage being used. Compatible products like those from Energy Solutions (UK), Garmin (USA) and Safery, and others will be better suited for general switching applications.

Installation

For installation details and technical specifications, refer to the [GX IO-Extender 150 manual](#).

GX device configuration

Once connected and powered, the GX IO-Extender 150 will appear in the Devices list on the GX device.

The GX IO-Extender device's page displays:

- Module state
- Output state
- PWM percentage
- Output mode

A dedicated Setup menu allows configuration of each output individually.

On each individual output page in the Setup menu, the following options are available:

- Custom name – Assign a unique name to the output. (Note: the module name can be changed via the Device menu).
- Group: Allocate the output to a group.
- Type: Select the output mode: Latching (Toggle), Momentary, or Dimmable.
- Show controls: Enable or disable visibility of the output in the Switch pane.

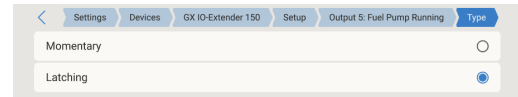
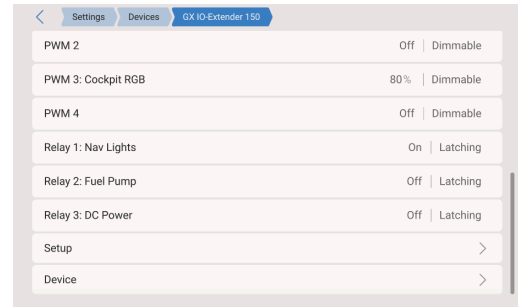

Grouping outputs

Each output can be grouped by assigning a group name on the channel's setup page.

Outputs with the same group name are displayed together in a single group card on the Switch pane. This makes it easy to combine related outputs, for example, grouping all lighting outputs under one tile.

Channels without a group name will appear in a card labelled with the module name.

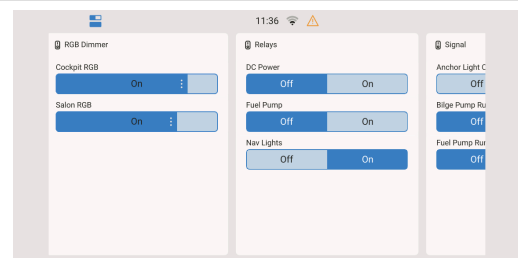

6. Connecting supported non-Victron products

6.1. Connecting a PV Inverter

Connecting a PV inverter to a GX device allows for real-time monitoring of power production and energy distribution. This provides users with insight into the actual power balance and energy flows within the system.

Note: These measurements are for monitoring purposes only and are not required for system operation or performance.

PV Inverter curtailment

In addition to monitoring, certain PV inverter models and brands can be curtailed by the GX device, meaning the output power can be actively reduced when needed.

This functionality is required for systems using the [ESS Zero Feed-in or Limited Feed-in feature](#).

Direct connections

Type	Zero feed-in	Details
Fronius	Yes	LAN Connection, see GX - GX - Fronius manual
SMA	No	LAN Connection, see GX - GX - SMA manual
SolarEdge	No	LAN Connection, see GX - SolarEdge manual
ABB	Yes	LAN Connection, see GX - ABB manual

Using a meter

For PV Inverters that cannot be interfaced digitally, a meter can be used:

Type	Zero feed-in	Details
AC Current Sensor	No	Connected to inverter/charger analog input. Lowest cost - least accurate. Energy Meter
Energy Meter	No	Wired to the EGX, or connected wirelessly using our Zigbee to USB/RS485 converters . See the Energy Meters start page
Wireless AC sensors	No	See the Wireless AC Sensor manual - Discontinued product

6.2. Connecting a USB GPS

A USB GPS can be used to enable remote tracking of vehicles or boats via the VRM Portal.

This allows:

- Remote position tracking via the VRM Portal
- Geofencing alerts, triggered when the system leaves a defined area
- Export of GPS tracks in .kml format for use in Google Earth, Navlink, and similar tools

Although Victron does not supply USB GPS modules, EGX support most third-party GPS receivers using the NMEA 0183 command set (at 4800 or 38400 baud). Simply plug the GPS unit into any USB port; it will be automatically recognised after a short delay.

Tested USB GPS models

Model	Chipset	Baud rate
Globalsat BU353-W	SiRF STAR III	4800
Globalsat ND100	SiRF STAR III	38400
Globalsat BU353S4	SiRF STAR IV	4800
Globalsat MR350 + BR305US combo	SiRF STAR III	4800
GlobalSat BU-353-N5	SiRF STAR IV	38400

6.3. Connecting a NMEA 2000 GPS

In addition to USB GPS receivers, a NMEA 2000 GPS can be used for remote tracking of vehicles or boats in the VRM Portal.

NMEA 2000 GPS compatibility requirements

To work with Victron GX devices, the third-party NMEA 2000 GPS sender must meet the following criteria:

Parameter	Required value
Device Class	60 - Navigation
Device Function	145 - Ownship Position (GNSS)
Required PGN	Must be transmitted in 129025 - Position (Latitude/Longitude)
Optional PGN	Must be transmitted in 129029 - Height, 129026 - Course & Speed

Most NMEA 2000-compatible GPS units should function correctly.

Tested and confirmed model:

- Garmin GPS 19X NMEA 2000

Physical connection to a GX device

The GX device and NMEA 2000 network use different connector types. Two options are available:

1. [VE.Can to NMEA 2000 cable](#) (Victron)
 - Enables connection between a GX device's VE.Can port and a standard NMEA 2000 network.
 - The built-in fuse can be inserted or removed to choose whether Victron powers the NMEA 2000 network.

 See warning below regarding system voltage compatibility.
2. [3802 VE.Can Adapter by OSUKL](#)
 - Ideal for connecting a single NMEA 2000 device (e.g., a tank sender) to a VE.Can network.
 - Can power lower-voltage NMEA 2000 networks directly from a 48 V Victron system.



System voltage compatibility

While Victron components accept up to 70 V on their CAN-bus ports, some NMEA 2000 devices do not. Many require a 12 V supply, and some may tolerate up to 30–36 V.

Before connecting, always check the datasheets of all NMEA 2000 devices in the system.

If lower network voltage is required:

- Use the OSUKL 3802 VE.Can Adapter, or
- Use the VE.Can to NMEA 2000 cable without its fuse, and supply power to the NMEA 2000 network using a separate 12 V NMEA 2000 power adapter cable (not supplied by Victron).

The VE.Can port on the GX device does not require external power to function.

6.4. Connecting Tank Level Sensors to the GX Tank Inputs

The tank level inputs are resistive and must be connected to a resistive tank sender. Victron does not supply tank senders. The built-in tank sensor connections do not support mA or voltage sensors; these types will require the [GX Tank 140](#) or replacement with a resistive sensor.

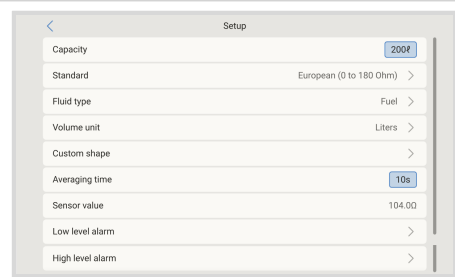

Sensors can be enabled or disabled in the I/O menu (Settings → Integrations → Tank and Temperature Sensors) of the GX device settings. Once enabled, the tank will appear in the Device list, where you can customise the setup to suit your specific installation.

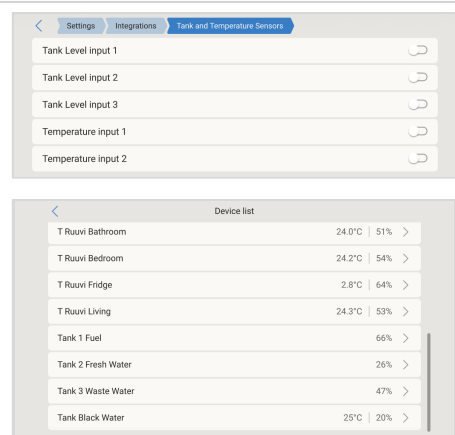

Set the tank volume unit (cubic meter, liter, imperial, or U.S. gallon) and capacity. You can also configure custom shapes for non-linear tanks, with up to 10 variations. For example, 50% of the sensor reading might correspond to 25% of the tank volume, while 75% could equal 90% of the volume.

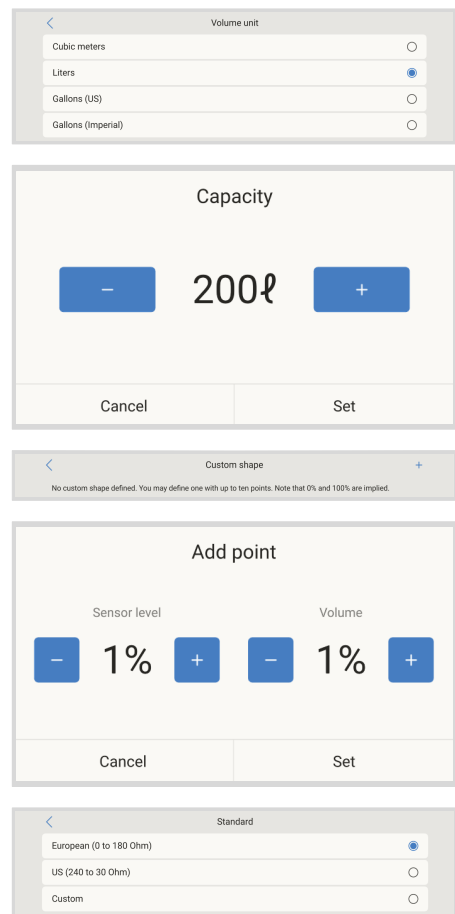

Each tank level port can be configured to work with either European (0-180 Ohm) or US (240-30 Ohm) tank sender standards, or you can set a custom resistance range between 0 and 300 Ohms (requires firmware v2.80 or higher).

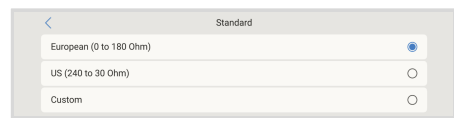

You can set the tank fluid type to Fuel, Fresh Water, Waste Water, Live Well, Oil, Black Water (sewage), Gasoline, Diesel, LPG, LNG, Hydraulic Oil, or Raw Water. Additionally, you can assign a custom name in the Device menu, which also displays device-related information such as connection type, product ID, and the VRM instance.

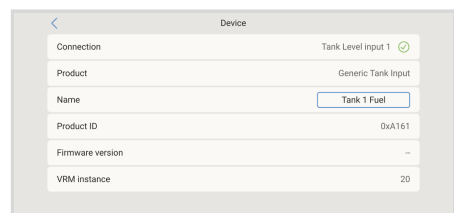
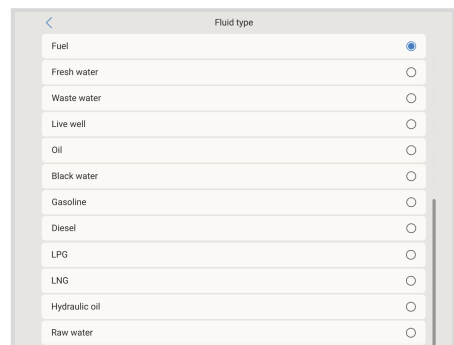

A separate low or high-level alarm can be configured and activated for each tank sensor.

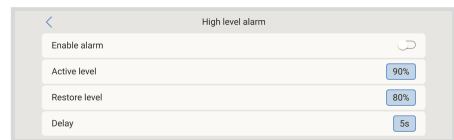
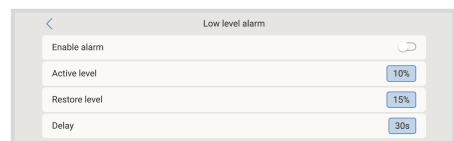

Tank level data is sent to the [VRM Portal](#) and can be monitored remotely. This data can also trigger the relay when set to 'Tank pump.' Additionally, tank levels can be viewed from various other locations within the GX environment:

- Device List of the GX device
- Sensor overview menu of the GX device
- Graphical overview of the GX device via the Levels button
- VRM Dashboard
- VRM advanced menu widgets
- VRM App widgets

To physically attach the tank probes requires a ferrule or exposed copper end of at least 10 mm+ to be inserted into the removable terminal block connector. Once correctly attached, you must use the orange tab if you wish to remove the secured wire.

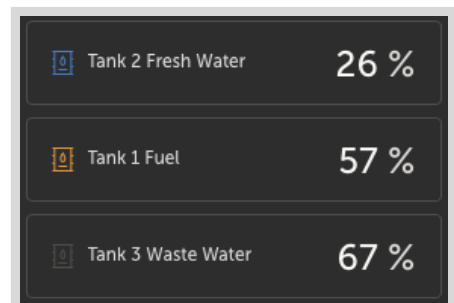
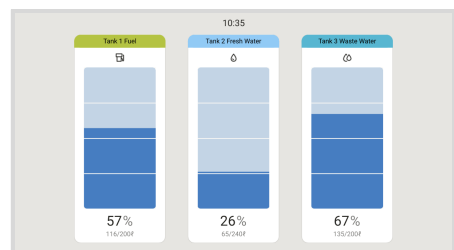

6.5. Increasing the number of tank inputs by using multiple GX devices

6.5.1. Introduction

The number of tank inputs on a GX device, such as the Cerbo GX and Venus GX, can be expanded by connecting multiple GX devices together in a VE.Can network. To do this, one GX device must be designated to be the "main" and the others(s) to be the "secondary" one(s). How this is done in practice is explained below.

There is no practical limit on how many GX devices can be used - except for the number of source addresses available in a VE.Can network, which is 252 addresses. For example, a Cerbo GX with 4 tank inputs uses up to 5 addresses: one for itself and one for each tank input.

6.5.2. Requirements

When using multiple GX devices in a VE.Can network, the following requirements must be followed to ensure correct operation:

1. Enable MQTT (part of [MFD App integration \[127\]](#)) on only one of the GX devices, not multiple.
2. Only the main GX device should be connected to the Ethernet network. The MFD App on Marine MFDs is not designed to work with multiple GX devices on one Ethernet network.
3. If using ModbusTCP, enable it on one GX device only.
4. Only the main GX device should be connected to VRM; it will also transmit tank levels received from the secondary units.
5. We strongly recommend connecting all VE.Bus and VE.Direct devices to the main GX device.

While connecting them to secondary GX devices works, it comes with limitations, such as:

- No remote configuration
- No DVCC control
- No remote firmware updates

Extending the VE.Direct ports via USB provides full functionality, which is therefore the recommended method. You can find more information on this in chapter [Powering the Ekran GX \[6\]](#).

6.5.3. Configuration step-by-step

1. First, on all GX devices, configure all tank inputs in Settings → Integrations → Tank and Temperature Sensors, only enable the inputs in use, and disable the others.
2. In Settings → Devices → Tank input → Device → Name, give each tank input its unique proper name, ie Fresh water 1, Gray water SB, Diesel Port, etc.
This is the only way to ensure they are distinguishable once connected.
3. Connect each GX device together on its VE.Can port and make sure to terminate on both ends.
There is no need to power the VE.Can network externally: while the GX devices don't power the VE.Can network, they do power their own internal CAN circuitry.
4. Now, on each GX device go to Settings → Connectivity → VE.Can and there:
 1. Verify that the chosen profile is VE.Can (250 kbit/s) or VE.Can & CAN-bus BMS (250 kbit/s)
 2. Enable the NMEA2000-out feature on all GX devices
 3. Assign each GX device its own unique number
 4. Use the “Check Unique ID Numbers” test feature to verify that everything is functioning correctly. Ideally, it should display: “OK: No other device is connected with this unique number.”
5. Lastly, on the main GX device, check if all sensors show up in the Device List and work well.

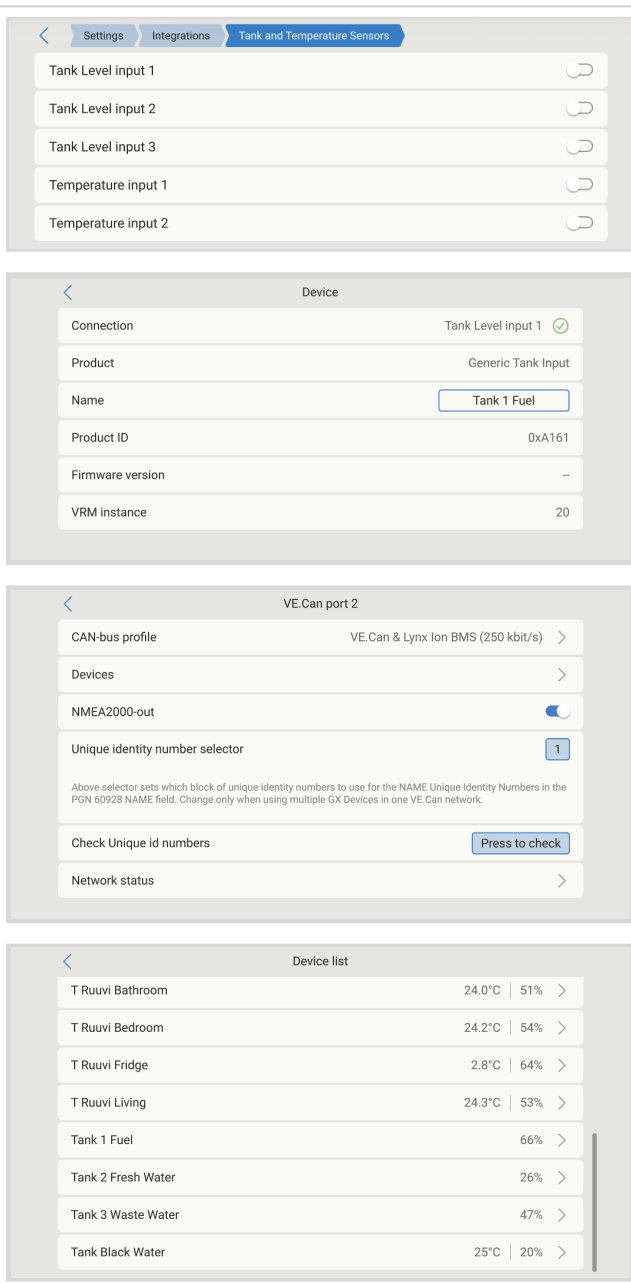

6.6. Connecting third-party NMEA 2000 tank senders

GX Devices can display data from compatible third-party NMEA 2000 tank senders.

Compatibility requirements

- Must transmit the NMEA 2000 Fluid Level PGN, 127505
- The NMEA 2000 device class/function must be either:
 - General (80) with function code Transducer (190) or Sensor (170)
 - Sensors (75) in combination with function code Fluid Level (150)
- Note: Multiple fluid levels from a single device or function are supported, provided each tank is assigned its own fluid or data instance.

Configuration support

Some senders allow fluid type and capacity configuration directly via the GX device menu.

For example, this works with the Maretron TLA100 and may be possible with other brands. Worth testing during setup.

Tested compatible NMEA 2000 tank senders

Brand	Model	Notes
Maretron	TLA100	Supports configuration via GX menus
Maretron	TLM100	
Navico	Fluid Level Sensor Fuel-0 PK	Part no. 000-11518-001 Needs a Navico display to configure the Capacity, Fluid type, and other parameters of the sensor. See voltage warning below
Oceanic Systems (UK) Ltd (OSUKL)	3271	Volumetric Tank Sender In case it doesn't work, it needs a firmware update. Contact OSUKL for that. See voltage warning below.
Oceanic Systems (UK) Ltd (OSUKL)	3281	Water Level Sender See voltage warning below
Gobius	Gobius C for NMEA 2000	

Most other NMEA 2000 tank senders are expected to work as well. If you successfully use one not listed here, let us know via [Community](#) → [Modifications](#).

Connecting to a GX device

Because VE.Can and NMEA 2000 use different connector types, two options are available:

- [VE.Can to NMEA2000 cable](#) (Victron)
 - Allows direct connection between NMEA 2000 and the VE.Can port on the GX device.
 - A fuse can be inserted or removed depending on whether the NMEA 2000 network should be powered by Victron equipment.

 See voltage warning below.
- [3802 VE.Can Adapter](#) by OSUKL
 - Especially suitable for connecting a single NMEA 2000 device (e.g. tank sender) to the VE.Can network.
 - Can power low-voltage NMEA 2000 networks (e.g. 12 V) directly from a 48 V Victron system.

**Voltage compatibility (24 V & 48 V Systems)**

While Victron GX devices tolerate up to 70 V on their CAN-bus interface, many NMEA 2000 devices do not. Most require 12 V, and some tolerate only up to 30–36 V.

If your system includes NMEA 2000 devices that cannot handle system voltage:

- Use the 3802 VE.Can Adapter (OSUKL), or
- Use the VE.Can to NMEA 2000 cable without its fuse, and power the NMEA 2000 network separately using a 12 V NMEA 2000 power adapter cable (not supplied by Victron).

The VE.Can port on the GX device does not require external power to operate.

6.7. Bluetooth connectivity requirements

To connect Bluetooth sensors such as those from Mopeka, Ruuvi or Safiery, the GX device must support Bluetooth:

- Some GX devices have built-in Bluetooth.
- Others can be retrofitted with a standard USB Bluetooth adapter (see the [Victron GX product range overview](#) for details).
- Even with built-in Bluetooth, adding a USB adapter can help extend range and improve reliability via USB extension cable placement.

USB Bluetooth adapters that have been tested and reported working:

USB Bluetooth adapter				
Insignia (NS-PCY5BMA2)	Logilink BT0037	TP-Link UB400(UN)	Kinivo BTD-400	Ideapro USB bluetooth adapter 4.0
Ewent EW1085R4	Laird BT820	Laird BT851	TP Link UB500	-

A list of additional adapters that are currently being tested or known not to work is available on the [Victron Community](#).

6.8. Mopeka Ultrasonic Bluetooth Sensors

Mopeka sensors enable ultrasonic measurement of liquid levels in both pressurised and non-pressurised tanks. Depending on the model, the sensor is mounted on either the top or bottom of the tank. Data such as liquid level, temperature, and sensor battery voltage is transmitted to the GX device via Bluetooth Low Energy (BLE).

To connect the sensor to the GX device via Bluetooth, the GX device needs Bluetooth functionality. For more information on Bluetooth requirements, limitations, and compatible USB Bluetooth adapters, see the [Bluetooth connectivity requirements \[44\]](#) section.

Supported Mopeka sensors

Mopeka sensor	Remarks
Mopeka Pro Check H2O	Requires Venus OS v3.14 or newer
Mopeka Pro Check LPG	
Mopeka Pro Check Universal	
Mopeka TD40 / TD 200	
Mopeka Pro Plus	
Mopeka Pro 200	



Only the sensors listed above are supported. Other Mopeka sensors, even with Bluetooth capability, are not compatible.

6.8.1. Installation

Installing the Mopeka sensor is straightforward. First, physically install the sensor according to the Mopeka installation instructions and configure it using the Mopeka Tank app (available on Google Play and the Apple App Store). Then continue with the setup on the GX device as follows:

1. Ensure Bluetooth is enabled in the Bluetooth sensors menu (enabled by default).
2. On the GX device, go to Settings → Integrations → Bluetooth sensors.
3. Move the Enable slider to the right to activate Bluetooth sensors.
4. Scroll down to locate your Mopeka sensor.
5. Move the corresponding slider to the right to activate it. The sensor should now appear in the Device List.
6. Repeat steps 1..5 for each additional sensor.

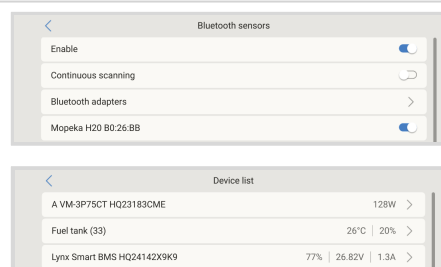

6.8.2. Configuration

1. Go to the Device list menu.
2. Scroll and select the desired sensor.
3. Click or tap on the selected sensor to open its overview menu.
4. Tap or click on the sensor to open its overview.
5. In the Setup menu, you can:
 - Adjust tank capacity
 - Select liquid type and volume unit
 - Set calibration values for empty and full tank levels
 - View current sensor reading and battery level
6. Once setup is complete, return to the Sensor overview menu.
7. Tap or click on Device to open the device settings menu.

8. In the Device menu, you can assign a custom name and view details such as connection type, product ID, and VRM instance.

Repeat steps 1–8 for each additional sensor.

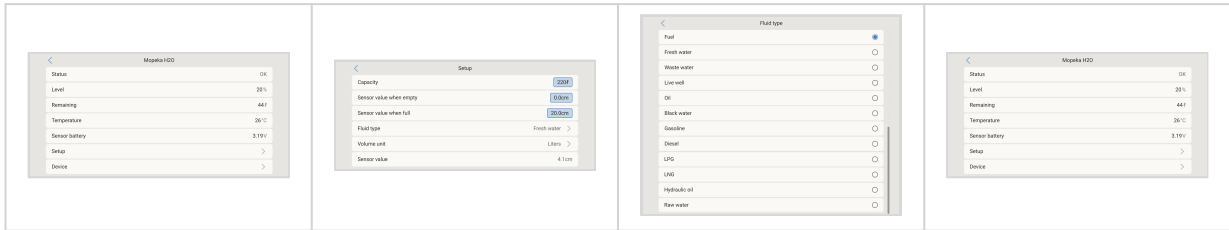

6.8.3. Tank level monitoring

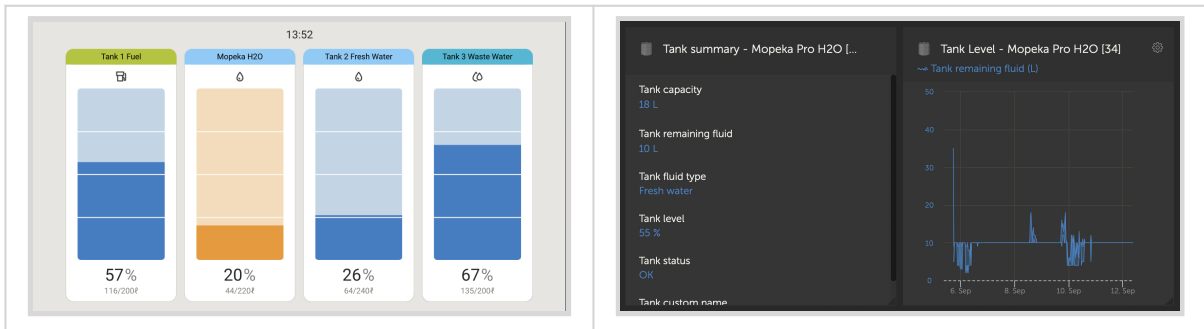

Tank levels can be monitored at various locations within the GX environment:

- Device List on the GX device
- Graphical overview on the GX device
- VRM Dashboard
- VRM advanced menu widgets
- VRM App widgets

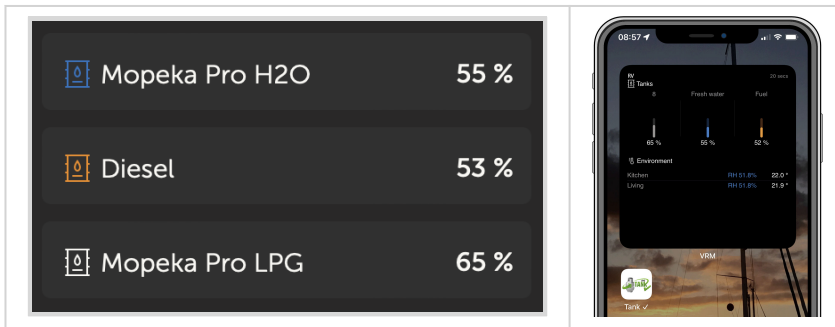

6.9. Safiery Star-Tank tank level sensor

The Safiery Star-Tank is a radar-based tank level sensor designed for top-mount installation. It can be affixed to non-metallic tanks using adhesive or mounted using the standard SAE 5-bolt pattern. The sensor communicates directly with a GX device via Bluetooth Low Energy (BLE). It is powered by a CR2744 coin cell battery, with an expected battery life of up to five years.

For detailed product and mounting instructions, refer to the Star-Tank manual available on the [Star-Tank product page](#).

To connect the sensor to the GX device via Bluetooth, the GX device needs Bluetooth functionality. For more information on Bluetooth requirements, limitations, and compatible USB Bluetooth adapters, see the [Bluetooth connectivity requirements \[44\]](#) section.

6.9.1. Installation

Installing the Star-Tank sensor is straightforward. First, follow the Star-Tank installation instructions and configure the sensor. Once this is done, continue with the steps below to complete the setup on the GX device.

1. Make sure Bluetooth is enabled in the Bluetooth sensors menu (enabled by default).
2. Go to Settings → Integrations → Bluetooth sensors menu.
3. Move the Enable slider to the right to enable Bluetooth sensors.
4. To find your Star-Tank sensor, scroll down until you see them.
5. To activate the sensor, move the slider to the right. It should now appear on the Device List.
6. Repeat steps 1..5 for more than one sensor.

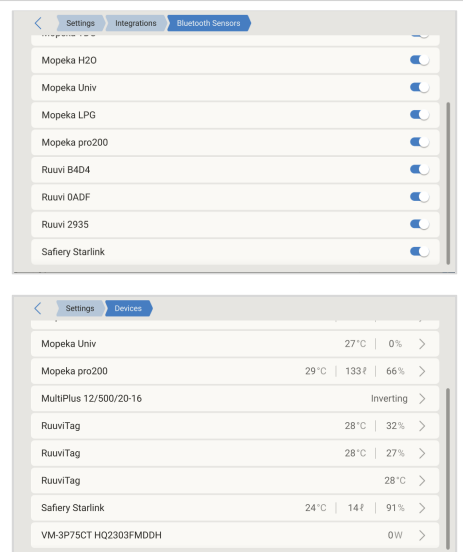

6.9.2. Configuration

1. Go to the Device list menu.
2. Scroll up or down and select the appropriate sensor.
3. Click or tap on the selected sensor to open its overview menu.
4. Click or tap on Setup to access the sensor's Setup menu.
5. In the Setup menu, you can change the tank capacity, select the liquid type and volume unit, set calibration values for empty and full tank levels, and view the current sensor value along with the battery level.
6. After completing the setup, return to the Sensor overview menu.
7. Click or tap on Device to open the device settings menu.
8. In the Device menu, you can assign a custom name to the sensor and view additional device information, such as connection type, product ID, and VRM instance.
Repeat steps 1 to 8 if you want to set up additional sensors.

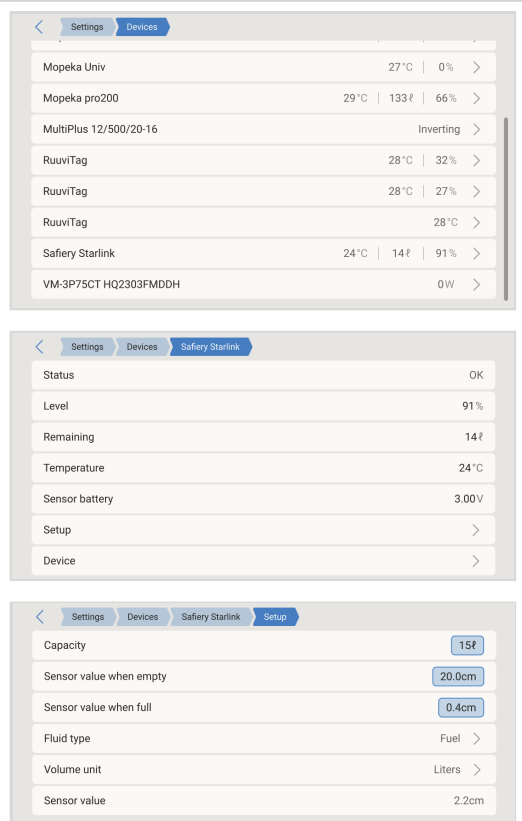

6.9.3. Tank level monitoring

Tank levels can be viewed in several locations within the GX environment:

- Devices list on the GX device
- Levels page on the GX device
- VRM Dashboard
- VRM advanced menu widgets
- VRM App widgets

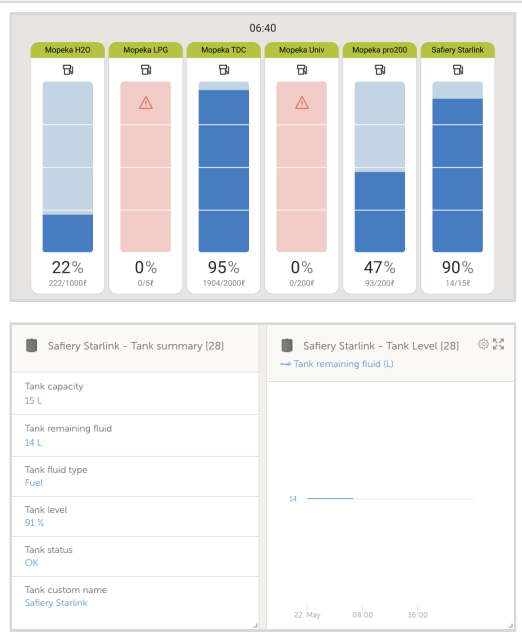

6.10. Gobius Bluetooth tank sensor support

The Gobius C and Gobius Pro are external, vibration-based tank level sensor designed for non-invasive installation. It attaches to the outside of the tank using adhesive pads, no drilling or internal fittings required. The sensor communicates directly with a GX device via Bluetooth Low Energy (BLE).

For detailed product and installation instructions, refer to the Gobius manual available on the [Gobius website](#).

To connect the sensor to the GX device via Bluetooth, the GX device needs Bluetooth functionality. For more information on Bluetooth requirements, limitations, and compatible USB Bluetooth adapters, see the [Bluetooth connectivity requirements \[44\]](#) section.

Supported Gobius Bluetooth sensors

Gobius sensor	Remarks
Gobius C	Requires at least firmware version 4.1.0.
Gobius Pro	

6.10.1. Installation

Installing the Gobius tank sensor is straightforward. First, follow the Gobius installation instructions and configure the sensor. Once this is done, continue with the steps below to complete the setup on the GX device.

1. Go to Settings → Integrations → Bluetooth Sensors.
2. Enable Bluetooth sensors (enabled by default).
3. Scroll down to find your Gobius sensor.
4. Enable the sensor.
5. Confirm it now appears in the Devices list.
6. Repeat steps 3..5 for additional sensors.

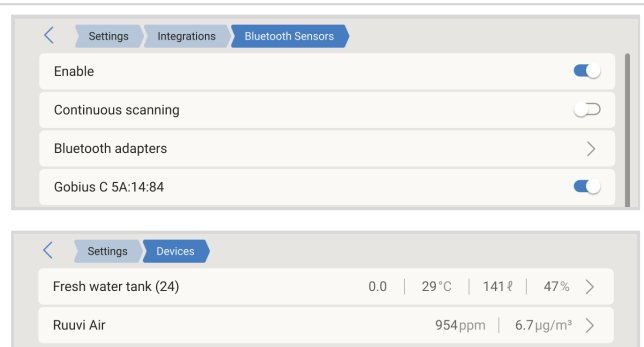

6.10.2. Configuration

1. Go to Devices list.
2. Select the Gobius sensor to open the sensor overview.
3. Select Setup.
4. Configure the tank capacity, liquid type, volume unit, and the empty/full calibration values. Custom-shaped tanks can also be configured, with up to 10 steps. The current sensor value is shown here.
5. You can set and enable high and low level alarms in the relevant submenu.
6. After completing the setup, return to the sensor overview menu.
7. Select Device to open the device settings.
8. In the Device menu, you can assign a custom name to the sensor and view additional device information, such as connection type, product ID, and VRM instance.
9. Repeat these steps for additional sensors.

Settings > Devices > Fresh water tank (24)	
Status	OK
Level	47%
Remaining	141 l
Temperature	29°C
Setup	>
Device	>

Settings > Devices > Fresh water tank (24) > Setup	
Capacity	300l
Sensor value when empty	20.0cm
Sensor value when full	0.0cm
Fluid type	Fresh water >
Volume unit	Litres >
Custom shape	>
Sensor value	10.6cm
Low level alarm	>
High level alarm	>

Settings > Devices > Fresh water tank (24) > Device	
Connection	Bluetooth LE
Product	Gobius tank sensor
Name	Custom name
Product ID	0xC02E
Firmware version	1.1.0
VRM instance	24
Device name	Gobius C 5A:14:84

6.10.3. Tank level monitoring

Tank levels can be viewed in several locations within the GX environment:

- Devices list on the GX device
- Levels page on the GX device
- VRM Dashboard
- VRM advanced menu widgets
- VRM App widgets

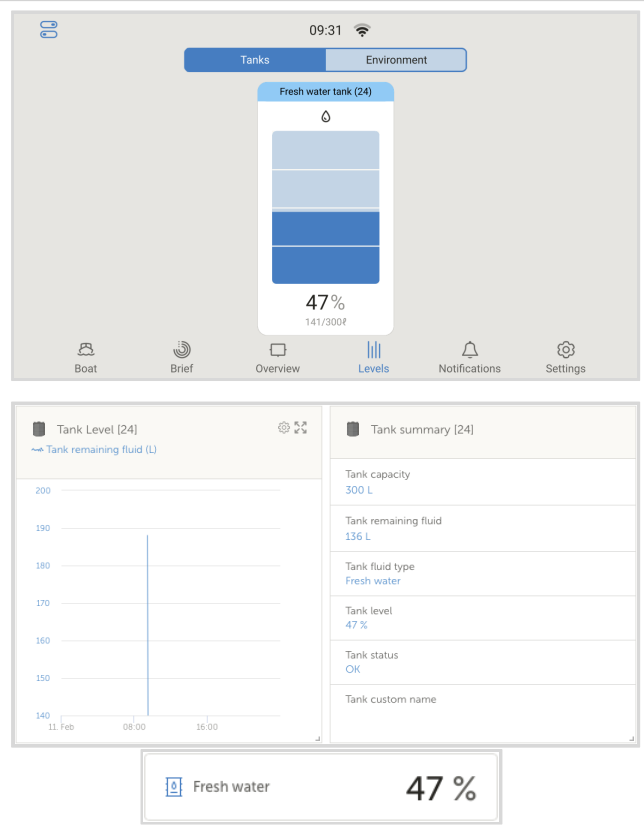

6.11. Wireless Bluetooth Ruuvi temperature sensors

Ruuvi sensors transmit temperature, humidity, and atmospheric pressure wirelessly to a GX device via Bluetooth.

To connect the sensor to the GX device via Bluetooth, the GX device needs Bluetooth functionality. For more information on Bluetooth requirements, limitations, and compatible USB Bluetooth adapters, see the [Bluetooth connectivity requirements \[44\]](#) section.

Installation procedure

Ensure Bluetooth is enabled in the Bluetooth menu (enabled by default). To do this, go to Settings → Integrations → Bluetooth Sensors, and click 'Enable' to activate Bluetooth temperature sensors.

The Bluetooth adapters submenu displays a list of available Bluetooth adapters. The 'Continuous Scanning' option allows for constant scanning of new Bluetooth sensors. However, be aware that enabling this option can affect the WiFi performance of the GX device. Only enable it if you need to search for new Bluetooth sensors; otherwise, it's best to keep it disabled.

The sensor will appear in the menu as 'Ruuvi ####' with a 4-digit hexadecimal device ID. Enable the specific Ruuvi sensor. Any previously installed and activated sensors will be displayed with their user-defined names, if set.

The sensor should now be visible in the Device list - by default, it is labelled 'RuuviTag'

In the temperature sensor setup menu, you can adjust the type (choose between Battery, Fridge, and Generic). The Device menu allows you to set a custom name for the sensor and provides additional information such as connection type, Product ID, and VRM instance.

Battery Life and Status for Ruuvi Sensors:

Ruuvi sensors use a replaceable CR2477 3V lithium coin cell, which typically lasts over 12 months, depending on the ambient temperature.

• Battery Information:

- The internal battery voltage and status are displayed in the sensor's menu.

• Battery Status Indicators:

- OK status: Battery voltage $\geq 2.50V$
- Sensor battery low status: Battery voltage $\leq 2.50V$

Low Battery Warning:

A low battery warning will appear on the Remote Console. If the GX device reports to VRM, the warning will also appear there.

The warning threshold is temperature-dependent:

- Below 20°C: Threshold is 2.0V
- Between -20°C and 0°C: Threshold is 2.3V
- Above 20°C: Threshold is 2.5V

You can update the Ruuvi's firmware using Ruuvi's dedicated phone app, though this is only necessary if you're experiencing issues.

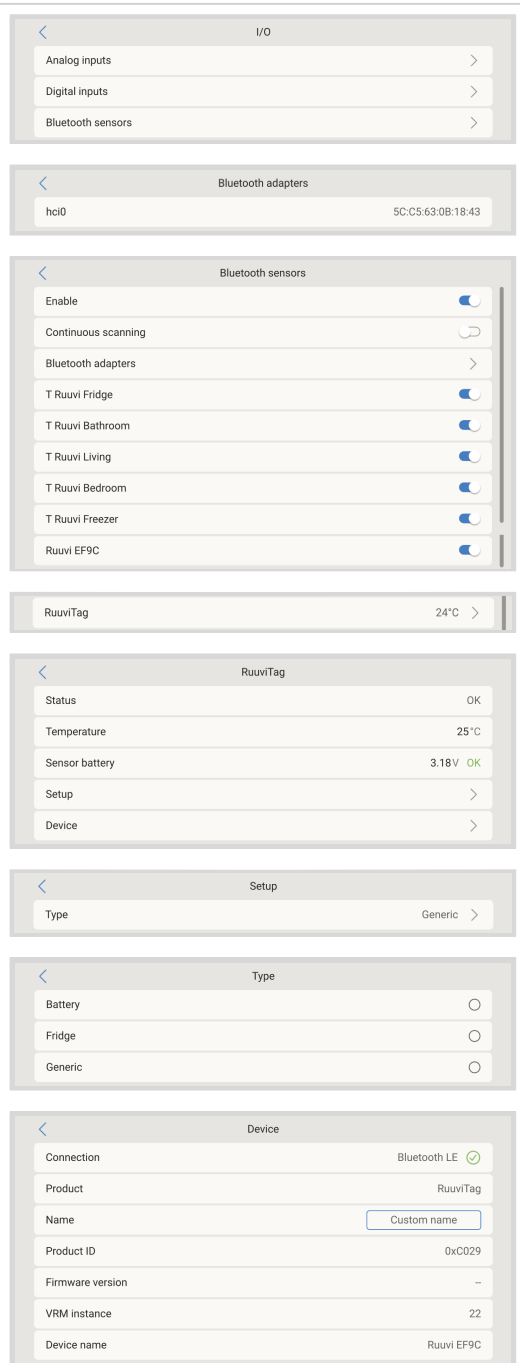

6.12. Ruuvi Air support

Ruuvi Air is an advanced indoor air quality sensor that provides real-time monitoring of multiple environmental parameters, including CO₂, particulate matter (PM1, PM2,5, PM4, PM10), volatile organic compounds (VOC), nitrogen oxides (NOx), temperature, humidity, and air pressure.

For detailed product and mounting instructions, refer to the [Ruuvi Air quick start guide](#).

A GX device can read the following parameters from the Ruuvi Air via Bluetooth Low Energy (BLE):

- Temperature
- Relative humidity
- Air pressure
- Particulate matter (PM2,5)
- Carbon dioxide (CO₂)
- Volatile organic compounds (VOC) index
- Nitrogen oxides (NOx) index



6.12.1. Installation

Installing the Ruuvi Air sensor is straightforward. First, follow the Ruuvi Air Quick Start Guide and configure the sensor. Once this is done, continue with the steps below to complete the setup on the GX device.

1. Make sure Bluetooth is enabled in the Bluetooth sensors menu (enabled by default).
2. Go to Settings → Integrations → Bluetooth sensors menu.
3. Move the Enable slider to the right to enable Bluetooth sensors.
4. To find your Ruuvi Air sensor, scroll down until you see them.
5. To activate the sensor, move the slider to the right. It should now appear on the Device List.

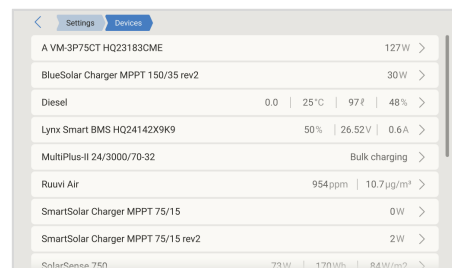
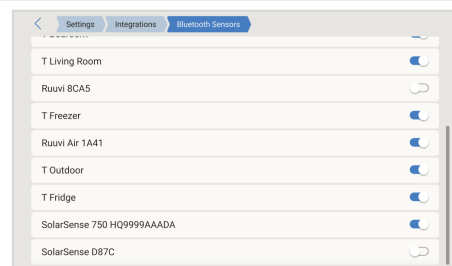

6.12.2. Configuration

1. Go to the Device list menu.
2. Scroll up or down and select the appropriate sensor.
3. Click or tap on the selected sensor to open its overview menu.
4. Click or tap on Setup to access the sensor's Setup menu.
5. In the Setup menu, you can change the tank capacity, select the liquid type and volume unit, set calibration values for empty and full tank levels, and view the current sensor value along with the battery level.
6. After completing the setup, return to the Sensor overview menu.
7. Click or tap on Device to open the device settings menu.
8. In the Device menu, you can assign a custom name to the sensor and view additional device information, such as connection type, product ID, and VRM instance.
Repeat steps 1 to 8 if you want to set up additional sensors.

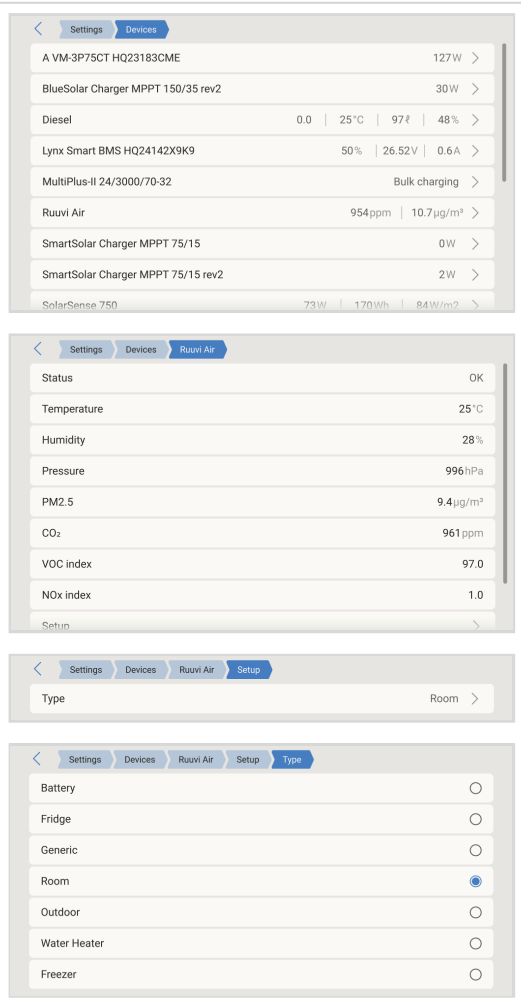

6.12.3. Monitoring

Sensor levels can be viewed in several locations within the GX environment:

- Devices list on the GX device
- Levels page on the GX device (temperature and relative humidity)
- VRM Dashboard (VOC index, NOx index, PM2.5 level, CO₂ level, RH, temperature, air pressure)
- VRM advanced menu widgets (VOC index, NOx index, PM2.5 level, CO₂ level, RH, temperature, air pressure)
- VRM App widgets (temperature and relative humidity)

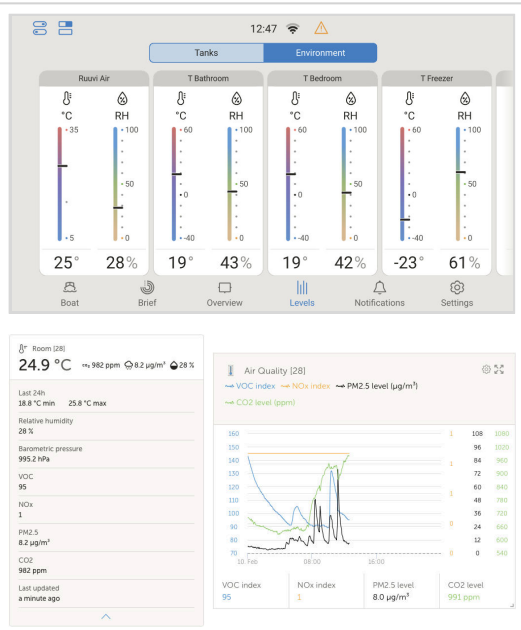

6.13. Connecting IMT Solar Irradiance, Temperature and Wind Speed Sensors

IMT Technology GmbH offer a range of digital silicon irradiance sensor models within the [Si-RS485 series](#), all of which are compatible with GX devices.

Compatibility

- The optional sensors [external module temperature](#), [ambient temperature](#), and [wind speed](#) are also supported.
- These optional sensors can be connected to the solar irradiance sensor via pre-installed plugs or pre-wired connections (for module temperature and ambient temperature only). When external sensors are connected through an appropriate solar irradiance sensor, all measurement data is transmitted to the Victron GX device using a single interface cable.
- Each model in the Si-RS485 series of solar irradiance sensors varies in its compatibility with external sensors (some come pre-wired with external sensors), so it's important to carefully consider future needs and requirements before making a purchase.
- It is also possible to connect an independent [IMT Tm-RS485-MB module temperature sensor](#) (displayed as 'cell temperature') or [IMT Ta-ext-RS485-MB ambient temperature sensor](#) (displayed as 'external temperature') directly to the Victron GX device, either without a solar irradiance sensor or alongside one.

Operation

- The IMT Si-RS485 series solar irradiance sensors utilise an RS485 electrical interface and the Modbus RTU communication protocol.
- To operate correctly, the Victron GX device must be running version 2.40 or later. IMT sensors with firmware versions earlier than v1.53 are also supported; for more information, please contact IMT.
- The physical connection to the Victron GX device is made via a USB port and requires a [Victron RS485 to USB interface cable](#).
- A suitable external DC power source (12 to 28 VDC) is also required, as the sensor is NOT powered via USB.
- Recent IMT models feature a second temperature sensor, which is also supported.

Wiring Connections

The schematic in the installation guide below illustrates the wiring configuration for a typical installation.

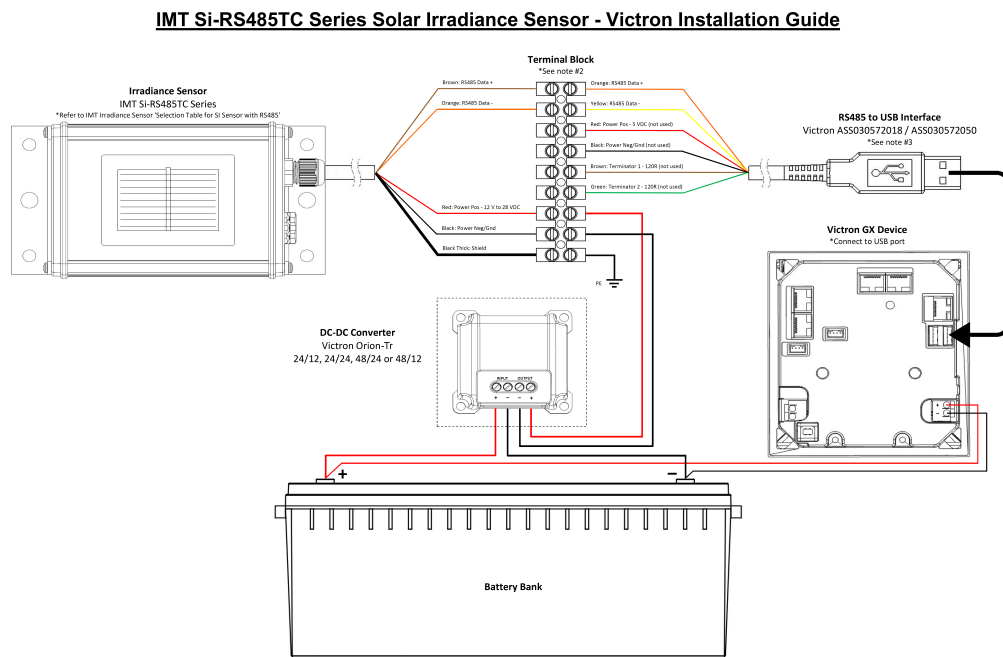

Wire connections

Si-Sensor	Victron RS485 to USB interface	Signal
Brown	Orange	RS485 Data A +
Orange	Yellow	RS485 Data B -
Red	-	Power Pos - 12 to 28VDC
Black	-	Power Neg/Gnd - 0VDC
Black (thick)	-	Ground / Cable Shield / PE
-	Red	Power Pos - 5VDC (not used)
-	Black	Power Neg/Gnd - 0VDC (not used)
-	Brown	Terminator 1 - 120R (not used)
-	Green	Terminator 2 - 120R (not used)

Installation Notes

- The maximum DC power supply voltage permitted for the IMT Si-RS485 series solar irradiance sensor range is 28.0VDC. For 24V and 48V battery banks/systems, an appropriate [Victron DC-DC converter](#) (24/12, 24/24, 48/12 or 48/24), or AC-DC adapter must be used in the installation.
- For 12V battery banks or systems, the IMT Si-RS485 series solar irradiance sensors can be powered directly from the battery bank and will continue to operate down to a minimum voltage of 10.5V (as measured at the sensor, please account for voltage drop in the cable).
- For detailed wiring, installation notes, and specifications, refer to the [IMT Si-RS485 series solar irradiance sensor 'Quick Reference Guide'](#) and the [Victron RS485 to USB interface cable 'Datasheet'](#).

To ensure signal integrity and robust operation, please adhere to the following guidelines:

- Extension cabling must comply with the minimum cross-sectional area specifications listed in the related table, depending on DC supply voltage and cable length.
- Extension cabling should have appropriate shielding and twisted pair cores.
- If the total cable length exceeds 10m or if there are installation-specific interference issues, the original cable attached to the Victron RS485 to USB interface should be reduced to a maximum length of 20cm. In such cases, use high-quality cabling for the entire length, rather than just the extension.
- Ensure that cabling is installed separately from main DC or AC power cabling.
- All wiring must be properly terminated (including unused wires) and adequately isolated from weather and water ingress.
- Do not open or tamper with the sensor housing during installation, as this will compromise sealing integrity and void the warranty.

The IMT Si-RS485TC series solar irradiance sensor features internal galvanic isolation (up to 1000V) between the power supply and RS485 Modbus circuits, making the non-isolated Victron RS485 to USB interface suitable for most installations.

However, if an isolated RS485 to USB interface is preferred, the only compatible device is [Hjelmslund Electronics USB485-STIXL](#) (other type will not be recognised by the GX device).

Multiple Sensors

- It is not possible to connect multiple IMT Si-RS485 series solar irradiance sensors to a GX device; additional sensors will be ignored.

Configuration

Generally, no special or additional configuration is required - the default 'as shipped' configuration is compatible for communication with a Victron GX device.

However, if the IMT Si-RS485 series solar irradiance sensor has been previously used in another system or if the settings have been changed for any reason, it is necessary to restore the default configuration before further use.

To revise the configuration, download the IMT 'Si-MODBUS-Configurator' from the [software downloads section](#). Follow the instructions in the Si-Modbus-Configurator manual, download from the same link and check or update the following settings:

MODBUS Address: 1	Baud Rate: 9600	Data Format: 8N1 (10 Bit)
--------------------------	------------------------	----------------------------------

For further support related to configuration of the IMT Si-RS485 Series irradiance sensors, please contact IMT Technology directly.

User Interface - GX device

Once the Victron GX device is connected and powered on, the IMT Si-RS485 Series irradiance sensor will be automatically detected within a few minutes and will appear in the 'Device list' menu.



Within the 'IMT Si-RS485 Series Solar Irradiance Sensor' menu, all available parameters will be automatically displayed (depending on the connected sensors) and will update in real time.

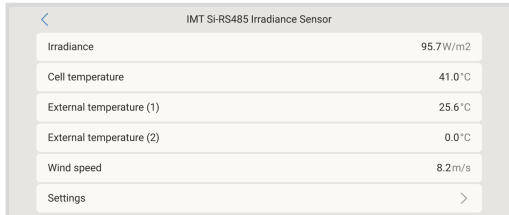

Within the 'Settings' sub-menu, you can manually enable or disable any optional or additional external sensors connected to the IMT Si-RS485 Series irradiance sensor.

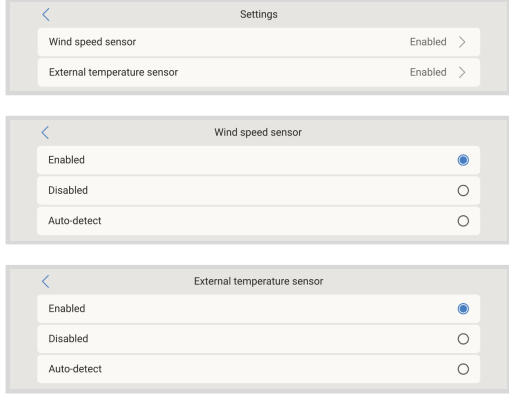

Data Visualisation - VRM

To view logged historical data on the VRM portal, expand the 'Meteorological Sensor' widget list and select the 'Meteorological Sensor' widget.

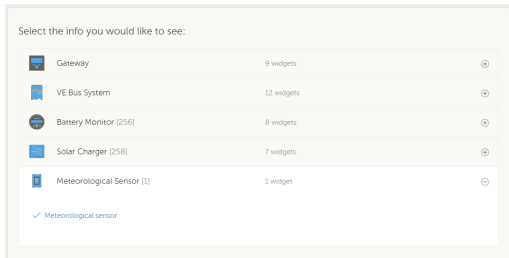

Data from all available sensor types will be automatically displayed in the graph. You can enable or disable individual sensors or parameters by clicking on their names in the legend.

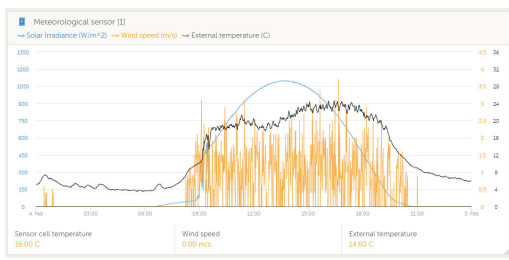

6.14. Connecting a SmartSwitch DC4

The [SmartSwitch DC4 by Energy Solutions](#) is a configurable, four-channel DC load controller. It is internally powered and features an isolated CAN interface, ensuring reliable integration into marine, mobile, and industrial systems.

Features

- 12 V or 24 VDC operation
- CAN bus controlled
- 4 channels providing load control, lamp dimming and digital sensing
- User-definable current limiting
- Thermal overload protection
- On-module control and output status indication
- For full details, refer to the SmartSwitch DC4 manual, available on the [product page](#).

Output modes

Each of the four channels can be configured in one of the following modes:

- Latched - Toggle (on/off) output.
- Momentary - Output remains active only while the button is pressed.
- Dimming - Lamp dimming via 120 Hz pulse-width modulation (PWM).

Installation

For physical and electrical installation instructions, see the Quick Start Guide available on the [product page](#).

VE.Can connection

The SmartSwitch DC4 features two RJ45 connectors for VE.Can communication with the GX device. It can either be:

- Looped through, when part of a chain of VE.Can devices, or
- Terminated using an RJ45 terminator, if it is the final device in the VE.Can network.

The SmartSwitch DC4 includes two RJ45 connectors for VE.Can communication with the GX device. The device can either be looped through or terminated using an RJ45 terminator if it is placed at the end of the VE.Can network.



Ensure that the SmartSwitch DC4 is connected to the VE.Can port on the GX device — not the VE.Bus port.



SmartSwitch DC4 connected at the end of the VE.Can network

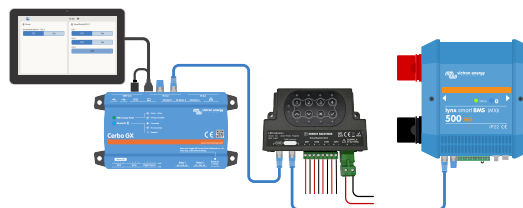

SmartSwitch DC4 looped through

GX device configuration

Once connected and powered, the SmartSwitch DC4 will appear in the Devices list on the GX device.

The SmartSwitch device page displays:

- Module state
- Supply voltage
- Channel state
- Channel current
- Channel mode

A dedicated Setup menu allows configuration of each channel individually.

On each individual channel page in the Setup menu, the following options are available:

- Custom name: Assign a custom name to the channel. (Note: the module name can be changed via the Device menu).
- Group: Allocate the channel to a group.
- Type: Select the output mode: Latching (Toggle), Momentary, or Dimmable.
- Fuse rating: Set the fuse rating (2–5 A).

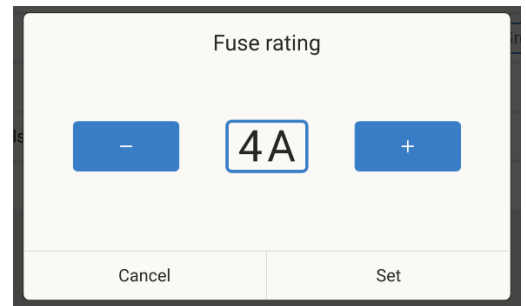
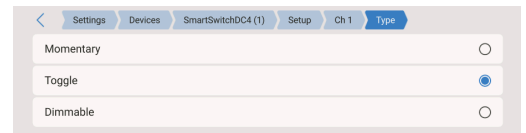
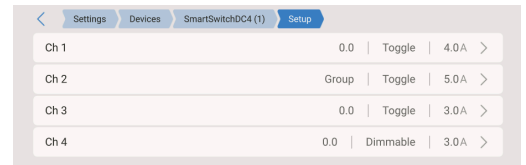

Grouping outputs

Each channel can be grouped by assigning a group name on the channel's setup page.

Channels with the same group name are displayed together in a single group card on the Switch pane. This makes it easy to combine related outputs, for example, grouping all lighting channels under one tile.

Channels without a group name will appear in a card labelled with the module name.

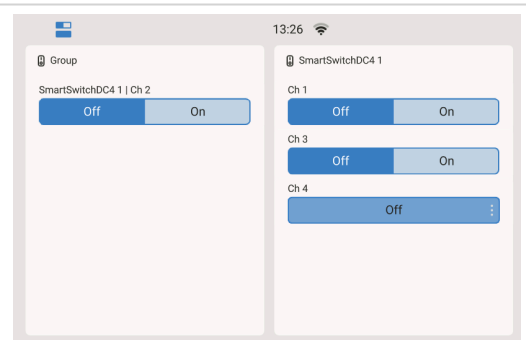

6.15. Shelly Energy Meters & Switches support

Venus OS supports Shelly Gen2 and later devices that provide digital switching, dimming, RGBW control, energy metering, or a combination of these features. Sensors and other Shelly hardware are not supported.

Detected Shelly devices are disabled by default and must be enabled manually.

Depending on the model, the Shelly appears in Venus OS as a switch, an energy meter, or both.

Features

- Auto-discovery of Shelly devices in the same network as the GX over mDNS.
Shelly devices are integrated over the local network. In most cases, compatible Shelly devices are discovered automatically via mDNS. The GX device then connects to the Shelly device via its WebSocket endpoint.
- Manually adding Shelly devices by submitting an IP address. If a device is not discovered automatically, it can be added manually by entering its IP address.
- Enabling/disabling individual channels.
- Switching the output from the switching pane in the GUI. The output type depends on the device capabilities (simple switching device supports momentary and toggle, RGBW supports the RGBW and RGB color wheel).
- Naming the device and channel. The Shelly device name is synchronised with the service custom name. For switching outputs, the channel name is synchronised with the output's custom name.
- Using a dedicated EM (one without switching capabilities) with one of the following roles: Genset, AC load or PV Inverter. Note that the Grid role is not supported.
- An energy metering device with switching capabilities (like Shelly plus plug S) only supports the EM role AC load.

Supported Shelly devices

The following devices have been tested to work correctly:

- Shelly plus plug S (SW +EM)
- Shelly Pro 4PM (SW +EM)
- Shelly Pro 1PM (SW + EM)
- Shelly Pro 3EM (3 phase EM only)
- Shelly 1PM Gen4 (SW + EM)
- Shelly Mini 1PM Gen4 (SW + EM)
- Shelly Mini 1 Gen4 (SW only)
- Shelly Dimmer Gen3 (Dimmable AC load switch)
- Shelly Plus RGBW PM (Dimmable 4-channel RGBW controller). In 'Lights' profile (4 separate dimmable channels), only 1 dimmable channel will show up.

Limitations

- Password-protected devices are not supported. Shelly devices secured with a password will not appear in the device list.
- Device and channel naming: It is not possible to assign individual names to each EM channel of a multi-channel device. The channel name is synchronised with the Shelly device name. This only affects multi-channel EM devices (with or without switching), such as the Pro 4PM.
- Only one dimming channel per device is supported. For example, on the Shelly RGBW PM in the Light profile, only the first channel can be used.
- The CCT component is not supported (for example Shelly Pro RGBWW PM). On RGBWW devices, only the RGB channels are available.
- For EM devices with a potential-free contact (for example Pro EM50), only the potential-free contact is shown as a switching channel.
- Single-channel EM devices are not supported (for example Shelly 1 EM Mini Gen4).
- Shelly add-ons are not supported.
- Connecting to or configuring a Shelly device via Bluetooth is not supported.

- Using Shelly switching devices for other functions (for example Generator start/stop, alarm relay, etc.) is not supported natively. In Venus OS v3.70, such functions are only supported on the onboard GX relays. Advanced automation can be implemented using Node-RED.

6.15.1. Installation

Installing a Shelly device is straightforward. First, follow the Shelly installation instructions and connect the Shelly device to the same network as the GX device. Once this is done, continue with the steps below to complete the setup on the GX device.

- Go to Settings → Integrations → Shelly Devices. All detected Shelly devices are listed here.
- Enable the discovered Shelly device.
If the device you are looking for is not listed, press Refresh. Also ensure the Shelly device is connected to the same network as the GX device.
If the Shelly device is on a different network, you can add it manually by entering its IP address.
- Confirm it now appears in the Devices list.
- Repeat steps 1..3 for additional devices.

6.15.2. Configuration

Depending on the Shelly device type (switch, dimmer, RGBW controller, or energy meter), the available configuration options and display settings differ. As a result, some menus shown in this chapter may not appear on all systems.

Shelly switches

- Go to Devices list.
- Select the Shelly device to open the device overview.
- Select Channel [x].
In the Channel menu you can:
 - Set a custom name (used in the Switches pane in Remote Console and on VRM).
 - Assign the device to a group, which can contain other switch devices in the Switches pane.
 - Change the switch type from Toggle to Momentary.
 - In Show controls, select where the switch controls are shown (local Switches pane and/or VRM only, or Off).
- Return to the device overview.
- Select Device to open the device settings.
In the Device menu you can set a local device name (used on the GX device) and view additional device information, such as connection type, product ID, and VRM instance.
- Repeat these steps for additional devices.

Shelly energy meters

Use the GX device menus to configure how the Shelly energy meter is used and how it is displayed.

1. Go to Devices list.
2. Select the Shelly device to open the device overview.
3. In Setup, configure the following:
 - Role** - select how the energy meter is used in the system:
 - AC load
 - PV Inverter
 - Generator
 - Position** - Select where the energy meter is installed:
 - AC Input
 - AC Output
 - Phase Setting** - assign the measured phase:
 - AC Phase L1
 - AC Phase L2
 - AC Phase L3
4. Return to the device overview.
5. Select Device to open the device settings.
6. Select Device to open the device settings.

In the Device menu you can set a custom name and view additional device information, such as connection type, product ID, and VRM instance.
7. Repeat these steps for additional devices.

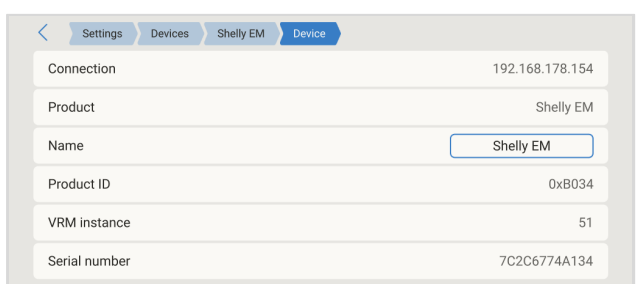
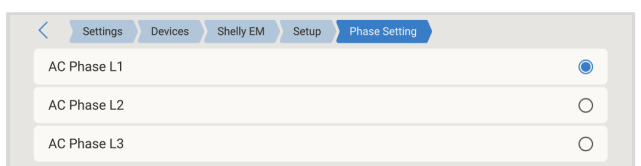
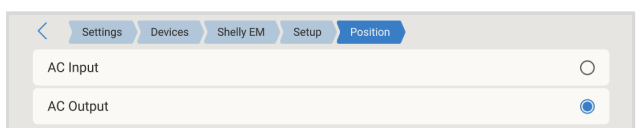
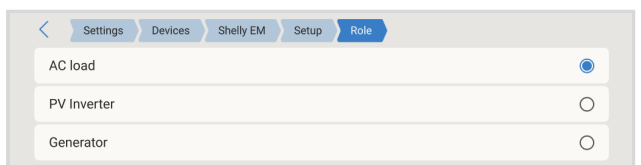
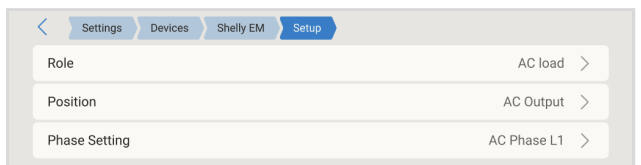
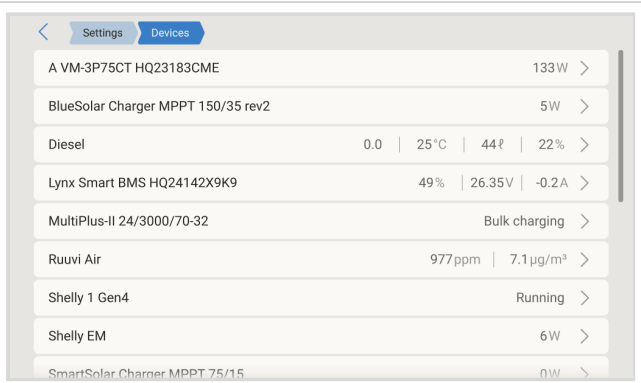

6.15.3. Monitoring

Depending on the Shelly device type and channel configuration, Shelly devices can be monitored (and, where supported, controlled) in the following locations:

- Devices list on the GX device
- Switch pane on the GX device
- VRM Dashboard
- VRM advanced menu widgets
- VRM App widgets

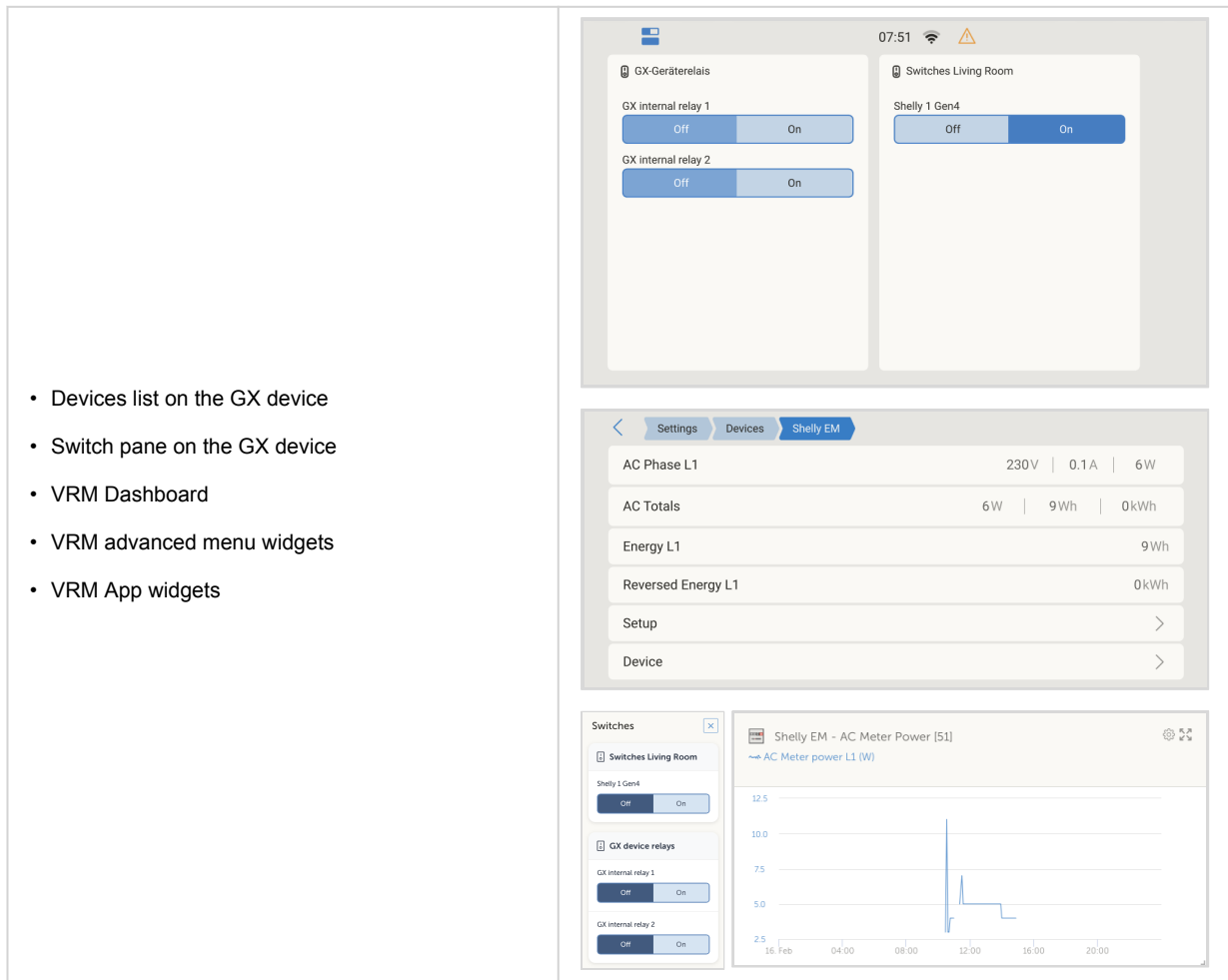

6.16. Garmin EmpirBus digital switching support

Garmin EmpirBus digital switching is supported in the Switch pane on the GX device. EmpirBus channels can be monitored and controlled directly from the GX user interface.

- GX alarms are transmitted onto the NMEA 2000 network. Compatible Garmin MFDs visualise these alerts, providing immediate awareness of system warnings at the helm.

6.17. Reading generic alternator data from compatible NMEA 2000 DC sensors

The GX device can read voltage, current, and temperature data from generic alternators when connected to compatible third-party NMEA 2000 DC sensors.

Note: This data is used for display only. It is not used for system calculations or control functions.

NMEA 2000 sensor requirements

To ensure compatibility, the NMEA 2000 DC sensor must meet the following criteria:

Requirement	Value
Device Class	35 – Electrical Generation
Device Function	141 – DC Generator
DC Type	Must be set to Alternator in PGN 127506 DC Details
Data PGN	127508 – Battery Status (must transmit voltage, current, temperature)

Most NMEA 2000 DC sensors are expected to work.

Confirmed compatible devices

- [Across Ocean Systems DC Current Sensors](#)

Physical connection to a GX device

NMEA 2000 networks and GX devices use different connector types. Two adapter solutions are available:

1. [VE.Can to NMEA 2000 cable](#) (Victron)
 - Allows connection between a GX device's VE.Can port and a standard NMEA 2000 network
 - The internal fuse can be included or removed to allow or prevent Victron equipment from powering the NMEA 2000 network

 See voltage warning below.
2. [3802 VE.Can Adapter by OSUKL](#)
 - Ideal for connecting a single NMEA 2000 device (e.g. alternator sensor) to the VE.Can network
 - Can provide 12 V power to low-voltage NMEA 2000 devices from a 48 V Victron system



Voltage compatibility (24 V & 48 V Systems)

While Victron GX devices tolerate up to 70 V on their CAN-bus interface, many NMEA 2000 devices do not. Most require 12 V, and some tolerate only up to 30–36 V.

If your system includes NMEA 2000 devices that cannot handle system voltage:

- Use the 3802 VE.Can Adapter (OSUKL), or
- Use the VE.Can to NMEA 2000 cable without its fuse, and power the NMEA 2000 network separately using a 12 V NMEA 2000 power adapter cable (not supplied by Victron).

The VE.Can port on the GX device does not require external power to operate.

6.17.1. Wakespeed WS500 alternator regulator support

Introduction

The WS500 is an external smart alternator regulator with CAN-bus and NMEA 2000 communication, designed primarily for marine and RV applications. When connected to a GX device, the Wakespeed WS500 allows alternator performance monitoring and DVCC-based control.

Requirements

To integrate the WS500, the following conditions must be met:

1. Venus OS firmware v2.90 or later on the GX device
2. Wakespeed WS500 firmware 2.5.0 or later on the WS500 controller
3. The WS500 must be connected to the VE.Can port of the GX device. Connection via the BMS-Can port (e.g. on Cerbo GX) is not supported for monitoring

Requirements for DVCC control

1. Venus OS firmware v3.30 or later on the GX device
2. Wakespeed WS500 firmware 2.5.2 or later on the WS500 controller
3. The Wakespeed-supplied current shunt must be installed at the alternator
4. WS500 must be configured with "Shunt at Alternator" toggled on (Wakespeed application: System Tab on the Configuration screen)
5. Define the Alternator Capacity in Amps on the Alternator Tab
6. NMEA2000 Support (System > Expert Mode) must be enabled

Wiring the WS500 to VE.Can

Both the WS500 and VE.Can use RJ45 connectors for CAN communication, but with different pinouts. A standard (straight) UTP network cable will not work. A custom crossover cable is required.

Refer to the below diagram for pinout details:

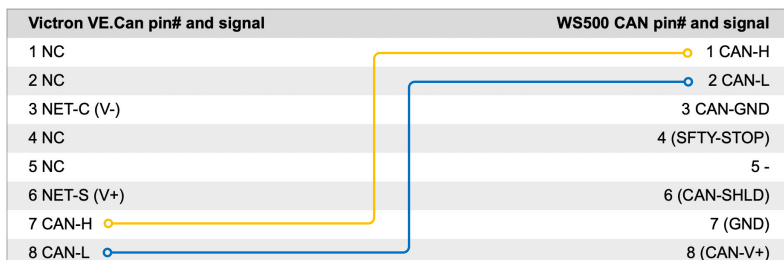

CAN pin mapping:

- VE.Can: pin 7 = CAN-H, pin 8 = CAN-L
- WS500: pin 1 = CAN-H, pin 2 = CAN-L

Wiring requirement:

- Pin 1 (WS500) → Pin 7 (VE.Can)
- Pin 2 (WS500) → Pin 8 (VE.Can)

Connect the end with pin 7/8 to the VE.Can port on the GX device. The other end (pin 1/2) connects to the WS500. Both ends must be terminated.

Cable colours are not relevant when making the crossover cable yourself. Wakespeed also offers a pre-made cable with a blue RJ45 plug—this end connects to the VE.Can port.



Please note that the black terminators supplied by Wakespeed and the blue terminators supplied by Victron are not interchangeable. Therefore: insert the Victron terminator on the Victron side of the network, and insert the Wakespeed terminator into the Wakespeed.

Wiring Example

The example below shows an overview of the recommended wiring based on an installation with a Lynx Smart BMS, Lynx Distributors and a Ekranox GX.

The correct placement of the alternator shunt (not to be confused with the shunt of the BMV or SmartShunt) is important here for the correct connection of the current sense wire.

For complete wiring between the WS500 and alternator, see the WS500 and the alternator manuals.

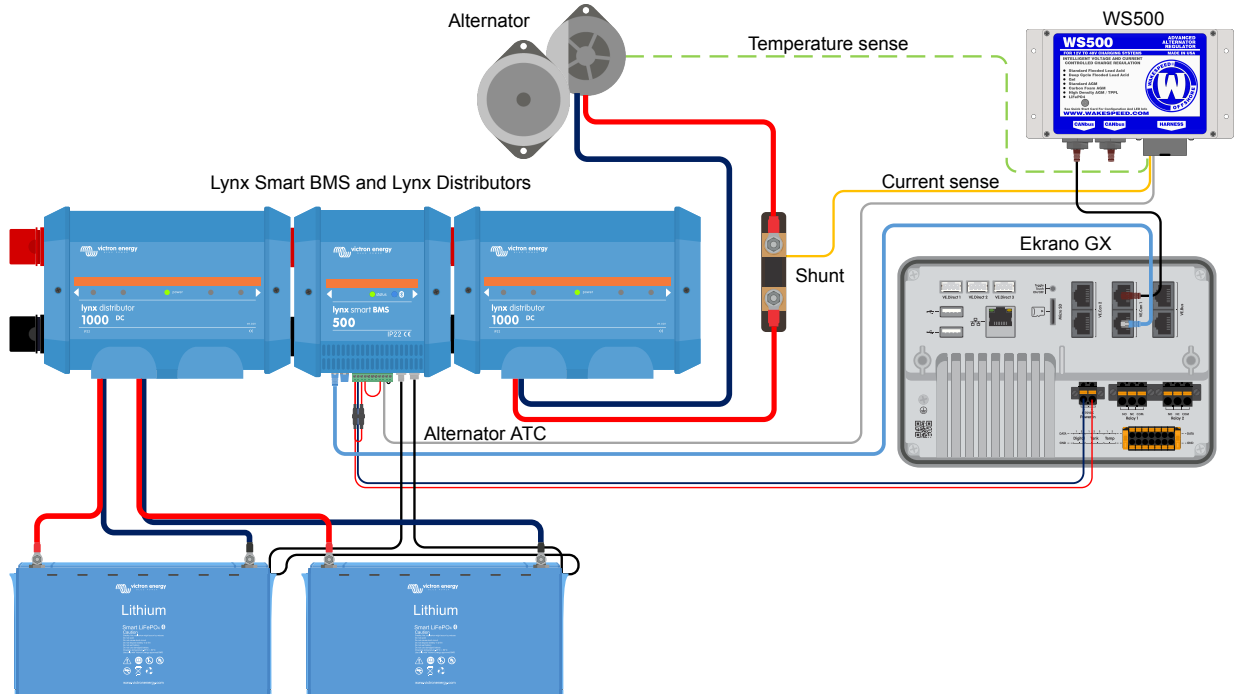

GX device user interface for WS500

Once connected, the WS500 appears in the GX device's Device List.

The WS500 menu then provides the following information and data:

- **Output:** Voltage, current, and power reported by the alternator regulator
- **Temperature:** Alternator temperature measured by the WS500 sensor
- **State:** the charging state of the WS500
 - Off: not charging
 - Bulk / Absorption / Float: WS500 active using its own algorithm
 - External Control: charging controlled by a BMS (e.g. Lynx Smart BMS)
- **Network Status:**
 - Standalone: operating independently
 - Group Master: providing charging targets to other WS500 units
 - Slave: receiving charging commands from another WS500 or BMS
- **Error:** Displays current error state
 - Refer to the Wakespeed Configuration and Communications Guide for error codes
 - See appendix for error #91 and #92
- **Field Drive:** Percentage of field drive output to the alternator
- **Speed:** Alternator RPM, derived from stator signal. If this is wrong, it can be adjusted by setting the Alt Poles option within the Wakespeed SCT configuration line
- **Engine Speed:** Engine RPM, sourced from:
 - Calculated from alternator speed and Eng/Alt ratio as set by the SCT configuration line
 - NMEA 2000 (PGN127488)
 - J1939 (PGN61444)

You may assign a custom name to the WS500 via the Device Menu. This updates the regulator's \$SCN configuration line.

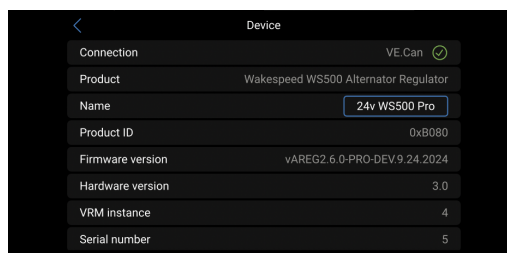
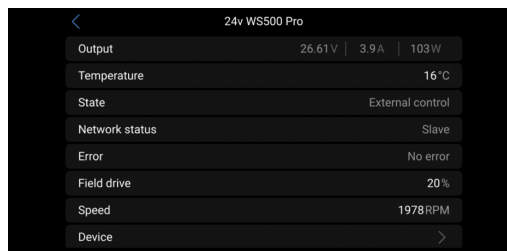
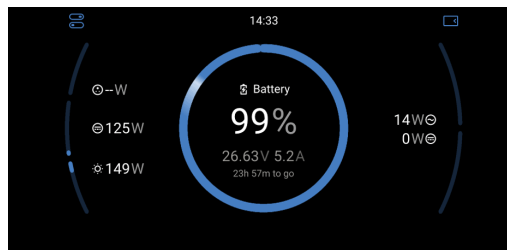

WS500 data on the VRM Portal

The [VRM portal](#) can display WS500 data including current, voltage, and temperature.

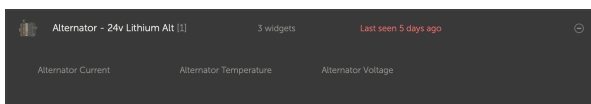

Currently 3 widgets are available on VRM

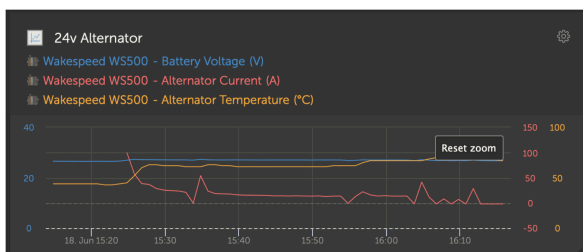

VRM custom widget showing WS500 voltage, current and temperature

Troubleshooting & FAQ

For further assistance and troubleshooting please contact Wakespeed support directly.

Error code #91 and #92

All WS500 error codes, as defined in the Wakespeed Communications and Configuration Guide, are reported by the GX device.

In systems with integrated BMS, the following errors are critical as long as the events are active and require immediate attention.

- **#91: Lost connection with BMS**

The WS500 has lost communication with the BMS and will drop into the configured get home mode. As soon as communication is restored with the BMS, it will revert to following the charging goals as set by the BMS.

- **#92: ATC disabled through feature IN**

The BMS has signalled a charge disconnect event through the feature in wire and the WS500 has therefore reverted to an Off status.

Current and power data are not displayed in the WS500 device menu

The absence of current and power data in the WS500 device menu is not a fault. It reflects the system configuration and is expected under certain conditions:

- No alternator shunt installed: The WS500 cannot measure alternator output current and power without an alternator shunt.
- Alternator shunt installed but not properly configured: Check the ShuntAtBat setting and the Ignore Sensor setting using the Wakespeed configuration tools.

Note on alternator shunt

An alternator shunt is a current sensor installed in series with the alternator output. It connects directly to the WS500 and provides real-time measurement of alternator output current and power.

- Optional: Not required for basic operation
- Mandatory: Required for DVCC compatibility
- If no shunt is installed, the GX device will still display parameters such as field drive (%) and alternator voltage, but not current or power.

FAQ

Q1: Is the alternator output current (if measured) used for anything beyond display purposes?

A1: Yes. DVCC integration allows the GX device to control the WS500's output, distributing charge current between the WS500 and, for example, MPPTs and DC-DC battery chargers.

Q2: Can the battery output current be read via CAN bus by a Lynx Smart BMS or other monitors?

A2: Yes. When the WS500 shunt is configured to measure alternator output, the current can be read over CAN bus (e.g. by a Lynx Smart BMS). The WS500 uses this to avoid overcharging, e.g. if the battery requires 100 A and the WS500 provides 200 A, the extra 100 A is directed to DC loads. This improves load calculation accuracy.

Q3: Are there wiring recommendations when using a Lynx Smart BMS or Lynx BMS NG?

A3: Yes. We provide detailed system examples, including:

- A catamaran setup with two WS500 units
- A system with a second alternator controlled by a WS500

These examples can be used as templates and are available on the [product page of the Lynx Smart BMS](#).

Q4: What if no Lynx Smart BMS is used, how should wiring be done?

A4: Wakespeed offers a quick start guide covering DIP switch configuration and harness wiring.

Additional wiring diagrams are included in the [WS500 product manual](#).

Note: the shunt must be connected to the battery, and the WS500 configured accordingly.

6.17.2. Arco Zeus Alternator Regulator support

The Arco Zeus is an external smart alternator regulator with CAN bus and NMEA 2000 communication, designed specifically for marine and RV applications. It is supported by Venus OS, including DVCC control, and enables monitoring and control of alternator performance via a GX device.

When configured correctly, the Zeus follows the charge parameters set by the GX device and/or Lynx BMS.

Requirements

To integrate the Zeus with a Victron system, the following requirements must be met:

1. Venus OS firmware v3.50 or later
2. Arco Zeus firmware v1.25 or later is installed on the Zeus controller
3. Connection via VE.Can port of the GX device. It is not possible to connect the Zeus to the BMS-Can port of a Cerbo GX.
4. Sync mode in the Zeus app must be set to 'Victron Follower'
5. An alternator shunt must be installed for proper DVCC operation. Refer to the Arco Zeus documentation.

Installation

Install the Arco Zeus regulator according to the Arco Zeus Bluetooth Alternator Regulator Installation Guide, available on the [Arcomarine website](#).

- Connect the Zeus to the VE.Can port of the GX device using a standard Cat5/6 Ethernet cable
- Ensure the VE.Can network is properly terminated:
 - Use a NMEA 2000 M12 terminator on the Zeus NMEA 2000 port.
 - Use a VE.Can RJ45 terminator on the GX device or Lynx BMS, depending on the network layout. Note: There are configurations where this is not necessary, for example, in a paralleled Lynx BMS battery system, where each battery bank has its own Zeus alternator regulator.
- Enable alternator shutoff via BMS:
 - Connect a wire from the Lynx BMS "NO" relay output to the Zeus battery/control harness input labeled "Enable/ATC from BMS"
 - This ensures the Zeus shuts off safely before the contactor opens, protecting the alternator from damage

Zeus configuration

- Refer to the Arco Zeus Bluetooth Alternator Regulator Installation Guide for full configuration instructions, available on the [Arcomarine website](#).
- In the Zeus app, set Sync Mode to "Victron Follower"
- Set the 'Alternator Max Output Current' to a value appropriate for both the alternator and the battery. DVCC uses this value to determine the maximum available charging current.

GX device configuration

On the GX device (via Remote Console):

- Navigate to Settings → Connectivity → VE.Can port [1 or 2]
- Set the CAN-bus profile to "VE.Can (250 kbit/s)"

Lynx Smart BMS or Lynx BMS NG configuration

- Set the BMS relay mode to "Alternator ATC". This ensures the ATC opens first, followed by the contactor after 2 seconds, giving the Zeus time to shut down before the battery is disconnected.

Monitoring

Once the Arco Zeus controller is connected to the GX device, it will appear in the Device List with an entry for the alternator regulator.

Available information and parameters:

- **Output:** Displays alternator output voltage, current, and power as reported by the Zeus.
- **Temperature:** Shows the alternator temperature, measured via the Zeus temperature sensor.
- **State:** Indicates the charging state of the Zeus:

- Off - Not charging
- Bulk, Absorption, or Float - When using its internal charging algorithm
- External Control – When controlled externally by a BMS, such as the Lynx Smart BMS
- **Network Status:** Displays Standalone when the regulator is operating independently.
- **Field Drive:** Indicates the percentage of field drive being applied to the alternator via the field connection.
- **Speed:** Shows the alternator speed in RPM, measured via the stator feed.
- **Engine Speed:** Displays engine RPM, determined by:
 - Calculation based on alternator speed and the engine-to-alternator drive ratio (as set in the Zeus app)
 - NMEA 2000 (PGN127488), if engine RPM is broadcast over NMEA 2000
 - J1939 (PGN61444), if engine RPM is received via J1939
- **Device:** Contains product-specific and connection-related information.

The Arco Zeus data that can be displayed on the [VRM portal](#) is current, voltage and temperature.

Troubleshooting

For further assistance and troubleshooting please contact Arco Zeus support directly.

6.17.3. Revatek Altion Alternator Regulator Support

The Revatek Altion is an external smart alternator regulator with CAN bus support for VE.Can, NMEA 2000, and RV-C protocols. Designed for marine and RV applications, it integrates with Victron GX devices to enable full alternator monitoring and control.

Supported Altion devices

- Altion
- Altion Max

Requirements

- Altion firmware v20250316 or later
- Venus OS v3.50 or later

Installation, configuration and troubleshooting

Refer to the official [Revatek Altion User Guide](#) for detailed instructions on installation, configuration, and troubleshooting. The guide is available from Revatek.

6.18. CANopen E-drive support

Venus OS provides support for Sevcon Gen4 AC, Curtis F series, and Curtis E/SE series motor controllers. This enables communication and motor drive data reporting via D-Bus to [The Boat Page \[17\]](#).



Features

- Works out of the box without requiring motor controller configuration.
- Supports Sevcon Gen4 AC, Curtis F series, and Curtis E/SE series controllers.
- Displays motor power, speed (rpm), direction, temperature, torque, and controller temperature.
- Automatically detects compatible motor controllers via CAN bus scan.
- Supports multiple controllers on the same CAN bus (each controller requires a unique CANopen node ID).

VE.Can pinout

Victron VE.Can pin number and signal
1 NC
2 NC
3 NET-C (V-)
4 NC
5 NC
6 NET-S (V+)
7 CAN-H
8 CAN-L

Motor controller pinout

Refer to the motor controller manual for the corresponding pinout.

6.18.1. How to connect the Sevcon controller to a GX device

For an overview of Victron GX devices, see: <https://www.victronenergy.com/live/venus-os:start>

CAN bus connection

Connect the CAN output of the Sevcon controller to a VE.Can port on the Victron GX device.

A modified RJ45 cable can be used.

RJ45 pin assignment:

Role	RJ45 pin number	Controller pin
CAN Ground	3 (Green/White)	B-
CAN High	7 (Brown/White)	13 or 16
CAN Low	8 (Brown)	24 or 27

Ensure all nodes on the CAN bus share a common ground.

If a node is galvanically isolated from the Gen4 controller, its CAN ground must be connected to the Gen4 controller B-.

CAN termination

For systems with multiple CAN nodes:

- Use a daisy-chain topology
- Terminate both ends of the bus with a 120 Ω resistor

If a Gen4 controller is used as an end node:

- Link pins 2 and 24 on the customer connector (120 Ω termination is built in)

For single-node systems:

- Ensure proper termination so the bus operates correctly, especially when using configuration tools

On the VE.Can side, use a VE.Can terminator if required.

Sevcon Gen4 Model support

- Tested with Sevcon Gen4 AC Size 4 controllers
- Expected to work with Size 2 and Size 6 controllers
- Gen4 DC controllers are not tested

6.18.2. How to connect a Curtis F series controller to a Victron GX device

CAN bus connection (35-pin Ampseal models)

For models with 35-pin Ampseal connectors (e.g. F6-A, F4-A), connect using one of the following CAN pin assignments:

CAN1

Role	RJ45 pin number	Controller pin
CAN Ground	3 (Green/White)	7 or 18 (non-isolated) 34 (isolated)
CAN High	7 (Brown/White)	23
CAN Low	8 (Green/White)	35

CAN2

Role	RJ45 pin number	Controller pin
CAN Ground	3 (Green/White)	7 or 18 (non-isolated) 34 (isolated)
CAN High	7 (Brown/White)	28
CAN Low	8 (Green/White)	29

If the model has isolated CAN ports:

- Connect CAN ground to pin 34 (Isolated GND)

If the model has non-isolated CAN ports:

- Connect CAN ground to pin 7 or 18

Some 35-pin models include dedicated termination resistor pins. Refer to the controller manual for details.

CAN bus connection (23-pin Ampseal models)

For models with 23-pin Ampseal connectors (e.g. F2-A):

Role	RJ45 pin number	Controller pin
CAN Ground	3 (Green/White)	12
CAN High	7 (Brown/White)	23
CAN Low	8 (Green/White)	20

These models do not have isolated CAN interfaces. Ensure the GX device shares the same ground as the controller.

Some variants include internal termination resistors. Refer to the manual to confirm.

Further model details: <https://www.curtisinstruments.com/products/motor-controllers>

Curtis F series support

- Tested with Curtis F6-A (software version 4.6.0.6)
- Expected to work with other Curtis F series controllers

6.18.3. How to connect a Curtis E/SE series controller to a Victron GX device

CAN bus connection

Use a modified RJ45 cable with the following pin assignment:

Role	RJ45 pin number	Controller pin
CAN Ground	3 (Green/White)	7
CAN High	7 (Brown/White)	23
CAN Low	8 (Brown)	35

CAN termination

To enable CAN termination on the controller:

- Connect CAN TERM H (Pin 21) and CAN TERM L (Pin 34) together

Curtis E/SE series support

- Tested with Curtis 1232 SE and 1234 E
- Expected to work with other 123X E/SE series controllers

6.18.4. How to configure the Victron GX device

Requirements

- Venus OS version 3.70 or later is required.

Configuration

1. Configure CAN bus profile

- Go to: Settings → Connectivity → <VE.Can port> → CAN-bus profile
- Select one of the following:
 - VE.Can & CANopen E-drive (250 kbit/s)
Choose this profile if the motor controller shares the same VE.Can network as other VE.Can devices.
 - CANopen E-drive (500 kbit/s)
Use this profile if the motor controller is connected to a dedicated CAN bus.

2. Scan for motor controllers

- Go to: Settings → Connectivity → <VE.Can port> → CANopen motor drives
- Ensure the following:
 - The motor controller is correctly connected to the GX device VE.Can port
 - The motor controller is powered on
- Press Scan to detect connected motor controllers.
The CANopen node IDs of detected controllers will be shown under Discovered motor drive IDs.
Detected controllers are retained after reboot or firmware update.

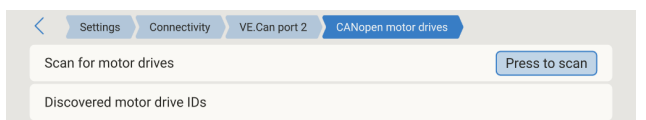
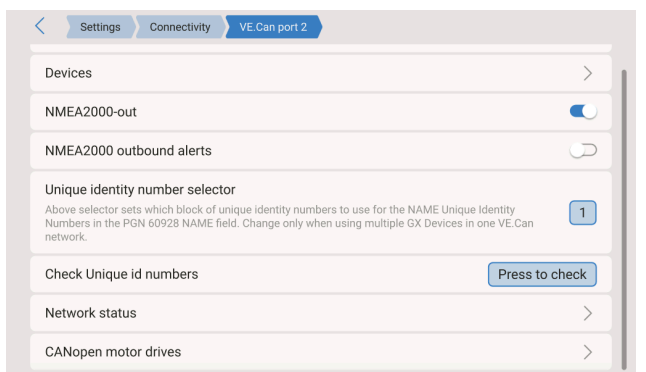
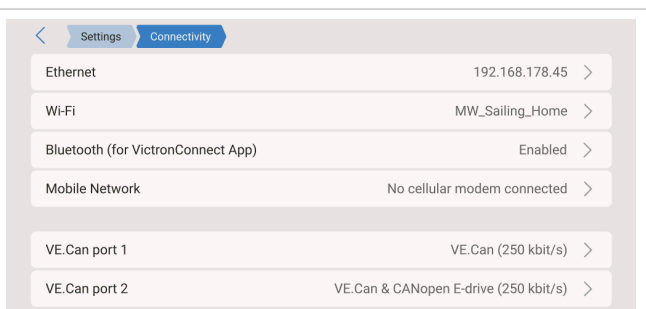

Troubleshooting

If no controllers are found:

- Verify CAN bus wiring and termination

- Verify the selected CAN-bus profile matches the controller baud rate

7. Internet connectivity

Connect the Ekrano GX to the internet to access the full functionality of the [VRM Portal](#). The EGX collects data from all connected products and sends it to the VRM Portal, where you can view the current status of connected products, configure [email alarms](#) and download data in CSV and Excel formats.

To monitor your system from a smartphone or tablet, download the VRM App for [iOS](#) or [Android](#).

In addition to remote monitoring, an active internet connection allows the EGX to regularly check for firmware updates. Depending on your settings, updates can be downloaded and installed automatically.

Note: IPv6 is supported via automatic configuration. Manual IPv6 configuration is not available.

Internet connection options

You can connect the EGX to the internet using any of the following methods:

- **Ethernet:** Connect a network cable between your router and the EGX Ethernet LAN port.
- **Built-in WiFi:** Connect wirelessly to a router using the internal WiFi module.
- **Mobile network:** Use a [GX LTE 4G - a cellular USB modem](#), or connect through a mobile router.
- **USB tethering:** Share a mobile phone's internet connection via USB.

Watch this video for guidance on connecting via LAN, WiFi, or GX GSM (also applies to GX LTE 4G):



7.1. Ethernet LAN port

When you connect an ethernet cable between a router and EGX, the Settings → Connectivity → Ethernet page of your EGX will confirm connection.



Before connecting the ethernet cable, be very careful not to confuse the GX device Ethernet port with the VE.Bus or VE.Can/BMS-Can ports!

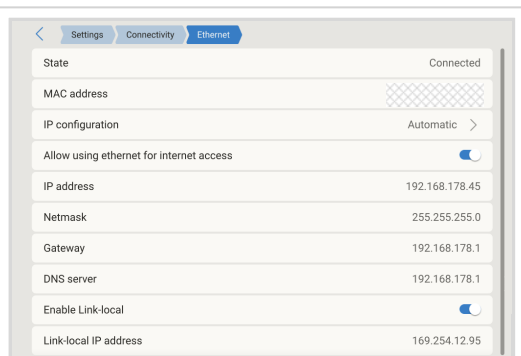

7.2. WiFi

The Ekrano GX includes built-in WiFi, supporting connections to WEP, WPA, and WPA2 secured networks. It is also possible to connect a supported external USB WiFi dongle, for example, to improve wireless range when installed inside a cabinet. Note: The built-in WiFi only supports 2.4 GHz networks. While it may detect 5 GHz networks, it cannot connect to them.

Supported USB Wifi dongles

Part Number	Model	Remarks
BPP900100200	CCGX WiFi Module Simple (Nano USB)	Compact, low cost.
BPP900200300	Asus USB-N14	Higher cost; better reception than Nano USB. Supported from software v2.23.
BPP900200400	WiFi module long range (Netgear AC1200)	Highest cost; superior reception. Supports Wireless AC, G, and N (2.4 GHz and 5 GHz).

Older, still supported dongles

Part Number	Model	Remarks
BPP900200100	Startech USB300WN2X2D	
BPP900100100	Zyxel NWD2105	
BPP900200200	Gembird WNP-UA-002	Slightly higher cost; better reception.
BPP900200400	Netgear A6210-100PES	

Although other WiFi dongles may work, they have not been tested and we do not offer support for other dongles.

WiFi network selection and behaviour

- The WiFi menu lists all available networks.
- Select a network and enter the password (if not already stored) to connect.
- WPS (WiFi Protected Setup) is not supported.
- When multiple known networks are available, the EGX automatically connects to the one with the strongest signal.
- If the connected network signal weakens significantly, it will automatically switch to a stronger known network if available.

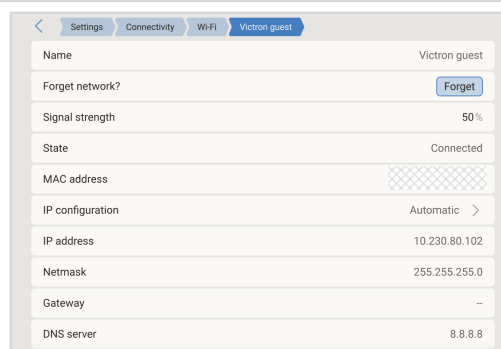

WiFi is inherently less reliable than a wired Ethernet connection. Use Ethernet wherever possible for optimal stability. If using WiFi, ensure the signal strength is at least 50% to maintain reliable operation.

7.3. GX LTE 4G

The GX LTE 4G is a cellular modem for the Victron GX range of monitoring products. It provides both a mobile internet connection for the system and connectivity to the VRM Portal. The modem is compatible with 2G, 3G, and 4G networks.

For detailed installation and configuration instructions, refer to the [GX LTE 4G Manual](#)



The GX LTE 4G provides an internet connection only for the GX device. It does not share its connection with laptops, phones, or other external devices.

7.4. Using a mobile router

When to use a mobile router

For installations where:

- Multiple devices require internet access (e.g., yachts, RVs), or
- A reliable failover/backup connection is needed,

we recommend installing a professional-grade mobile router.

A mobile router can:

- Share the cellular internet connection with multiple devices via Ethernet or WiFi.
- Switch automatically between cellular and WiFi connections if either link fails.

Connecting the EGX

To connect the EGX via a cellular network:

- Install a mobile router
- Connect the EGX to the router using either:
 - LAN (Ethernet) cable, or
 - The router's WiFi network.



Choose a router designed for unattended setups. Avoid low-cost consumer routers intended for temporary or personal use. Professional routers may be more expensive, but offer higher reliability and reduce the risk of downtime.

Example of suitable routers:

- [Proroute H685 4G LTE](#)
- [Pepwave Industrial 4G Router series](#)
- [Teltonika industrial routers](#)

Compatibility notes

The EGX does not support mobile broadband USB dongles, except for the official [GX GSM](#) and [GX LTE 4G](#) accessories available from Victron.

7.5. Manual IP configuration

In most cases, manual IP configuration is not required, as most systems support automatic IP assignment via DHCP. This is also the default setting for the EGX.

If manual IP configuration is necessary, select the appropriate template.

For full details on IP requirements and port numbers used by the GX device, refer to the [VRM FAQ - ports and connections used by the \[196\] EGX](#).

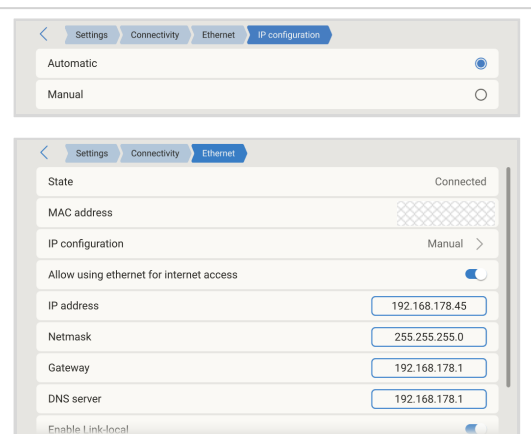

7.6. Multiple network connections (failover)

GX devices support concurrent connections to multiple network interfaces: Ethernet, WiFi, and LTE (via the GX LTE 4G accessory).

Interface priority for internet access

When more than one interface is available, the GX device will automatically prioritise them in the following order:

1. Ethernet; always preferred, regardless of WiFi or LTE availability
2. WiFi; used if Ethernet is unavailable, regardless of LTE availability
3. LTE; used only if both Ethernet and WiFi are unavailable

Internet access via Ethernet and WiFi

GX devices can be connected to both Ethernet and WiFi at the same time. Note that this setting does not apply to the LTE interface.

Each interface has an option to control whether it may be used for internet access. This applies regardless of whether the network configuration is set to Automatic (DHCP) or Manual.

- Settings → Connectivity → Ethernet → Allow using Ethernet for internet access
- Settings → Connectivity → WiFi → Allow using WiFi for internet access

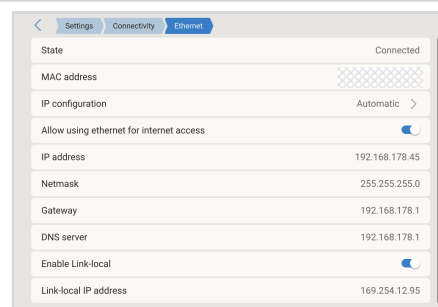

Enable the option on the interface that should provide internet access. If the option is disabled, the interface remains available for local network communication, but it will not be used for internet traffic.

Technically, disabling the option removes the default gateway from that interface. Without a default route, the interface can only communicate within its local subnet and cannot access the internet.

Important

Connection priority is based solely on network interface availability, not on whether the connection provides actual internet access. The device does not verify connectivity to the internet when selecting an interface.

7.7. Minimise internet traffic

In situations where internet traffic is costly, such as satellite connections or roaming GSM/cellular networks, you may wish to reduce the data usage.

- Disable [auto firmware updates \[102\]](#).
- Set VRM mode to read-only - see [Access settings for Remote Console & Controls pane in VRM \[125\]](#)
- Disable remote support (Settings → General → Access & Security → Remote support)
- Reduce the VRM log interval (Settings → VRM → Log interval) to the lowest acceptable frequency. Note: State changes (e.g., from charging to inverting, or from bulk to float) and alarms will still trigger additional data transmissions.

Estimating data usage

To estimate the required data allowance:

- Let the system operate normally for several days.
- Monitor the internet RX (received) and TX (transmitted) counters in your mobile router.

Alternatively, some mobile providers offer online tools to monitor data usage.

Factors affecting data consumption

- Systems with more connected products generate more traffic.
- Frequent state changes (e.g., inverter to charger transitions) increase the number of transmitted messages. This is particularly common in certain Hub-1 and Hub-2 systems.

Recommendations

- Choose a data plan with a cap or pre-paid structure to avoid expensive excess charges.
- Consider setting up automatic notifications for approaching data limits.

Advanced option: VPN traffic control

One customer, facing high international data costs, implemented a solution by routing all GX device traffic through a VPN. A firewall at the VPN server then controlled traffic based on time, connection type, location, and destination. Note that this method requires Linux and networking expertise and is beyond the scope of this manual.

7.8. More information on setting up an internet connection and VRM

For detailed instructions and further guidance, refer to:

- [Setting up a VRM account](#)
- [VRM Portal alarms and monitoring](#)
- [VRM Portal - Frequently asked questions](#)

8. Accessing the GX device

The GX device can be accessed using a smartphone, tablet, or computer via the Remote Console. This is the main interface for configuring and monitoring the GX device.

Access methods by device type

Access type	Venus GX	Cerbo GX / Cerbo-S GX	Ekran GX
VictronConnect via Bluetooth ^[3]	- [1]	Yes	Yes
Built-in WiFi Access Point [84]	Yes	Yes	Yes
Local LAN/WiFi network [85]	Yes	Yes	Yes
VRM Portal [2]	Yes	Yes	Yes

^[1] The VGX does not have built-in Bluetooth. Add Bluetooth support using a USB Bluetooth dongle.

^[2] VRM access requires the GX device to be connected to the internet.

^[3] Bluetooth is limited to initial setup and network configuration only. It cannot be used to access Remote Console or connect to other Victron products (e.g. SmartSolar chargers). For connecting to other Victron products, see [Connecting Victron products](#) [25].

8.1. Using VictronConnect via Bluetooth

If you're just getting started with VictronConnect, we recommend reading the [VictronConnect manual](#) for a full overview.

1. Download the [latest version of the VictronConnect app](#) to your [Bluetooth compatible device](#) (mobile phone, tablet, or laptop - Windows PCs are not supported), and ensure Bluetooth is enabled.
2. Ensure the Ekran0 GX is powered on.
3. Open the VictronConnect app within 10 meters of the Ekran0 GX and wait for nearby devices to be discovered.
4. Once discovered, click or tap on the Ekran0 GX.
5. On first connection, you will be prompted to enter a Bluetooth PIN code.
The unique PIN code is printed on a sticker on the topside of the Ekran0 GX.
6. If your device uses the default PIN, you will be asked to change it to a more secure, unique code. Be sure to store your new PIN code in a secure place.

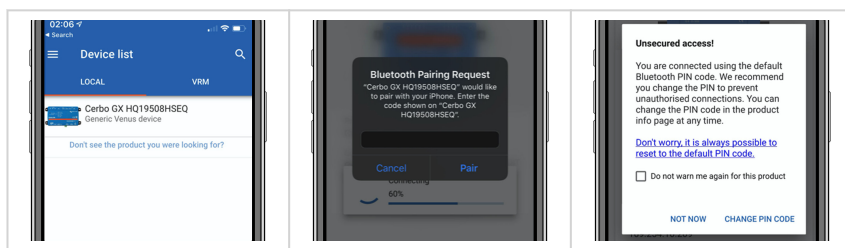

From the main device screen in VictronConnect, you can:

- Change network and Ethernet settings
- Enable or disable the built-in WiFi Access Point
- Access your system on VRM
- Open the Remote Console (requires connection to a local WiFi network or the device's WiFi AP)

To access network settings, tap the cogwheel icon.

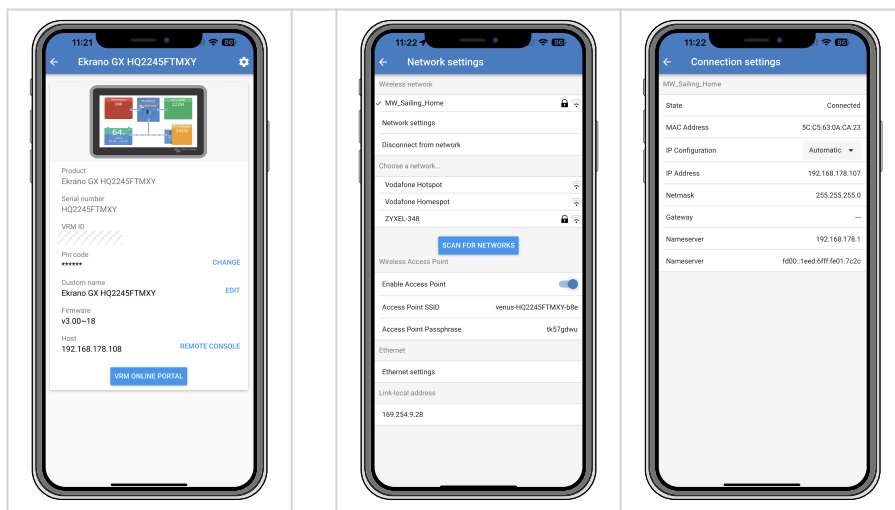

Limitations

Bluetooth is only used for initial connection and basic networking setup. It cannot be used to connect to other Victron products (e.g. SmartSolar charge controllers). To connect to other Victron products, refer to the [Connecting Victron products \[25\]](#) chapter.

8.2. Accessing via built-in WiFi Access Point

This method requires the VictronConnect app to be installed on your smartphone, tablet, or laptop.

Steps to connect automatically via the QR Code:

1. Locate the QR code sticker on the side of the EGX
2. Scan the QR code using your phone's camera function, or a QR code scanning app
3. If supported by your phone, this will prompt you to connect you to the WiFi Access point
4. Once connected, open VictronConnect
5. Select the GX device from the list
6. Open the Remote Console

Steps to manually connect:

1. Stand close to the Ekran GX, no further than a few meters away.
2. Open the WiFi settings on your phone, tablet, or laptop.
3. Look for a network name like Venus-[serial_number-xxx].
4. Connect using the WiFi key, printed both on the side of the box and on a card included in the plastic bag. Keep this key stored securely.
5. Launch VictronConnect, which will start scanning the WiFi network automatically.
6. Once found, select the GX device from the list.
7. Open the Remote Console

Notes

- If you cannot use VictronConnect, you can use a web browser and navigate to the IP address <http://172.24.24.1> or <http://venus.local>
- For additional security, the WiFi Access Point can be disabled: Navigate to Settings → Connectivity → Wi-Fi → Create access point in the Remote Console.

Instruction video

Watch the step-by-step instruction video on how to connect to a GX device using the VictronConnect app:

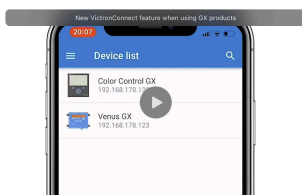

8.3. Accessing the Remote Console via local LAN/WiFi Network

This section explains how to access the Remote Console when the GX device is connected to a local network via Ethernet or a configured WiFi connection.

□ An internet connection is not required, only a working local network.

Once connected, connect to the GX device by running the [VictronConnect app](#) on a phone, tablet or laptop. Alternatively, you can also connect to the GX device via a web browser by entering `venus.local` in the address bar.

Note that it will need to be connected to the same computer network as the Ekrano GX.

This video shows how it is done.



8.3.1. Alternative methods to find the IP address for Remote Console

If VictronConnect cannot be used, the following methods can help you find the IP address of the Ekrano GX for Remote Console access:

Link Local Address - `venus.local`

You can access the GX device by entering `venus.local` or `http://venus.local` in a web browser, provided your computer is connected to the same local network.

IP Address via VRM Portal

If the GX device is connected to the internet and registered on the VRM Portal, you can find its IP address:

- Go to the Device list on your installation page
- The IP address will be listed there

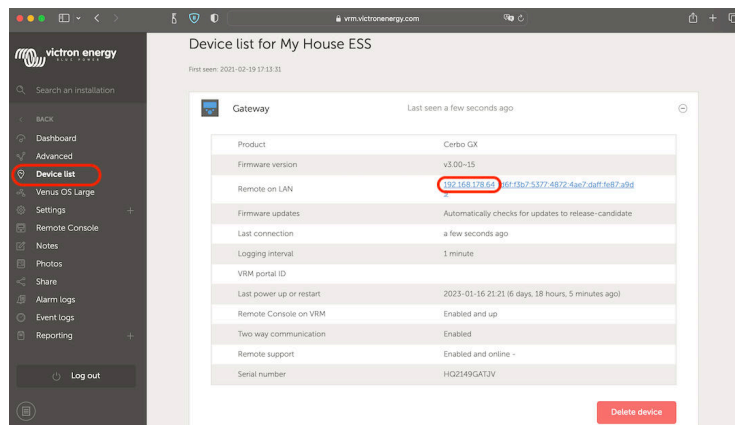

Local Network Discovery (Windows only)

If you are on the same local network (e.g. at home), and using Microsoft Windows, you can locate the GX device using Network Discovery (UPnP):

Open File Explorer and navigate to the Network section

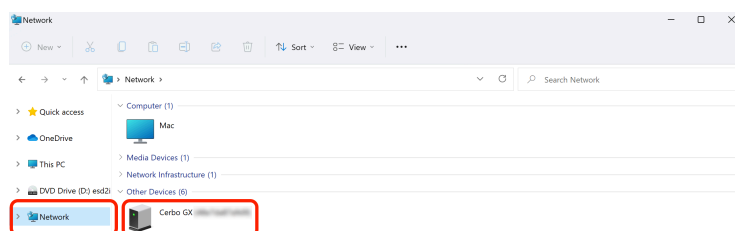

Double-clicking the GX device icon will open up Remote Console on LAN.

To view the IP address: Right-click the icon → Properties

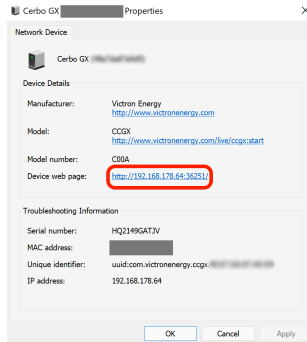

8.4. Accessing via VRM

This method requires an active internet connection for both the GX device and the phone, tablet, or computer accessing it. For a new installation, connect the GX device to the internet using an Ethernet cable.

Step-by-step instructions:

1. Connect the GX device to the internet
Plug it into a network with DHCP enabled (most routers support this) and internet access.
2. The device will automatically connect to the VRM Portal.
3. Log in to the VRM Portal (<https://vrn.victronenergy.com/>) and follow the prompts to add the GX device.
4. Once the device is visible in VRM, click Remote Console in the left-hand menu.
5. The Remote Console window will open and look similar to the image on the right.

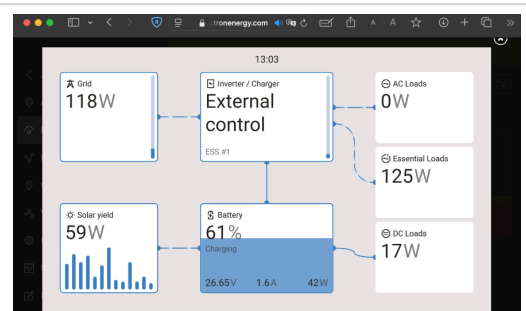

For more technical details and troubleshooting, see: [Remote Console on VRM - Troubleshooting \[126\]](#).

9. Configuration

9.1. Menu structure and configurable parameters

After completing the installation and setting up the internet connection (if required), go through the menu from top to bottom to configure the GX device as needed.

The menu structure is divided into 6 main categories:

- Devices: All connected devices
- General: Access control, Display, Firmware, Support
- Connectivity: Ethernet, Wi-Fi, Bluetooth, VE.Can
- VRM: Remote monitoring portal
- Integrations: Relays, Sensors, Tanks, PV, Inverters, Modbus, MQTT...
- System Setup: AC/DC system, ESS, DVCC, Battery...

Item	Default	Description
Settings - The main menu.		
Settings → Devices		
Various	Various	Lists all devices connected to the GX. Most entries include submenus with further details and configuration options.
Settings → General		
Settings → General → Firmware		
Firmware - Read full feature description [102]		
Firmware version	x.xx	Shows the installed firmware version.
Build date/time		Shows build date and time.
Image type	Normal	Shows the image type (Normal or Large).
Online updates		Submenu for online update control.
Online updates: Auto update	Check only	Checks for new versions. Options: Disabled, Check only, Check and update.
Online updates: Update feed	Official release	Options: Official release, Beta release.
Image type	Normal	Normal or Large image. Large adds Node-RED and Signal K server.
Online updates: Check for updates	Press to check	Manual check for updates.
Online updates: Update available	Press to update	Shown when updates are available.
Install firmware from SD/USB		Use this menu to install a new version from a microSD card or USB stick. Insert the card or stick that holds the new firmware .swu file.
Stored backup firmware		Submenu for switching between the current and previously installed firmware version.
 Note that for most system applications our advise is to keep automatic updates disabled; as is also the default factory setting. Instead, update the system at a convenient moment; when people are on location and ready to revert to a previous system and/or troubleshoot in case of issues.		
Settings → General → Access & Security		
Access level	User and User & Installer	Set this to 'User' to prevent accidental and unwanted changes to the configuration. User & Installer has additional privileges and once changed from default requires a password. Password is available from your dealer.

Item	Default	Description
Local network security profile	Secured	Secured = Password protection and network communication encryption. A password must be set. Weak = Password protection but no network communication encryption. A password must be set. Unsecured = No password protection and no network communication encryption
Remote support	Disabled	Enable this to allow Victron engineers to access your system in case there is a problem.
Remote support tunnel	Offline	Displays 'Online' when 'Remote support' is enabled.
Remote support IP and port	[IP;port]	Displays the remote support IP address and port.
Settings → General → Display & Appearance		
Adaptive brightness	Enabled	Allows to switch adaptive brightness off. Only for GX Touch displays and Ekrano GX.
Display off time	10s	Allows to set the display off time between 10s and 30 minutes, or never.
GX display appearance	Light	Allows to toggle between light and dark mode.
Remote Console appearance	Auto	Options are Same as GX display or Auto.
Start page	Brief page	Submenu to set the start page and define a timeout for reverting to it.
Brief page		Submenu to adjust the level of detail shown in gauges, tank information, and centre widgets.
Boat page	Disabled	Enables or disables the Boat page. When dual E-Drive controllers are connected, additional information and configuration options become available.
Data units		Submenu to set the units for temperature, volume, electrical power, and GPS.
Minimum and maximum gauge ranges		Submenu to set fixed min/max ranges for AC/DC gauges and graphs, or enable auto-ranging.
UI Animations	Disabled	Switch to turn off UI animations to reduce CPU usage.
User interface	New UI	Submenu to switch between the new and classic user interface.
Settings → General → Alarms & Feedback		
Alarms & Feedback	Enabled	When an alarm occurs on the GX device or a connected product, the device will emit a beep, unless this setting is set to disabled.
Settings → General → Language		
Language	English	Submenu to select the user interface language.
Settings → General → Date & Time		
Date & Time		Select your local time zone. The time is then adjusted automatically.
Settings → General → Reboot		
Reboot	Reboot Now	Reboots the GX device.
Settings → General → Documentation		
Documentation		Submenu with links to product support, the Victron Community, and Where to buy option.
Settings → General → Support status		
Support status (modification checks)		Submenu showing if the GX device is in standard or modified state, with an option to restore official firmware to fix the modified state.
Settings → General → Demo mode		

Item	Default	Description
Demo mode	Disabled	Activates a simulation mode to demonstrate product and system features for clients or exhibitions. It allows users to explore the interface without altering real settings. Note: Enabling demo mode adds simulated devices to the VRM installation. Available demos include ESS, Boat, and Motorhome.
Settings → Connectivity		
Settings → Connectivity → Ethernet - Read full feature description [77]		
State	Unplugged	Indicates the current connection status of the device: Unplugged, Connecting, or Connected.
MAC address		Displays the unique hardware address of the network interface. Used for network identification and troubleshooting.
IP configuration	Automatic	Options: Automatic (DHCP) and manual IP address allocation
Allow using ethernet for internet access	Disabled	Use this feature to allow the GX using the connection for internet access.
IP address		Shows the current IP address assigned to the device for network communication.
Netmask		Displays the subnet mask used to define the local network range.
Gateway		Displays the IP address of the network gateway used to access external networks, such as the internet.
DNS server		Displays the IP address of the DNS (Domain Name System) server used to resolve domain names into IP addresses.
Enable Link-local	Disabled	Option to enable the link-local interface.
Link-local IP address		Displays the automatically assigned IP address used for local network communication when no DHCP server is available. Typically in the 169.254.x.x range.
Settings → Connectivity → Wi-Fi - Read full feature description [78]		
Create access point	Enabled	Enables or disables the internal WiFi access point of the GX device. Disabling it turns off the device's ability to broadcast its own network.
Access Point password		Connect using the WiFi key, printed both on the side of the box and on a card included in the plastic bag. A custom access point password can also be set if required.
Allow using WiFi for internet access	Disabled	Use this feature to allow the GX using the connection for internet access.
Wi-Fi networks		Displays the list of available WiFi networks and the network currently connected to the GX device, if any.
Name	Connected	Displays the SSID (network name) of the connected or selected WiFi network.
Forget network	Forget	Press to remove the saved WiFi network configuration. Use this when switching to a different network or troubleshooting connection issues.
Signal strength	%	Displays the WiFi signal strength as a percentage (%), indicating the quality of the wireless connection.
State		Indicates the current WiFi connection status of the GX device. Possible values: Connected, Connecting, or Disconnected.
Mac address		Displays the unique hardware address of the network interface. Used for network identification and troubleshooting.
IP configuration	Automatic	Choose between Automatic (DHCP) and Manual IP address configuration.
IP address		Shows the current IP address assigned to the device for network communication.
Netmask		Displays the subnet mask used to define the local network range.
Gateway		Displays the IP address of the network gateway used to access external networks, such as the internet.

Item	Default	Description
DNS server		Displays the IP address of the DNS (Domain Name System) server used to resolve domain names into IP addresses.
Settings → Connectivity → Bluetooth (for VictronConnect App)		
Bluetooth (for VictronConnect App)	Enabled	Switch to enable or disable the built-in Bluetooth interface. Pincode: For GX devices with serial numbers before HQ2242, the default PIN is 000000. For HQ2242 or later, a random 6-digit PIN is printed on the label on the back of the device.
Settings → Connectivity → Mobile Network		
Mobile Network	No cellular modem connected	Submenu with options to configure a connected GX GSM or GX LTE 4G modem. Read full feature description.
Settings → Connectivity → VE.Can port		
VE.Can port 1..2 (if applicable)	VE.Can (250 kbit/s)	Submenu to configure the CAN-bus profile for the VE.Can port(s). Available options include: Disabled, VE.Can (250 kbit/s), VE.Can & CAN-bus BMS (250 kbit/s), VE.Can & CANopen E-drive (250 kbit/s), CAN-bus BMS LV (500 kbit/s), Oceanvolt (250 kbit/s), RV-C (250 kbit/s), CANopen E-drive (500 kbit/s). Additional options include: Devices, NMEA2000-out, Unique Identity Number Selector, Check Unique ID Numbers, and Network Status.
Settings → VRM - Read full feature description [120]		
VRM Portal	Full	This setting determines the system's connection to the VRM portal: <ul style="list-style-type: none"> Off – No connection to VRM Read-only – Allows monitoring but no remote setting changes or firmware updates Full – Enables full remote access and management
VRM Portal ID		Use this ID string when registering the GX device on the VRM Portal.
VRM Device Registration		Contains a link and/or QR code for device registration on the VRM Portal.
VRM device instances		Provides the device instances for every device connected to the GX.
Log interval	15 minutes	Set the interval between data logs to any value from 1 minute to 1 day. For systems with unstable connections, a longer interval is recommended.
Use secure connection (HTTPS)	15 minutes	Encrypts communication between the GX device and the VRM server using HTTPS for secure data transmission.
Last contact		Displays the time elapsed since the GX device last communicated with the VRM server.
Connection status	No error	Shows the current status of the VRM connection. If there is a communication error, it will be displayed here. See here for more details on troubleshooting VRM errors. [122]
Reboot device when no contact	Disabled	When enabled, the GX device will automatically reboot after a set delay if the internet connection is lost. This can help resolve temporary networking issues.
No contact reset delay (hh:mm)	01:00	Defines how long the GX device must be offline before it automatically restarts to restore connectivity.
Storage location	Internal storage	Indicates whether data is being stored on the internal memory or an external device such as a USB drive or microSD card, if mounted.
Free disk space		Displays the amount of available storage space on the current storage device.
microSD / USB		Use this option to safely eject a connected microSD card or USB storage device before removal. Removing it without ejecting may result in data loss.

Item	Default	Description
Stored records		Displays the number of data records stored locally while the device is offline. The GX device will upload these records automatically once the internet connection is restored.
Oldest record age		Indicates how old the oldest locally stored record is, in cases where the GX device has been unable to connect to the internet or VRM.
Settings → Integrations → PV Inverters - Read full feature description		
Inverters		Displays connected AC PV inverters.
Inv: Position	AC Input 1	AC input 1, AC input 2, AC Output
Inv: Phase	L1	
Inv: Show	Yes	
Find PV inverters		Scan for available PV inverters.
Detected IP addresses		Displays the IP address of PV inverters that have been discovered.
Add IP address manually		If an inverter has a manually assigned IP address, you can add it directly here.
Automatic scanning		This setting will continue to look for PV inverters, this can be useful if using a DHCP assigned IP address that might change.
Settings → Integrations → Energy Meters via RS485 - Read full feature description		
Role	Grid meter	Define the role of the energy meter. Available options: Grid, PV inverter, Generator, AC load, EV Charger, Heat pump
Phase type	Single phase	Select the phase type of the system to be measured: either single-phase or multi-phase.
Settings → Integrations → Modbus Devices		
Automatic scanning	Enabled	Scans automatically for Modbus TCP/UDP devices.
Scan for devices	Press to scan	Manually trigger a scan for Modbus TCP/UDP devices.
Saved devices		Displays a list of found Modbus TCP/UDP devices and their IP address.
Discovered devices		Displays a list of discovered Modbus TCP/UDP devices. Use this menu to activate these devices.
Settings → Integrations → Bluetooth Sensors		
Enable	Disabled	Enable this option to scan for supported Bluetooth sensors. Enable to scan for supported Bluetooth sensors. Discovered sensors are listed with a slider to activate them.
Continuous scanning	Disabled	Forces continuous scanning for supported Bluetooth sensors. May interfere with WiFi operation.
Bluetooth adapters		Lists built-in and connected Bluetooth adapters with their MAC addresses.
Settings → Integrations → Tank and Temperature Sensors		
Tank level input (number depends on device)	Disabled	Enable to display the tank level inputs in the Devices list.
Temperature input (number depends on device)	Disabled	Enable to display the temperature inputs in the Devices list.
Settings → Integrations → Relays		
Function (Relay #)	Alarm relay	Selects the function assigned to the relay. Available options include: Disabled, Alarm relay, Genset start/stop, Connected genset helper relay, Tank pump, Temperature, and Manual. When the relay is set to manual mode, a slider is displayed that allows you to turn the relay on or off manually.
Polarity (Relay #)	Normally open	Sets the relay polarity on the back of the GX device. Options are Normally open or Normally closed. Note: Using Normally closed increases the power consumption of the GX device.

Item	Default	Description
Settings → Integrations → Digital I/O		
GX Built-in - Digital input #	Disabled	Controls the function of digital inputs. Available options include: Disabled, Door alarm, Bilge pump, Bilge alarm, Burglar alarm, Smoke alarm, Fire alarm, CO ₂ alarm, and Generator. On specific GX devices, additional options such as Touch input control and Pulse meter are also available.
Settings → Integrations → MQTT Access		
MQTT Access	Disabled	MQTT access only needs to be enabled when integrating a third party device or service like Home Assistant which requires access to the MQTT broker over the local network.
Settings → Integrations → Modbus TCP Server		
Modbus TCP Server		Submenu to enable Modbus TCP and grant access permissions.
Enable Modbus TCP Server	Disabled	This setting enables the ModbusTCP service. More information about ModbusTCP in this document and in the communications white paper https://www.victronenergy.com/upload/documents/Whitepaper-Data-communication-with-Victron-Energy-products_EN.pdf
Access permissions	Write allowed	Defines whether Modbus clients have read-only access or are also allowed to write values.
Available services		Lists all available services together with their Unit ID.
Settings → Integrations → Venus OS Large Features		
Signal K		Enable to start the integrated Signal K server.
Node-RED		Enable to start the integrated Node-RED environment.
Venus OS Large Documentation		Link to the Venus OS Large documentation.
Victron Community		Link to the Victron Community.
Settings → System Setup		
Settings → System Setup → System name		
System name	Automatic	Select the system name - presets or user defined.
Settings → System Setup → AC System		
AC input 1	Generator	Select Not available, Generator, Grid or Shore power. Note: additional configuration is required for complete setup of these options.
AC input 2	Grid	Same choices as above.
Position of AC loads	AC output only	Options: <ul style="list-style-type: none"> AC input only – The AC output of the Inverter/Charger is not used. AC output only – All AC loads are connected to the output of the Inverter/Charger. AC input & output – The system automatically displays loads on the input of the Inverter/Charger if a grid meter is present. Loads on the output are always displayed.
Monitor for grid failure	Disabled	Monitors for loss of AC-input and triggers an alarm if detected. Alarm is cleared when the AC-input is reconnected.
Settings → System Setup → ESS - Read full feature description.		
Mode	Optimized with BatteryLife	Options: Optimized with BatteryLife, Optimized without BatteryLife, Keep batteries charged, External control
Grid metering	Inverter/charger	Leave this setting at Inverter/charger if no external grid meter is used. Set to External meter when using a supported external energy meter.
Self-consumption from battery	All system loads	This setting allows for ESS to only use battery power for essential loads. Options are 'All system loads' or 'Only critical loads'.

Item	Default	Description
Multiphase regulation	Total of all phases	Use this setting in three-phase grid-connected systems. It enables phase compensation to help balance power flow across all phases.
Minimum SOC (unless grid fails)	10%	Configurable minimum SoC limit. ESS will supply loads from the grid once the SoC has fallen to the configured setting - except when the utility grid has failed and the system is in Inverter mode.
Active SOC limit	10%	Use this setting to see the current BatteryLife SoC level. Only in 'Optimized with BatteryLife' mode.
BatteryLife state	Self-Consumption	Displays the BatteryLife state, which can be one of the following: Self-consumption, Discharge disabled, Slow charge, Sustain, or Recharge. Only in 'Optimized with BatteryLife' mode.
Limit inverter power	Disabled	Limit the power drawn by the Multi: ie. limit the power being inverted from DC to AC.
Grid set point	50W	Defines the target power flow to the grid. A higher setpoint provides a buffer to help prevent unintentional energy export during sudden load changes.
Grid feed-in		Configure and limit the amount of power fed into the grid. Options include: AC-coupled PV - feed in excess, DC-coupled PV - feed in excess, Limit system feed-in. Also displays whether feed-in limiting is currently active.
Peak shaving	Above minimum SoC only	Above minimum SoC only, or Always. Also includes a submenu to manually set the system AC import and export current limits per phase.
Scheduled charge levels	Inactive	Allows configuration of up to five time periods during which the system will charge the battery using power from the grid.
Settings → System Setup → Batteries		
Battery monitor	Automatic	Select the SoC source. This function is useful where there is more than one source of battery. Options: Automatic, No battery monitor and available battery monitor sources. For more details see Battery state of charge (SoC) [97] .
Auto-selected		Displays the automatically selected SoC source when the 'Battery monitor' is set to 'Automatic'.
[Battery]		Provides live data and a quick link to the individual battery page. Only available if Battery measurement is set to visible.
Battery measurements		Use this menu to define the battery data shown when clicking the Battery icon on the Overview page. The same selection is also visible on the VRM Porta.
Settings → System Setup → Charge Control - Read full feature description [111]		
DVCC	Disabled	Enabling DVCC turns the GX device from a passive monitor into an active controller. By default, it is disabled unless a compatible BMS-Can managed battery is connected, in which case it is set and locked according to the manufacturer's specifications.
Limit charge current	Disabled	Sets a user-defined maximum charge current for the entire system, specified in Amps. This allows coordinated charge control across all supported devices.
Limit managed battery charge voltage	Disabled	This option is intended only for initial balancing of 15s Pylontech batteries. Do not use it for other purposes, as it may lead to undesirable side effects.
SVS - Shared voltage sense	Disabled	When enabled, the GX device automatically selects the best available voltage measurement and shares it with other connected devices.
STS - Shared temperature sense	Disabled	When enabled, the GX device transmits the measured battery temperature to the inverter/charger system and all connected solar chargers.

Item	Default	Description
Temperature sensor	Automatic	Select which temperature sensor is used for Shared Temperature Sense. In automatic mode, the GX device chooses the most suitable available sensor.
SCS - Shared current sense	No	When enabled, the GX device forwards the battery current measured by a connected battery monitor to all supported solar chargers for coordinated charging behaviour.
SCS status		Displays if SCS is enabled, or why it is disabled.
Controlling BMS	Automatic	Selects which Battery Management System (BMS) is used to control the battery, or disable BMS control. In automatic mode, the GX device chooses the appropriate BMS based on the system configuration.
Auto selected		Displays the BMS currently selected by the system when 'Controlling BMS' is set to 'Automatic'.
Settings → System Setup → Display DC Loads		
Display DC Loads	Disabled	<p>Enable this for boats, vehicles and installations with DC loads and chargers - in addition to Multi and MPPT chargers. This won't be applicable to most off-grid installations; and any discrepancy between the DC current measured by the Multi, and by the BMV, will be attributed to a 'DC system'. This may be power-in from an alternator, or power-out from a pump, for example.</p> <p>A positive value indicates consumption. A negative value indicates charging, for example by an alternator.</p> <p>Note that the value shown will always be an approximation, and is affected by the variation in sample rate between elements of the system. To replace the approximated values with accurate measurements, a SmartShunt can be used, which needs to be configured to Monitor mode "DC Energy Meter" and DC meter type "DC System".</p>
Wireless AC sensors (if applicable)		
Select the position for each AC sensor (PV Inverter on AC-input 1, 2 or on AC-output). More information about the Wireless AC sensors.		
Settings → Devices → GPS - Read full feature description [37]		
GPS information	-	Displays GPS data including: Status, Latitude, Longitude, Speed, Course, Altitude, and Number of satellites in view.
Device	-	Displays device related information for diagnostic.
Settings → Devices → Genset - Read full feature description [165]		
Autostart functionality	Disabled	Enable or disable the generator's Autostart feature. Further configuration is available under Genset → Settings → Conditions.
Manual control	-	Allows manual generator operation for a specified duration.
State	Not running	Shows the state of the generator. Possible state messages: Stopped, Warm-up, Manually started, Running by condition, Cool-down, Stopping
Error	#0 No error	Displays if there is an error (e.g. generator is supposed to be running but no AC input is detected)
Settings		Contains submenus for further configuration, such as Conditions, Warm-up & Cool-down, and Quiet Hours. Also includes a switch to enable an alarm if the generator is not in Autostart mode.
Run time and service		Displays the total generator runtime, daily runtime, time remaining until the next service, and the configured service interval. Includes options to reset both the service timer and the daily runtime counter.
Settings → Devices → Genset → Settings → Conditions		
On loss of communication	Stop generator	Defines what the system should do if communication with the GX device is lost. Options: Stop generator, Start generator, Keep generator running.

Item	Default	Description
Stop generator when AC input is available	Disabled	Useful for backup systems where a Quattro is connected to mains on one AC input and a generator on the other. When enabled, the generator will stop automatically once mains power becomes available again.
Battery SOC	Disabled	Use the battery state of charge (SoC) to control generator start and stop behaviour. Enable to activate. Start when SoC is lower than the defined percentage. A separate start value can be set for quiet hours to override them if necessary. Start after the SOC condition is reached for [seconds]. Stop when SoC is higher than the defined percentage. A separate stop value for quiet hours can be set to minimise runtime once the system has stabilised. A separate stop value can be set for quiet hours to override them if necessary.
Battery current Battery voltage AC load	Disabled	Use any of the parameters to control generator start and stop behaviour. Enable to activate. Start when value is higher than - Amps / Voltage / Watts Start value during quiet hours - Amps / Voltage / Watts (to override programmed quiet hours when absolutely necessary). Start after condition is reached for [seconds] (to allow for momentary spikes to pass without triggering start). Stop when value is lower than - Amps / Voltage / Watts. Stop value during quiet hours - Amps / Voltage / Watts (allows for less runtime during quiet hours, once system is recovered). Stop after the condition is reached for [seconds] (to allow for momentary dips without stopping the running generator).
Inverter high temperature Inverter overload	Disabled	Use inverter high temperature warning or inverter overload warning to control generator start and stop behaviour. Enable to activate. Start when warning is active for [seconds] (to allow for momentary spikes to pass without triggering start). When warning is cleared stop after [seconds] (to allow for momentary dips without stopping the running generator). On inverter overload warning it also allows to skip generator warm-up.
Tank level	Disabled	Use the tank level to control generator start and stop behaviour. Enable to activate. Stop when Tank level is lower than threshold. Prevent start until Tank level is higher than threshold. Trigger warning when the generator is stopped.
Periodic run	Disabled	Enable - No / Yes Run interval [days] Skip run if has been running for: Start always, 1, 2, 4, 6, 8, 10 hours. Run interval start [date] Start time [hh:mm] Run duration (hh:mm) Run until battery is fully charged. Default is disabled.
Settings → Devices → Genset → Settings		
Conditions		Submenu - see above.
Minimum run time	0m	Defines a minimum run time in minutes.
Detect generator at AC input	Disabled	When enabled, the system will trigger an alarm if no power from the generator is detected at the selected inverter AC input. Ensure that the correct AC input is assigned to "Generator" in the system setup.

Item	Default	Description
Alarm when generator is not in autostart mode	Disabled	When enabled, an alarm will trigger if the autostart function remains disabled for more than 10 minutes.
Quiet hours	Disabled	Quiet hours will prevent normal generator run conditions from starting the generator. It is possible for some settings to specify override values to the quiet hours (an extremely low battery voltage trigger to prevent a system shutdown for example).
Warm-up & cool-down		
Warm-up time	60	Sets the delay time for generator warm-up via relay control before it is connected to the system. During this time, the AC input relay remains open and the inverter/charger is not yet connected.
Cool-down time	180	Sets the delay time after the generator is disconnected from the system, allowing it to cool down before shutting off. The AC input relay remains open during this period.
Generator stop time	0	
Settings → Devices → Genset → Run time and service		
Generator total run time (hours)	Hours	Displays the total number of hours the generator has operated.
Daily run time		Submenu displaying the daily run time for the last 30 days.
Reset daily run time counters		Provides an option to reset the generator's run time counters. This is useful after generator replacement, major repairs, or when the counters are used for service tracking.
Runtime until service	Hours	Displays the remaining run time before the next scheduled service. Enter the desired service interval in hours.
Generator service interval	Hours	Sets the generator service interval in hours. Determines how often maintenance is required based on run time. If not set, the Runtime until service item is hidden.
Reset service timer		Press to reset the service timer after the service is complete.
Settings → Devices → Tank pump - Configure automatic pump start/stop based on tank level (sender) information.		
Pump state	-	Indicates whether the pump is currently running or stopped.
Mode	Auto	Defines the pump control mode. Options are Auto, On, and Off. This acts as a manual override when a tank sensor is connected and start/stop levels are defined.
Tank Sensor	No tank sensor	Select the tank sensor used to trigger the pump. If no sensor is connected or detected, "No tank sensor" will be shown.
Start level	50%	Defines the tank level at which the pump will start (relay closes). When the measured level falls below this value, the pump is activated.
Stop level	80%	Defines the tank level at which the pump will stop (relay opens). When the measured level rises above this value, the pump is deactivated.

9.2. Battery state of charge (SoC)

9.2.1. Which device should I use for SoC calculation?

The GX device does not calculate State of Charge (SoC); it simply displays SoC values received from other devices.

There are three product types that can calculate SoC:

1. Battery Monitors, such as the BMVs, SmartShunt, Lynx Shunt VE.Can, Lynx Smart BMS or the Lynx Ion BMS
2. Multi and Quattro inverter/chargers
3. Batteries with a built-in battery monitor, typically connected via BMS-Can (e.g. BYD, Freedom Won)

When to use which?

- **Battery with built-in monitor (e.g. BYD, Freedom Won):** → Use the battery's SoC. This is the most accurate and preferred source.
- **Inverter/charger-only systems:** → If the Multi or Quattro is the sole source of charging and discharging, it can reliably calculate SoC, no external battery monitor needed.
- **Systems with inverter/charger, MPPTs with GX device communication:** → Still no need for a separate battery monitor, as the GX device aggregates data from the Victron components for accurate SoC. However, the accuracy of the SOC is improved if a dedicated battery monitor (e.g. BMV, SmartShunt, Lynx Shunt) is installed.
- **All other systems (e.g. boats, RVs with DC lights, additional DC loads/chargers):** A dedicated battery monitor is required (e.g. BMV, SmartShunt, or Lynx Shunt VE.Can) to ensure accurate SoC tracking.

9.2.2. Notes on SoC

The State of Charge (SoC) is primarily used to inform the user and is not essential for system operation or charging behaviour.

△ SoC is not used for battery charging control, but is required if a generator is configured to start/stop automatically based on SoC.

More information:

[VRM Portal FAQ - difference between BMV SOC and VE.Bus SOC](#)

See [Configurable Parameters Section \[87\]](#) on Battery monitor selection and Has DC system.

9.2.3. Selecting SoC source

The State of Charge (SoC) source can be selected under: Settings → System Setup → Batteries → Battery monitor.

The selected source determines which SoC value is displayed on the Overview screen of your GX device.

Automatic mode

When Automatic is selected, the system follows this logic:

In the same image we have chosen the Automatic setting. When automatic is selected, the System setup screen will be as shown in the next image.

The 'Automatic' function uses the following logic:

1. When available, it will use a dedicated battery monitor, such as the BMV, SmartShunt, Lynx Smart BMS or a Lynx Shunt VE.Can, or a battery with built-in battery monitor.
2. When there is more than one of those connected, it will use a random one - although you can select one manually.
3. When there is no dedicated battery monitor, it will use the VE.Bus SoC.

When to Use 'No Battery Monitor'

Select No battery monitor in systems where:

- A Multi or Quattro is installed
 - No BMV, SmartShunt, or equivalent monitor is present
 - Additional DC loads or chargers are connected to the battery but are not integrated with the GX device
- ⚠ In this setup, the VE.Bus SoC may be inaccurate, as it does not account for unmonitored current from other DC sources or loads.

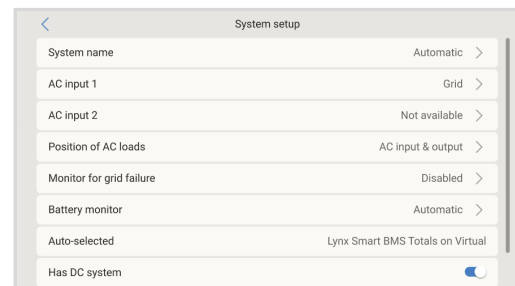
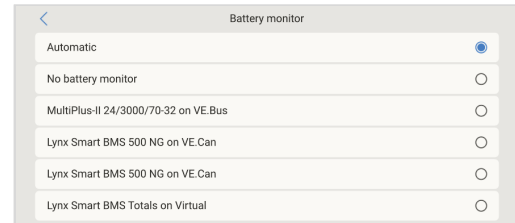

9.2.4. Details on VE.Bus SOC

While the inverter/charger is in Bulk, the State of Charge (SoC) will not exceed the value set in VEConfigure under: General tab → State of charge when Bulk finished (default: 85%).

In systems with solar chargers, ensure that the absorption voltage set in the MPPT is slightly higher than the setting in the inverter/charger. This allows the inverter/charger to detect the transition to Absorption, which is required for SoC to increase beyond the Bulk limit.

⚠ If the inverter/charger does not detect Absorption, the SoC will remain fixed at the configured End-of-Bulk percentage (default: 85%).

9.2.5. The System Status menu

The System Status menu (Settings → System Setup → System Status) provides diagnostic flags to help identify system behaviour and potential issues.

⚠ This menu is read-only and cannot be used to configure settings. It is only visible for Access level Superuser, and the visibility and state of each flag depend on the system configuration and connected devices.

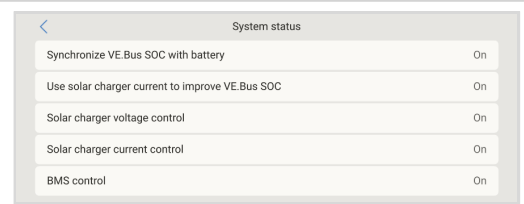

Diagnostic flags explained

1. Synchronise VE.Bus SoC with battery:

- If On, it indicates that the Multi/Quattro's internal battery monitor is automatically syncing its SoC with a more accurate source—such as a BMV, SmartShunt, or BMS.

2. Use solar charger current to improve VE.Bus SoC:

- In a VE.Bus system without a dedicated battery monitor, but with Victron solar chargers, the GX device factors in solar charge current to improve the SoC calculation by the Multi/Quattro.

3. Solar charger voltage control:

- The solar chargers are not using their internal charge algorithm, but are instead following an external voltage setpoint, either from a managed battery or, in ESS systems, from the Multi/Quattro.

4. Solar charger current control:

- The system is limiting solar charger output current, based on:
 - A managed battery, or
 - A user-defined maximum charge current set under DVCC

5. BMS control:

- The charge voltage is being controlled by the BMS, overriding the absorption and float voltages configured in the inverter/charger or solar charger.

9.3. Temperature relay configuration

It is possible to configure the built in Relay 1, and Relay 2 (if applicable), to activate and deactivate based on temperature. See [Connecting Temperature Sensors section \[32\]](#) for compatibility and connection instructions.

Temperature Relay Control Configuration

1. Verify Sensor Connection

Ensure that the temperature sensors are correctly connected and reporting temperature values in the Device list.

2. Enable Temperature-Controlled Relay

The temperature relay is configured in Settings → Integrations → Relays → Function (Relay 1/2) → Temperature. Once enabled, the Temperature control rules menu will appear under the Relay section, displaying all detected temperature sensors.

3. Assign Sensors to Relay Control

- Each temperature sensor can be assigned to control a relay.
- Select the desired temperature sensor for relay control. Sensors not assigned will display “No actions”.
- The temperature relay control can be enabled or disabled for each sensor within this menu.

4. Multi-Relay and Multi-Sensor Configuration (Applicable to GX products with two relays: Cerbo GX, Cerbo-S GX, Ekran GX)

- A single temperature sensor can control both relays.
- A single relay can be controlled by multiple temperature sensors.
- Example: A Cerbo GX managing two lithium battery heat pads, activating both simultaneously only when required.

Example Configuration: Dual-Stage Heating Control

1. Navigate to Relay → Temperature Control Rules → Temperature Sensor

2. Configure Condition 1 (Primary Heating – Relay 1)

- Enable Relay activation on temperature
- Assign relay control to Relay 1
- Set Activation value to 5°C and Deactivation value to 10°C

Relay 1 activates at 5°C and stays on until 10°C. If this is insufficient, a second heat pad can be connected to Relay 2.

3. Configure Condition 2 (Secondary Heating – Relay 2)

- Move down the menu to Condition 2 and assign relay control to Relay 2
- Set Activation value to 4°C and Deactivation value to 6°C

If the temperature drops to 4°C, Relay 2 activates and deactivates at 6°C, while Relay 1 remains active until 10°C.

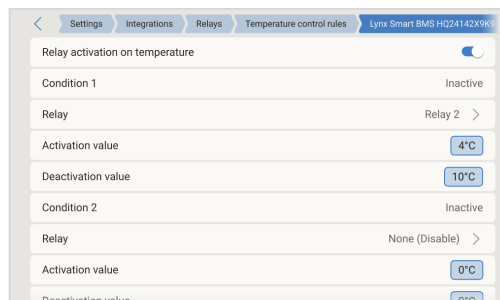
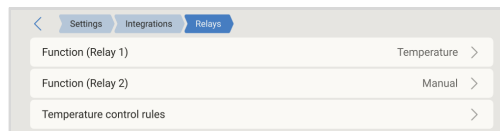

Note that the physical wiring contacts are available for both Relay 1 and Relay 2 in Normally Open and Normally Closed configurations.



Note the specifications for the power limits of the relays. It may be necessary to connect appliances via an additional contactor if power requirements exceed the relay power limit specification.

9.3.1. Heating & cooling control for batteries

Together with the Victron NG batteries, the GX device can use its relay to control battery heating in cold conditions and cooling when required and without adding an extra temperature sensor. The purpose is to enable charging at the battery's lowest permitted temperature by energising the heaters until the minimum charge threshold is reached.

This function:

- Requires a Lynx Smart BMS NG (does not work with the Small BMS NG or VE.Bus BMS NG).
- Also works with other compatible managed batteries, provided they transmit cell temperature data to the GX device.
- Requires suitable heating pads and/or cooling devices to be installed.

Follow these steps to set up heating and cooling control for batteries:

1. Go to Settings → Integrations → Relays.
2. Set the relay function to Temperature.
3. Open the Temperature control rules submenu and select the Lynx Smart BMS NG (or another compatible managed battery) as the temperature source.
4. Enable Relay on temperature.
5. Define the activation and deactivation values.

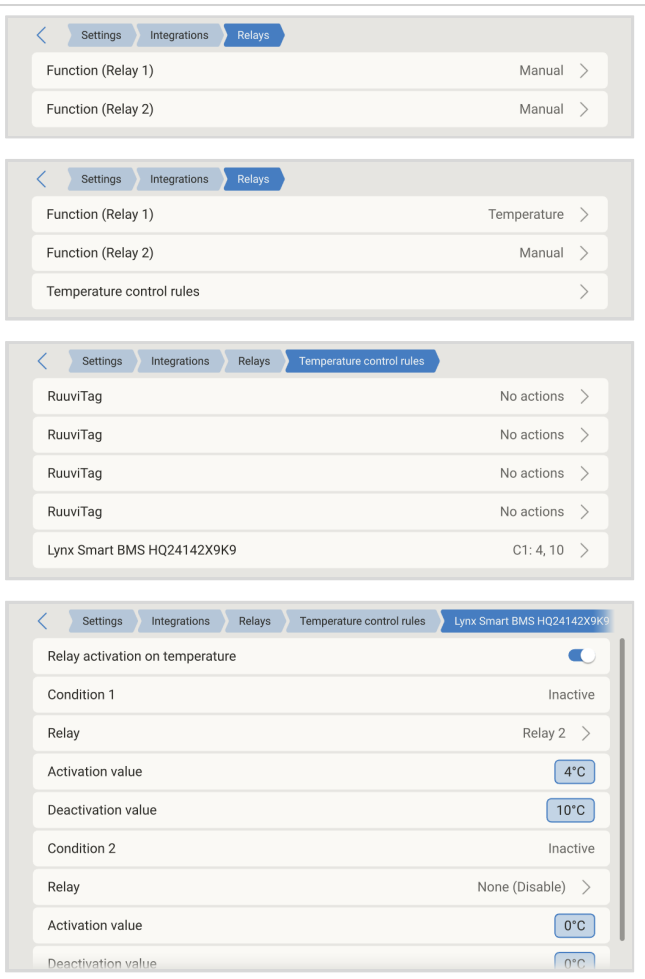

10. Firmware updates

The Ekrano GX requires at least Venus OS firmware version 3.00.

10.1. Changelog

The changelog is available on [Victron Professional](#), in the Firmware → Venus OS directory.

This section provides detailed release notes, version history, and firmware files for each Venus OS version.

To access Victron Professional, you need to sign up for an account. Registration is free.

If you do not yet have access:

1. Visit professional.victronenergy.com
2. Click Sign up
3. Fill in your details and confirm your email address

Once registered and logged in, navigate to the Firmware section, then open the Venus OS directory to view the changelog and download the relevant files.

10.2. Firmware update methods

There are two ways to update the firmware:

1. Via the internet - Update manually or enable automatic daily update checks.
2. Using a microSD card or USB stick - Download the firmware file, copy it to the storage device, and install it via the GX device menu.

10.2.1. Direct download from the internet

On GX devices without a display (ie. a Venus GX or Cerbo GX without GX Touch), use [Remote Console to access the menus described below](#).

1. To perform a firmware update via the internet, navigate to: **Settings** → **General** → **Firmware** → **Online updates**.
2. Press 'Check for updates'.
3. If a new firmware version is available, it will appear under Update available → Press to install the update.
4. If no update is available, a notification will confirm this.
5. After updating, verify the installation settings.

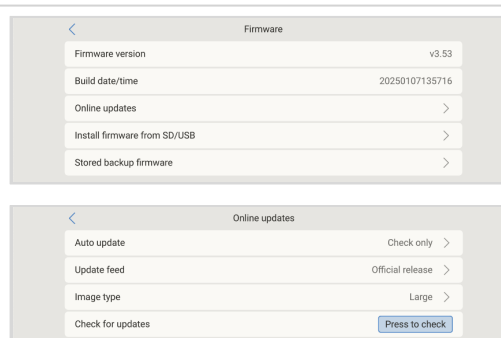

For most systems, we recommend leaving automatic updates disabled (which is also the factory default). Instead, perform updates during scheduled maintenance, ideally when qualified personnel are on-site to revert changes or troubleshoot if needed.



Upgrading Venus OS versions older than v2.20 (2018) is no longer possible via the internet. For these systems, use the microSD card or USB stick update method instead. Once the firmware has been updated, internet-based updates will function normally again.

10.2.2. MicroSD-card or USB-stick

Updating with a microSD-card or USB-stick is called 'Offline updating'. Use it when updating a device that is not connected to the internet.

1. Download the latest swu file:

- [Ekrano GX - venus-swu-ekrano.swu](#)

Note that the same files and the changelog is available on [Victron Professional](#). There is also a Dropbox connection to connect your Dropbox to our shared folder, so you always have the latest firmware files available on your laptop.

2. Install on a microSD-card or USB-stick

- Store the file in the root folder of a USB-stick or microSD-card.

3. Insert the microSD-card or USB-stick into the USB port of the GX device

4. Initiate the update

- Navigate to: **Settings** → **General** → **Firmware** → **Install firmware from SD/USB**.
- Click 'Check for updates on SD/USB'.
- The entry 'Firmware found' will appear. Ensure that the firmware on the microSD-card or USB-stick is newer than the currently installed version. Click it to initiate the update process.

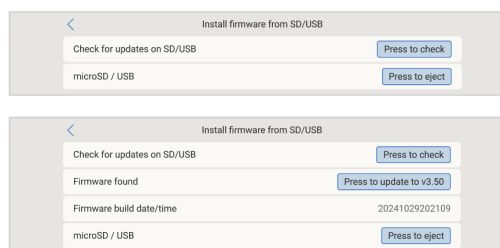

10.3. Revert to a previous firmware version

There are two ways to revert to an earlier firmware version:

1. **Using the Stored firmware backup feature** - This allows you to restore the previously installed version directly from the device.
2. **Manual installation via SD/USB** - Download the required firmware file, copy it to a microSD card or USB stick, and install it via Settings → General → Firmware → Install from SD/USB.

10.3.1. Stored firmware backup feature

This feature allows you to switch between the current and previous firmware version without requiring internet or SD-card access.

To revert using the stored backup:

1. Navigate to: **Settings** → **General** → **Firmware** → **Stored backup firmware**
2. The screen will display:
 - The currently running firmware version
 - The stored firmware version available to boot
3. Click Press to boot to start the stored version.

The system will now boot the stored firmware, and the current version will be saved as the new backup.

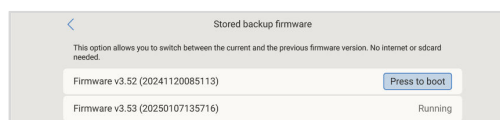

10.3.2. Install a specific firmware version from SD/USB

In some cases, it may be necessary to manually install a specific firmware version, such as an older version that is no longer available under Stored backup firmware on the GX device. This section explains how to perform a manual firmware installation using a USB stick or microSD card.

1. Old Venus OS firmware versions are available for download here: <https://updates.victronenergy.com/feeds/venus/release/images/>
2. For the Ekran GX, select the ekran folder
3. Download the .swu file for the required version
4. Place the .swu file in the root directory (not in a folder) of a USB-stick or MicroSD-card.
5. Insert the USB-stick or MicroSD-card into the GX device.
6. On the GX device: Go to **Settings** → **General** → **Firmware** → **Install firmware from SD/USB**.
7. Click Check for updates on SD/USB
8. The firmware version should appear under Firmware found. Click on it to start the installation

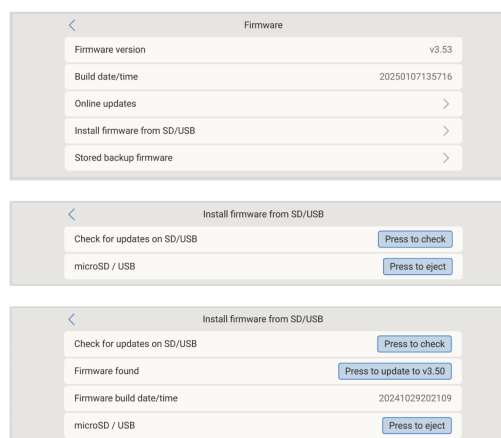

While backporting to older firmware versions is generally supported, some settings may be reset to their default values during the process. Please double-check your configuration after installation.

10.4. Venus OS Large image

In addition to the normal Venus OS firmware, it is also possible to install Venus OS Large, an extended build of Venus OS that adds Node-RED and Signal K Server.

Node-RED

Node-RED enables powerful customisation and automation. Key features include:

- A fully customisable dashboard accessible via a web browser (locally or remotely via VRM)
- Flexible logic flows, ideal for system automation, notifications, and visualisation

Signal K Server

Signal K Server is mainly intended for marine applications. It acts as a data multiplexer, supporting:

- NMEA 0183, NMEA 2000, Signal K, and other data sources
- All data from the GX device and connected systems is made available in Signal K for integration, processing, or display in external applications

Note: The additional features provided in Venus OS Large are not officially supported by Victron Energy. Use is at your own discretion.

Installation

1. On the GX device, go to: Settings → General → Firmware → Online updates → Image type
2. Select 'Large' to switch to Venus OS Large.
3. Proceed with the firmware update as described in this manual.

For further details and feature descriptions, refer to the documentation: [Venus OS Large image: Signal K and Node-RED](#)

11. VE.Bus Inverter/charger monitoring

11.1. Grid Current Limit Setting

This section explains the implications of enabling or disabling user control of the Grid current limit setting, as seen in the menu Device List → [your inverter/charger].

The limit as set by the user in the Ekrano GX will be applied to all inputs where the **'Overruled by remote'** setting in VEConfigure is enabled.

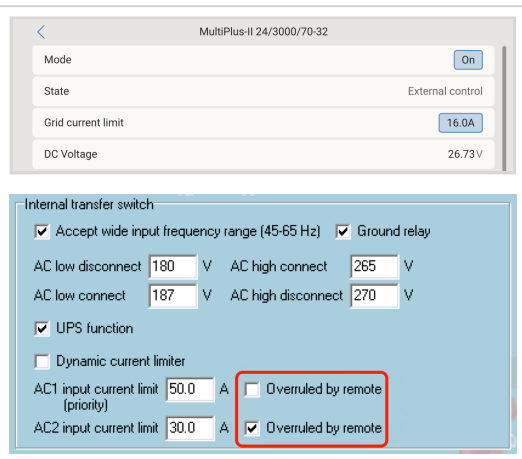

Example Configuration for a Boat with Two AC Inputs and a Quattro:

- A genset capable of delivering 50A is connected to input 1;
- Shore power is connected to input 2 (available power depends on the rating of the harbour power supply).

Configure the system exactly as shown in the VEConfigure screenshot above. Input 1 takes priority over Input 2, meaning the system will automatically connect to the genset whenever it is running, applying a fixed input current limit of 50A. When the genset is not available and mains power is present on Input 2, the Quattro will use the input current limit as configured in the EGX.

Two more examples: (In both cases, if you disable 'Overruled by remote', setting a current limit in the EGX will have no effect. And if you enable 'Overrule by remote' for both inputs, the current limit set in the EGX will be applied to both inputs.)

Minimum Grid Current Limit Values

When PowerAssist is enabled in VEConfigure, there is a minimum input current limit. The actual limit differs for each model. After setting the input current to a value below the limit, it will automatically be increased again to the limit.

Note that it is still possible to set the input current limit to 0. When set to 0, the system will be in passthrough (charger disabled).

Parallel and Three-phase Systems

The configured AC input current limit is the total limit per phase.

11.2. Phase rotation warning

The AC supply, whether from a generator or the grid, to a three-phase inverter/charger system must have the correct phase rotation, also known as phase sequence. If the phase sequence is incorrect, the inverter/chargers will not accept the AC supply and will remain in inverter mode. A phase rotation warning will be triggered in this case.

To resolve the issue, adjust the wiring on the AC input by swapping either one of the phases, effectively changing the rotation from L3 → L2 → L1 to L1 → L2 → L3. Alternatively, you can reprogram the Multi units and modify the phase assignments to match the wiring.

On the GX device, the warning will pop up as a notification on the GUI. It is also visible in the inverter/charger device menu.

On the VRM Portal, the warning appears in the VE.Bus Alarms & Warnings widget on the Advanced page and will be listed in the alarm log. Additionally, an email will be sent using [the VRM Alarm Monitoring system](#).

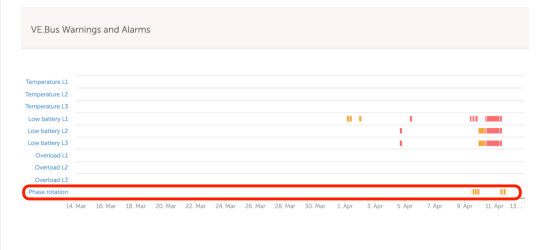

11.3. BMS connection lost alarm

This alarm is triggered when the inverter/charger receives CVL, CCL, or DCL data from a managed battery and subsequently loses communication with the battery or if the battery disconnects. It is also raised if the inverter/charger loses connection to the VE.Bus BMS. In both cases, the inverter/charger will shut down to protect the system.

Please note that a Low battery voltage alarm may also appear. However, this alarm is not due to low battery voltage but rather a lack of information from the battery due to a communication loss.

To resolve the alarm, restore the connection with the BMS or restart/power cycle the inverter/charger. A restart can be performed from the [Advanced menu \[107\]](#) of the VE.Bus device.

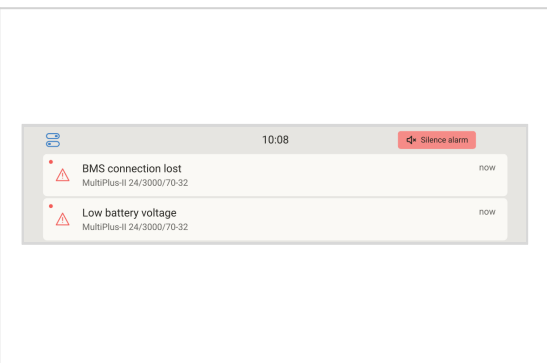

11.4. Grid failure monitoring

An alarm is triggered when this feature is enabled if the system has not connected to the AC input configured as Grid or Shore for more than 5 seconds.

- The alarm shows as a Notification in the GUI and as an alarm on the VRM Portal. It is also available on ModbusTCP / MQTT.
- This feature is recommended for backup systems, as well as for yachts or vehicles connected to shore power.

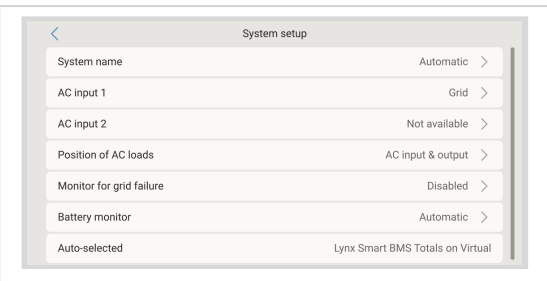



- This setting monitors the system's connection to Grid/Shore only. Generator monitoring is provided separately through the Generator start/stop function and is not part of this setting.
- Do not use this feature in systems that use the Ignore AC Input settings in our inverter/chargers: when the system ignores the AC input, ie. runs in island mode, as intended, even though the grid is available, it will report a grid failure.

11.5. Advanced menu

The Advanced menu can be accessed via Device List → [MultiPlus or Quattro] → Advanced. It contains options for equalization, re-detecting and restarting the VE.Bus system, and displays the ESS relay test status.

- **Equalisation:** Starts equalisation. See Multi or Quattro documentation for details.
- **Redetect VE.Bus system:** Clears the cache on the Ekran GX that has certain data of the VE.Bus system stored to keep the boot time as short as possible. Use this feature if, for example, a VE.Bus BMS used to be part of a system and is no longer used or replaced by a Lynx Smart BMS. When using Redetect VE.Bus system, the inverter/charger does not switch off for a couple of seconds like it would do when using Restart VE.Bus system.
- **Restart VE.Bus system:** Restarts the inverter/charger (just like switching it off and on again from the main rocker switch at the front) if it fails to restart automatically (after 3 attempts), for example, after a (very) heavy overload; or three overloads in a row. Any persistent errors such as a repeated and unrecoverable overload error, are deleted.
- **AC Input 1 ignored:** Status of the AC Input 1 flag
- **ESS Relay test:** Shows the status of the ESS Relay test. Only relevant when it's an ESS system. See Q9 in the [ESS Manual FAQ](#) for details.

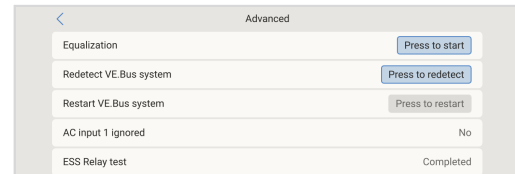

11.6. Alarm status monitoring

The Alarm status monitoring page can be accessed from Device List → [Multi or Quattro] → Alarm status. It displays diagnostic information on specific parameters to help with troubleshooting and provides additional information on the [VE.Bus error 8/11](#).

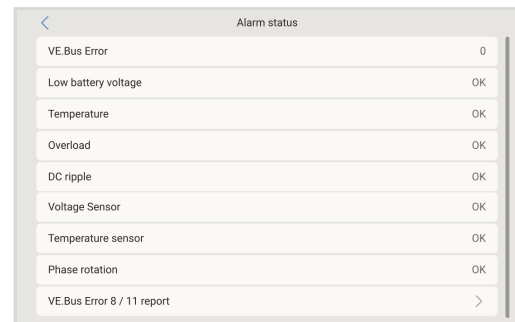

11.7. VE.Bus alarm setup menu

When using a VE.Bus system, you can configure the severity of issues that will trigger notifications (and an audible alert) on the Ekran GX.

To change the VE.Bus alarm & warning notifications, proceed as follows:

- From the Settings menu, go to Devices → [your VE.Bus product] → Alarm setup
- Choose between the following notification settings for each alarm:
 - Disabled:** The EGX will never beep or show a notification. Not recommended.
 - Alarm only** (default): The EGX will only beep and show a notification when the VE.Bus system switched off in an alarm condition. Warnings are ignored.
 - Alarms & warnings:** The EGX will beep and show a notification on all selected alarms and warnings.
- Scroll to the bottom of the list and enable or disable VE.Bus error notification.

When all is done, don't forget to change the access level to User when required.

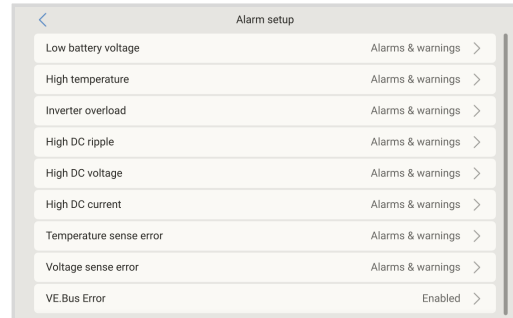

11.8. Device menu

The Device menu (Device List → [Multi or Quattro] → Device) offers device-related parameters such as custom name setting, firmware version, serial numbers (in the sub-menu) and more that can be used for diagnostics.

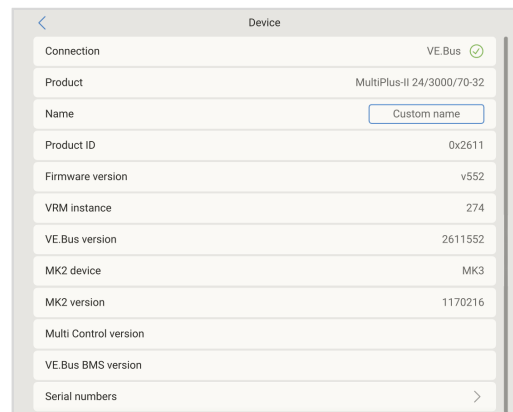

11.9. VE.Bus Settings Backup & Restore

The VE.Bus Settings Backup & Restore feature allows you to save the full configuration of a Multi or Quattro to a GX device and restore it when needed.

This makes it easy to:

- Recover a system quickly after replacing a faulty unit, without the need for full manual reconfiguration.
- Switch between different configurations, for example from single-phase to three-phase in a hybrid genset setup (which then needs to include the required contactors to change the physical wiring as well).

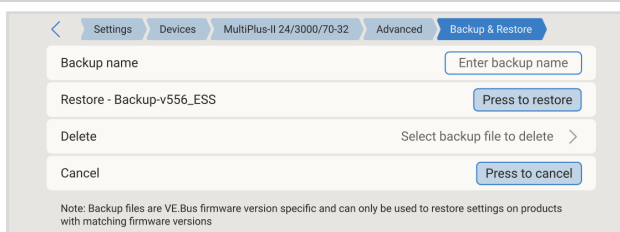

Backup process

The backup process works in the same way as a Remote VE.Configure download in VRM; while the backup is in progress, the GX display will stop reporting information from the VE.Bus device.

1. Go to Settings → Devices → [Your_Multi_or_Quattro] → Advanced → Backup & Restore.
2. Give the backup a clear and descriptive name. Tip: include the firmware version, as only backup files that match the firmware version of the Multi/Quattro can be restored.
3. Tap Press to backup to start the process.
4. Once complete, the configuration is stored on the GX device and a notification is displayed.

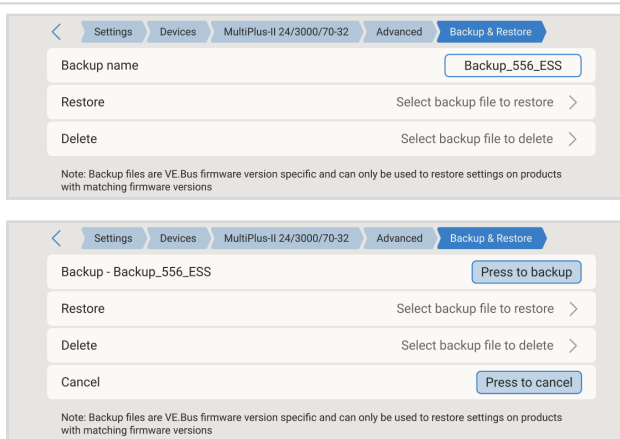

Restore process

The restore process works in the same way as a Remote VE.Configure upload in VRM. If the configuration includes assistants or settings that require a restart, the system will restart during the restore process.

1. Go to Settings → Devices → [Your_Multi_or_Quattro] → Advanced → Backup & Restore.
2. Tap Restore and select the backup file to use.
3. Tap Press to restore to start the process.
4. After completion, the configuration is restored and active. The system resumes normal operation, and a notification is displayed.

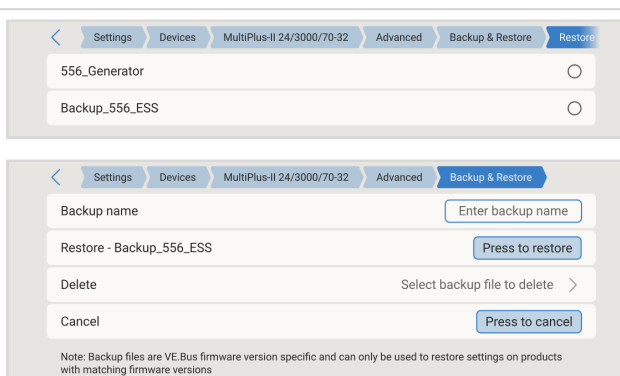

11.10. Solar & Wind Priority

The solar and wind priority function ensures that solar and wind energy are used to charge the battery. At the same time, shore power is only used to prevent the battery from becoming too deeply discharged.

When activated, the system remains in this mode, called Sustain, for seven days; if there is not enough sun or wind, a full charge cycle will take place, charging the batteries to 100%. This ensures they remain in optimal condition and are ready for later use.

After these seven days, the system will not return to sustain mode. Instead, it will keep the batteries fully charged and prioritise solar power over shore power wherever possible during the day to run DC loads such as pumps and alarm systems.

For details and configuration, please see the [Solar & Wind Priority manual](#).

12. DVCC - Distributed Voltage and Current Control

12.1. Introduction and features

Enabling DVCC (under Settings → System Setup → Charge Control) changes the GX device from a passive monitor into an active system controller. The available DVCC features depend on:

- The type of battery in use
- The installed Victron components
- Their configuration

Example 1 - Managed CAN-bus batteries:

When a managed CAN-bus BMS battery is connected, the GX device receives:

- Charge Voltage Limit (CVL)
- Charge Current Limit (CCL)
- Discharge Current Limit (DCL)

These values are passed to connected inverter/chargers, solar chargers, and Orion XS DC-DC chargers, which then disable their own charging algorithms and follow the battery's instructions directly.

Example 2 - Lead-acid batteries:

For lead-acid systems, DVCC enables:

- A configurable system-wide charge current limit, where the GX device actively limits the inverter/charger if solar chargers are already operating at full output.
- Shared Temperature Sense (STS)
- Shared Current Sense (SCS)

These features enhance coordinated charging behaviour across the system.

This table shows the recommended settings for different battery types:

	Lead-acid	VE.Bus BMS V1 Lithium	VE.Bus BMS V2 ¹⁾ Lithium	VE.Bus BMS NG ¹⁾ Lithium	Supported 3rd party managed batteries ²⁾
Auto-config	No	No	No	No	2)
System charge current	Yes	Yes	Yes	Yes	2)
Should you enable SVS?	Yes	3), 4)	3), 4)	3), 4)	2)
Should you enable STS?	Yes	No	No	No	2)
Should you enable SCS	Yes	3), 4)	3), 4)	3), 4)	2)

¹⁾ DVCC must be enabled for the GX device to control the solar chargers, Inverter RS or Multi RS in a system with a VE.Bus BMS V2 or VE.Bus BMS NG.

²⁾ Use the [Battery Compatibility manual](#) to see which parameters need to be set and which are set automatically.

³⁾ In an ESS system the VE.Bus device is already synced with the solar chargers, so we recommend leaving SVS and SCS off.

⁴⁾ For all other systems: If a BMV or SmartShunt is installed, we recommend enabling SVS and SCS. In all other cases, leave SVS and SCS disabled.

⁵⁾ Solar Chargers, Inverter/Chargers, Multi RS, Inverter RS and Orion XS do not require wiring. All other loads and chargers must be wired and controlled via ATC/ATD.

	Lead-acid	VE.Bus BMS V1 Lithium	VE.Bus BMS V2 ¹⁾ Lithium	VE.Bus BMS NG ¹⁾ Lithium	Supported 3rd party managed batteries ²⁾
Charge control method	N/A	N/A	N/A	N/A	2)
Wire ATC & ATD	N/A	Yes	5)	5)	2)
<p>¹⁾ DVCC must be enabled for the GX device to control the solar chargers, Inverter RS or Multi RS in a system with a VE.Bus BMS V2 or VE.Bus BMS NG.</p> <p>²⁾ Use the Battery Compatibility manual to see which parameters need to be set and which are set automatically.</p> <p>³⁾ In an ESS system the VE.Bus device is already synced with the solar chargers, so we recommend leaving SVS and SCS off.</p> <p>⁴⁾ For all other systems: If a BMV or SmartShunt is installed, we recommend enabling SVS and SCS. In all other cases, leave SVS and SCS disabled.</p> <p>⁵⁾ Solar Chargers, Inverter/Chargers, Multi RS, Inverter RS and Orion XS do not require wiring. All other loads and chargers must be wired and controlled via ATC/ATD.</p>					

12.2. DVCC Requirements

1. Battery compatibility

- For CAN-bus connected batteries, refer to the relevant page in the [Battery Compatibility manual](#) to see if enabling DVCC has been tested with your battery type and is supported. → Only enable DVCC if it is explicitly listed as supported for your battery type.
 - ⚠ If DVCC is not mentioned in notes relating to your battery, do not enable it.
- DVCC is fully supported and can be used without issue for:
 - Lead-acid batteries (Gel, AGM, OPzS, etc.)
 - Victron Lithium Smart with:
 - VE.Bus BMS
 - Lynx Ion + Shunt BMS
 - Lynx Ion BMS
 - Victron Lithium NG with:
 - VE.Bus BMS NG
- For systems with the Lynx Smart BMS or Lynx BMS NG, DVCC is automatically enabled and cannot be disabled.

2. Firmware versions

- Do not use DVCC if firmware requirements are not met.
- During commissioning, always install the latest available firmware.
- Once the system is running reliably, firmware updates are not required unless needed.
- If issues occur, the first step should be to update firmware.

Required minimum firmware versions:

Victron product	Minimum firmware version
Multi/Quattro	422
MultiGrid	424
Multi RS, Inverter RS, MPPT RS	v1.08
GX device	v2.12
VE.Direct MPPTs	v1.46
VE.Can MPPTs with VE.Direct	v1.04
Older style VE.Can MPPT Solar Chargers (with the screen)	Cannot be used
Lynx Ion + Shunt	v2.04
Lynx Ion BMS	v1.09
Lynx Smart BMS	v1.02
Lynx BMS NG	v1.10
Orion XS	v1.00

Firmware compatibility warning – Error #48

Starting from Venus OS firmware v2.40, the GX device will display the warning: **Error #48 – DVCC with incompatible firmware**

This indicates that one or more connected devices are running firmware versions incompatible with DVCC.

For further details on this error, refer to the [Error codes chapter \[193\]](#).

ESS system requirement

If using an ESS system, ensure the ESS Assistant is version 164 or later (released November 2017), as earlier versions are not compatible with DVCC.

12.3. DVCC effects on the charge algorithm

In standalone mode, our inverterchargers, MPPT solar chargers and Orion XS use their own internal charging algorithm. This means they determine how long to remain in Absorption, when to switch to Float, and when to switch back to Bulk or Storage. In those various phases, they use the configured parameters in VictronConnect and VEConfigure.

In ESS systems and systems with managed batteries (see the [Battery Compatibility manual](#)), the internal charge algorithm is deactivated, and the charger then works with an externally controlled charge voltage setpoint. This table explains the different possibilities:

Selection guide			Resulting charge algorithm		
System type	Battery type	DVCC	Inverter/charger	Solar charger	Orion XS
ESS Assistant ¹⁾	Intelligent battery	On	Battery		
		Off	Don't do this; better enable DVCC		
	Normal battery	On	Internal	Inverter/charger	
		Off	Internal	Inverter/charger	
Standard	Intelligent battery	On	Battery		
		Off	Don't do this; better enable DVCC		
	Normal battery	On	Internal		
		Off	Internal		

¹⁾ The ESS Assistant is only installed in a specific type of power system that integrates a grid connection with a Victron inverter/charger, GX device and battery system, not to be confused with an off-grid system such as is used in boats or RVs.

Details

• Internal

- The internal charge algorithm (bulk → absorption → float → re-bulk), and the configured charge voltages are active.
- Inverter/charger indicates charge state: bulk, absorption, float, and-so-forth.
- The MPPT indicated charge state is: bulk, absorption, float and-so-forth.
- The Orion XS DC-DC battery charger indicated charge state is: bulk, absorption, float and-so-forth.

• Inverter/charger (applies to MPPTs and Orion XS only)

- The MPPTs and Orion XS internal charge algorithm is disabled; instead it's being controlled by a charge voltage setpoint coming from the inverter/charger.
- The MPPTs and Orion XS indicated charge state is: Ext. control.

• Battery

- The internal charge algorithm is disabled and instead, the device is being controlled by the battery.
- The Inverter/charger indicated charge state is: Ext. control.
- The MPPT and Orion XS indicated charge state is: Ext. control (the LEDs continue to show bulk and absorption, never float).

12.3.1. DVCC effects when there is more than one Multi/Quattro connected

When DVCC is enabled, the Multi/Quattro system connected to the built-in VE.Bus port (single unit, or multiple units configured for parallel, split-phase or three-phase operation) is controlled by DVCC.

A secondary Multi/Quattro connected to the GX device via an MK3-USB interface is not controlled by DVCC by default and operates according to its own internal configuration.

The Charge Control menu (Settings → System Setup → Charge Control) includes the option 'Managed battery controls all Multis and Quattros'. This option is only displayed when an additional Multi/Quattro is connected to the GX device via an MK3-USB interface.

When enabled (disabled by default), secondary Multi/Quattro devices connected via MK3-USB are also controlled by the managed (CAN-bus) battery.

In this case, the Charge Voltage Limit (CVL), Discharge Current Limit (DCL) and Charge Current Limit (CCL) provided by the BMS are duplicated to all connected Multis and Quattros. This ensures that all units use the same charge voltage, and that all units stop discharging if the battery requests discharge to stop.

Limited CCL control

The CCL is not distributed or shared between multiple inverterchargers. Instead, the full CCL value is applied to each controlled unit.

This behaviour is intended for systems where, for example, a genset is connected to the secondary Multi/Quattro. It is the responsibility of the installer to ensure that the CCL is not exceeded if multiple Multis/Quattros are charging at the same time.

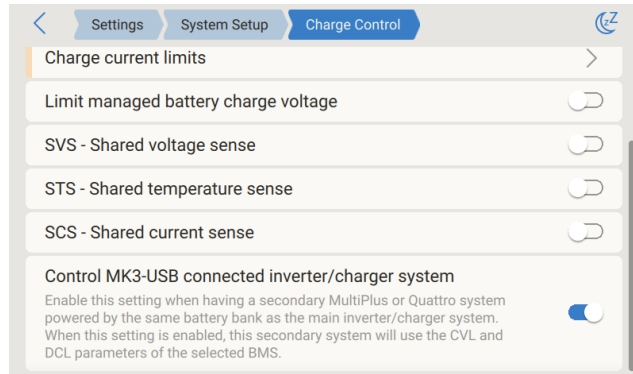

12.4. DVCC features for all systems

The following features apply to all system types when DVCC is enabled, regardless of whether:

- The ESS Assistant is used or not
- The system uses lead-acid or other standard batteries
- An intelligent CAN-bus BMS battery is installed

These features are active in all configurations where DVCC is enabled.

12.4.1. Limit charge current

Limit charge current is a user-configurable setting that defines the maximum total charge current allowed in the system. It is available under: Settings → System Setup → Charge Control on the GX device.

In systems with DVCC enabled, charge sources are prioritised as follows:

1. MPPT Solar Chargers (including MPPT RS)
2. Orion XS DC-DC Battery Chargers
3. Inverter/Chargers (including Inverter RS and Multi RS)



Particulars:

1. If a CAN-bus BMS is connected and the BMS requests a maximum charge current that is different from the user-configurable setting, the lower of the two will be used.
2. This mechanism only works for Victron inverter/chargers including Inverter RS, Multi RS, Solar chargers incl. MPPT RS and Orion XS DC-DC battery chargers. Other chargers, such as Skylla-i's are not controlled and also their charge current is not taken into account. The same applies for devices that are not connected to the GX device, such as an alternator. Worded differently: the total charge current of the inverter/chargers and all MPPT solar chargers will be controlled, nothing else. Any other sources will be extra charge current, unaccounted for. Even when installing a BMV or other battery monitor.
3. DC Loads may not be accounted for, unless a SmartShunt or BMV-712 is installed and correctly configured as a [DC meter](#). For example, without the DC load monitor a configured maximum charge current of 50A and DC Loads drawing 20A, the battery will be charged with 30A, not with the full allowed 50A. With the SmartShunt configured as a DC meter, maximum charge current configured at 50A and DC system shunt reports a draw of 25A, then the chargers are set to charge with $50 + 25 = 75A$.

If you have one or more shunts configured for "DC system" (when more than one, they are added together), then the DVCC charge current limit compensates for both loads and chargers. It will add extra charge current if there is a load, and subtract it if there is another charger in the DC system. DC "loads" and "sources" are not compensated for in either direction.

4. Current drawn from the system by the inverter/charger is compensated for. For example, if 10A is drawn to power AC loads and the limit is set to 50A, the system will allow the MPPT solar chargers to charge with a maximum of 60A.
5. In all situations, the maximum charge limit configured in a device itself, i. e. the Charge current limit set with VictronConnect or VEConfigure for Orion XS DC-DC battery chargers, MPPT solar chargers or inverter/chargers will still be in effect. An example to illustrate this: in case there is only an inverter/charger in the system and in VEConfigure or VictronConnect the charge current is configured to 50A. And on the GX device, a limit of 100A is configured, then the working limit will be 50A.
6. DVCC charge current limits are not applied to DC MPPTs when ESS is enabled with Allow DC MPPT to export. This is to get maximum output from the solar panels for export.

12.4.2. Limit managed battery charge voltage

Some managed batteries, such as BYD and Pylontech, may require a **reduced charge voltage** during their initial commissioning period. This helps ensure proper cell balancing in the first few weeks of operation.

The Limit managed battery charge voltage feature is designed specifically for this purpose.

When enabled, it allows to temporarily reduce the maximum charge voltage, even if the battery's BMS normally permits a higher voltage.

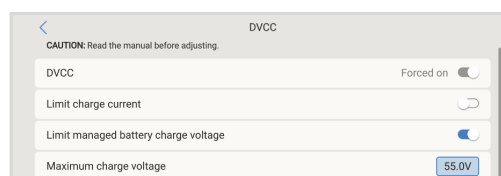



- **Do not use this feature for other purposes.**
Improper use may prevent cell balancing from occurring, leading to severe long-term imbalance.
- If the voltage is set above the CVL (Charge Voltage Limit) from the battery BMS, the lower value will be applied.

12.4.3. Shared Voltage Sense (SVS)

This feature is compatible with VE.Bus devices, VE.Direct and VE.Can MPPT solar chargers, Orion XS DC-DC battery chargers, as well as Inverter RS and Multi RS.

The system automatically selects the optimal voltage measurement. If available, it prioritises the voltage from the BMS or a BMV battery monitor. If neither is accessible, it defaults to the battery voltage reported by the VE.Bus system. The voltage displayed on the GUI corresponds to the selected voltage measurement.

Shared Voltage Sense (SVS) is enabled by default when DVCC is active. It can be manually disabled via a switch in Settings → System Setup → Charge Control. However, SVS (and DVCC) is force-enabled for the Lynx Smart BMS and Lynx Smart BMS NG and cannot be modified.

Note that SVS is force-disabled for some batteries. Please see the [compatibility page](#) for your battery.

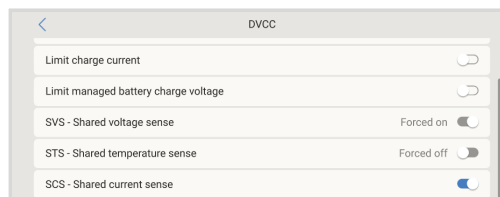

12.4.4. Shared Temperature Sense (STS)

STS allows the GX device to forward the measured battery temperature to all connected inverter/chargers, MPPT solar chargers, and Orion XS DC-DC chargers.

You can select the temperature source from:

- BMV-702 / BMV-712
- SmartShunt
- Lynx Shunt VE.Can battery monitors
- Temperature input on the GX device (if available)
- Multi/Quattro inverter/charger
- MPPT solar charger (with sensor installed)

Note: STS is forced disabled for the Lynx Smart BMS, Lynx Smart BMS NG, and some managed batteries. Refer to the [battery compatibility page](#) for details.

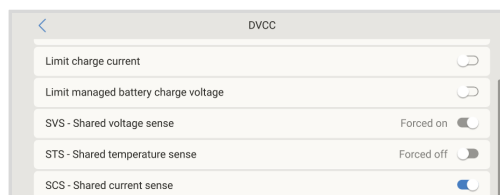

12.4.5. Shared Current Sense (SCS)

This feature shares the battery current, as measured by a battery monitor connected to the GX device, with all MPPT solar chargers and Orion XS DC-DC battery chargers.

These devices can use the shared current for the tail current mechanism, which ends absorption when the battery current drops below a set threshold. → Refer to the specific product documentation for configuration details.

Applicable only to systems not using ESS and not using a managed battery, as charge control for MPPT solar chargers and Orion XS is external in those cases.

Note: Requires MPPT solar charger firmware v1.47 or later.

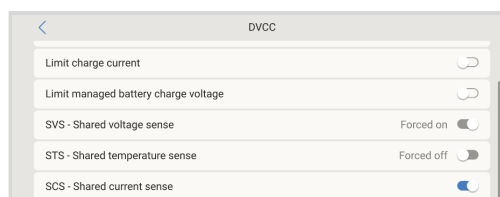

12.4.6. Controlling BMS

For systems with multiple BMSs connected, this feature enables the selection of a specific BMS for DVCC. It also allows a BMV or SmartShunt to be used for SoC tracking by configuring the BMV as the battery monitor (Settings → System setup → Batteries → Battery monitor), while the BMS remains active for DVCC.

This setting is available in the Settings → System Setup → Charge Control menu on the GX device.

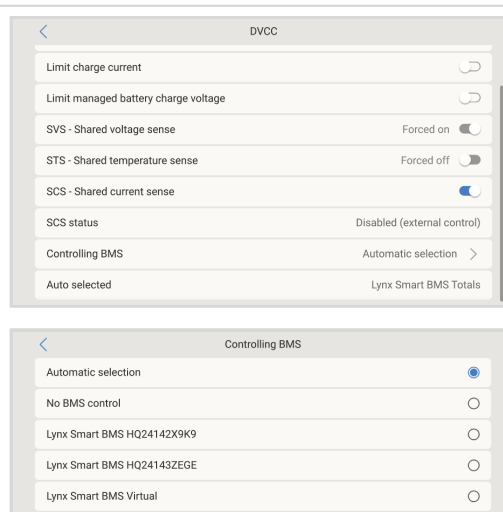

12.5. DVCC features when using CAN-bus BMS battery

This section applies to all systems using an intelligent battery BMS connected via CAN-bus.

This excludes the Victron VE.Bus BMS.

Such intelligent BMS sends the following parameters to the GX device:

1. **Charge voltage limit (CVL):** the maximum charge voltage that the battery currently accepts.
2. **Charge current limit (CCL):** the maximum charge current requested by the battery.
3. **Discharge current limit (DCL):** the maximum discharge current as requested by the battery.

For all three parameters, some types of batteries transmit dynamic values. For example they determine the maximum charge voltage based on cell voltages, state of charge, or for example temperature. Other makes and brands use a fixed value.

For such batteries there is no need to wire allow to charge (ATC) and allow to discharge (ATD) connections to the AUX inputs of a Multi or Quattro.

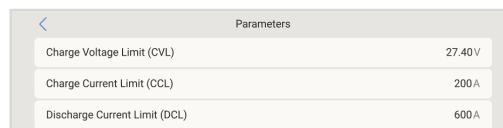

When inverting (i.e., in island mode), Multis and Quattros will shut down if the maximum discharge current is set to zero. They will automatically restart when either AC mains is restored or the BMS increases the maximum discharge current.

For more information on how the maximum charge current is configured, including prioritization of solar, refer to the previous section, [Limit charge current \[116\]](#).



It is important to note that configuring charge voltages or charge profiles in VEConfigure or VictronConnect is unnecessary and has no effect. The Multis, Quattros, Multi and Inverter RS, MPPT Solar Chargers, and Orion XS DC-DC battery chargers will charge using the voltage received via CAN-bus from the battery. This setup also applies to systems with a Lynx Smart BMS or Lynx Smart BMS NG connected to a GX device.

12.6. DVCC for systems with the ESS Assistant

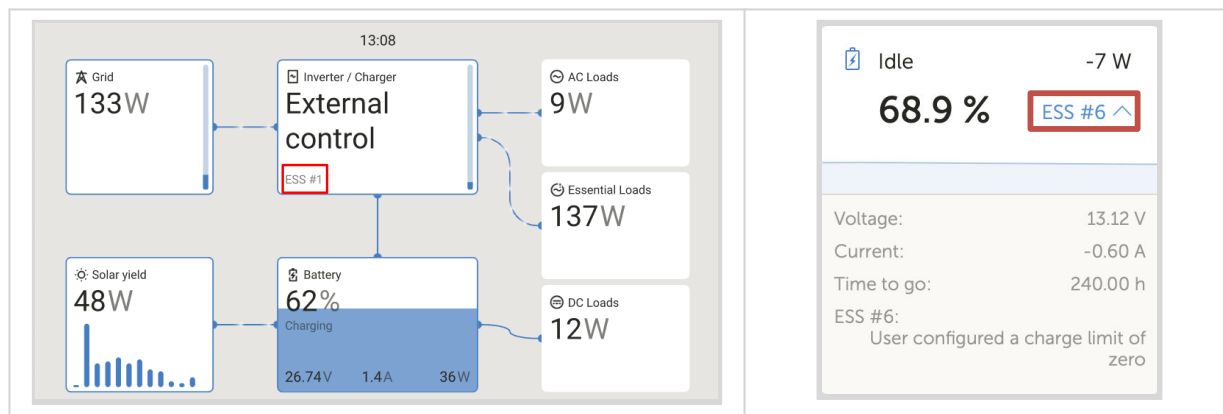

- The ESS Keep batteries charged mode will only work properly with DVCC enabled.
- A fixed solar offset of 0.4V (value for 48V system, divide by 4 for 12V) is applied when ESS-mode is set to Optimised in combination with the Feed-in excess solar charger power-setting enabled, or when ESS-mode is set to Keep batteries charged.
- For system with ESS mode Optimised and Optimised (with BatteryLife): The system will automatically recharge the battery (from the grid) when the SoC drops 5% or more below the value of 'Minimum SoC' in the ESS menu. Recharge stops when it reaches the Minimum SoC.
- ESS status display in the graphic overview of the GX device and on VRM: In addition to the charge status (External Control or Bulk/Absorption/Float), the following status can be displayed:

ESS status	Meaning
#1	Low SoC: discharge disabled
#2	BatteryLife is active
#3	Charging disabled by BMS
#4	Discharging disabled by BMS
#5	Slow charge in progress (part of BatteryLife, see above)
#6	User configured a charge limit of zero
#7	User configured a discharge limit of zero

- Note: When DC-coupled PV feed-in excess is enabled with ESS, the DVCC system will not apply the DVCC charge current limit from PV to battery. This behaviour is necessary to allow the export. Charge voltage limits will still apply. Charge current limits set at the individual solar charger device settings level will also still apply.
- When the BMS is disconnected in an ESS system, solar chargers will stop and show error #67 – No BMS (see the [MPPT Solar Charger Error Codes](#) for additional info).

13. VRM Portal

13.1. VRM Portal introduction

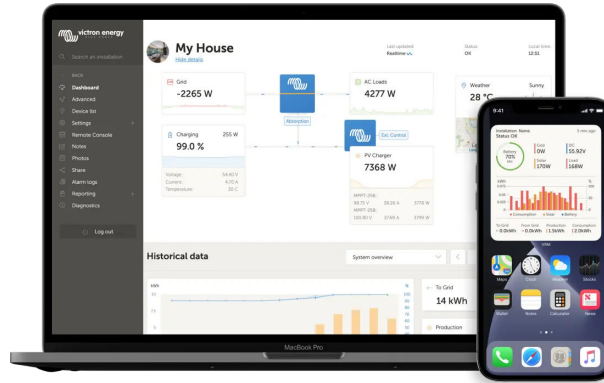

With VRM (Victron Remote Monitoring) you can remotely monitor, control, manage and optimise your Victron Energy systems and identify potential problems early by setting alerts and alarms.

When connected to the internet, a GX device unlocks a wide range of [VRM Portal](#) and [VRM App](#) features for monitoring, alerts, diagnostics, control, and management. Key features are summarised below.

- **Remote access:** Easy access to all statistics and systems status online
- **Remote Console on VRM:** [\[125\]](#) Access and configure your system as if you were standing beside it
- **Remote firmware update:** Update the firmware of connected solar chargers and other Victron products
- **Remote VEConfigure:** Download and upload Remote VEConfigure files from and to the Multi/Quattro connected to your GX device
- **Remote Controls:** Control devices such as the EV Charging Station, Inverter/charger, GX relay, Genset and ESS system remotely via VRM
- Use of the [VRM App for iOS and Android](#) including [VRM APP Widgets](#) on your mobile device's homescreen

See the [Internet Connectivity chapter \[77\]](#) for how to connect the device to the internet.

For a complete overview of all features and functions of the VRM Portal, see the [VRM Portal documentation](#).

13.2. Registering on VRM

Detailed instructions are in the [VRM Portal Getting Started document](#).

Note that the system must first successfully transmit data to the VRM Portal. If no successful connection has been established, the system cannot be registered to your VRM user account. In such cases, please refer to the sections [Troubleshooting data logging \[122\]](#) and [Remote Console on VRM - Troubleshooting \[126\]](#) below.

VRM device registration from touch screen

A GX device can be added to the VRM portal directly from a physical touch screen. The UI provides a QR code in Settings → VRM, removing the need to read the portal ID from the device sticker. This option is only available on physical touch screens such as the GX Touch 50, GX Touch 70, or Ekran GX.

VRM device registration from Remote Console

A GX device can also be added to the VRM portal via Remote Console. The Settings → VRM menu includes a link button, removing the need to read the portal ID from the device sticker.

13.3. Datalogging to VRM

Datalogs are transmitted to the VRM Portal via the internet, whenever available. All relevant settings are accessible via Device List → Settings → VRM online portal in the VRM Portal menu.

The datalog transmission is designed to function reliably, even over poor internet connections. Connections experiencing up to 70% sustained packet loss are still adequate for data transmission, although some delay may occur.

Note that data log transmission to VRM depends on the [Access settings for Remote Console & Controls pane in VRM \[125\]](#), which must be set to either Full (default) or Read-only.

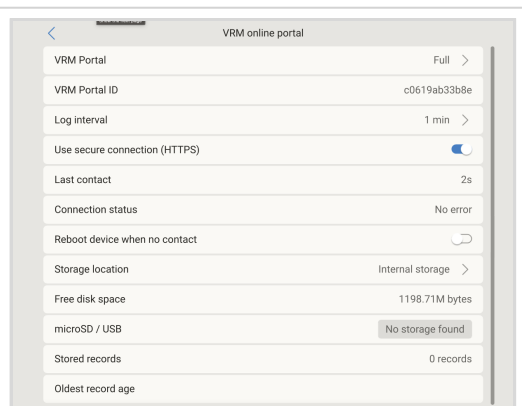

Adding External Storage

If the GX device cannot transmit logs to the VRM Portal, it stores them internally in non-volatile memory, retaining data even during power loss or reboot.

The internal buffer can hold logs for several days. To extend this period, insert a microSD card or USB stick. Check internal storage status via the settings menu. When external storage is inserted, internally stored logs automatically transfer to it, ensuring no data loss.

Regardless of external storage use, the GX device continually attempts to reconnect to the VRM Portal and upload any stored logs. Even with significant backlogs, data will be transmitted once internet connectivity is restored. Data transmission is compressed, significantly reducing bandwidth usage compared to continuous transmission.

Storage Device Requirements

- Supported file systems: FAT (12, 16, 32), exFAT, ext3, and ext4.
- microSD cards (SD and SDHC types) up to 32 GB typically come pre-formatted with FAT12, FAT16, or FAT32 and can be used immediately. Avoid reformatting them to unsupported file systems.

Manually Transferring Datalogs to VRM

For GX devices without permanent internet connectivity, data can be manually uploaded using a computer:

1. On the GX device, go to Settings → VRM and select Eject storage. Always eject storage devices properly to avoid data loss or corruption.
2. Remove the storage device and insert it into an internet-connected computer.
3. Open a web browser, and go to the [VRM Portal](#).
4. Log in and navigate to the Installations menu:

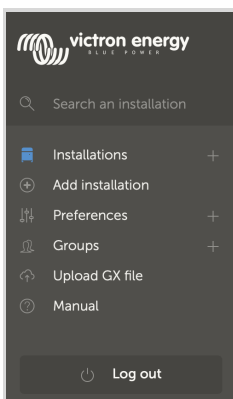

5. Click Upload GX file and follow the on-screen instructions (note the max file limit of 200MB):

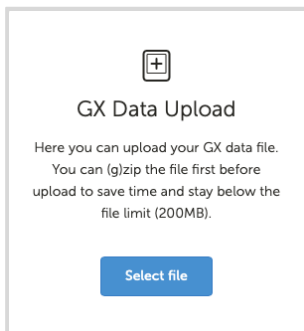

- After uploading, delete the file from the storage device before re-inserting it into the GX device. While duplicate uploads do not cause issues, it is best to avoid duplication.

Storage space requirement:

- Approximately 25 MB per month (with a one-minute log interval), depending on connected devices.
- A 1 GB microSD card can hold roughly three years of data, comfortably exceeding VRM's 6-month retention period.
- Once full, no additional data is logged.

If multiple storage devices are inserted, the GX device uses the first inserted device. If removed, logging continues internally until new external storage is inserted.

Network Watchdog: Reboot device when no contact

This optional feature (Settings → VRM - disabled by default) reboots the GX device if it fails to connect to the VRM Portal. Configure the "No contact reset delay" to set reboot intervals. For example, setting a one-hour delay causes hourly reboots until connectivity is restored.

13.4. Troubleshooting data logging

This section provides guidance for troubleshooting issues when the GX device cannot transmit data to the VRM Portal.

Initial check

First, verify that the GX device is connected to the VRM Portal and confirm if data transmission is occurring.

 Temporary internet connectivity issues are not a concern. Any unsent data logs will be temporarily stored on the GX device and automatically uploaded once connectivity is restored.

- Verify the connection status between the GX device and the VRM Portal by checking the 'Last contact' timestamp (Settings → VRM → Last contact).
 - If the timestamp is within the defined log interval, data transmission is functioning correctly.
 - If it shows dashes ("--"), the GX device has not connected to the VRM Portal since power-up.
 - If it displays a timestamp along with an error, the GX device has transmitted data previously but has since lost connection.
- Check the 'Stored records' value in the same menu:
 - The 'Stored records' indicates the number of logs that it has stored to send later.
 - A value of 0 indicates that all data has successfully transmitted to the VRM Portal.
 - A value greater than 0 indicates unsent logs due to connectivity issues, typically accompanied by an error message detailed further in this chapter
 - Continue reading if issues persist.

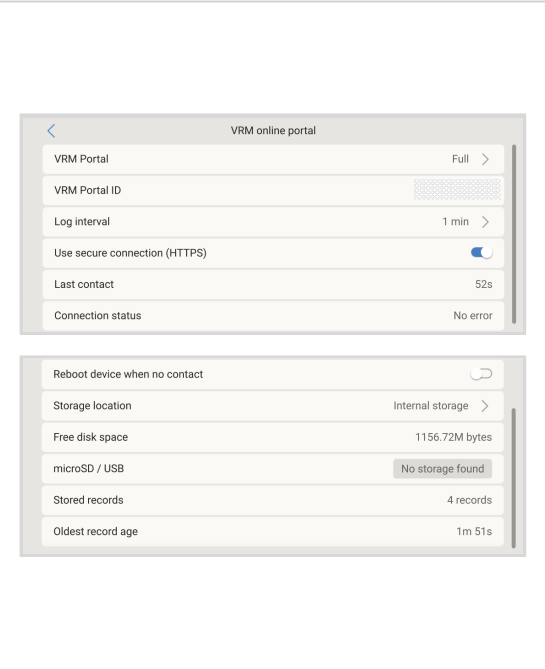

Required communication for sending data logs to the VRM portal:**1. Reliable Internet Connection:**

- Prefer wired Ethernet connections.
- Avoid tethered or mobile hotspot connections due to unreliability.

2. Correct IP Address:

- Typically assigned automatically via DHCP by the router.
- Manual configuration usually unnecessary.

3. Outbound HTTP(S) Connections:

- Must allow connections to <http://cgxlogging.victronenergy.com> on ports 80 and 443. That should never be an issue, unless on very specialised company networks.
- Proxy setups are unsupported.

For further details, refer to the FAQ [Q15: What type of networking is used by the Ekrano GX \(TCP and UDP ports\)? \[196\]](#) on network requirements.

Ethernet	
State	Connected
MAC address	
IP configuration	Automatic >
IP address	192.168.178.108
Netmask	255.255.255.0
Gateway	192.168.178.1
DNS server	192.168.178.1

Troubleshooting Steps**1. Update Firmware:**

- Ensure the GX device firmware is current (see the [Firmware updates \[102\]](#) chapter for details).

2. Verify Network and Internet Connection:

- Check IP address assignment in Ethernet or WiFi settings (Settings → Connectivity → Ethernet/Wi-Fi → IP configuration → Automatic) and confirm:
 - 'State' shows 'Connected'.
 - IP address does not start with '169'.
 - Netmask, Gateway, and DNS server are present.
- If the IP address starts with 169, check whether your network has a DHCP server running. 99% of all networks have a DHCP server running, and it is enabled by default on all well-known ADSL, cable and mobile routers. If there is no DHCP server running, then configure the IP address manually as described in the [Manual IP configuration \[79\]](#) chapter.
- For a GX GSM or GX LTE 4G, see the [Troubleshooting guide](#) in the GX LTE 4G manual.
- **Ethernet Issues:**
 - If 'State' shows 'Unplugged', check cable and connection indicators on the GX device. The two lights at the back where the Ethernet RJ45 cable plugs in, should be lit or blinking. Two dead lights indicate a connection problem.
- **Wi-Fi Issues:**
 - No WiFi adapter connected!: Reinsert Wi-Fi dongle.
 - When using WiFi and the 'State' shows 'Failure', it might be that the WiFi password is incorrect. Press 'Forget network' and try to connect again with the correct password.

Ethernet	
State	Connected
MAC address	
IP configuration	Automatic >
IP address	192.168.178.108
Netmask	255.255.255.0
Gateway	192.168.178.1
DNS server	192.168.178.1

WiFi	
State	Connected
Name	
Forget network?	Forget
Signal strength	41%
IP configuration	Automatic >
IP address	192.168.178.107
Netmask	255.255.255.0

3. Check the Connection error status

- Navigate to Settings → VRM → 'Connection error':
- If a connection error is displayed, the EGX is unable to communicate with the VRM database. The screen will show an error code indicating the type of connectivity issue, along with additional details to assist on-site IT personnel in diagnosing the problem.
 - **Error #150 Unexpected response text:** The http/https call succeeded, but the response was incorrect. This indicates that there is a WiFi or network login page, sometimes called a "captive portal", occasionally seen in Airports, Hotels, Marinas or RV campgrounds. There is no solution to make the GX device work with a WiFi network that requires such a login page and/or accepting of terms of use.
 - **Error #151 Unexpected HTTP Response:** A connection succeeded, but the response did not indicate a successful HTTP result code (normally 200). This might indicate that a transparent proxy is hijacking the connection. See #150 above for examples.
 - **Error #152 Connection time-out:** This could indicate a poor-quality internet connection or a restrictive firewall.
 - **Error #153 Connection error:** This error may indicate a routing issue. For more information, review the specific error message displayed. In the example below, the GX device was not permitted internet access through the router.
 - **Error #153 Connection problem:** And then specifically an SSL related issue. This error may indicate an SSL-related issue. Check the date, time, and time zone settings on the GX device, as incorrect settings can cause SSL errors. Also, ensure that your router does not display a special disclaimer, login, or acceptance page, which is common on public WiFi networks in places like airports and hotels.
 - **Error #154 DNS Failure:** Make sure that a valid DNS server is configured in the Ethernet or WiFi menu. Typically this is assigned automatically by a DHCP server in a network.
 - **Error #155 Routing error:** VRM is unreachable. This error occurs if an ICMP error is received, indicating that no route exists to the VRM server. Make sure your DHCP server assigns a working default route, or that the gateway is correctly configured for static configurations.
 - **Error #159 Unknown error:** This is a catch-all error for errors that cannot be directly categorised. In such cases the error message will provide information about the problem.

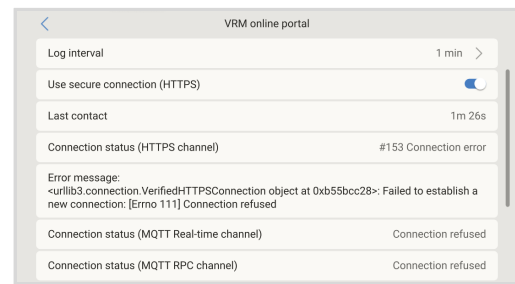
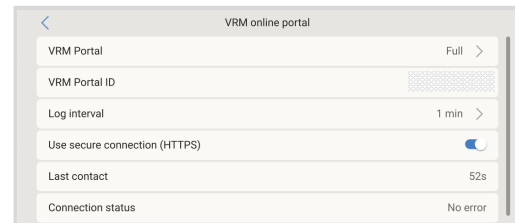

13.5. Analysing data offline (without VRM)

In situations where internet access is unavailable, such as remote installations, data logs can be analysed locally without uploading to the VRM Portal.

1. Install VictronConnect on a Windows or macOS laptop.
2. Insert the USB stick or microSD card containing the data log files from the GX device.
3. Open VictronConnect and use the Venus Log Converter feature to convert the log files into Excel sheets for analysis.

Note: The Venus Log Converter is only available in the Windows and macOS versions of VictronConnect. It is not available on iOS or Android.

For detailed instructions, refer to the [Importing and converting a GX Product Family database File](#) section in the VictronConnect manual.

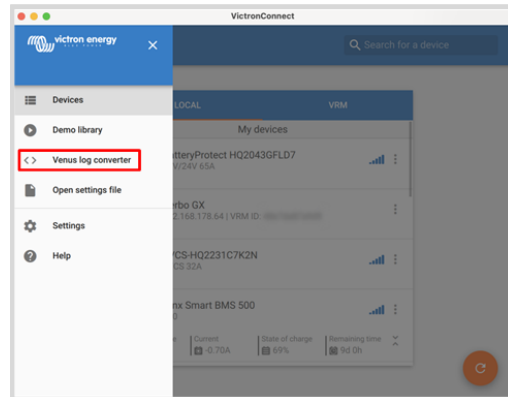

13.6. Access settings for Remote Console & Controls pane in VRM

The level of access to the Remote Console and Controls pane can be configured via the VRM Portal settings menu (Settings → VRM → VRM Portal).

By default, full access is enabled, allowing settings to be modified directly via the Remote Console or the Controls pane on the VRM dashboard. For improved security or to reduce data usage, access can be set to Read-only or Off.

The table below summarises how each setting affects data transmission, real-time mode, the Controls pane, VC-R, and VRM remote firmware updates, helping you choose the appropriate level for your operational requirements.

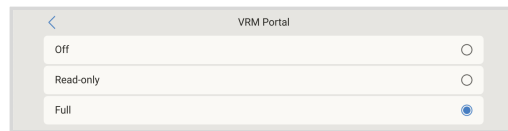

VRM portal option	Normal data transmission	Real-time mode ⁽¹⁾	Controls pane (on the VRM dashboard)	New UI on VRM	Classic UI on VRM	VictronConnect Remote and Remote firmware updates in VRM
Full (default)	Enabled	Enabled	Enabled	Enabled	Enabled ⁽³⁾	Enabled
Read-only	Enabled	Enabled	Disabled	Enabled ⁽²⁾	Disabled	Disabled
Off	Disabled	Disabled	Disabled	Disabled	Disabled	Disabled

⁽¹⁾ Disabling VRM real-time mode can be done on the VRM portal. This can be useful to reduce bandwidth usage on costly connections.

⁽²⁾ Enabled, but it's not possible to change any controls or settings.

⁽³⁾ When the Remote Console feature is Enabled in the GX settings.

13.7. Remote Console on VRM - Troubleshooting

Follow these steps to resolve Remote Console issues on VRM:

1. Confirm VRM portal logging functionality. See [Datalogging to VRM \[121\]](#) and [Troubleshooting data logging \[122\]](#). Without this; Remote Console on VRM will not work.
2. Check that VRM Portal access is set to "Full" or "Read-only" (Settings → VRM → VRM Portal). Refer to [Access settings for Remote Console & Controls pane in VRM \[125\]](#).
3. Update the GX device to the latest firmware version.
4. After restarting, confirm the VRM Online Portal menu connection status shows "No error". If an error persists, review step 3 in the [Troubleshooting data logging \[122\]](#) section.
5. Verify your web browser can access the following URL:
 - <https://ccgxlogging.victronenergy.com/> - A 403 Forbidden or 405 Method Not Allowed error confirms HTTPS connectivity is working correctly.

Click the link to check. Note that seeing an error message means everything is functioning correctly. If you encounter a timeout or any other browser error, there may be a firewall blocking the connection.

14. Marine MFD integration by App

14.1. Introduction & requirements

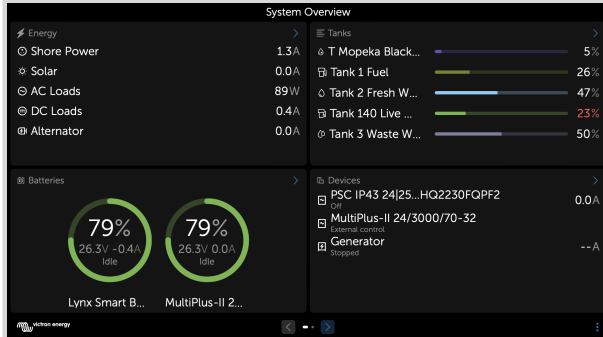

A Glass Bridge is a MFD (Multi-Function Display) that integrates a boat's systems and navigation status into a large screen or screens at the helm of the vessel, so doing away with multiple gauges, brackets and wiring complications.

A Victron system can be easily integrated into a MFD as can be seen in this video:



Functionalities:

- Monitor shore power and generator status.
- Monitor battery status for one or more batteries. By using the voltage of for example battery chargers, it can also visualise secondary batteries such as Generator starter batteries.
- Monitor the power conversion equipment: chargers, inverters, inverter/chargers.
- Monitor solar production from an MPPT Solar Charger.
- Monitor AC loads, and DC loads.
- Monitor tank levels and temperatures
- Control shore power input current limit.
- Control the inverter/charger: switch it off, on, or set it to charger-only.
- Optionally open the Victron Remote Console panel; allowing access to further parameters.

Please note that monitoring and control of AC chargers connected via VE.Direct or VE.Can (this applies to Phoenix IP43 Smart Chargers and the Skylla series) only works when shore power is connected.

Victron equipment compatibility:

- All Victron inverter/chargers: From a 500VA single-phase device up to a large 180kVA three-phase-system, including Multis, Quattros, 230VAC and 120VAC models.
- Battery Monitors: BMV-700, BMV-702, BMV-712, SmartShunt, and newer, Lynx Shunt VE.Can, Lynx Ion BMS, Lynx Smart BMS and Lynx Smart BMS NG.
- All Victron MPPT Solar Charge Controllers
- Temperature sensors and tank senders as far as stated in this manual. See the chapters [Connecting Victron products \[25\]](#) and [Connecting supported non-Victron products \[37\]](#) for supported devices.

Required components:

- Battery system
- Victron GX device (all models are compatible)
- Victron Inverter/charger
- Victron Battery monitor
- Ethernet network cable connected between MFD and the GX device
- MFD specific ethernet adapter cable (only for some brands, see detailed information in below links)

Using the App for other purposes

The app as visible on the MFDs is a HTML5 app hosted on the GX device. It can also be accessed from a regular PC (or mobile device) by navigating a browser to: <http://venus.local/app/>, or replace `venus.local` with the GX IP address.

14.2. Raymarine MFD Integration

14.2.1. Introduction

This chapter explains how to connect to Raymarine MFDs using an Ethernet connection. Also, the last chapter explains the Raymarine specifics when connecting on NMEA 2000.

The integration technology used is called [LightHouse Apps](#) by Raymarine.

Note that there is an alternative method to connect, which is NMEA 2000. For details see the [Marine MFD integration by NMEA 2000 \[143\]](#) chapter.

14.2.2. Compatibility

The MFD integration is compatible with the Axiom, Axiom Pro and Axiom XL MFDs running on LightHouse 3 and Lighthouse 4. The multifunction displays of the eS and gS series that have been upgraded to LightHouse 3 are not compatible.

Raymarine MFDs need at least LightHouse v3.11 for compatibility, which was released in November 2019.

From Victron side, all GX devices can be used and are compatible. For details on detailed product compatibility with regarding to inverter/chargers and other components, see the main [Marine MFD Integration by App \[127\]](#) chapter.

14.2.3. Wiring

The MFD needs to be connected to the GX device using ethernet. It is not possible to connect over WiFi. For the ethernet connection, a RayNet adapter is required.

The RayNet adapters can be purchased from Raymarine:

Raymarine part number	Description
A62360	RayNet (F) to RJ45 (M) - 1m
A80151	RayNet (F) to RJ45 (M) - 3m
A80159	RayNet (F) to RJ45 (M) - 10m
A80247	RayNet (F) to RJ45 (F) Adapter
A80513	RayNet male to RJ45 adaptor cable

To connect the GX device to the internet as well, use WiFi. If the Axiom MFD is connected to internet (using WiFi), it will automatically share its connection with the GX device over ethernet.



Connecting a Axiom MFD to a network router over Ethernet leads to IP address conflicts, due to the integrated DHCP server in the Axiom MFD.



It is not possible to use a GX GSM or GX LTE 4G, due to the integrated DHCP server in the Axiom MFD.



As of Raymarine LightHouse v3.15, there is an option to toggle DHCP. Disabling this option does not mean that the Axiom MFD will work with third party network routers. See [this post on Victron Community](#) for more information.

14.2.4. GX device configuration

1. On the Victron GX device, go to Settings → Integrations, and there enable MQTT Access.
2. Next, go to Settings → System Setup → Batteries → Battery Measurements, and there set up what batteries you want to see on the MFD; and by what name.
3. For boats, RVs and other applications with DC loads such as lighting and a Battery Monitor installed, make sure to enable the "Has DC system setting". For more information about it, see the [Menu structure and configurable parameters \[87\]](#) chapter.

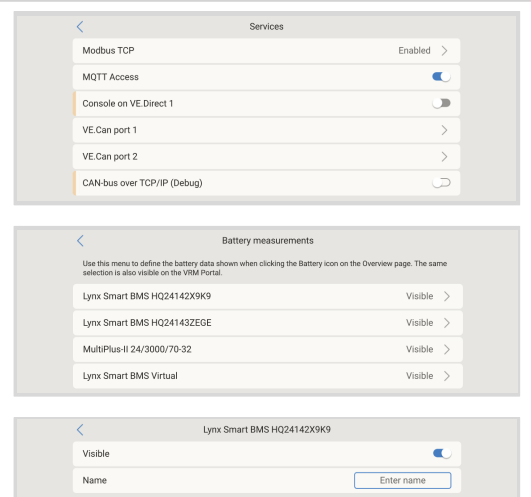

No other settings such as IP addresses or similar are required, since the Axiom MFDs have an integrated DHCP server.

14.2.5. Configuring Multiple Tank Level Measurements (Raymarine)

Modern Raymarine Axiom MFDs are capable of displaying up to 16 tank levels and smaller MFDs such as the i70 or i70s can display up to 5 tanks.

The following restrictions apply:

1. Currently, the Axiom can only display Fuel (default), Fresh Water, Waste Water aka Grey Water, Live Well, Black Water and Gasoline fluid types. The other fluid types such as LNG, LPG, Hydraulic oil and Diesel are not displayed. This is a Raymarine limitation, which may change with a future firmware update.
However, it is possible to configure a specific tank sender's fluid type in the GX device menu to one of the supported ones, and then rename the tank in the Axiom tank settings (Boat Details > Configure Tanks > Tank Settings) to whatever you like, e.g. LPG, which is then displayed as LPG tank on the dashboard.
2. The i70 and i70s will display up to 5 tanks where the fluid type must be Fuel. All other fluid types are not displayed.
3. For instancing requirements, see the [Instancing requirements when using Raymarine \[131\]](#) section further below.
4. All tank senders as mentioned in the chapter [Connecting Victron products \[25\]](#) and [Connecting supported non-Victron products \[37\]](#) are supported.

Configuration step-by-step

Before proceeding with the following steps, you must connect the GX device to the NMEA 2000 network to which the MFD is connected. Use our [VE.Can to NMEA 2000 micro-C male cable](#) to connect the GX device to the NMEA 2000 network and ensure NMEA2000-out of the VE.Can port is enabled in the GX device.

The procedure below does not replace the Raymarine manual; Be sure to read the Raymarine documentation that accompanies your Raymarine MFD. Visit the [Raymarine Manuals and Documents](#) website for the latest version

1. Connect the tank sensors to your GX device.
2. Make sure the tank sensors are set to a fluid type supported by your MFD.

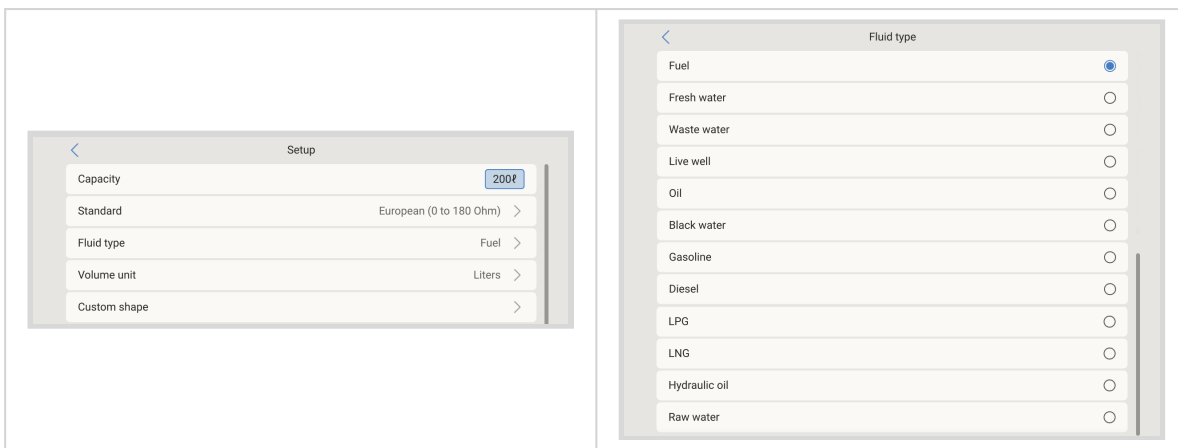

This is done in the setup menu of the tank sensor in the Remote Console - Device List → [your_tank_sensor] → Setup → Fluid type

3. On your Axiom MFD, go to Settings > Boat Details > Tanks > Configure Tanks and verify that all tank sensors are listed.

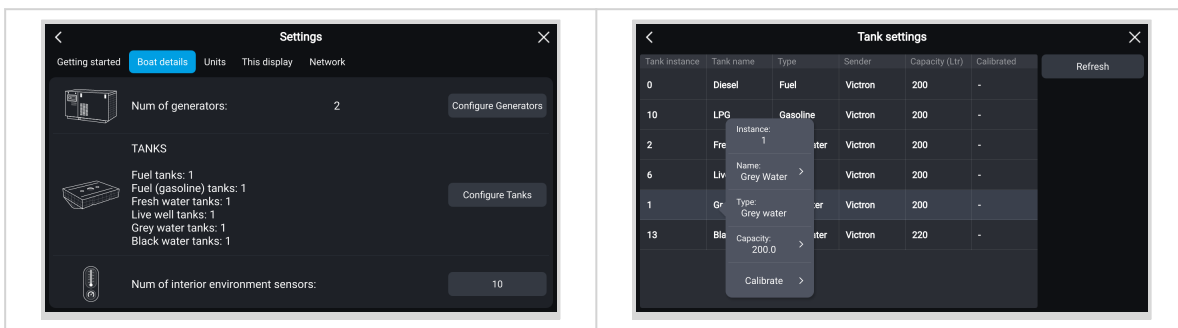

 By briefly tapping on the respective tank, you can change the tank to a meaningful name, which then will be displayed on the dashboard.

4. Open the TANKS dashboard or set up a new page to view the tanks.

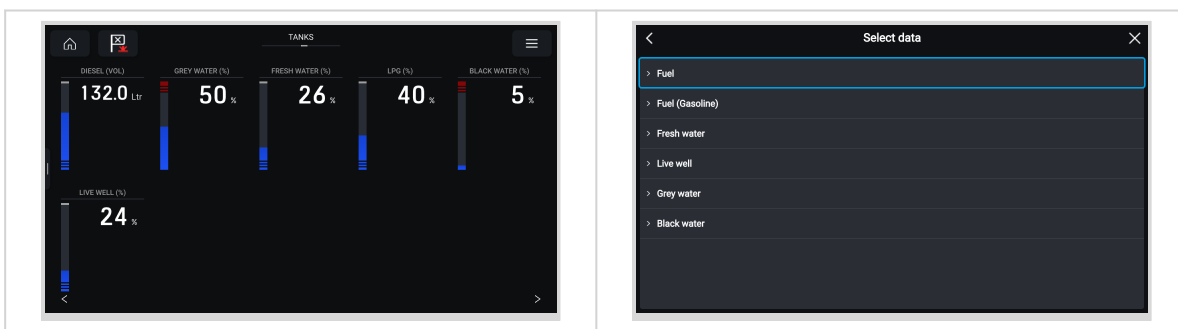

By long tapping on one of the tanks you can make further configurations, e.g. select the tank to be displayed or, if available, change the unit from percent to volume.

14.2.6. Installation step-by-step

1. Connect the RayNet adapter cable to the MFD
2. Connect the RJ45 end of the RayNet adapter cable to the Ethernet port of the GX device
3. On the MFD go to Apps and then select the Victron logo
4. And...you're done. All information can now be viewed on one screen, which is:
DC loads, Battery information, Shore power connection, Solar production, AC loads, Inverter and Generator control and the option to open the Remote Console

This video shows the exact steps:



After connecting the Ethernet cable the GX device, it receives an IP number from the Axiom DHCP. If you start the Victron App on the Axiom and it shows "hardware devices not found", just restart the Axiom and see... it works!

14.2.7. NMEA 2000

Besides connecting over ethernet, a Raymarine MFD can also be connected to the Victron system using NMEA 2000. If you're new to NMEA 2000 & Victron, start with reading the [Marine MFD integration by NMEA 2000 \[143\]](#) chapter.

The below sections explain the specifics of NMEA 2000 when connecting Victron to a Raymarine MFD.

14.2.8. Generic and supported PGNs

To setup the data sources on the Raymarine, go to Settings > Network > Sources > Advanced.

If you have more than 1 battery be sure to adjust the settings of the Axiom to the correct amount of battery(banks).

The following Victron related PGNs are supported by Raymarine:

PGN	Description
127505	Fluid level (tank levels)
127506	DC Detailed Status (State-of-charge, Time-to-go)
127507	Charger status
127508	Battery Status (Battery Voltage, Battery Current)
127509	Inverter status

Note that *J1939 - AC data* is not supported by Raymarine.

When the NMEA 2000/STNG network has GPS data, the GX device sees this as a GPS source and is able to use the GPS position in VRM.

14.2.9. Instancing requirements when using Raymarine

Fluid instancing details:

- Raymarine i70: max number of tank levels is 5; fluid instance 0-4 and type must be fuel
- Raymarine i70s: max number of tank levels is 5; fluid instance 0-4 and type must be fuel
- Axiom MFDs: per Lighthouse version 4.1.75, a maximum of 16 tanks can be connected; fluid instance 0-15

14.2.10. Before LightHouse 4.1.75

If there is more than one ie. SmartShunt in the NMEA 2000 network, or a solar charger and a SmartShunt, or any other device transmitting the same type of PGNs, then the Data instances of these PGNs must be changed to make each Data instance unique.

Typically this concerns the Battery instance, used in the Battery Status and DC Detailed PGNs.

See here for how to do that: [Changing NMEA 2000 Instances](#), section Data instances. This requires an [Actisense NGT-1 NMEA 2000 to PC \(USB\) Interface](#).



This requirement of Data instances being globally unique for a PGN is specific to Raymarine. Other brands do not require this. And, although perhaps besides the point, also the NMEA 2000 standard does not require it. More specifically, it says: "Data instances shall be unique in the same PGNs transmitted by a device. Data instances shall not be globally unique on the network."

14.2.11. LightHouse 4.1.75 and newer

As of LightHouse version 4.1.75, the battery instances no longer need to be unique. This means that you can leave the battery instance to its default value, which is typically set to 0. The batteries are automatically detected by the Axiom display.

14.3. Navico MFD Integration

14.3.1. Introduction

Navico is the overall brand behind the B&G, Simrad and Lowrance MFDs.

This chapter explains how to connect to Navico MFDs using an Ethernet connection.

Make sure to also study the [Marine MFD Integration by App \[127\]](#) chapter.

Note that there is an alternative method to connect, which is NMEA 2000. For details see the [Marine MFD integration by NMEA 2000 \[143\]](#) chapter.

14.3.2. Compatibility

Navico compatible hardware:

Brand	Product	Display Size							Remarks
		7"	9"	10"	12"	16"	19"	24"	
Simrad	NSO EVO3/S					16	19	24	
	NSS EVO3/S	*	9		12	16			NSS7 EVO3 is compatible
	IDS		9		12				
	NSX	7	9		12				Uses a different browser. Not all features are currently supported.
	Go*	7*	9		12				Go5 is not compatible Go7 XSR is compatible while Go7 XSE is not
B&G	Zeus ³ /3S Glass Helm					16	19	24	
	Zeus ³ /3S	*	9		12	16			Zeus ³ 7 is compatible
	Zeus S	7	9		12				Uses a different browser. Not all features are currently supported.
	Vulcan*	7*	9		12				Vulcan 5 is not compatible Vulcan 7R und 7FS are not compatible
Lowrance	HDS Pro		9	10	12	16			
	HDS Live	7	9		12	16			
	HDS Carbon	7	9		12	16			
	Elite FS	7	9						

Note that this feature also works on the Simrad NSS evo2 and B&G Zeus², but only limited. Furthermore, it is not officially supported by Victron or Navico, and there will be no new software versions to fix any problems that may arise. In other words, it is not a supported configuration by Navico.

At the moment, it is not possible to control the Victron MFD App other than via the touch screen. This means that you cannot use:

- Local controls, i.e. WheelKey and arrow keys

- Simrad OP50
- B&G ZC2

14.3.3. Wiring

The Navico device needs to be connected to the GX device using Ethernet. Its not possible to connect over WiFi. For the Ethernet connection, a Navico adapter is required as the Navico MFDs feature a round water proof connector on the back. The adapters can be purchased from Navico:

- ETHADAPT-2M 127-56
- CABLE RJ45M-5F ETH ADPTR NONWATERPRF

14.3.4. GX device configuration

1. On the Victron GX device, go to Settings → Integrations, and there enable MQTT Access.
2. Next, go to Settings → System Setup → Batteries → Battery Measurements, and there set up what batteries you want to see on the MFD; and by what name.
3. For boats, RVs and other applications with DC loads such as lighting and a Battery Monitor installed, make sure to enable the "Has DC system setting". For more information about it, see the [Menu structure and configurable parameters \[87\]](#) chapter.

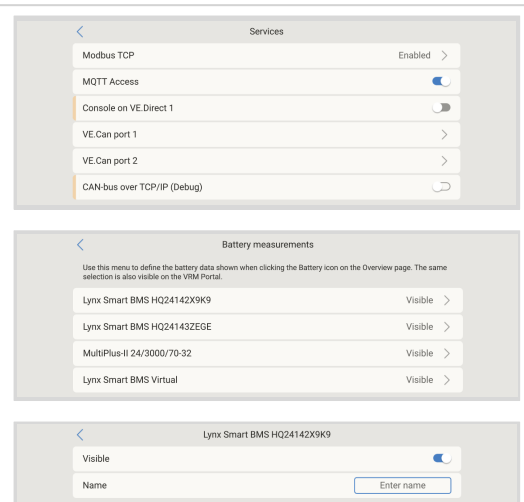

No other settings such as IP addresses or similar are required. The [GX device](#) and the Navico devices connect to each other using a technology called linklocal addressing.

It is possible to connect the router to the same LAN; and that way connect the GX device to the internet. The GX device can also be connected to the internet via WiFi or with a [GX LTE 4G](#).

Note that the GX LTE 4G can only be used if the MFD and GX device are directly connected to each other, without a router.

14.3.5. Configuring Multiple Tank Level Measurements (Navico)

Modern Navico MFDs such as the Simrad NSO EVO3 series are capable of displaying different types of tank levels.

The following restrictions apply:

1. Currently, a compatible Simrad MFD can only display Fuel (default), Water, Waste Water aka Grey Water, Live Well, Oil and Black Water fluid types. The other fluid types such as LNG, LPG and Diesel are not displayed. This is a Simrad limitation, which may change with a future firmware updates of your MFD.
However, it is possible to configure a specific tank sender's fluid type in the GX device menu to one of the supported ones, and then rename the tank in the MFD tank settings to whatever you like, e.g. LPG, which is then displayed as LPG tank on the dashboard.
2. All tank senders as mentioned in the chapter [Connecting Victron products \[25\]](#) and [Connecting supported non-Victron products \[37\]](#) are supported.

Configuration step-by-step

Before proceeding with the following steps, you must connect the GX device to the NMEA 2000 network to which the MFD is connected. Use our [VE.Can to NMEA 2000 micro-C male cable](#) to connect the GX device to the NMEA 2000 network and ensure NMEA2000-out of the VE.Can port is enabled in the GX device.

The procedure below does not replace the Simrad manual; Be sure to read the Simrad documentation that accompanies your MFD; There are some differences in the menu navigation of the various MFDs.

1. Connect the tank sensors to your GX device.
2. Make sure the tank sensors are set to a fluid type supported by your MFD.

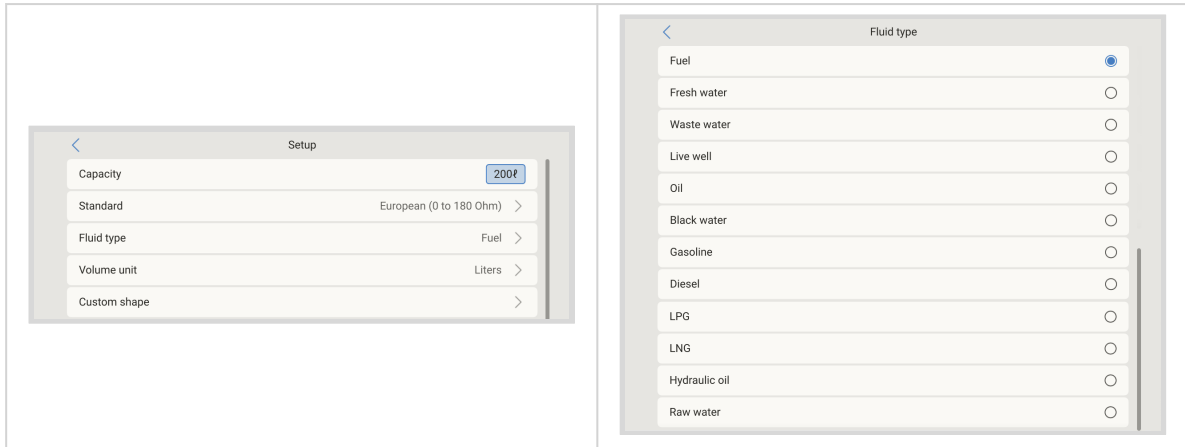

This is done in the setup menu of the tank sensor in the Remote Console - Device List → [your_tank_sensor] → Setup → Fluid type

3. On your Simrad MFD, go to Settings > Network > Sources > Advanced > Data source selection and verify that all tank sensors are listed. The tank sensors should automatically be identified by the system. If not, enable the feature from the advanced option in the System settings dialog.

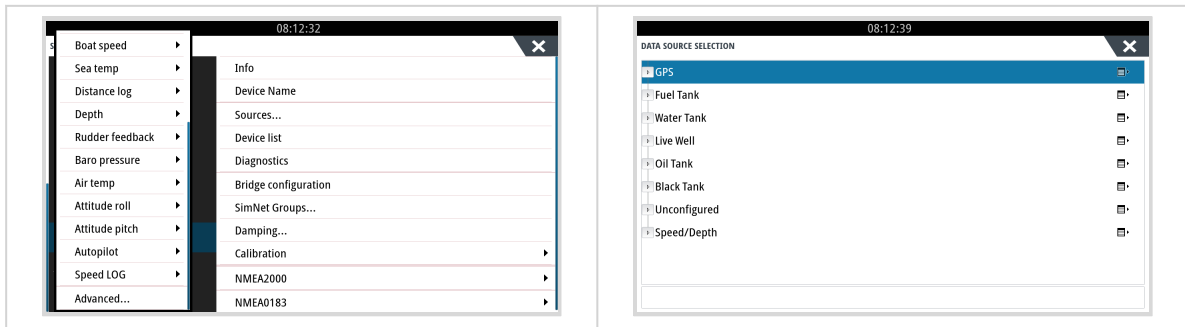

4. Selecting a tank sensor from within the Data source selection menu will bring up additional details and configuration options such as fluid type, location or custom name. Finally, open a dashboard or create a custom dashboard and place the tank sensors as you wish.

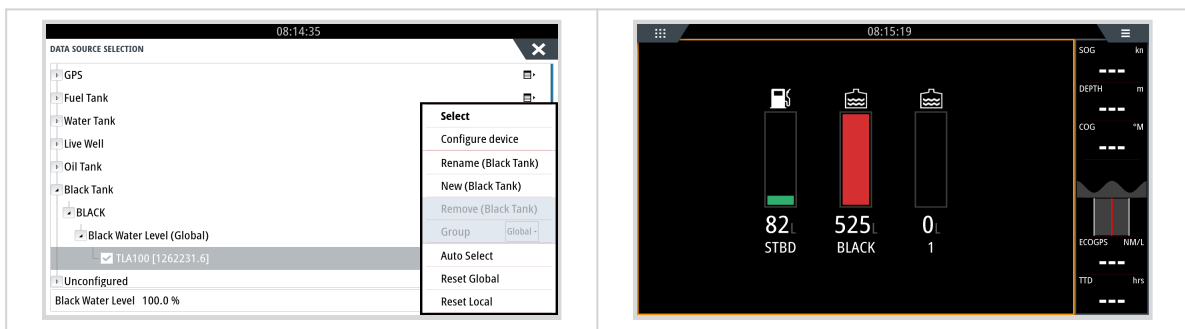

14.3.6. Installation step-by-step

1. Connect the UTP cable to the MFD
2. Connect the other end of the UTP cable to the Ethernet port of the GX device
3. Go to Apps on the MFD and then select the Victron Energy logo, which will appear after a few seconds
4. And...you're done. All information can now be viewed on one screen, which is:

DC loads, Battery information, Shore power connection, Solar production, AC loads, Inverter and Generator control and the option to open the Remote Console

This video shows the exact steps:



14.3.7. NMEA 2000

Besides connecting over ethernet, a Navico MFD can also be connected to the Victron system using NMEA 2000. If you're new to NMEA 2000 & Victron, start with reading the [Marine MFD integration by NMEA 2000 \[143\]](#) chapter.

The MFD can be configured easily to display the data from the GX device. There is no need to change any instance.

To setup the data sources on the MFD, go to Settings > Network > Sources > Advanced.

14.3.8. Generic and supported PGNs

To setup the data sources on the Navico MFD, go to Settings > Network > Sources > Advanced.

The following Victron related PGNs are supported:

PGN	Description
127505	Fluid level (tanks)
127506	DC Detailed Status (State-of-charge, Time-to-go)
127507	Charger status
127508	Battery Status (Battery Voltage, Battery Current)
127509	Inverter status
J1939	AC PGNs

14.3.9. Troubleshooting

Q1: The MFD page shows outdated information or shows the connection issue page, but the GX device is running and connected and the Victron icon is present on the home page.

A1: Try reloading the page by pressing the menu on the top right corner and select HOME.

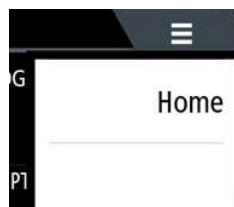

14.4. Garmin MFD Integration

14.4.1. Introduction

This chapter explains how to connect to Garmin MFDs using an Ethernet connection. The integration technology used is called [Garmin OneHelm](#).

Make sure to also study the [Marine MFD Integration by App \[127\]](#) chapter.

Note that there is an alternative method to connect, which is NMEA 2000. For details see the [Marine MFD integration by NMEA 2000 \[143\]](#) chapter.

14.4.2. Compatibility

OneHelm is currently available for the following models:

- GPSMAP® 8400/8600 MFD series
- GPSMAP® 722/922/1222 Plus MFD series

ActiveCaptain is also supported. The screenshot below shows ActiveCaptain with the Victron App.

From Victron side, all GX devices can be used and are compatible. For details on detailed product compatibility regarding inverter/chargers and other components, see the main [Marine MFD Integration by App \[127\]](#) chapter.

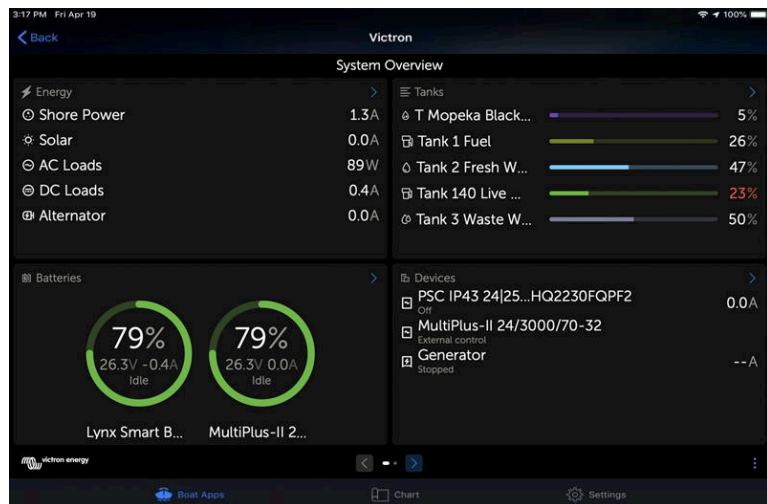

14.4.3. Wiring

The Garmin MFD needs to be connected to the [GX device](#) using Ethernet. Its not possible to connect over WiFi. For the Ethernet connection, a Garmin adapter is required:

Garmin part name	Length	Garmin part number
Garmin Marine Network Cables (Large Connectors)	6ft/1.83m	010-10550-00
Garmin Marine Network Cables (Large Connectors)	20ft/6.1m	010-10551-00
Garmin Marine Network Cables (Large Connectors)	40ft/12.19m	010-10552-00
Garmin Marine Network Cables (Large Connectors)	50ft/15.24m	010-11169-00
Garmin Marine Network Cables (Large Connectors)	500ft/152.4m	010-10647-01
Garmin Marine Network Cable Coupler	N/A	010-10580-00
Garmin Marine Network PoE Isolation Coupler	N/A	010-10580-10

Newer generation Garmin MFDs that are equipped with BlueNet require different cables:

Garmin part name	Length	Garmin part number
Garmin BlueNet™ Network to RJ45 Adapter Cable	N/A	010-12531-02
Garmin BlueNet™ Network Cable (Right Angle)	8"/20.3cm	010-12528-13
Garmin BlueNet™ Network Cable	1ft/0.30m	010-12528-11
Garmin BlueNet™ Network Cable	6ft/1.83m	010-12528-30
Garmin BlueNet™ Network Cable	20ft/6.1m	010-12528-31
Garmin BlueNet™ Network Cable	40ft/12.19m	010-12528-02
Garmin BlueNet™ Network Cable	50ft/15.24m	010-12528-03
Garmin BlueNet™ Network Cable (Right Angle)	50ft/15.24m	010-12528-10

14.4.4. GX device configuration

1. On the Victron GX device, go to Settings → Integrations, and there enable MQTT Access.
2. Next, go to Settings → System Setup → Batteries → Battery Measurements, and there set up what batteries you want to see on the MFD; and by what name.
3. For boats, RVs and other applications with DC loads such as lighting and a Battery Monitor installed, make sure to enable the "Has DC system setting". For more information about it, see the [Menu structure and configurable parameters \[87\]](#) chapter.

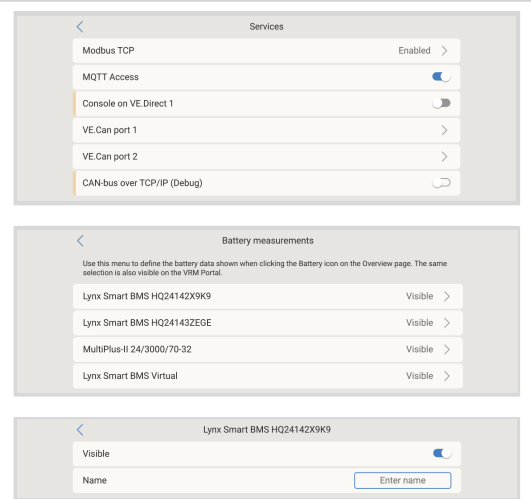

No special networking settings are necessary. Not on the Garmin; and not on the Victron GX device.

The Garmin MFDs run a DHCP server; and the GX device are by default configured to use DHCP. After plugging in the cable, the Victron Energy icon will show up after 10 to 30 seconds.

To connect the GX device to the internet and the [VRM Portal](#) while its Ethernet port is already in use to connect to the Garmin, use WiFi. For more information about it, see the [Internet connectivity \[77\]](#) chapter.



Connecting a Garmin MFD to a network router over Ethernet leads to IP address conflicts, due to the integrated DHCP server.



It is not possible to use a GX GSM or a GX LTE 4G due to the integrated DHCP server of the Garmin MFD.

14.4.5. Configuring Multiple Tank Level Measurements (Garmin)

Modern Garmin MFDs such as the GPSMAP 84xx series are capable of displaying different types of tank levels.

The following restrictions apply:

1. Currently, the GPSMAP can only display Fuel (default), Fresh Water, Waste Water aka Grey Water, Live Well, Oil, Black Water and Generator fluid types. The other fluid types such as LNG, LPG and Diesel are not displayed. This is a Garmin limitation, which may change with a future firmware updates of your MFD.
However, it is possible to configure a specific tank sender's fluid type in the GX device menu to one of the supported ones, and then rename the tank in the GPSMAP tank settings to whatever you like, e.g. LPG, which is then displayed as LPG tank on the dashboard.
2. All tank senders as mentioned in the chapter [Connecting Victron products \[25\]](#) and [Connecting supported non-Victron products \[37\]](#) are supported.

Configuration step-by-step

Before proceeding with the following steps, you must connect the GX device to the NMEA 2000 network to which the MFD is connected. Use our [VE.Can to NMEA 2000 micro-C male cable](#) to connect the GX device to the NMEA 2000 network and ensure NMEA2000-out of the VE.Can port is enabled in the GX device.

The procedure below does not replace the Garmin manual; Be sure to read the Garmin documentation that accompanies your MFD; There are some differences in the menu navigation of the various MFDs.

1. Connect the tank sensors to your GX device.
2. Make sure the tank sensors are set to a fluid type supported by your MFD.

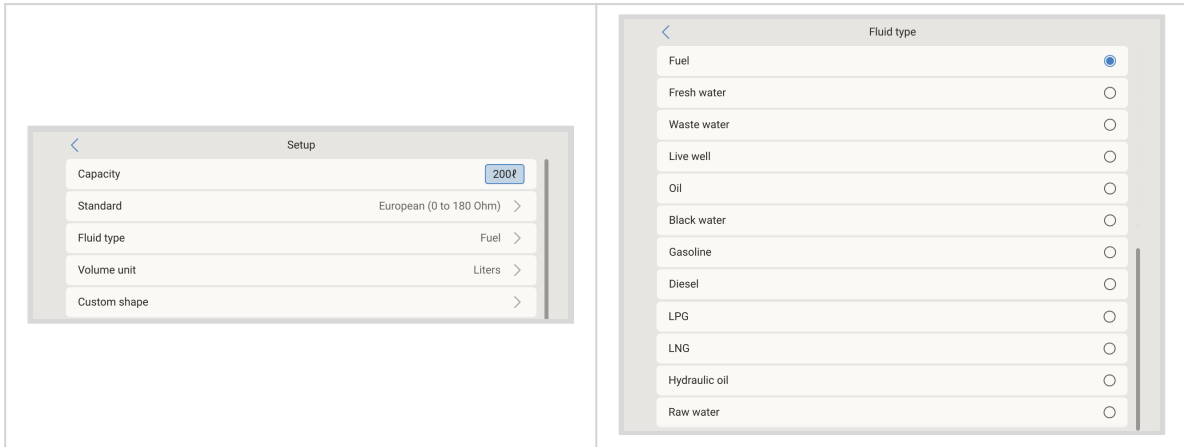

This is done in the setup menu of the tank sensor in the Remote Console - Device List → [your_tank_sensor] → Setup → Fluid type

3. On your Garmin MFD, go to Settings > Communications > NMEA 2000 Setup > Device List and verify that all tank sensors are listed.

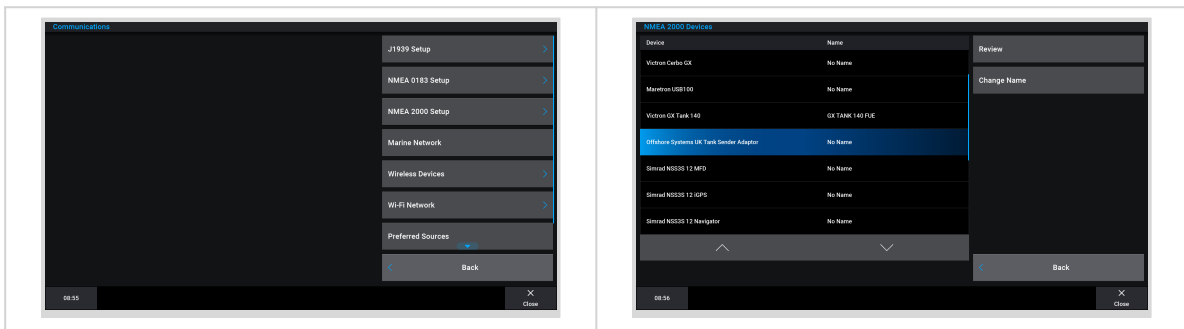

4. Configure the tank level sensors by opening a gauges screen and then select Menu > Tank Preset where you can select a tank level sensor to configure, change the name, type, style, capacity and position of the tank.

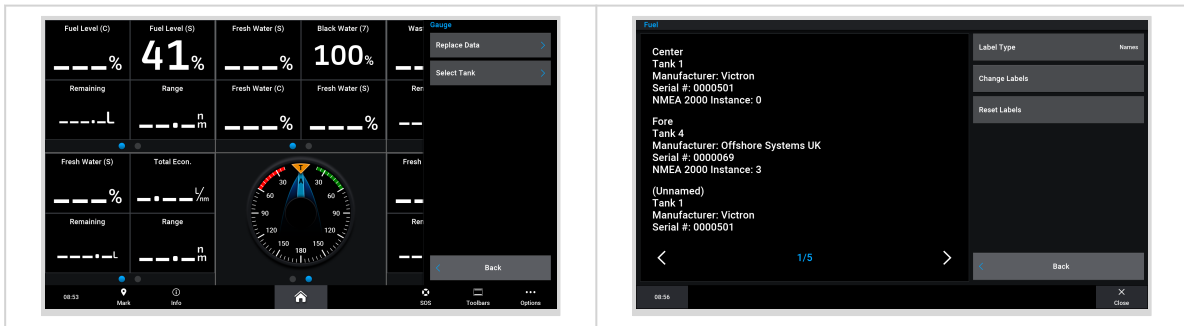

14.4.6. Installation step-by-step

1. Connect the UTP cable to the MFD
2. Connect the other end of the UTP cable to the Ethernet port of the GX device
3. Go to Apps on the MFD and then select the Victron Energy logo, which will appear after a few seconds
4. And...you're done. All information can now be viewed on one screen, which is:
DC loads, Battery information, Shore power connection, Solar production, AC loads, Inverter and Generator control and the option to open the Remote Console

This video shows the exact steps:



14.4.7. NMEA 2000

Besides connecting over ethernet, a Garmin MFD can also be connected to the Victron system using NMEA 2000. If you're new to NMEA 2000 & Victron, start with reading the [Marine MFD integration by NMEA 2000 \[143\]](#) chapter.

The MFD can be configured easily to display the data from the GX device. There is no need to change any instance.

To setup NMEA 2000 on the MFD, go to Settings > Communications > NMEA 2000 Setup > Device List. Here you can view information about the connected products and change their names. Note that the names are stored on the MFD and not on the NMEA 2000 device.

14.4.8. Generic and supported PGNs

The following Victron related PGNs are supported:

PGN	Description
127505	Fluid level (tanks)
127506	DC Detailed Status (State-of-charge, Time-to-go)
127508	Battery Status (Battery Voltage, Battery Current)

The supported PGNs may vary per model. Please consult the manual of the MFD for a list of supported PGNs.

14.5. Furuno MFD Integration

14.5.1. Introduction

This chapter explains how to connect to Furuno MFDs using an Ethernet connection.

Make sure to also study the [Marine MFD Integration by App \[127\]](#) chapter.

Note that there is an alternative method to connect, which is NMEA 2000. For details see the [Marine MFD integration by NMEA 2000 \[143\]](#) chapter. Currently, Furuno MFDs only have support for fluid level PGNs sent out by Victron equipment.

14.5.2. Compatibility

The MFD integration is compatible with the following Furuno MFDs:

- NavNet TZtouch3 TZT12F
- NavNet TZtouch3 TZT16F
- NavNet TZtouch3 TZT19F
- Navnet TZtouch2 TZT2BB Black box

Note that NavNet TZtouch3 MFDs need at least software version v1.08. The Navnet TZtouch2 TZT2BB needs at least software version v7.01.

Also note that the Navnet TZtouch2 TZTL models are not supported.

From Victron side, all GX devices can be used and are compatible. For details on detailed product compatibility with regarding to inverter/chargers and other components, see the main [Marine MFD Integration by App \[127\]](#) chapter.

14.5.3. Wiring

The Furuno device needs to be connected to the GX device using Ethernet. Its not possible to connect over WiFi. For the Ethernet connection, a standard Ethernet cable can be used. The GX device can either be connected directly to the MFD or through a network router/switch.

14.5.4. Configuration

Ethernet configuration

On the Victron GX device, ensure the Ethernet cable is connected, then go to Settings → Connectivity → Ethernet and configure the settings according to the table below:

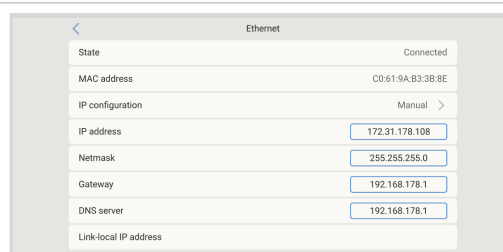

Setting	Value
IP configuration	Manual
IP address	172.31.201.12
Netmask	255.255.0.0
Gateway	0.0.0.0 or the IP address of the router in your network
DNS Server	0.0.0.0 or the IP address of the router in your network

It is possible to connect a router to the same LAN, allowing the GX device to connect to the internet. Ensure that the Gateway and DNS Server settings of the GX device are set to the router's IP address, and that the router's LAN IP address is configured within the same subnet.



It is not possible to use a GX GSM or a GX LTE 4G device.

GX device configuration

1. On the Victron GX device, go to Settings → Integrations, and there enable MQTT Access.
2. Next, go to Settings → System Setup → Batteries → Battery Measurements, and there set up what batteries you want to see on the MFD; and by what name.
3. For boats, RVs and other applications with DC loads such as lighting and a Battery Monitor installed, make sure to enable the "Has DC system setting". For more information about it, see the [Menu structure and configurable parameters \[87\]](#) chapter.

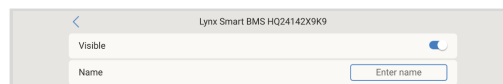
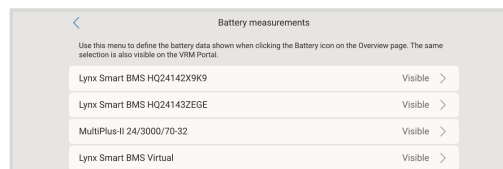

14.5.5. Configuring Multiple Tank Level Measurements (Furuno)

Modern Furuno MFDs such as the NavNet TZtouch3 series are capable of displaying different types of tank levels.

The following restrictions apply:

1. Currently, the NavNet TZtouch3 series can only display Fuel (default), Fresh Water and Black Water with up to 6 tanks for each of the three fluid types.

However, it is possible to change the "Nickname" for each individual tank in the Engine & Tank Manual Setup menu.

2. All tank senders as mentioned in the chapter [Connecting Victron products \[25\]](#) and [Connecting supported non-Victron products \[37\]](#) are supported.

Configuration step-by-step

Before proceeding with the following steps, you must connect the GX device to the NMEA 2000 network to which the MFD is connected. Use our [VE.Can to NMEA 2000 micro-C male cable](#) to connect the GX device to the NMEA 2000 network and ensure NMEA2000-out of the VE.Can port is enabled in the GX device.

The procedure below does not replace the Furuno manual; Be sure to read the Furuno documentation that accompanies your MFD; There are some differences in the menu navigation of the various MFDs.

1. Connect the tank sensors to your GX device.
2. Make sure the tank sensors are set to a fluid type supported by your MFD.

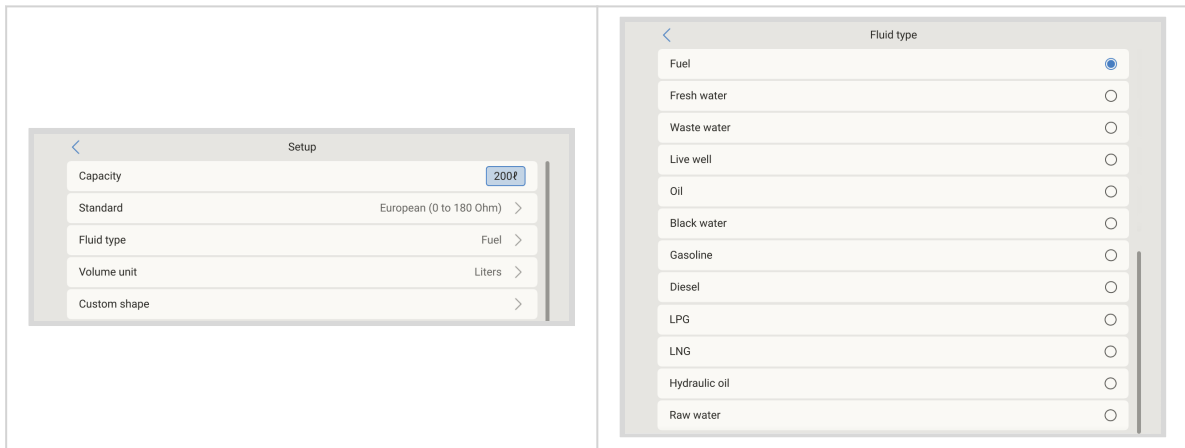

This is done in the setup menu of the tank sensor in the Remote Console - Device List → [your_tank_sensor] → Setup → Fluid type

3. The Furuno MFD will automatically detect tanks connected to the same NMEA 2000 network. If this is not possible (check the Engine & Tank Automatic Setup menu), the tanks can be set manually using the Engine & Tank Manual Setup menu.
4. Set up an "Instrument Display" of your choice and add the respective tanks as an "Indication" (as outlined in the Operator's manual) to the instrument display.

14.5.6. NMEA 2000

Besides connecting over ethernet, a Furuno MFD can also be connected to the Victron system using NMEA 2000. If you're new to NMEA 2000 & Victron, start with reading the [Marine MFD integration by NMEA 2000 \[143\]](#) chapter.

This chapter documents the specifics when displaying Victron NMEA 2000 information on Furuno MFDs. Note that this is not meant to be an extensive guide. It's the simple result of our R&D checking everything on a Furuno MFD. The functionality is (mostly) dictated by Furuno software and may therefore also change and improve when Furuno company changes their software.

The MFD can be configured easily to display the data from the GX device. To display tank data, there is no need to change any instance. In order to properly display Battery/DC data from Victron equipment, you need to change the Data instances of the PGNs that are sent out. See here for how to do that: [Changing NMEA 2000 Instances](#), section Data instances.

To view NMEA 2000 devices on the MFD, go to Settings > Initial Setup > Data Acquisition > Sensor List. Here you can view basic information and change Device instances and custom names.

14.5.7. Generic and supported PGNs

The following Victron related PGNs are supported:

PGN	Description
127505	Fluid level (tanks)
127506	DC Detailed Status (State-of-charge, Time-to-go) ¹⁾
127508	Battery Status (limited support); Voltage, Current ^(1, 2)

¹⁾ The tested Furuno MFD firmware supports a maximum of 4 batteries, no more

²⁾ Due to a bug in the MFD firmware, a negative battery current (ie. when discharging) is shown as --- (three dashes)

15. Marine MFD integration by NMEA 2000

15.1. NMEA 2000 Introduction

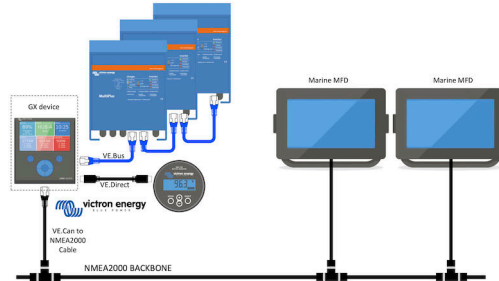

Victron Energy GX devices feature an NMEA 2000-out function: when enabled, the GX device acts as a bridge: it makes all Battery monitors, Inverter/chargers and other products connected to the GX device available on the NMEA 2000 network.

Using that feature, and having the GX device connected a NMEA 2000 network, Marine MFDs can read this data and visualise it to the user. Often in a highly configurable manner.

Use our [VE.Can to NMEA2000 micro-C male cable](#) to connect the GX device to the NMEA 2000 network.

Comparison to the App integration

Compared to MFD integration using the App, as explained in the previous chapter, integration via N2K offers a more customisable configuration. The downside of integration via N2K is that there is more work in making such configuration, as well as making sure all PGNs and fields therein are supported and compatible between the Victron system and the MFD.

More information

Besides this chapter, make sure to also read:

1. [The introduction blogpost](#)
2. Our main [Marine Integration Guide](#)
3. The NMEA 2000 chapter in this manual for the MFD you are using:
 - For Raymarine: [NMEA 2000 \[131\]](#)
 - For Navico: [NMEA 2000 \[135\]](#)
 - For Garmin: [NMEA 2000 \[139\]](#)
 - For Furuno: [NMEA 2000 \[141\]](#)

Yes, that is a lot of reading, but that is basically inherent to NMEA 2000: for example, some of those MFDs support displaying AC data received over the NMEA 2000 wiring, others do not. Some require changing Data instances, others do not, and so forth.

15.2. Supported Devices / PGNs

NMEA 2000 defines several messages.

- Messages are identified by their parameter group number (PGN).
- A textual description of the message is publicly available on the NMEA 2000 website (<http://www.nmea.org/>).
- Detailed specification of the protocol and message definition or part thereof can be ordered online on the NMEA 2000 website.
- NMEA 2000 is based on and compatible with SAE J1939. All AC information messages are in the AC status message format as defined in J1939-75. The specification of these messages can be bought on the SAE website (<http://www.sae.org/>).
- For a detailed list of PGNs, please refer to our [Data communication with Victron Energy products whitepaper](#).

Inverter/chargers

- All inverter/chargers that connect using a VE.Bus port are supported. This includes Multis, Quattros, MultiPlus-IIs, and other (similar) Victron inverter/chargers.

- Data is transmitted out; and its possible to set shore current as well as switch the inverter/charger on and off as well as activate the Inverter only and Charger only modes.

The interface has two functions:

- The function, “153 Inverter”, represents the AC-output
- The function “154 AC Input” monitor represents the AC-input

Charger status messages will be sent by the Inverter function. Both functions have their own network address. Since both functions transmit the same PGNs, for example an AC Status PGN containing voltage, current and more information, NMEA 2000 data consumers like generic displays will need to be able to make a distinction based on the network address. Depending on the function belonging to that network address, the need to interpret it as either Inverter Input or Inverter Output.

- Displays not being capable of doing so will regard the data as belonging to the mains (utility). The Inverter Output is then interpreted as utility #0 and Inverter Input as utility #1. These default instance numbers can be changed by a network configuration tool if necessary.
- Battery temperature, as measured by the inverter(/charger), is transmitted as well.
- All VREG communications need to be sent to the address representing the Inverter function. The other one, AC input, does not support VREG requests: that address only transmits AC information related to the AC input.

Inverters

- Both, the range of inverters connected via VE.Bus as well as our range of inverters connected using a VE.Direct cable, is supported and its information made available on the NMEA 2000 network.

Battery monitors

- Supported. This includes any battery monitor as supported by the GX device.
- The battery selected as the system battery in the GX device (Settings → System Setup → Batteries → Battery monitor) are transmitted with a fixed Device and Battery instance of 239, this to ensure there is always the same instance for the main (system) battery instead of a system using instance 0 for i.e the Lynx Smart BMS (with built-in battery monitor) and a system with i.e. a SmartShunt using different instances.

Solar chargers

- Supported. Battery related values as well as the PV Array Voltage & Current is made available on the NMEA 2000 network.

AC chargers

- Smart IP43 Charger 120-240V and 230V models are supported. Only the 120-240V model allows to be remotely controlled (on/off and input current limit) from a compatible MFD.

Orion XS DC-DC Battery Chargers

- Orion XS devices are supported and can be remotely controlled (on/off) from a compatible MFD.

Tank level data

- All tank levels visible on the GX device, including GX Tank 140 and Mopeka sensors, are transmitted onto the NMEA 2000 network. The used PGN is 127505 Fluid Level, which includes Fluid instance (aka Data instance), Fluid type (Fuel, Fresh Water, Waste Water, Live Well, Oil, Black Water, Gadoline, Diesel, LPG, LNG, Hydraulic oil and Raw Water) and Fluid level as percentage of tank capacity and tank capacity.

Be careful when using the fluid types LNG, LPG, Diesel and Hydraulic oil: these are relatively new types in the NMEA 2000 standard and not all MFDs and chartplotters support them yet.

- Labelling of the tanks on the MFDs needs to be done on each MFD itself. The custom name as configured in the Victron system is transmitted in the field Installation description #1 in the PGN 126996 - Product Information, but not used by the MFDs.
- The GX device automatically numbers each tank with a unique Device instance and Tank instance. They are made the same. This automatic numbering is done specifically and only for tank levels to make the process of showing them properly on all different brands and types of MFDs as simply as possible.

Other data and product types

- Not supported. Above explicitly mentioned types are the only ones now supported.

15.3. NMEA 2000 Configuration

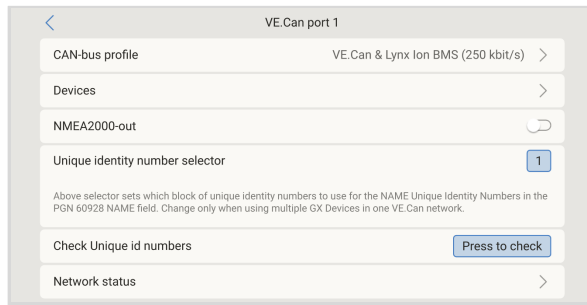

Setting	Default	Description
CAN-bus Profile	VE.Can	Defines the type & baudrate of the CAN-bus network. To use in combination with NMEA 2000, make sure to choose one of the profiles that include VE.Can and is at 250kbit/s
NMEA2000-out	Off	Enables and disables the NMEA2000-out function
Unique identity number selector	1	Selects the block of numbers to use for the NAME Unique Identity Numbers in the PGN 60928 NAME field. For the GX device itself, and when NMEA2000-out is enabled, also for the virtual-devices. Change it only when installing multiple GX devices in the same VE.Can network. There are no other reasons to change this number. For more details regarding the Unique Identity Number, read the last section in this chapter.
Check unique id numbers		Searches for other devices that use the same unique number. When the search is completed, it will respond with either an OK, or the text : <i>There is another device connected with this unique number, please select another one.</i> Note that there is normally no reason to use this function: the GX device automatically and continuously checks uniqueness of the numbers in use and will warn in case there is a conflict. This setting is made available to quickly confirm that everything is OK after changing the setting.

15.4. Configuring Multiple Tank Level Measurements (Raymarine)

Modern Raymarine Axiom MFDs are capable of displaying up to 16 tank levels and smaller MFDs such as the i70 or i70s can display up to 5 tanks.

The following restrictions apply:

1. Currently, the Axiom can only display Fuel (default), Fresh Water, Waste Water aka Grey Water, Live Well, Black Water and Gasoline fluid types. The other fluid types such as LNG, LPG, Hydraulic oil and Diesel are not displayed. This is a Raymarine limitation, which may change with a future firmware update.

However, it is possible to configure a specific tank sender's fluid type in the GX device menu to one of the supported ones, and then rename the tank in the Axiom tank settings (Boat Details > Configure Tanks > Tank Settings) to whatever you like, e.g. LPG, which is then displayed as LPG tank on the dashboard.

2. The i70 and i70s will display up to 5 tanks where the fluid type must be Fuel. All other fluid types are not displayed.
3. For instancing requirements, see the [Instancing requirements when using Raymarine \[131\]](#) section further below.
4. All tank senders as mentioned in the chapter [Connecting Victron products \[25\]](#) and [Connecting supported non-Victron products \[37\]](#) are supported.

Configuration step-by-step

Before proceeding with the following steps, you must connect the GX device to the NMEA 2000 network to which the MFD is connected. Use our [VE.Can to NMEA 2000 micro-C male cable](#) to connect the GX device to the NMEA 2000 network and ensure NMEA2000-out of the VE.Can port is enabled in the GX device.

The procedure below does not replace the Raymarine manual; Be sure to read the Raymarine documentation that accompanies your Raymarine MFD. Visit the [Raymarine Manuals and Documents](#) website for the latest version

1. Connect the tank sensors to your GX device.
2. Make sure the tank sensors are set to a fluid type supported by your MFD.

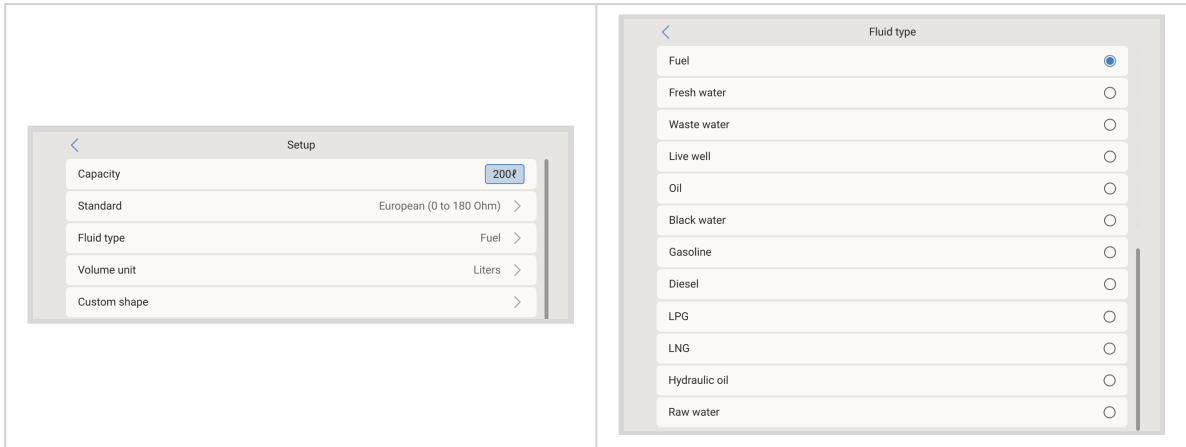

This is done in the setup menu of the tank sensor in the Remote Console - Device List → [your_tank_sensor] → Setup → Fluid type

3. On your Axiom MFD, go to Settings > Boat Details > Tanks > Configure Tanks and verify that all tank sensors are listed.

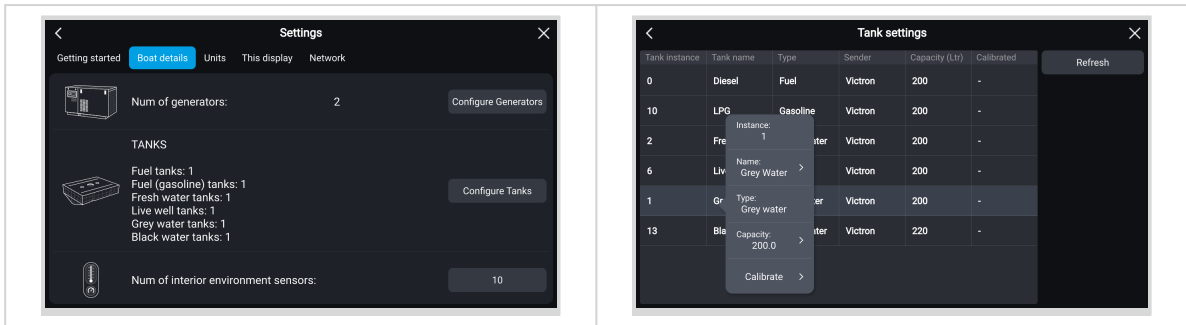

 By briefly tapping on the respective tank, you can change the tank to a meaningful name, which then will be displayed on the dashboard.

4. Open the TANKS dashboard or set up a new page to view the tanks.

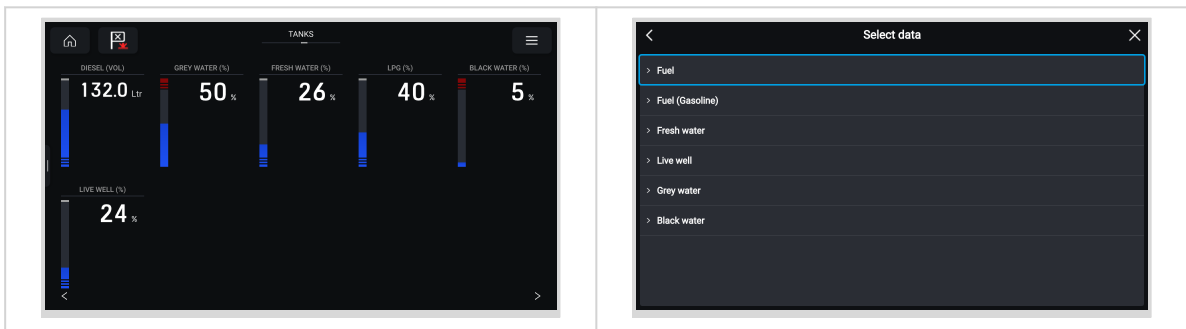

By long tapping on one of the tanks you can make further configurations, e.g. select the tank to be displayed or, if available, change the unit from percent to volume.

15.5. Configuring Multiple Tank Level Measurements (Garmin)

Modern Garmin MFDs such as the GPSMAP 84xx series are capable of displaying different types of tank levels.

The following restrictions apply:

1. Currently, the GPSMAP can only display Fuel (default), Fresh Water, Waste Water aka Grey Water, Live Well, Oil, Black Water and Generator fluid types. The other fluid types such as LNG, LPG and Diesel are not displayed. This is a Garmin limitation, which may change with a future firmware updates of your MFD.

However, it is possible to configure a specific tank sender's fluid type in the GX device menu to one of the supported ones, and then rename the tank in the GPSMAP tank settings to whatever you like, e.g. LPG, which is then displayed as LPG tank on the dashboard.

- All tank senders as mentioned in the chapter [Connecting Victron products \[25\]](#) and [Connecting supported non-Victron products \[37\]](#) are supported.

Configuration step-by-step

Before proceeding with the following steps, you must connect the GX device to the NMEA 2000 network to which the MFD is connected. Use our [VE.Can to NMEA 2000 micro-C male cable](#) to connect the GX device to the NMEA 2000 network and ensure NMEA2000-out of the VE.Can port is enabled in the GX device.

The procedure below does not replace the Garmin manual; Be sure to read the Garmin documentation that accompanies your MFD; There are some differences in the menu navigation of the various MFDs.

- Connect the tank sensors to your GX device.
- Make sure the tank sensors are set to a fluid type supported by your MFD.

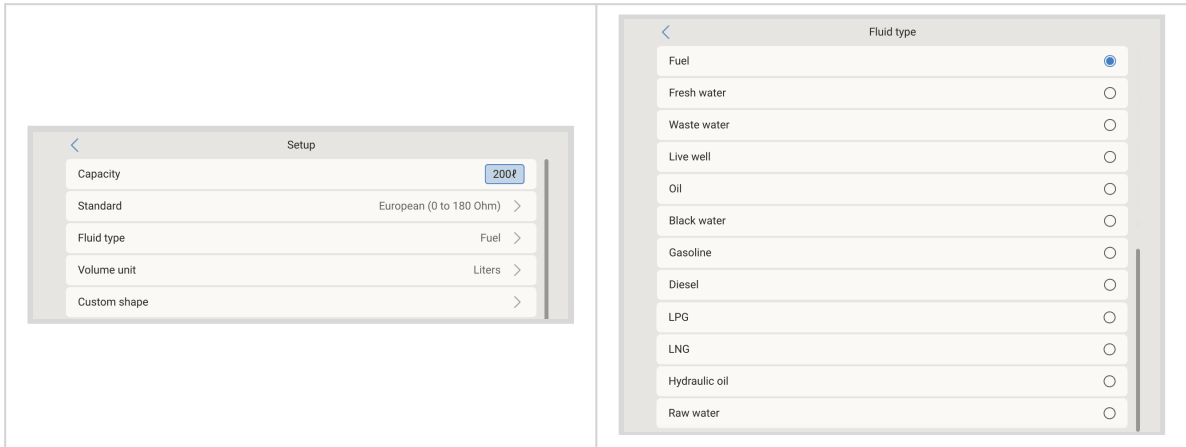

This is done in the setup menu of the tank sensor in the Remote Console - Device List → [your_tank_sensor] → Setup → Fluid type

- On your Garmin MFD, go to Settings > Communications > NMEA 2000 Setup > Device List and verify that all tank sensors are listed.

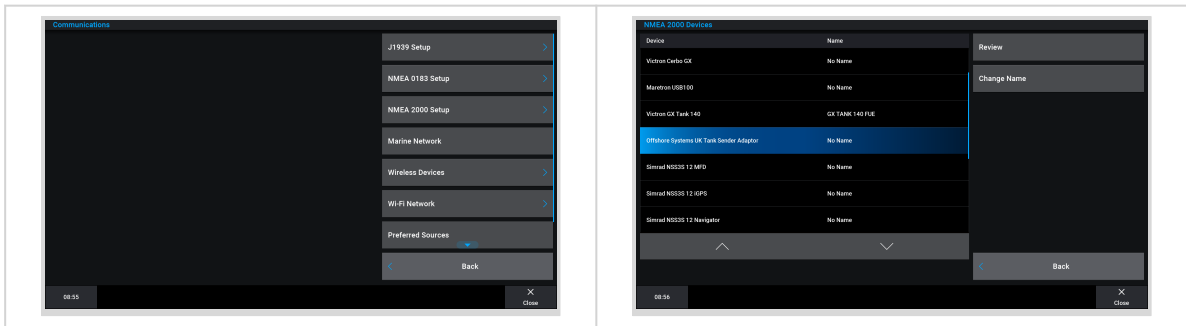

- Configure the tank level sensors by opening a gauges screen and then select Menu > Tank Preset where you can select a tank level sensor to configure, change the name, type, style, capacity and position of the tank.

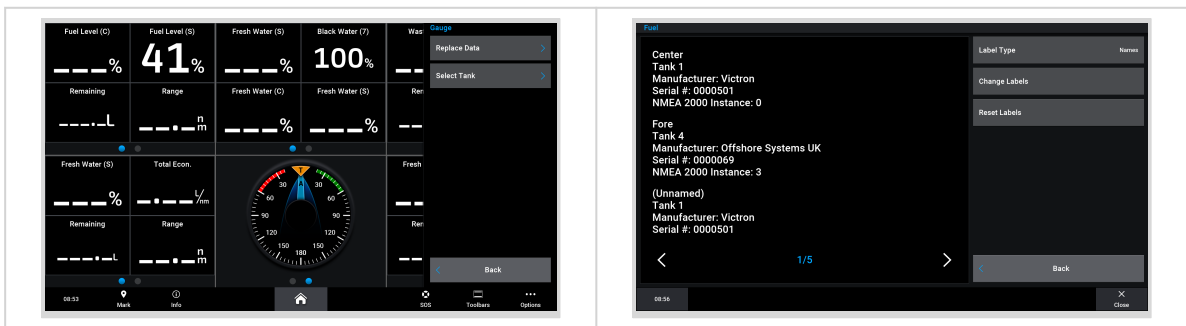

15.6. Configuring Multiple Tank Level Measurements (Navico)

Modern Navico MFDs such as the Simrad NSO EVO3 series are capable of displaying different types of tank levels.

The following restrictions apply:

1. Currently, a compatible Simrad MFD can only display Fuel (default), Water, Waste Water aka Grey Water, Live Well, Oil and Black Water fluid types. The other fluid types such as LNG, LPG and Diesel are not displayed. This is a Simrad limitation, which may change with a future firmware updates of your MFD.

However, it is possible to configure a specific tank sender's fluid type in the GX device menu to one of the supported ones, and then rename the tank in the MFD tank settings to whatever you like, e.g. LPG, which is then displayed as LPG tank on the dashboard.

2. All tank senders as mentioned in the chapter [Connecting Victron products \[25\]](#) and [Connecting supported non-Victron products \[37\]](#) are supported.

Configuration step-by-step

Before proceeding with the following steps, you must connect the GX device to the NMEA 2000 network to which the MFD is connected. Use our [VE.Can to NMEA 2000 micro-C male cable](#) to connect the GX device to the NMEA 2000 network and ensure NMEA2000-out of the VE.Can port is enabled in the GX device.

The procedure below does not replace the Simrad manual; Be sure to read the Simrad documentation that accompanies your MFD; There are some differences in the menu navigation of the various MFDs.

1. Connect the tank sensors to your GX device.
2. Make sure the tank sensors are set to a fluid type supported by your MFD.

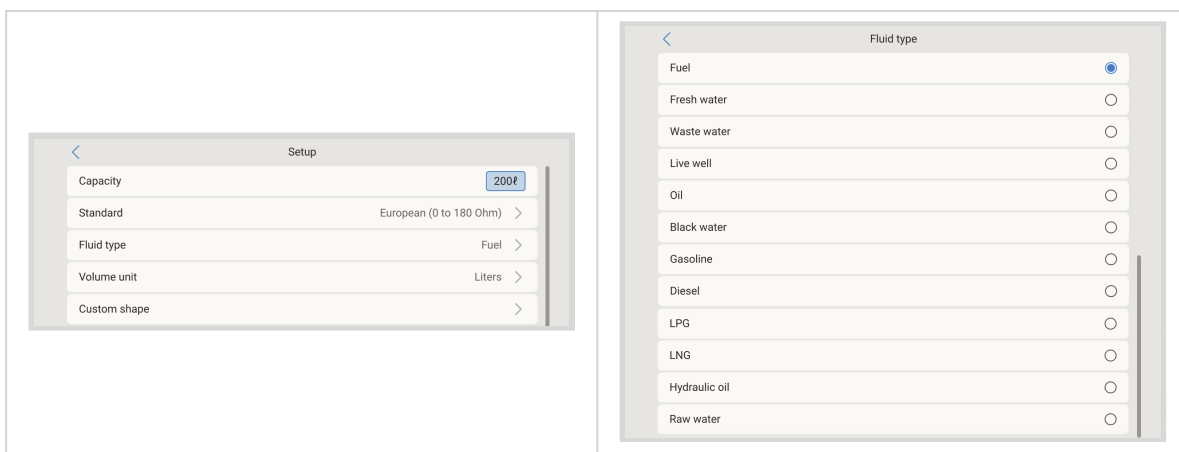

This is done in the setup menu of the tank sensor in the Remote Console - Device List → [your_tank_sensor] → Setup → Fluid type

3. On your Simrad MFD, go to Settings > Network > Sources > Advanced > Data source selection and verify that all tank sensors are listed. The tank sensors should automatically be identified by the system. If not, enable the feature from the advanced option in the System settings dialog.

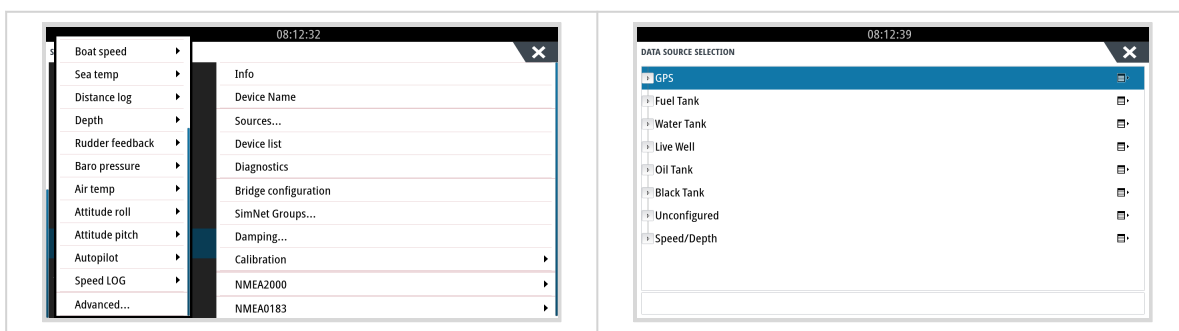

4. Selecting a tank sensor from within the Data source selection menu will bring up additional details and configuration options such as fluid type, location or custom name. Finally, open a dashboard or create a custom dashboard and place the tank sensors as you wish.

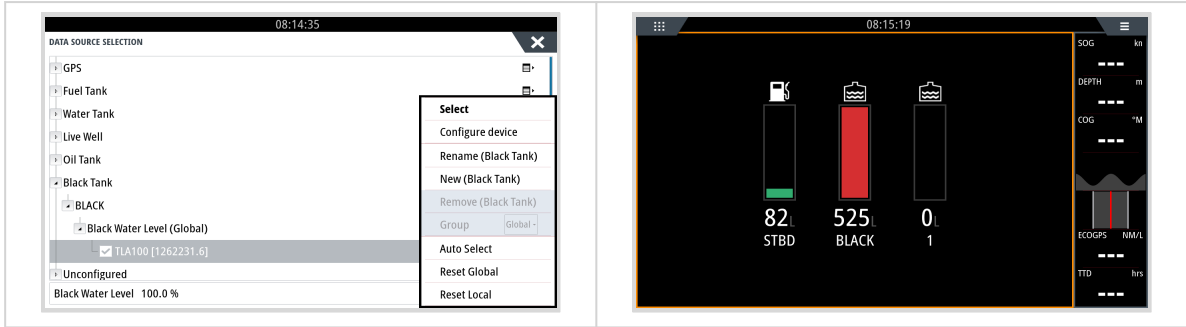

15.7. Configuring Multiple Tank Level Measurements (Furuno)

Modern Furuno MFDs such as the NavNet TZtouch3 series are capable of displaying different types of tank levels.

The following restrictions apply:

1. Currently, the NavNet TZtouch3 series can only display Fuel (default), Fresh Water and Black Water with up to 6 tanks for each of the three fluid types.

However, it is possible to change the "Nickname" for each individual tank in the Engine & Tank Manual Setup menu.

2. All tank senders as mentioned in the chapter [Connecting Victron products \[25\]](#) and [Connecting supported non-Victron products \[37\]](#) are supported.

Configuration step-by-step

Before proceeding with the following steps, you must connect the GX device to the NMEA 2000 network to which the MFD is connected. Use our [VE.Can to NMEA 2000 micro-C male cable](#) to connect the GX device to the NMEA 2000 network and ensure NMEA2000-out of the VE.Can port is enabled in the GX device.

The procedure below does not replace the Furuno manual; Be sure to read the Furuno documentation that accompanies your MFD; There are some differences in the menu navigation of the various MFDs.

1. Connect the tank sensors to your GX device.
2. Make sure the tank sensors are set to a fluid type supported by your MFD.

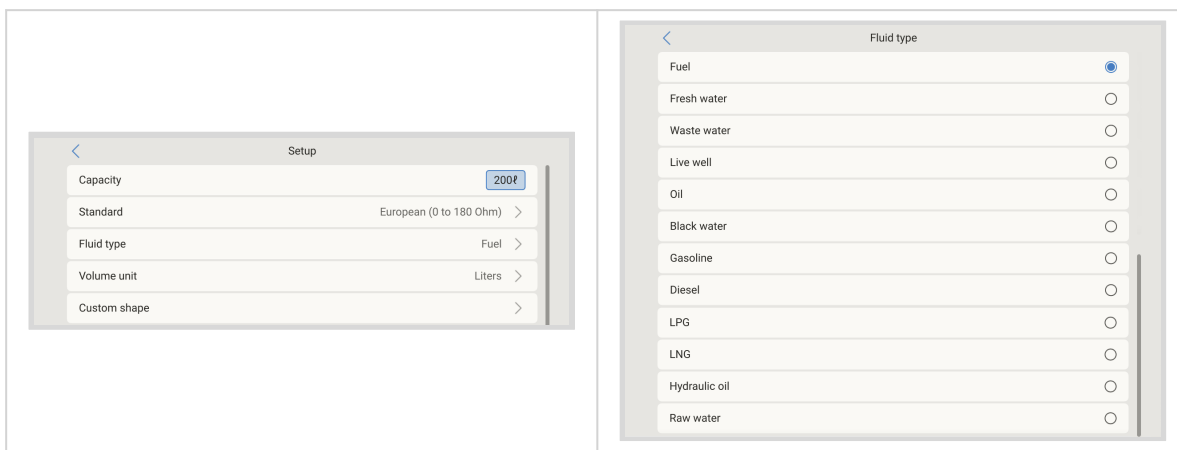

This is done in the setup menu of the tank sensor in the Remote Console - Device List → [your_tank_sensor] → Setup → Fluid type

3. The Furuno MFD will automatically detect tanks connected to the same NMEA 2000 network. If this is not possible (check the Engine & Tank Automatic Setup menu), the tanks can be set manually using the Engine & Tank Manual Setup menu.
4. Set up an "Instrument Display" of your choice and add the respective tanks as an "Indication" (as outlined in the Operator's manual) to the instrument display.

15.8. NMEA2000-out technical details

15.8.1. NMEA 2000 Glossary

Here is a glossary to help with the interpretation of this text:

- **Virtual-device:** a Battery Monitor, Inverter, or other Victron device that does not have a CAN-bus port by itself, made available "virtually" on the CAN-bus by the NMEA2000-out function of the GX device.
- **CAN-bus:** the VE.Can port on the GX device, that, in the context of this chapter, is most likely connected to a NMEA 2000 network.
- **NMEA2000-out:** the software feature in the GX device, which is described in this chapter.
- **NMEA 2000:** Marine CAN-bus protocol, based on J1939.
- **Instance:** there are many types of instances, and explained in detail below.
- **J1939:** A set of standards defining a CAN-bus protocol, defined by the SAE organisation.

- **Address Claim procedure (ACL):** a mechanism, specified by J1939 and used in NMEA 2000 by devices on the network to negotiate and assign each device on the network a unique network addresses. It is a number from 0 to 252. There are three special network addresses defined:
 1. 0xFD (253) - Reserved
 2. 0xFE (254) - Unable to claim address - for example when all others are in use
 3. 0xFF (255) - The broadcast address

15.8.2. NMEA 2000 Virtual-devices

When the NMEA2000-out feature is enabled, the GX device acts as a bridge: it will make each Battery monitor, Inverter/charger or other device that is connected available individually on the CAN-bus. Individually, as in each with its own network address, its own Device instance, function codes, and so forth.

For example, a GX device with two BMVs connected on a VE.Direct port and an inverter/charger connected using VE.Bus, will make the following data available on the CAN-bus:

Address	Class	Function	Description
0xE1	130 (Display)	120 (Display)	The GX device itself
0x03	35 (Electrical generation)	170 (Battery)	The 1st BMV
0xE4	35 (Electrical generation)	170 (Battery)	The 2nd BMV
0xD3	35 (Electrical generation)	153	The inverter/charger (AC-output)
0xD6	35 (Electrical generation)	154	The inverter/charger (AC-input)

15.8.3. NMEA 2000 Classes and Functions

As per NMEA 2000 specification, these define the types of senders and devices connected to the CAN-bus. Classes are the main categories and functions specify it to a further detail.

15.8.4. NMEA 2000 Instances

Instances are used in an NMEA 2000 network to identify multiple similar products connected to the same network.

As an example, take a system with two battery monitors (one for the main battery bank, and another for the hydraulic-thruster bank) and also a Quattro inverter/charger. All three of those devices will send their battery voltage measurements out on the N2K network. For the displays to show these values at the right place, they need to know which voltage belongs to what battery. That is what instances are for.

There are various types of instances, and for marine systems are two that matter: the Device instance and the Data instance. The Data instance goes by various different names, like Fluid instance, Battery instance and DC instance. NMEA 2000 defines three different instances:

1. **Data instance**
2. **Device instance**
3. **System instance**

For all battery monitors and other devices that the GX device makes available on the CAN-bus, each of the above types of instances is available and can be individually configured.

Per Virtual-device, there is one Device instance and one System instance. And depending on the type of Virtual-device, there are one or multiple Data instances.

For example, for a BMV-712 there are two Data instances, one DC Instance for the main battery and another one for the Starter battery voltage.

How to configure the instances depends on the equipment and software that is used to read them from the CAN-bus. Examples of equipment and software meant here are MFDs such as from Garmin, Raymarine, Furuno or Navico; as well as more software-oriented solutions from for example Actisense and Maretron.

Most of those solutions identify parameters and products by requiring unique Device instances, or using the PGN 60928 NAME Unique Identity Numbers and do not rely on the Data instances to be globally unique.

However, there is one exception:

- Raymarine MFDs may need to change the Data instance to display data properly, depending on the Lighthouse firmware version. For more information, please see the Raymarine-specific [NMEA 2000 \[131\]](#) chapter.

The NMEA 2000 specification specifies the following: "Data instances shall be unique in the same PGNs transmitted by a device. Data instances shall not be globally unique on the network. Field programmability shall be implemented through the use of PGN 126208, Write Fields Group Function."

In other words, Data instances need to be unique only within a single device. There is no requirement for them to be globally unique – the only exception is "Engine Instance" which at least for now, to cope with legacy devices, needs to be globally unique (e.g. Port = 0, Starboard = 1). For example, some of our BMV battery monitors can measure two voltages, one for the main battery and one for the starter battery, and that's where data instancing is used. Similar for multiple-output battery chargers. Note that there is no need for the installer to change those data instances, as those products are pre-configured to transmit the relevant PGNs with unique Data instances (Battery instance & DC Detailed instance, in this case).



Whilst it is possible to change the Data instances, changing them on a Victron device such as the Skylla-i battery charger will render that device impossible to read correctly by other Victron devices.

This is because the GX device expects the charger's output one to be on Battery & DC instance 0, output two on Battery & DC instance 1, and output three on Battery & DC instance 2. Changing the fluid instance, as well as other data instances for PGNs transmitted by a GX device on an NMEA 2000 network using its NMEA2000-out feature, is no problem.

A note about the Device instances: it is not necessary to assign a unique Device instance to each device on the CAN-bus. It's no problem for a battery monitor and a solar charger to both be configured with (their default) Device instance 0. Also when having multiple battery monitors or solar chargers, it is not always necessary to assign each of them a unique Device instance. If at all necessary, they only need to be unique between the devices that use the same Function.

And note that changing the Device instance on a Victron device can change its operation, see the warning above.

System instances

As per NMEA 2000 specification, this instance is a 4-bit field with a valid range from 0 to 15 that indicates the occurrence of devices in additional network segments, redundant or parallel networks, or sub networks.

The System Instance Field can be utilised to facilitate multiple NMEA 2000 networks on these larger marine platforms. NMEA 2000 devices behind a bridge, router, gateway, or as part of some network segment could all indicate this by use and application of the System Instance Field.

The ECU instance and Function instance

In some documentation and software tools, yet other terminology is used:

- ECU Instance
- Function Instance
- Device Instance Lower
- Device Instance Upper

Here is how they all relate: the *ECU Instance* and *Function Instance* terminology originates from the SAE J1939 and ISO 11783-5 specification. And they do not exist in the NMEA 2000 definition. However, they all do define the same fields in the same CAN-bus messages which NMEA 2000 defines as *Device instance*.

In more detail: The field that J1939 defines as ECU Instance is in the NMEA 2000 specification renamed to *Device Instance lower*. The Function Instance is renamed to *Device Instance Upper*. And together they form the *Device Instance*, an NMEA 2000 definition.

While using different terms, those fields are the same fields in both standards. Device Instance Lower being 3 bits in length, and Device Instance Upper 5, together 8 bits. Which is the one byte being the NMEA 2000 Device Instance.

The Unique Instance

The *Unique Instance* is one more word used to describe almost the same information. It's used by Maretron and can be made visible in their software by enabling the column. The Maretron software itself chooses between Device Instance and Data Instance.

15.8.5. NMEA 2000 Changing Instances

As the NMEA 2000 protocol prescribes commands to change an instance by sending commands to a device, there are various ways of changing instances. The most commonly used methods are described below. In addition to the methods described here, there are others, for example, some MFDs also allow instances to be modified.

Commonly used methods to change instances:

1. Remote Console on a GX device: Device instances only

2. Actisense NMEA-Reader software + NGT-1 USB: Device and Data instances
3. Maretron software + USB adapter: Unknown (see Maretron documentation)
4. Commandline of a GX device: Device and Data instances. Note that this required advanced Linux skills; and is listed here only for the benefit of experienced software developers

Notes on changing Data and Device instances

• Data instance:

Even though we recommend not changing Data instances (see the explanation and WARNING above), it is possible to change them.

The GX device has no option to change them - a third-party tool is required. The only tool we are aware of that can perform this function is the Actisense NMEA 2000 Reader.

- The Battery instance and the DC instance are the same value within Victron products. Changing one of them, will also change the other one.
- Since the BMV sends out two voltages, the main voltage and the aux- or starter-voltage, it comes preconfigured with two battery instances: 0 and 1. When you want to change that to 1 and 2, change the 1 into 2 first, and then the 0 into 1, as they cannot be the same.
- Since Solar Chargers send two sets of voltage and current data (one for the battery charging output and one for the solar input), these are configured by default as Data instance 0 for the battery charging output and Data instance 1 for the solar input. The device type is set to Battery for the charging output and Solar Cell for the solar input.
- Since Orion XS DC-DC battery chargers send two sets of voltage and current data (one for the output and one for the input), these are configured by default as Data instance 0 for the output and Data instance 1 for the input. The device type is set to Battery for the output and Converter for the input.
- AC chargers can send up to three instances of voltage and current data, one for each battery charging output. By default, these are configured as Instance 0 for output 1, Instance 1 for output 2, and Instance 2 for output 3.
- Changing the fluid level instance using Actisense has a bug. Probably due Actisense seeing it as 8 bit number; while in the definition it is a 4 bit number. Work around: using the GX, set the fluid type to Fuel (0), then using Actisense change the fluid instance to the desired value, and then using your GX, set the type back to the desired type.

• Device instance:

WARNING: these (Victron-)features depend on the Device instance:

1. For an [ESS system](#) with Solar chargers connected to a VE.Can network, those Solar chargers must remain to be configured to their default Device instance (0) for proper operation. This does not apply to VE.Direct-connected Solar chargers made available on the CAN-Bus as a Virtual-device, using the NMEA 2000-out function. Unless the Device instance of the GX device is re-configured to another Device instance. Which is technically possible but not advised and also never required. But in that situation, the chargers must be configured to the same instance as the GX device.
2. For systems with managed batteries, the same.
3. For both, Solar chargers, as well as AC-connected battery chargers, when connected in a VE.Can network, they will synchronise their operation, charge state and such. All chargers must be configured to the same Device instance for that function to work.

In summary, for most systems, we recommend leaving the Device instance to its default, 0.

Remote Console on a GX device: Changing the Device instance:

The VE.Can devices submenu provides access to a list of all devices detected on the VE.Can / NMEA 2000 network.

- Each entry first shows the name, either the product name from our database or, if configured, the custom name set during installation.
- Between the square brackets, the Unique Identity Number is shown.
- On the right, the VE.Can Device Instance is shown, which is the same as the NMEA 2000 Device Instance.

Click or tap to select the device for which you want to change the Device Instance. The configuration menu will open. From there, click or tap on 'VE.Can Device Instance' to make the change.

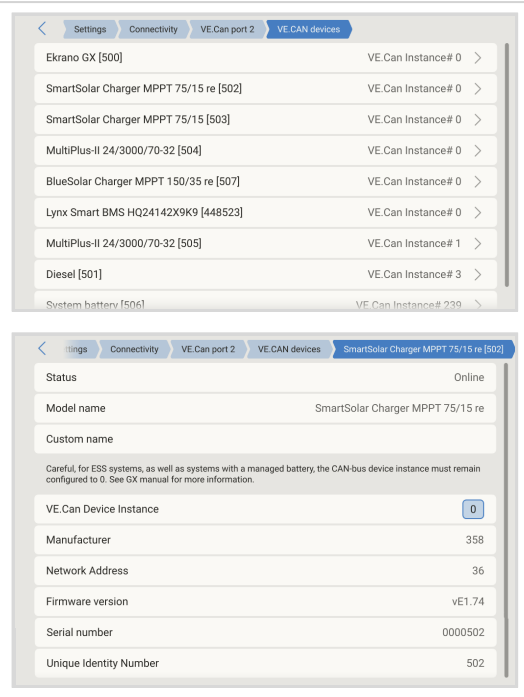

Actisense: Changing Device instances:

Requires the [Actisense NGT-1](#).

To change a Device instance:

1. Open Actisense NMEA Reader
2. Select the network view (tab selection is at the bottom left)
3. Select the product whose Device instance you want to change
4. Select the properties tab at the bottom right and change the Device instance

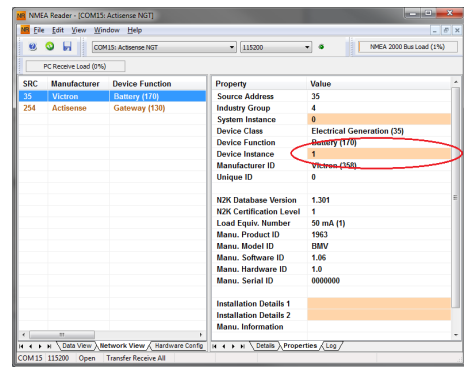

Actisense: Changing Data instances:

Requires the [Actisense NGT-1](#).

To change a Data instance:

1. Open Actisense NMEA Reader
2. Select data view (tab selection is at the bottom left)
3. Right click on the PGN number
Note that this will only work on PGNs that allow changing their Data instance (first screenshot below)
4. And change the value (second screenshot below)

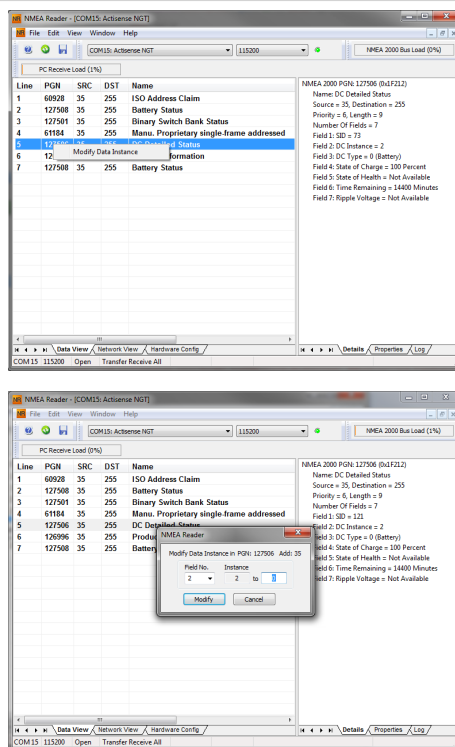

Maretron N2KAnalyzer:

Maretron uses a term called “Unique Instance” where the N2KAnalyzer software tool automatically determines if a particular device uses Device or Data instances.

! **WARNING:** At Victron we do not understand what and how the Maretron software works with regards to this. We advise to use another tool, not Maretron, so that you know what you are doing, ie know what instance you are changing. So far, we have not been able to use Maretron software to change a Data instance. And changing the other instance, the Device instance can also be done straight from the Victron GX device its user interface. To change a Data instance, for example to fix instance conflicts as reported by the Maretron software, we recommend to use Actisense. Not Maretron.

Changing the instances from the GX command line:

Instead of using Actisense or Maretron software, it is also possible to change the VE.Can aka N2K Device instance from the GX Device shell. To get root access, follow these instructions: [Venus OS: Root Access](#).

Once logged into the shell, follow below instructions. More back ground information of the used commands such as dbus and dbus-spy is found by reading about root access document.

! **WARNING:** Better use an Actisense!
The procedure described in the following paragraphs is not normally recommended. Use an Actisense instead, see the Actisense method explained earlier.

New method - changing a Device instance:

All devices available on the canbus are enumerated under the *com.victronenergy.vecan* service. And for all devices that support the necessary can-bus commands, the Device instance can be changed. All Victron products support changing their Device instance; and most or all non-Victron products as well.

```
# dbus -y com.victronenergy.vecan.can0 / GetValue
value = {
  'Devices/00002CC001F4/DeviceInstance': 0,
  'Devices/00002CC001F4/FirmwareVersion': 'v2.73',
  'Devices/00002CC001F4/Manufacturer': 358,
  'Devices/00002CC001F4/ModelName': 'Cerbo GX',
  'Devices/00002CC001F4/N2kUniqueNumber': 500,
  'Devices/00002CC001F4/Nad': 149,
  'Devices/00002CC001F4/Serial': '0000500',
  'Devices/00002CC005EA/CustomName': 'Hub-1',
  'Devices/00002CC005EA/DeviceInstance': 0,
```

```
'Devices/00002CC005EA/FirmwareVersion': 'v2.60-beta-29',
'Devices/00002CC005EA/Manufacturer': 358,
'Devices/00002CC005EA/ModelName': 'Color Control GX',
'Devices/00002CC005EA/N2kUniqueNumber': 1514,
'Devices/00002CC005EA/Nad': 11,
'Devices/00002CC005EA/Serial': '0001514',
'Devices/00002CC005EB/CustomName': 'SmartBMV',
[and so forth]
```

To change them, do a SetValue call to the DeviceInstance path like below. Or, perhaps easier, use the dbus-spy tool.

These lines read it, then changes it to 1, then reads it again:

```
root@ccgx:~# dbus -y com.victronenergy.vecan.can0 /Devices/00002CC005EB/DeviceInstance GetValue
value = 0
root@ccgx:~# dbus -y com.victronenergy.vecan.can0 /Devices/00002CC005EB/DeviceInstance SetValue %1
retval = 0
root@ccgx:~# dbus -y com.victronenergy.vecan.can0 /Devices/00002CC005EB/DeviceInstance GetValue
value = 1
```

[note that numbers, like can0, and 00002CC005EB can ofcourse be different on your system].

New method - changing Data instance:

This applies only to the NMEA2000-out feature.

The Data instances used for the NMEA2000-out feature are stored in local settings. Here is a snippet of the lines, taken by using the dbus-spy tool that also allows changing entries (the Data instances are the "Battery-", "DC Detailed-", and so forth instances):

```
Settings/Vecan/can0/Forward/battery/256/BatteryInstance0      0  <- Data instance for main voltage measurement
Settings/Vecan/can0/Forward/battery/256/BatteryInstance1    1  <- Data instance for starter or mid-voltage
Settings/Vecan/can0/Forward/battery/256/Description2
Settings/Vecan/can0/Forward/battery/256/IdentityNumber      15
Settings/Vecan/can0/Forward/battery/256/Instance            1
Settings/Vecan/can0/Forward/battery/256/Nad                 233 <- Source address - no need, also not good.
Settings/Vecan/can0/Forward/battery/256/SwitchInstance1     0  <- Data instance for switchbank
Settings/Vecan/can0/Forward/battery/256/SystemInstance      0
Settings/Vecan/can0/Forward/solarcharger/0/DcDataInstance0  0
Settings/Vecan/can0/Forward/solarcharger/0/DcDataInstance1  1
Settings/Vecan/can0/Forward/solarcharger/0/Description2
Settings/Vecan/can0/Forward/solarcharger/0/IdentityNumber   25
Settings/Vecan/can0/Forward/solarcharger/0/Instance         0
Settings/Vecan/can0/Forward/solarcharger/0/Nad              36
Settings/Vecan/can0/Forward/solarcharger/0/SystemInsta      0
Settings/Vecan/can0/Forward/solarcharger/1/DcDataInstance0  0  <- Battery voltage & current
Settings/Vecan/can0/Forward/solarcharger/1/DcDataInstance1  1  <- PV voltage & current
Settings/Vecan/can0/Forward/solarcharger/1/Description2
Settings/Vecan/can0/Forward/solarcharger/1/IdentityNumber   24
Settings/Vecan/can0/Forward/solarcharger/1/Instance         0
Settings/Vecan/can0/Forward/solarcharger/1/Nad              36
Settings/Vecan/can0/Forward/solarcharger/1/SystemInstance   0
Settings/Vecan/can0/Forward/solarcharger/258/DcDataInstance0 0
Settings/Vecan/can0/Forward/solarcharger/258/DcDataInstance1 1
Settings/Vecan/can0/Forward/solarcharger/258/Description2
Settings/Vecan/can0/Forward/solarcharger/258/IdentityNumber  23
Settings/Vecan/can0/Forward/solarcharger/258/Instance       0
Settings/Vecan/can0/Forward/solarcharger/258/Nad            36
Settings/Vecan/can0/Forward/solarcharger/258/SystemInstance  0
```

Old method:

1. List the devices:

```
root@ccgx:~# dbus -y
com.victronenergy.bms.socketcan_can0_di0_uc10
com.victronenergy.charger.socketcan_can0_dil_uc12983
```

2. Change it, for example, to 4:

```
root@ccgx:~# dbus -y com.victronenergy.charger.socketcan_can0_di0_uc12983 /DeviceInstance SetValue %4
retval = 0
```

3. Wait a few seconds, and double check:

```
root@ccgx:~# dbus -y
com.victronenergy.bms.socketcan_can0_di0_uc10
com.victronenergy.charger.socketcan_can0_di4_uc12983
```

Device instance changed successful!

15.8.6. PGN 60928 NAME Unique Identity Numbers

The GX device will assign an individual Unique Identity Number to each Virtual-device. The number assigned is a function of the *PGN 60928 NAME Unique Identity Number block* aka *Unique device number for VE.Can* as configured in the settings of the GX device.

This table shows how changing that setting translates into the virtual-devices as made available on the CAN-bus:

Configured Unique Identity block:	1	2	3	4
GX device	500	1000	1500	2000
1st virtual-device (for example a BMV)	501	1001	1501	2001
2nd virtual-device (for example another BMV)	502	1002	1502	2002
3rd virtual-device (for example a third BMV)	503	1003	1503	2003

16. RV-C Support

16.1. RV-C Introduction

As of Venus OS v2.90, Victron supports the RV-C protocol.

What is the RV-C protocol?

RV-C (Recreational Vehicle-CAN) is a CAN-bus-based communication protocol, similar to NMEA 2000 for boats. It is widely used in the US to allow RV components and appliances to communicate with each other.

RV-C has two main functions:

- RV-C out: Enables Victron devices to be monitored and controlled via an RV-C control panel.
- RV-C in: Allows Victron GX devices to receive and display data from compatible third-party RV-C devices.

In summary, when this feature is enabled with the GX device connected to an RV-C network, an RV-C control panel can read Victron data, e.g. from a BMV or an inverter/charger and display it to the user or even control some of them. Compatible RV-C devices are displayed on the GX unit at the same time.

RV-C is built upon [SAE J1939](#).

16.2. Limitations

VE.Can devices

The RV-C and VE.Can protocols are not compatible. A VE.Can port on a GX device can be configured for either the VE.Can profile or the RV-C profile, not both simultaneously.

Some GX devices have only one fully functional VE.Can port. Therefore, when RV-C connectivity is required, this limits which other devices can be used in the system.

Typical RV-related products, which therefore cannot be used in the situation described above:

- The Lynx Smart BMS and Lynx BMS NG cannot be used, as it requires a VE.Can connection. Use a VE.Bus BMS instead (connects via VE.Bus).
- The Lynx Smart Shunt is not compatible; use a SmartShunt instead (connects via VE.Direct).
- High-power MPPT charge controllers must be connected via VE.Direct, not via VE.Can.

GX device compatibility

Depending on the system design, this limitation affects the choice of GX device:

- Color Control GX (CCGX), MultiPlus-II GX, and EasySolar-II GX: Each has only one VE.Can port, which can be configured for either VE.Can or RV-C, not both. For example, you cannot use a Lynx Smart BMS and connect to an RV-C network simultaneously.
- Cerbo GX & Cerbo-S GX: Like above, these models have only one fully functional VE.Can port. Again, it's either VE.Can or RV-C, not both.



Note: The BMS-Can port on the Cerbo GX is limited and cannot be used for RV-C.

- Cerbo GX MK2: Almost identical to the Cerbo GX, but with two VE.Can ports, allowing simultaneous connection to both VE.Can and RV-C networks.
- Venus GX: Equipped with two VE.Can ports, allowing simultaneous connection to both VE.Can and RV-C networks.
- Ekran GX: Also has two VE.Can ports, and can be connected to both VE.Can and RV-C at the same time.

16.3. Supported Devices

As of Venus OS v2.90, RV-C output support has been added for a range of Victron products. The following devices are supported:

Victron product	RV-C In	RV-C Out	Remarks
VE.Bus Inverter/Charger		Yes	Inverter and charger functions can be controlled separately (on/off) via RV-C. Shore input current limit can also be set.
Smart IP43 Charger 120-240V		Yes	Can be switched on/off via RV-C. Shore input current limit is configurable.
Smart IP43 Charger 230V		Yes	Read-only via RV-C. Cannot be controlled.
Skylla-i and Skylla-IP44/IP65		Yes	Requires two fully functional CAN-bus interfaces. Currently only supported by Venus GX, Cerbo GX MK2 and Ekran GX.
VE.Direct Inverter		Yes	
Inverter Smart and Inverter RS		Yes	
Solar chargers incl. MPPT RS		Yes	
Orion XS		Yes	Only when charging from alternator
Batteries: <ul style="list-style-type: none"> • BMV, SmartShunt, Lynx Shunt, Lynx Ion BMS, Lynx Smart BMS, Lynx BMS NG 		Yes	
Tanks: <p>Tank level data is supported from the following input sources:</p> <ul style="list-style-type: none"> • GX device tank level input • GX Tank 140 • VE.Can and/or NMEA 2000 port on the GX device 		Yes	
RV-C tank sensors <ul style="list-style-type: none"> • Note: The Garnet SeeLevel II 709 sensor only reports relative tank level, as it does not provide absolute level or tank capacity. Tanks connected via another GX device may show absolute level and capacity, but cannot be configured through RV-C. <p>For advanced parameters and RV-C programming details, refer to the RV-C [203] section in the appendix.</p>	Yes		
Generator auto start/stop		Yes	Only toggle the auto start option
Third-part batteries <ul style="list-style-type: none"> • Battleborn • Lithionics 	Yes		

16.4. RV-C Configuration

RV-C is configured via the GX device:

1. Open the Remote Console.
2. Navigate to: Settings → Connectivity → VE.Can port [port_number] (if multiple VE.Can ports are present).
3. Select CAN-bus profile, then choose RV-C (250 kbit/s).

Once selected, the RV-C profile becomes active, and the previously selected profile is deactivated (associated equipment like VE.Can devices become unavailable in the GUI).

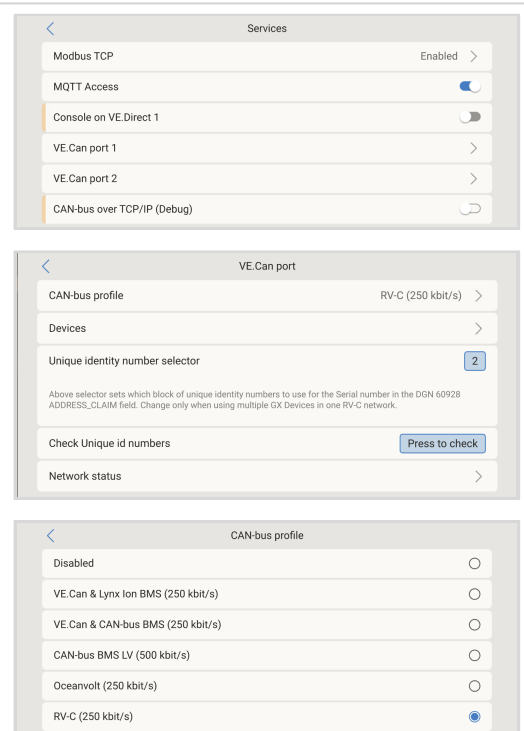

16.4.1. Configuration of RV-C out devices

RV-C out devices can be configured from the Devices submenu in the VE.Can port menu.

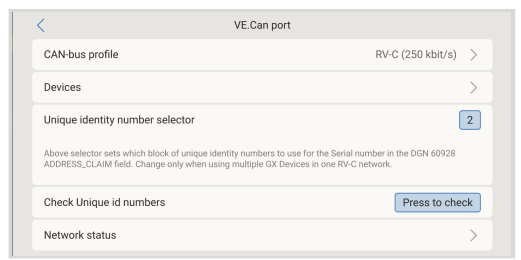

The Devices submenu contains all devices of the RV-C network including RV-C out devices. The latter are identified by their [VRM# instance], which can be used to determine the "real" devices from the root menu of the GX device. The hexadecimal on the right-hand side is the Source Address.

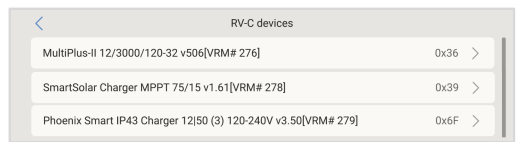

When you enter the submenu of an RV-C device, you will see general RV-C device information and more importantly the configuration menu if you scroll down to the bottom of the page. Viewing the configuration menu requires at least user and installer access level, see chapter [Menu structure and configurable parameters \[87\]](#).

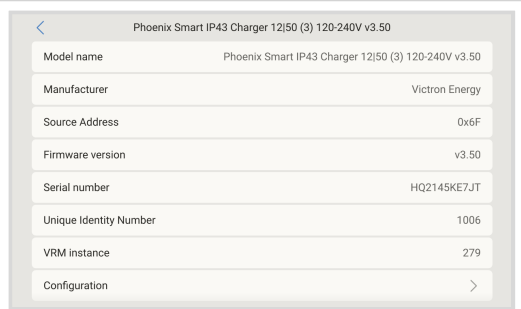

The instance for the corresponding DGNs can be changed in the Configuration submenu.



16.5. Garnet SeeLevel II 709-RVC & Victron GX device support

With RV-C support in Venus OS, the Garnet SeeLevel 709-RVC and SeeLevel Soul can be used to display tank level data on both the GX device and VRM. All 709-RVC models and the SeeLevel Soul are compatible with the GX.

Limitations

- When a CAN-bus port on a GX device is configured for RV-C, it cannot be used simultaneously for VE.Can or NMEA 2000 functions. It's either VE.Can/NMEA 2000 or RV-C, not both on the same port.
- Devices such as the Venus GX, Cerbo GX MK2 and Ekran GX, which have two fully functional VE.Can ports, support running VE.Can and RV-C in parallel.
- If RV-C use blocks essential VE.Can connectivity on your GX device, it is recommended to use the Garnet SeeLevel 709-N2K instead, which communicates via NMEA 2000 and avoids these limitations.
- Tank levels shown on the GX device (and VRM) will appear as percentages only. The system does not display volume in litres, gallons, or other units.

16.5.1. Wiring the Garnet SeeLevel II 709-RVC tank level sensor to a GX device

Before connecting to a GX device, ensure the Garnet SeeLevel 709-RVC is installed and configured according to Garnet's installation instructions.

The GX device requires an RJ45 connector on its VE.Can port, while the Garnet SeeLevel panel typically provides either:

- A multi-pin RV-C connector, or
- A wired connection with one black, one blue, and one white wire.

To connect the two, an adapter cable must be made based on the pin assignments provided below.

A standard CAT5 Ethernet cable is well-suited for this purpose. One end of the cable is cut and connected to the Garnet panel wires, while the RJ45 plug remains on the GX device end.

Garnet panel wire colour code	RV-C connector	Victron VE.Can RJ45	CAT5 Ethernet wire colour code	Signal
Black	4	3	Green/White	Ground
Blue	3	8	Brown	CAN-L
White	2	7	Brown/White	CAN-H

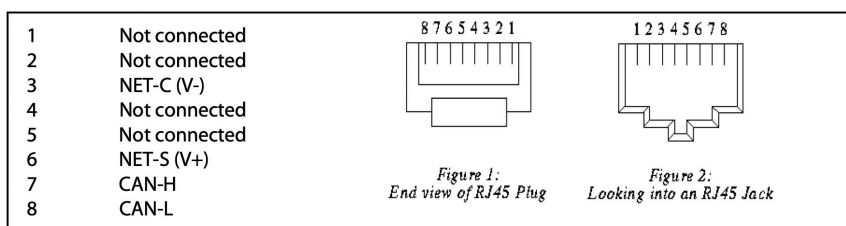

Victron VE.Can pinout

16.5.2. Installation and configuration

1. Route the cable from the Garnet panel to the GX device.
2. Ensure both the Garnet panel and GX device are powered off.
3. Connect the RJ45 plug to the VE.Can port of the GX device and the other end of the adapter cable to the Garnet panel.
4. Check bus termination:
 - For the GX device, use the supplied blue VE.Can RJ45 terminator.
 - Proper termination is mandatory, especially if the Garnet SeeLevel is the only RV-C device on the bus.
5. Once everything is connected, power on both devices.
6. Complete the setup by following the steps in the [RV-C Configuration chapter \[160\]](#) section to configure the VE.Can port for the RV-C profile.

17. Digital Inputs

The Ekrano GX digital inputs are shown in the [Overview of connections](#). [4]

Electrical characteristics

- Inputs are non-isolated
- Operate at 3.3 V logic level
- Each input includes an internal 10 kΩ pull-up resistor to 3.3 V
- Can safely withstand input voltages up to 5 V

For reliable operation, we recommend connecting the inputs to a potential-free switch or relay contact, open-collector, or optocoupler output.

17.1. Configuration

Each digital input can be configured as one of several predefined sensor types, with the option to set them up as alarms.

Pulse Meter is supported in the Ekrano GX.

The possible configurable functions are:

Function	States
Pulse meter	N/A
Door alarm	Open/Closed
Bilge pump	On/Off
Bilge alarm	Ok/Alarm
Burglar alarm	Ok/Alarm
Smoke alarm	Ok/Alarm
Fire alarm	Ok/Alarm
CO2 alarm	Ok/Alarm
Generator	Running/Stopped

The function of each input can be configured in the Remote Console under Settings → Integrations → Digital I/O.

Once the input is configured for its intended purpose, it will show up in the Device list.

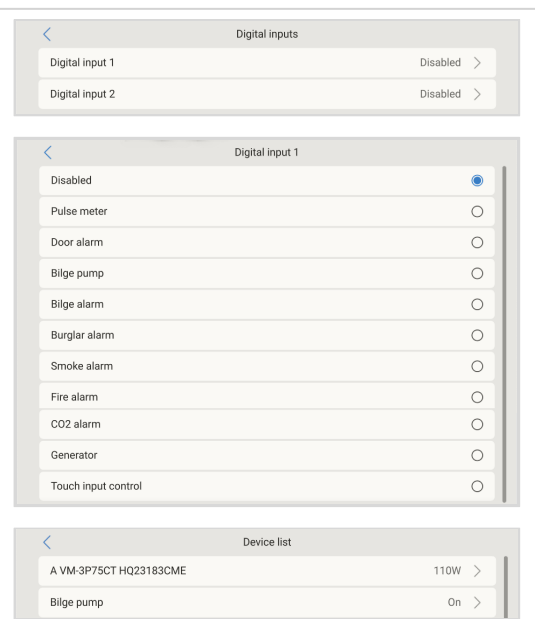

Other parameters related to that function can be configured by entering the device menu from the Device list and selecting Setup.

For sensors and alarms, you can decide whether the input should be treated as an alarm condition, whether the labels should be inverted, and whether the logical levels should be inverted.

- To swap the labels attached to the alarm, set Inverted to on.
- If a logical low input (0V) should be considered a positive condition, set Inverted alarm logic to on.

For GX devices whose digital inputs can be used as pulse meters (Cerbo GX MKII, Ekrano GX and Venus GX), you can configure the unit and multiplier (representing the volume per pulse) and reset the counter as needed.

The screenshot shows the configuration interface for a 'Bilge pump'. It is organized into three distinct menu sections:

- Bilge pump:** Contains 'State' (set to 'On'), 'Setup', and 'Device' options.
- Setup:** Contains 'Enable alarm' and 'Inverted' options, both with toggle switches.
- Setup:** Contains 'Volume unit' (set to 'Liters'), 'Inverted' (with a toggle switch), 'Multiplier' (set to '0'), and 'Reset counter' (with a '0' button).

17.2. Read-out of digital inputs via Modbus TCP

The values/states of the digital inputs can be read via Modbus TCP.

For full details, refer to the following resources available on our website:

- [Modbus-TCP Register List](#) (downloadable document)
- [Modbus-TCP FAQ](#) in the [GX Modbus-TCP Manual](#)

18. GX - Generator auto start/stop

18.1. Introduction

By integrating an AC or DC generator with a GX device, the following features become available:

General features:

1. **Automatic generator control:** Start and stop the generator automatically using the “Generator auto start/stop” functionality based on various system conditions.
2. **Manual control and scheduling:** Start and stop the generator manually, with the option to schedule a timed run.
3. **Service tracking:** Monitor operating hours and service intervals.
4. **Extended genset lifespan:** Integrated warm-up and cool-down features ensure proper lubrication before load application and prevent sudden shutdowns.

For connected gensets:

1. **Performance monitoring:** View AC or DC production data.
2. **Engine parameter tracking:** Monitor pressure, temperature, RPM, starter battery voltage, and fuel tank levels.
3. **Error alerts:** Receive notifications on system errors.
4. **DVCC support:** Selected DC generators support Distributed Voltage and Current Control (see the [DVCC - Distributed Voltage and Current Control \[111\]](#) chapter).

Monitoring and control are available not only on the GX device itself, but also through the VRM portal and the Marine MFD HTML5 app. For more details, refer to the [VRM Portal \[120\]](#) and [Marine MFD integration by App \[127\]](#) chapters.

More general information about planning a Victron system with a generator is also available in the [MultiPlus Generator FAQ](#).

18.2. How to integrate

There are two integration options:

1. **Relay-Controlled Integration:** A wired potential-free start/stop signal is supported via Relay 1 of the GX device (see section 17.2.7 for Relay-Controlled Start/Stop Signal).
2. **Connected genset integration:** If the generator or its controller is listed in the table below, digital communication is supported for readout and control via VE.Can, Ethernet, or RS485 (using an RS485-to-USB converter such as the [Victron RS485 to USB interface](#)).

Supported AC generator controllers for connected genset integration

Manufacturer	Model	Connection type	Remarks
ComAp	InteliLite 4 AMF 25 InteliLite 4 AMF 20 InteliLite 4 AMF 9 InteliLite 4 AMF 8 InteliLite 4 MRS 16	Ethernet	
CRE Technology	Compact AMF Gensys Compact Prime Gensys Compact Mains	Ethernet	
Deep Sea Electronics	DSE4620 DSE6120 DSE4510 MKII DSE4520 MKII DSE6110 MKII DSE6120 MKII	Ethernet or RS485	For Ethernet: See ¹⁾ For RS485: See ²⁾ and ³⁾

Manufacturer	Model	Connection type	Remarks
	DSE7310 MKII		For Ethernet: See ¹⁾ For RS485: See ³⁾
	DSE 7410 MKII		For RS485: See ⁴⁾
	DSE 7420 MKII		
	DSE8610 MKII		
	DSE8620 MKII		
	DSE8660 MKII		
DEIF	AGC 150 Generator	Ethernet or RS485	For RS485: See ⁴⁾
	AGC 150 Hybrid		
	AGC 150 PMS Lite		
Fischer Panda	xControl	VE.Can	
	iGenerator		
	fpControl		

¹⁾ This model does not include Ethernet connectivity. Therefore, the Deep Sea Electronics DSE855 USB-to-Ethernet communication device, or another Ethernet-enabled DSE gateway, is required.

²⁾ This model does not include RS485 connectivity. Therefore, the Deep Sea Electronics DSE857 USB-to-RS485 communication device, or another RS485-enabled DSE gateway, is required.

³⁾ The Hjelmstedt Electronics USB485-STIXL Isolated USB to RS485 converter is required (<https://hjelmstedt.eu/>)

⁴⁾ This model includes a built-in isolated RS485 port; however, the [Victron RS485 to USB interface](#) is required.

Supported DC generator controllers for connected genset integration

Manufacturer	Model	Connection type	Notes
Fischer Panda	fpControl	VE.Can	
Hatz	fiPMG	VE.Can	Supports DVCC voltage control

 **The GX device supports only one connected genset controller. When integrating via Ethernet, ensure that only one genset controller is accessible to the GX device.**

18.2.1. Relay-controlled start/stop signal

Most generators support an external start/stop signal, typically via a potential-free contact. Closing the contact starts the generator, while opening it stops it.

Some generators require pulsed signals instead of a continuous connection. In such cases, additional timing relays may be needed (see below). Always refer to the generator manual or consult the supplier for details on the remote start signal wire configuration.

On the GX device, Relay 1 must be used to control the generator. After wiring the generator input to Relay 1, go to Settings → Integrations → Relay → Function (Relay #) → Genset start/stop.

Once Relay 1 is configured to “Genset start/stop”, the related settings can be accessed via Settings → Devices → Genset.



18.3. Generator start/stop menu

The general overview page of the generator start/stop function can be accessed from Settings → Devices → Genset. This page can be used to monitor the generator's status, view the error status, access Run time and service and make necessary settings.

The individual menu items have the following functions:

- **Auto start functionality:** Enables the generator auto start/stop function based on defined conditions set in the Conditions menu.
- **Manual control:** See the Manual Start Feature section for details.
- **Current run time:** Generator run time since last start.
- **Control status / State:** Displays the current status of the generator. Possible state messages:
 - Stopped, Warm-up, Manually started, Running by condition, Cool-down, Stopping
- **Control error code / Error:** Error description.
- **Genset status:** Status reported by the genset controller (*)
- **Genset error code:** Error code reported by the genset controller (*)
- **AC phases:** Voltage, Current and Power readings (*)
- **Remote start mode:** If enabled, the connected genset controller is set to the correct mode to be remotely started by the GX device (*)
- **Engine:** Displays various controller readings (if supported by the controller): (*)
 - Speed
 - Load
 - Oil pressure
 - Oil temperature
 - Coolant temperature
 - Exhaust temperature
 - Winding temperature
 - Starter battery voltage
 - Number of starts
- **Run time and service:** Display various time-related values: (*)
 - Total run time
 - Daily run time (last 30 days)
 - Time to service
 - Generator service interval
- **DC genset settings:** Contains settings for charge voltage and current and BMS control (*2)
- **Settings:** This is the gateway to all other features.

(*) Only applicable to connected gensets.

(*2) Only applicable to connected DC gensets.

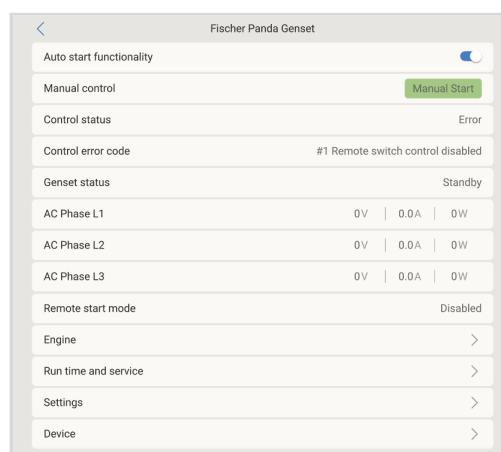
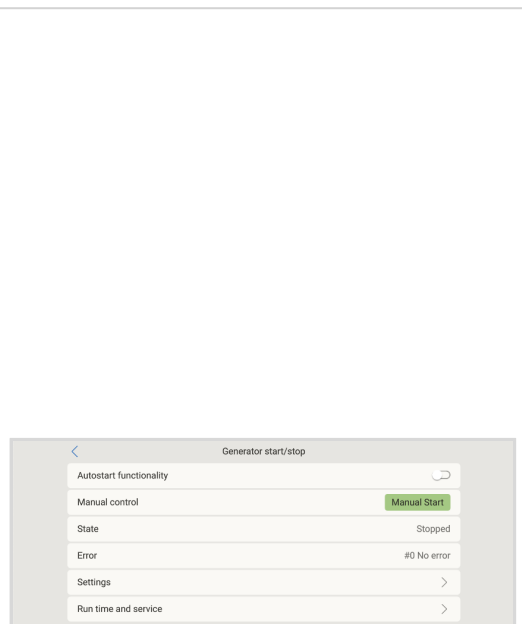

18.4. Settings menu

In the Generator start/stop menu, scroll down and tap on Settings to bring up the Settings menu.

- **Conditions:** The Conditions menu defines when the generator should start and stop automatically. See the [Auto start/stop conditions \[170\]](#) chapter for details.
- **Minimum run time:** The minimum running time of the generator can be set here. It's good practice for a generator, once started, to be allowed to reach its operating temperature. When started manually, this setting is ignored.
- **Warm-up & cool-down:** Allows a configurable time to be set for the generator to warm up or cool down via relay control while the AC input relay is open and the inverter/charger is not connected to it. See the [Warm-up & cool-down menu \[169\]](#) section for details. Note that this feature requires an update of the VE.Bus inverter/charger to firmware 502 or later.
- **Detect generator at AC input:** Enabling this feature will raise an alarm on the GX device, as well as trigger an alarm email from the VRM portal:
 - whenever power is not detected at the AC input terminal of the Inverter/Charger. This function will bring attention to a wide variety of problems; such as lack of fuel, or a mechanical or electrical fault at the generator. This functionality is not available for VE.Can connected Multi/Quattros.
 - It requires automatic alarm monitoring on VRM to be enabled, which it is by default.
- **Alarm when generator is not in auto start mode:** See the [Alarm when generator is not in autostart mode section \[168\]](#) for details.
- **Quiet hours:** See the [Quiet hours section \[175\]](#) in the [Conditions chapter \[170\]](#).

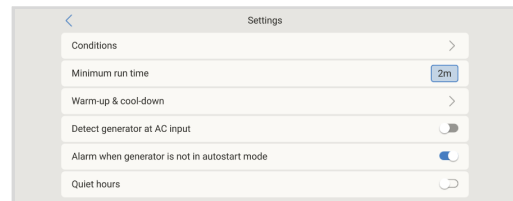

18.4.1. Alarm when autostart function is disabled

If this option is enabled, an alarm will trigger if the autostart function remains disabled for more than 10 minutes. This is particularly useful after generator servicing, in case the technician forgets to re-enable autostart mode.

This feature ensures that the autostart function is not unintentionally left disabled. For digitally connected gensets, such as DSE, ComAp, and Fischer Panda, it also checks whether remote starts are enabled on the genset panel. Two alarms can be triggered:

1. "GX Auto start/stop is disabled" – Raised when autostart is manually disabled on the GX device.
2. "Remote start is disabled on the genset" – Raised when the genset panel does not allow remote starts, such as inside DSE, ComAp, or Fischer Panda systems. This is usually done during genset servicing.

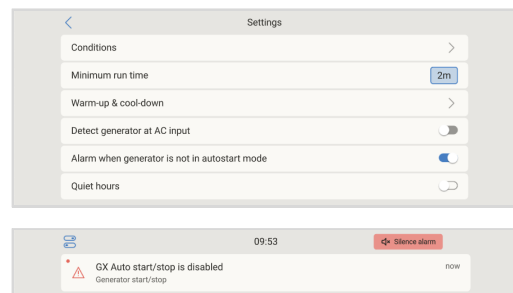

18.4.2. Run time and service interval menu

Every generator requires servicing after a certain period. The recommended maintenance interval depends primarily on usage and run time. This menu allows you to set a service interval, starting a counter that triggers a warning when maintenance is due.

The menu items in detail:

- **Reset daily run time counters:** Resets the 7-day run-time history.
- **Generator total run time (hours):** Reset or adjust the total run time to match the generator's actual run hours. This also updates the 'Total run time' display in the generator start/stop overview.
- **Generator service interval (hours):** Set the generator's service interval in hours. Refer to the generator manual for specific guidelines.
- **Reset service timer:** Resets the service timer. Use this after servicing the generator to restart the 'Time to service' counter.

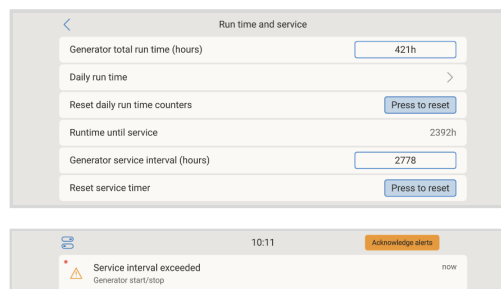

18.4.3. Warm-up & cool-down menu

The warm-up and cool-down menu allows you to configure the time the generator needs to warm up or cool down before or after operation. This is controlled via relay while the AC input relay is open and the inverter/charger is not connected.

This menu also applies to digitally connected gensets (e.g., over Modbus), where the GX relay is not used.

Note: This feature requires VE.Bus inverter/charger firmware 502 or later. It is also supported on Multi RS inverter/chargers running firmware v1.17 or later.

Warm-up time:

- The time required for the generator to warm up before the Multi/Quattro accepts the AC input. The GX device signals the generator to start, but the Multi/Quattro will only close the transfer switch after this period has elapsed.

Cool-down time:

- The time required for the generator to cool down before shutting off. During this period, the Multi/Quattro disconnects the AC input and runs the load from the batteries. Once the time has elapsed, the GX signals the generator to stop.

Some generators do not stop immediately when given a signal; see the next setting for adjustments.

Generator stop time:

- After the cool-down period, the GX signals the generator to stop, but the Multi/Quattro waits for this time to elapse before accepting AC input again.

This setting is only needed if the generator takes time to shut down without automatically disconnecting AC. In such cases, set a slightly longer delay to prevent the Multi/Quattro from reconnecting before the generator is fully off. If set to zero, the Multi/Quattro will accept AC input immediately after the cool-down phase.

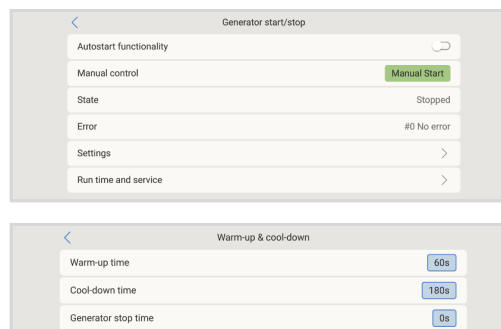

18.5. Auto start/stop conditions

On loss of communication: If communication between the EGX and the VE.Bus inverter/charger is lost, and generator start/stop parameters depend on this data, choose one of the following actions:

- **Stop the generator (default):** Stops the generator if it is running.
- **Start the generator:** Starts the generator if it is not running.
- **Keep running:** Keeps the generator running if it was active when communication was lost.

Stop generator when AC-input is available: Useful for backup systems where a Quattro is connected to mains/grid on AC-in 1 or AC-in 2, with a genset on the other AC input. When enabled, the genset will only stop once mains power is restored after a failure.

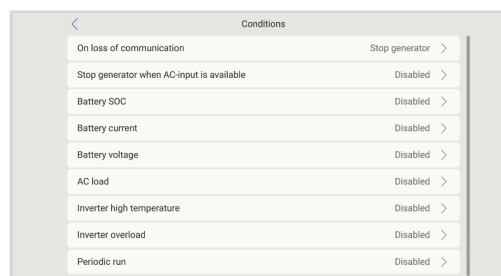

The following parameters may be user-defined to trigger an automatic generator start/stop:

- [Manual \[174\]](#)
- [Stop generator when AC-input is available \[170\]](#)
- [Battery SoC \[171\]](#)
- [Battery current](#)
- [Battery voltage \[172\]](#)
- [AC load* \[172\]](#)
- [Inverter high temperature \[172\]](#)
- [Inverter overload \[173\]](#)
- [Periodic run \[173\]](#)

(* The value measured here will be the total AC consumption of the system.)

Condition parameters are prioritised in the order listed above. If multiple conditions are met simultaneously, only the highest-priority condition will be displayed as active. All enabled conditions are evaluated, even if the generator is already running. Once the active condition is satisfied, an unmet parameter in a lower-priority condition can keep the generator running.

18.5.1. Stop generator when AC-input is available

This option is ideal for backup systems where a Quattro has one AC input connected to mains power and the other to a generator.

When enabled, and the AC input connected to the grid is defined, the generator will automatically stop once mains power is restored after a grid failure. The process follows these steps:

1. The generator is disconnected first.
2. A cool-down period is applied, based on the configured setting.
3. An additional 15 seconds is allowed for the generator to complete shutdown.

- **Disabled:** Stop generator when AC-input is available is currently disabled
- **AC input 1:** Mains power is connected to AC input 1
- **AC input 2:** Mains power is connected to AC input 2

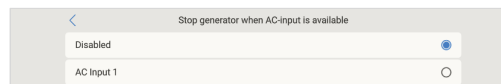

18.5.2. Start/Stop based on Battery SoC

This feature allows generator control based on Battery state of charge (SoC) levels.

- **Use Battery SoC value to start/stop:** Toggle this feature on or off.
- **Start when Battery SoC is lower than:** Sets the SoC threshold for autostart when battery depletion occurs.
- **Start value during quiet hours:** If Quiet hours is enabled, you can delay autostart until absolutely necessary by setting a lower, more critical threshold.
- **Start after the condition is reached for:** Sets a delay before activation, ensuring the condition is sustained before triggering the generator.
- **Stop when Battery SoC is higher than:** Defines the SoC level at which the generator will stop.
- **Stop value during quiet hours:** If Quiet hours is enabled, set a lower stop threshold to minimise generator runtime.
- **Stop after the condition is reached for:** Sets a delay before deactivation, ensuring the condition is sustained before triggering the generator.

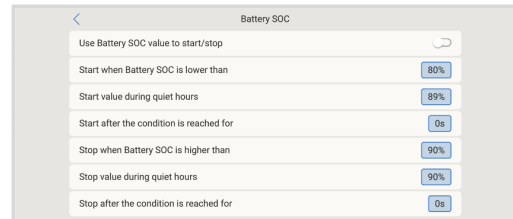

18.5.3. Start/Stop based on Battery Voltage

This feature allows generator control based on battery voltage levels.

- **Use battery voltage value to start/stop:** Toggle the feature on or off.
- **Start when battery voltage is lower than:** The generator will autostart when the battery voltage drops below the specified value.
- **Start value during quiet hours:** If Quiet hours is enabled, set a lower (more critical) threshold to ensure the generator starts only when absolutely necessary.
- **Start after the condition is reached for:** Adds a delay before starting the generator once the voltage reaches the start threshold.
- **Stop when Battery voltage is higher than:** Defines the voltage threshold for autostop.
- **Stop value during quiet hours:** If Quiet hours is enabled, set a lower voltage level to achieve shorter generator run-times.
- **Stop after the condition is reached for:** Adds a delay to ensure voltage level is stable before stopping the generator.

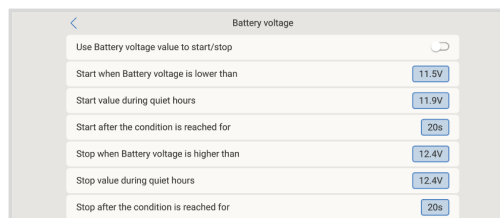

18.5.4. Start/Stop based on AC load

AC load triggers work similarly to other triggers but the feature is refined by a Measurement setting. The Measurement setting is available on firmware v2.0 and later and has three possible values:

1. **Total consumption (Default option)**
2. **Inverter total AC out**
3. **Inverter AC out highest phase**

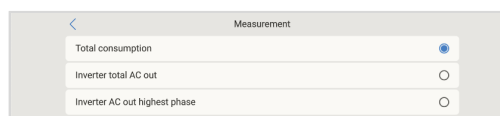
18.5.5. Start/Stop based on Inverter High temperature

This feature allows generator activation based on inverter temperature warnings.

- **Start on high temperature warning:** Toggle this feature on or off.
- **Start when warning is active for:** Sets a delay before starting the generator to prevent activation due to brief temperature spikes caused by short-term high AC demand.
- **When warning is cleared stop after:** Adds a delay before stopping the generator to ensure the inverter temperature reduction, typically due to lower power demand, is stable.

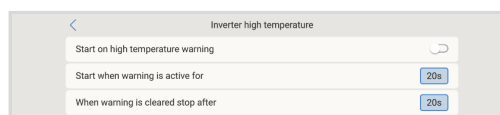

18.5.6. Start/Stop based on Inverter overload

This feature enables generator activation in response to an inverter overload warning.

- **Start on overload warning:** Toggle this feature on or off.
- **Start when warning is active for:** Sets a delay before starting the generator to prevent activation due to brief high AC power demand.
- **When warning is cleared stop after:** Adds a delay before stopping the generator to ensure the reduction in AC power demand is stable.



18.5.7. Start/stop based on tank level

This feature allows generator deactivation based on tank level, preventing airlocks when the tank runs empty.

- **Stop on tank level:** toggle this function on or off.
- **Tank service:** select the tank sensor that provides the tank level data for the generator.
- **Stop when Tank level is lower than:** stop the generator when the tank level falls below the defined threshold.
- **Prevent start until Tank level is higher than:** block generator start until the tank level rises above the defined threshold.
- **Trigger warning when the generator is stopped:** raises a warning when the generator is stopped due to low tank level.

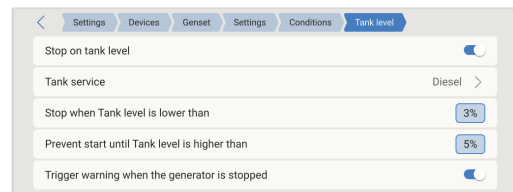

18.5.8. Periodic run

This feature enables automatic periodic generator starts.

- **Run interval:** Set the interval between runs.
- **Skip run if has been running for:** Skips the run if the generator has already run for at least the test duration within the interval.
- **Run interval start date:** Defines when the interval counter starts. No runs will occur before this date.
- **Start time:** Specifies the time of day the run begins.
- **Run duration:** Duration of the run.
- **Run until battery is fully charged:** If enabled, the generator runs until the battery is fully charged instead of for a fixed duration.

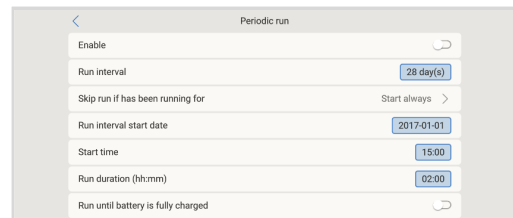

18.5.9. Manual Start Feature

The Manual Start feature allows you to remotely start the generator. If the generator is already running, pressing Start prevents it from stopping automatically when the condition that triggered it is met. In other words, Manual Start overrides autostop parameters.

Ways to start the generator manually:

1. **Using the Manual start menu:** Go to Settings → Devices → Genset → Manual start; and then toggle the graphic to start the generator.
2. **Using the top-left button from the Remote Console:** Press the top-left button  on the EGX, or Ekran GX Remote Console and engage the Generator page. Then press the Start button.
3. **Using the Controls option from the VRM Portal:** See the [VRM Portal manual](#).



If started manually (remotely) without a stop timer (Timed run feature), the generator will run indefinitely until manually turned off.

- The stop timer is available for both manual start methods and prevents the generator from being left running unintentionally.
- The generator can only be stopped manually if no active run condition is unmet.
- To force a stop, first disable the function keeping it running or turn off the Generator start/stop function.

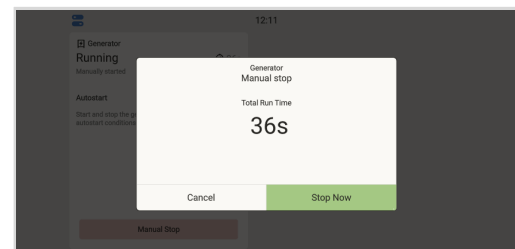
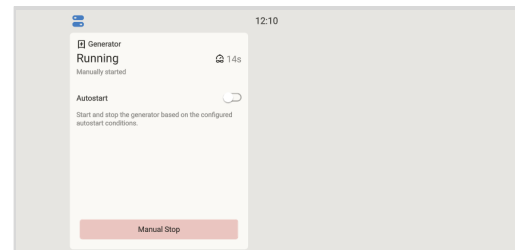
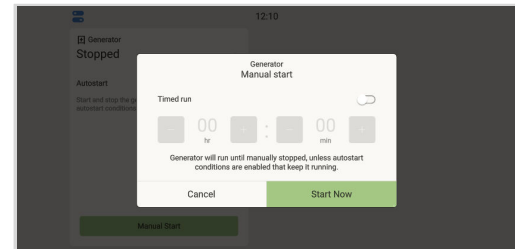

18.5.10. Quiet hours

The Quiet hours feature allows you to set a time period when generator noise would be a nuisance. During this period, the generator will only start if absolutely necessary, using adjusted autostart conditions.

How to Enable Quiet Hours

1. Navigate to Settings → Devices → Genset → Settings.
2. Toggle Quiet Hours ON.
3. Set the start and end times in the fields that appear.

Note that if the start and stop times are set to the same value, Quiet Hours will remain active indefinitely when enabled.

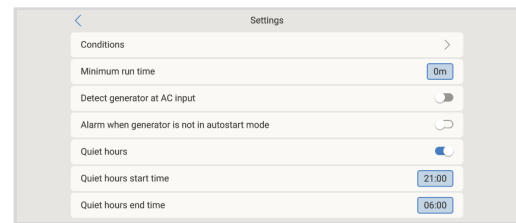

Using Quiet hours as a tool to define two sets of user-preferences

The Quiet hours feature can also be used to customise how your system responds to different conditions. For example:

- **Early morning/low SoC:** Battery SoC is often lowest in the morning. If combined with cloudy weather or solar panels with a westerly bias (performing better in the afternoon), the generator may autostart in the morning due to low SoC. However, later in the day, as solar production increases, the generator's work may become unnecessary. By setting Quiet hours during this period with lower autostart thresholds, you can prevent premature generator starts and make better use of available solar energy.
- **Holiday home:** In a holiday home, power demand is significantly higher when occupied than when empty. The Quiet hours feature can help by applying lower autostart thresholds when the house is in use and higher ones when vacant.

To implement this:

- Set Quiet hours as a permanent condition (see above) while the home is occupied.
- Toggle Quiet hours OFF when the house is empty to allow for standard generator behaviour.

18.6. ComAp controller

18.6.1. Introduction

How does it work?

The GX device communicates (read/send) with the IntelliLite 4 panel via Modbus TCP over Ethernet, using the ComAp CM3-Ethernet module (required) as the communication interface. Re-mapping Modbus registers with the IntelliConfig software is necessary.

An overview of all Modbus registers used and their required mappings can be found in the appendix: [Modbus holding registers for the ComAp IntelliLite 4 controller \[216\]](#)

After applying the mapping, the GX device automatically detects the presence of a ComAp IntelliLite 4 controller by using the identification string located in Modbus register 1307. It will recognise all modules with names starting with "IntelliLite4-." This identification string also appears in the title bar of the IntelliConfig window.



18.6.2. Requirements

- GX device with VenusOS v3.42 or later
- Supported ComAp controller
- CM3-Ethernet module (ComAp order code: CM3ETHERXBX)
It may also work with the standard CM-Ethernet module (ComAp order code: CM2ETHERXBX), but has not been tested.
- Ethernet network equipment

18.6.3. Installation & Configuration

Installation and configuration takes place in just a few steps. You only need to enable the Modbus Server in your CM3-Ethernet module. This can be done from the control panel or using the software for the controller, IntelliConfig, which can be downloaded from the [ComAp website](#).

No further configuration of the ComAp CM3-Ethernet module is required.

The Modbus registers must be adjusted using the IntelliConfig software according to the register list as described in [Modbus holding registers for the ComAp IntelliLite 4 controller \[216\]](#).

ComAp controller configuration

The following procedure outlines the steps for using the IntelliConfig configuration software. Ensure you have the latest version and are connected to the controller:

1. Ensure Correct Units/Power Format:
 - Select the Controller Configuration tab
 - Choose Others
 - Select Units/Power Format
 - Ensure that Units is set to "Metric - 20°C, 10.0 Bar, 11.4 l/h" and Power Format is set to "Standard 1 kW/kVA/kVAR 1 V"

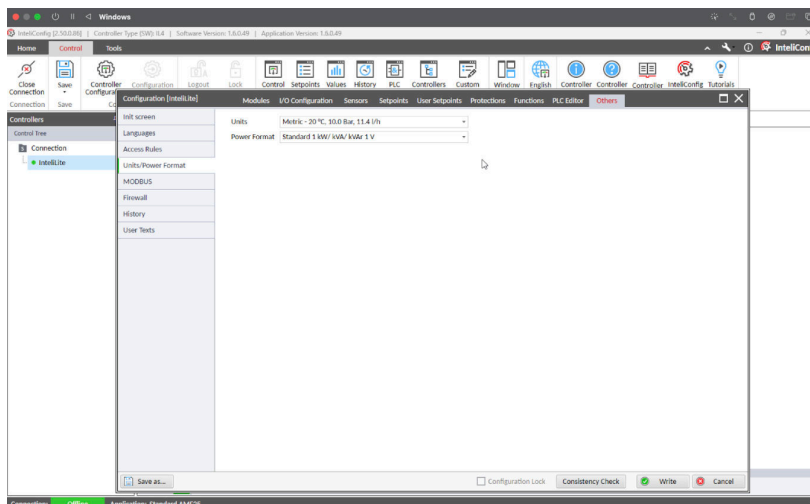

- Choose Sensors
- Select "VDO 10 Bar" and ensure that the Resolution is set to "0,1" and Dim is set to "Bar"

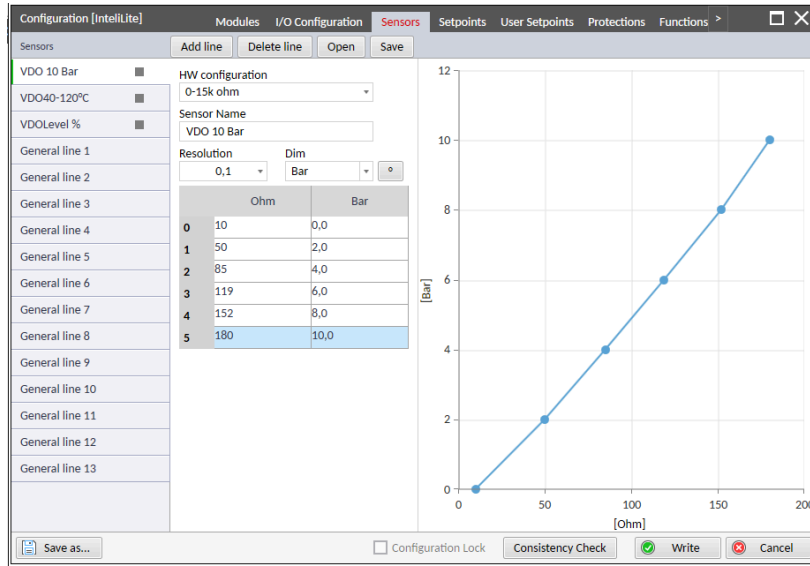

- Now select "VDOLevel %" and ensure that the Resolution is set to "1" and Dim is set to "%"

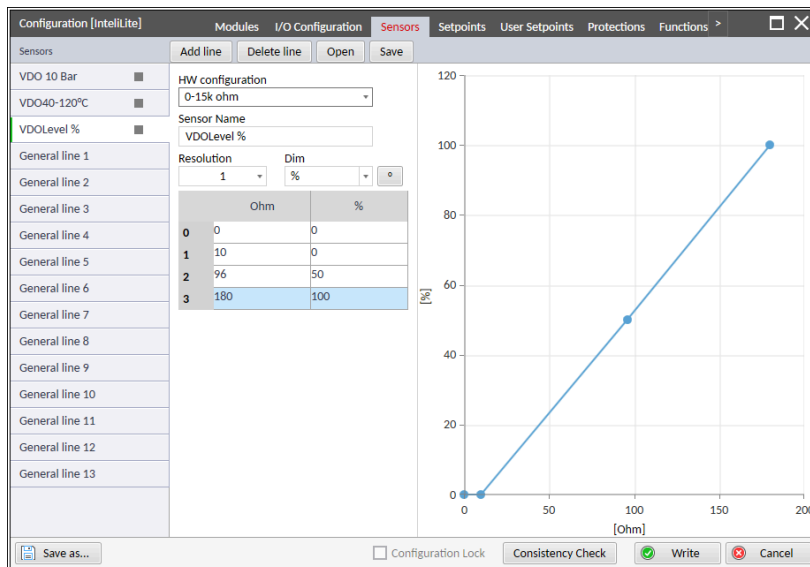

2. Re-mapping Modbus Registers:

- In the same window, select MODBUS
- Download the Modbus mapping file for Victron Energy: [ComAp IntelliLite GX mapping](#)
- At the bottom, under Import/Export, click the Import icon on the right
- Select the downloaded mapping file and click OK
- In the bottom right corner, click the Write button to save the configuration to the controller

The ComAp Modbus mapping UMOD file contains the necessary Modbus register mappings as required by the GX device. A human-readable format of the mapping can also be found in the appendix: [Modbus holding registers for the ComAp IntelliLite 4 controller \[216\]](#).

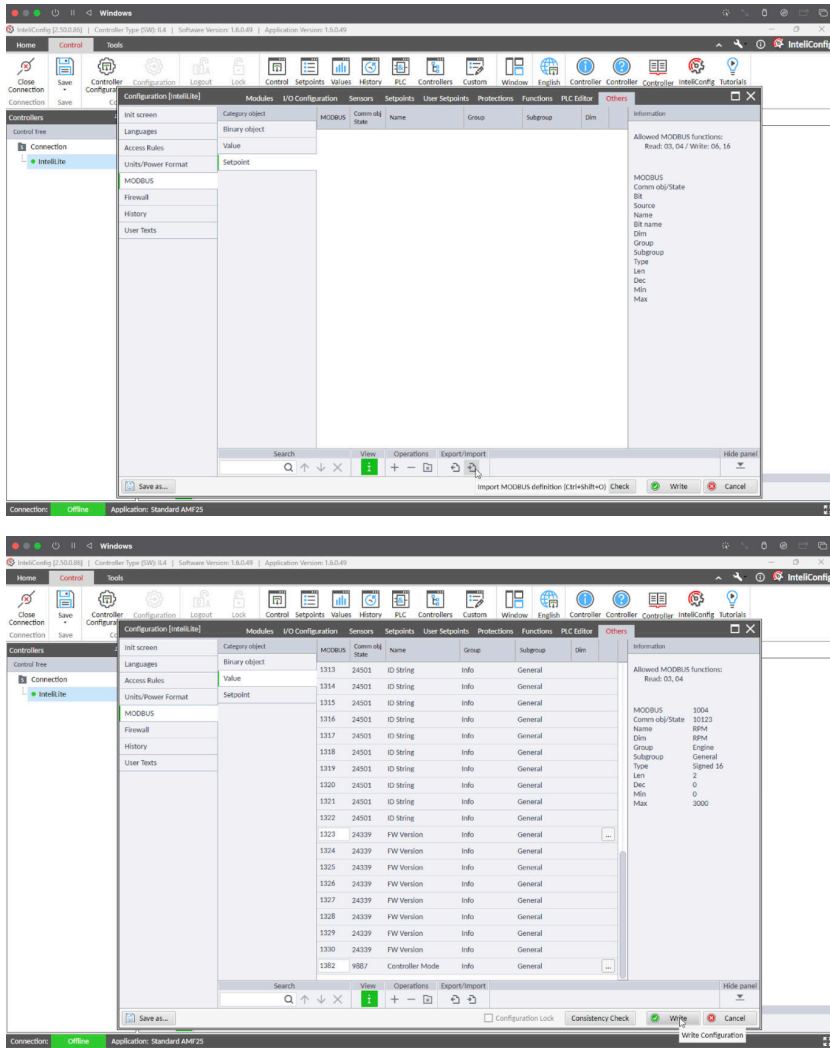

3. Enabling the controller's Modbus server
 - Select the Setpoint tab
 - In the subsequent menu, select the CM-Ethernet module
 - Enable the Modbus Server

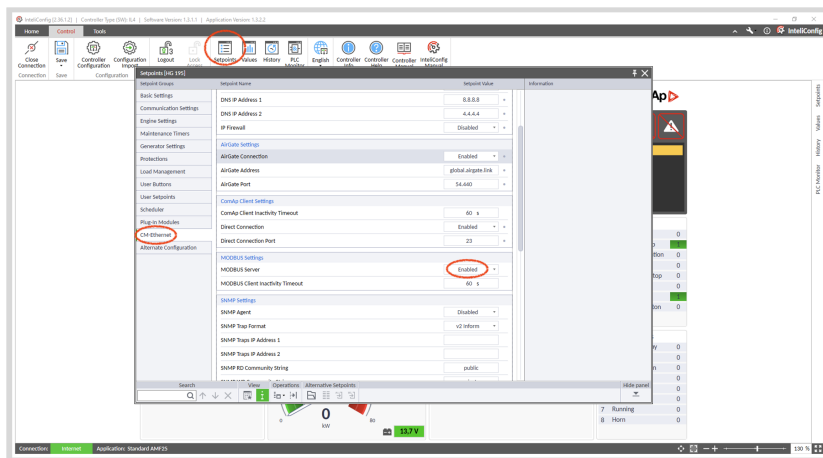

GX device configuration

Once the GX device and the genset controller are connected to the same network, the controller will automatically appear in the Device list. The image shows an example of a DSE generator controller.

If it does not appear, check the Modbus settings on the GX device by navigating to Settings → Integrations → Modbus Devices. Ensure that Automatic Scanning is enabled (this is the default setting) or manually scan for the device; it should be detected and listed under the Discovered Devices sub-menu. For reliable operation, keep automatic scanning enabled, as the network is scanned every ten minutes. If the IP address changes, the device will be rediscovered. However, it is advisable to assign a static IP address to the controller to avoid unexpected communication loss.

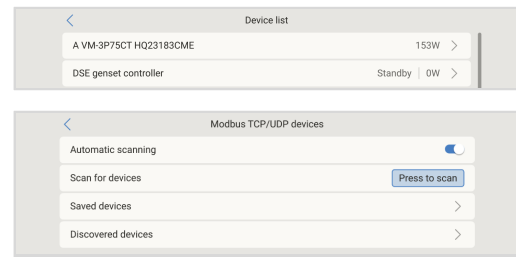

18.7. CRE Technology controller

18.7.1. Introduction

How does it work?

The GX device communicates with the CRE controller by reading and sending data according to the controller's Modbus TCP specification, using the Ethernet connectivity of the CRE controller.

By utilising the identification values retrieved via Modbus, the GX device automatically detects the presence of the controller.

18.7.2. Requirements

- GX device with VenusOS v3.50 or later
- Supported CRE controller with firmware version v2.0 or later
- Ethernet network equipment

18.7.3. Installation & Configuration

Prerequisites

The CRE controller allows you to change the units for pressures and temperatures; however, the GX device expects oil pressure to be configured in bar and temperatures in °C. Please ensure that the units are set correctly.

GX device configuration

Once the GX device and the genset controller are connected to the same network, the controller will automatically appear in the Device list. The image shows an example of a DSE generator controller.

If it does not appear, check the Modbus settings on the GX device by navigating to Settings → Integrations → Modbus Devices. Ensure that Automatic Scanning is enabled (this is the default setting) or manually scan for the device; it should be detected and listed under the Discovered Devices sub-menu. For reliable operation, keep automatic scanning enabled, as the network is scanned every ten minutes. If the IP address changes, the device will be rediscovered. However, it is advisable to assign a static IP address to the controller to avoid unexpected communication loss.

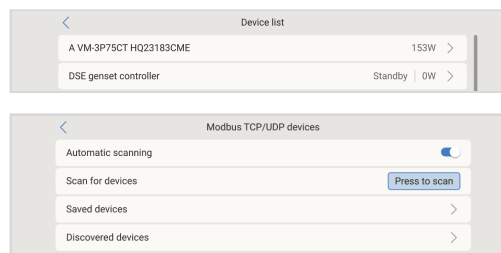

18.8. DSE- Deep Sea generator controller support

18.8.1. Introduction

By integrating a Deep Sea Electronics (DSE) genset controller with a GX device, it is possible to read out AC data, oil pressure, coolant temperature, tank level, number of engine starts and further status readings. In addition, it supports digital start/stop signalling from the GX device.

How does it work?

The GX device communicates with the Deep Sea Electronics (DSE) controller by reading and sending data via the DSE "GenComm" Modbus specification. This communication occurs either through the Ethernet connection of the DSE controller itself or, for controllers without an Ethernet interface, via the Deep Sea Electronics DSE855 USB-to-Ethernet communications device or another compatible Ethernet-enabled DSE gateway that supports Modbus TCP.

Using the identification values obtained via Modbus, the GX device automatically detects the presence of the controller.

18.8.2. Requirements

- GX device with VenusOS v3.12 or later
- Supported DSE controller
- For models that only offer USB connectivity (see the table in [How to integrate \[165\]](#)), a Deep Sea Electronics DSE855 (or a similar device) is required.
- Ethernet network equipment

Special Case: DSE 4520 MKII (Venus OS v3.50 or later)

Unlike all other supported DSE controllers, the DSE 4520 MKII does not accept control commands via digital communication. Therefore, a wired control signal must be used through the "Connected genset helper relay" function. Further information can be found in the next section.

18.8.3. Installation & Configuration

GX device configuration

Once the GX device and the genset controller are connected to the same network, the controller will automatically appear in the device list.

If it does not appear, check the Modbus settings on the GX device by navigating to Settings → Integrations → Modbus Devices. Ensure that Automatic Scanning is enabled (this is the default setting), or manually scan for the device; it should then be detected and listed under the Discovered Devices sub-menu. For reliable operation, keep automatic scanning enabled, as the network is scanned every ten minutes. If the IP address changes, the device will be rediscovered. However, it is advisable to assign a static IP address to the controller to prevent unexpected communication loss.

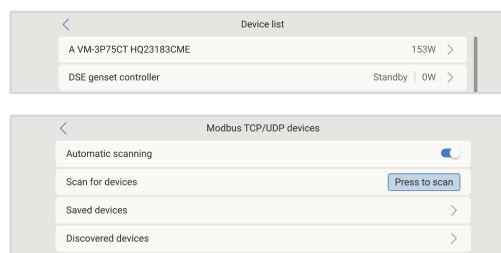

Connected genset helper relay

Relay 1 on the GX device can be configured as a *Connected genset helper relay*.

This setting allows Relay 1 to operate in parallel with the digital control commands of a connected DSE 4520 MKII. Relay 1 remains open while the genset is stopped and closes as soon as the start command is given.

This feature is useful for:

- Providing a wired fallback in case of data communication failure.
- Custom applications, such as controlling an external fuel pump or triggering another control signal.

For wiring instructions, refer to [Relay-controlled start/stop signal \[166\]](#)

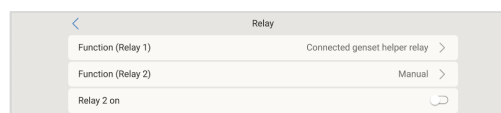

18.9. DEIF controller

18.9.1. Introduction

How does it work?

The GX device reads from and sends data to the DEIF controller via the controller's Modbus specification, using either the Ethernet connection or the RS485 Port 1 of the DEIF controller. By utilizing the identification values found via Modbus, the GX device automatically detects the presence of the controller.

18.9.2. Requirements

- GX device with Venus OS v3.50 or later
- Supported DEIF AGC 150 controller with firmware version 1.19.0 (from May 2024) or later
- For integrating via Ethernet: Ethernet network equipment
- For integrating via RS485: [Victron Energy RS485 to USB interface](#) (part number ASS030572050 or ASS030572018)

18.9.3. Installation & Configuration

Setting the correct scaling parameter

Currently, only the default value for the controller's "Scaling" parameter (Channel 9030, value 100 to 25000 V) is supported. Before connecting, make sure that this setting is correct. The setting is available via the controller's display at Parameter → Basic settings → Measurement setup → Scaling → Scaling. To make changes, enter the master password (default: 2002) and set it to the default range of 100 to 25000 V.

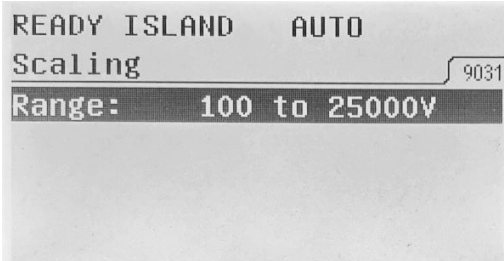

For Ethernet connection

Use the Ethernet port of the DEIF controller to connect it to the same Ethernet network as the GX device.

For RS485 connection

The DEIF AGC 150 controller series has two RS485 ports, of which Port 1 is galvanically isolated. Galvanic isolation prevents so-called ground loops, which can otherwise lead to damage to the devices due to unwanted currents. Therefore, Port 1 must be used, as explained in the table.

After connecting the controller to the GX device, use the controller's display and navigate to Parameters → Communication → RS485 → RS485 1 → Parameters, enter the master password (default is '2002') and set the parameters as follows:

- Addr: **1**
- Speed: **115200 Baud**
- Type: **Modbus Slave**

DEIF AGC 150	Victron RS485-to-USB Interface	Signal
33: Data + (A)	Orange	RS485 Data A+
34: Data (GND)	Black	GND
35: Data - (B)	Yellow	RS485 Data B-
	Red	5VDC (not used)
	Brown	Terminator 1 – 120 Ω (not used)
	Green	Terminator 2 – 120 Ω (not used)



GX device configuration

Once the GX device and the genset controller are connected, it will automatically appear in the Device list.

If using the Ethernet method and it does not show up, check the Modbus settings on the GX device, Settings → Integrations → Modbus Devices, and ensure Automatic scanning is enabled (default setting) or scan for it; it should be automatically detected and appear in the Discovered devices sub-menu. For this to work reliably, automatic scanning must remain switched on. The network is scanned every ten minutes. If the IP address changes, the device will be found again. It is nevertheless advisable to assign a static IP address to the controller to prevent unexpected communication loss.

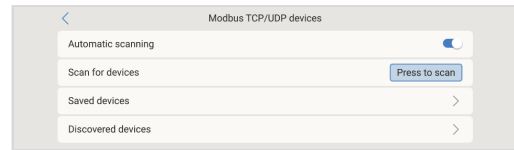

18.10. Fischer Panda Generator support

18.10.1. Introduction

The GX device reads from and sends data to the Fischer Panda generator via a VE.Can connection, using the Fischer Panda SAE J1939 module (required). Both AC and DC generators are supported.

18.10.2. Requirements

- GX device with firmware v2.07 or later
- Fischer Panda generator, xControl, iGenerator or fpControl GC
- Fischer Panda SAE J1939 CAN module (part number 0006107)
- Fischer Panda FP-Bus to VE.Can adapter (part number 0023441)
- Optional: FP-CAN to NMEA2000 (FP Art. No 0031409)

Fischer Panda firmware requirements:

- iControl (for the iGenerator): v2.17 or higher
- iControl panel: no minimum requirement
- xControl (for the constant speed generators): 4V38 or higher
- xControl panel: 4V29
- fpControl (for AC and DC generators): any version
- fpControl Panel: 4V29 or higher
- Fischer Panda SAE J1939 CAN module: 2V05 or higher
- Fischer Panda three-phase module: 4V0b or higher
- Fischer Panda NMEA2000 interface: 2V11 or higher

18.10.3. Installation and configuration

Connecting a Fischer Panda xControl generator

The schematic below shows how to connect a Fischer Panda xControl generator.

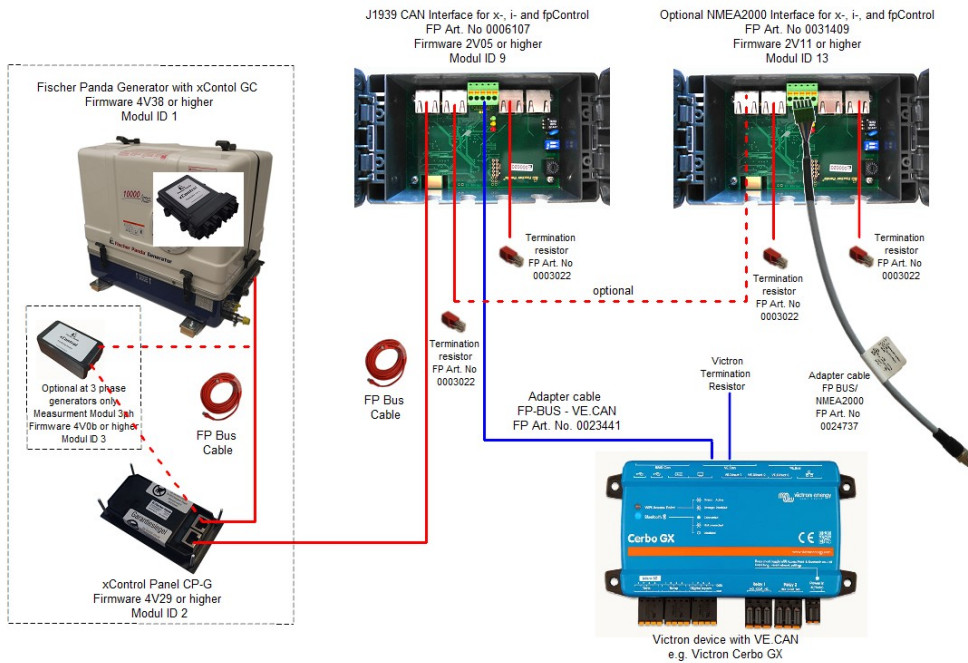

Connecting a Fischer Panda iControl generator

The schematic below shows how to connect a Fischer Panda iControl generator.

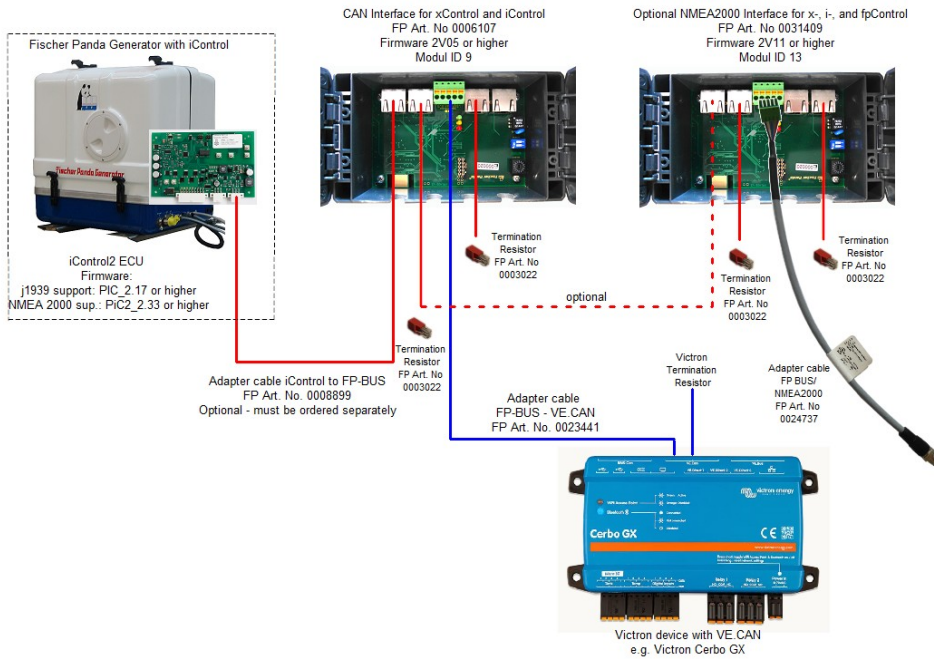

Connecting a Fischer Panda fpControl generator

The schematic below shows how to connect a Fischer Panda fpControl generator.

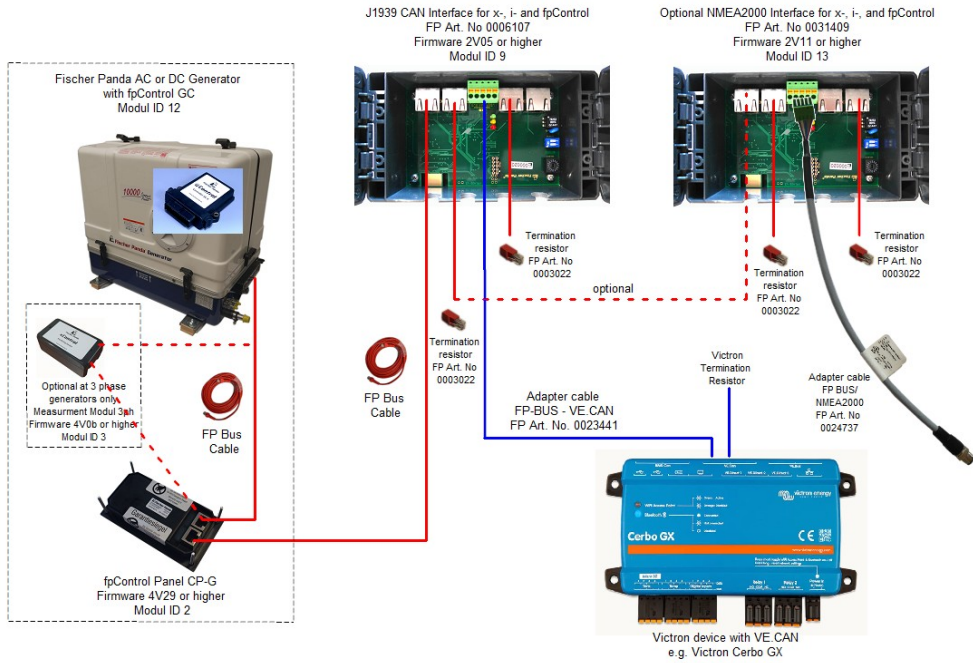

18.10.4. GX device configuration and monitoring

Important: Operation of the generator is only possible and allowed when the xControl, or the fpControl or iControl panel is switched on.

Ensure that in Settings → Connectivity the selected CAN-bus profile is "VE.Can (250kbit/s)". This is the default and supports NMEA 2000.

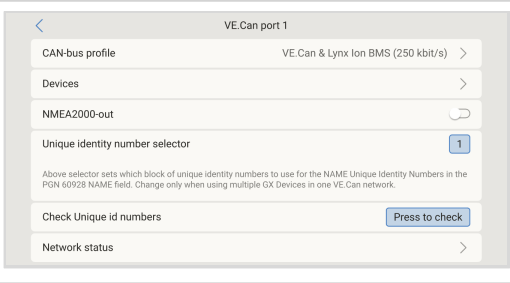

When all wiring is complete and the setup has been correctly carried out, the Fischer Panda will show up in the Device list:

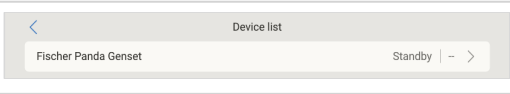

Entering the Fischer Panda device on the menu reveals a page like this:
Notice that it features an on/off switch as well as displaying status information, and the main AC parameters: voltage, current and power.



Engine temperature, RPM and additional information are all available by entering the Engine sub menu item.



Engine	
Speed	0RPM
Load	0%
Coolant temperature	66 °C
Exhaust temperature	77 °C
Winding temperature	78 °C
Starter battery voltage	12.90V

18.10.5. Maintenance

Before performing any maintenance on the generator, always stop it using the Fischer Panda control panel. This disables the autostart feature, preventing the generator from being remotely started, such as by a Cerbo GX.

After maintenance is complete, re-enable the autostart feature via the Fischer Panda control panel in the menu Generator → Autostart → Turn On/Off.

18.11. Hatz fiPMG DC Generator

18.11.1. Introduction

How does it work?

The Hatz fiPMG DC generator is a flywheel-integrated Permanent Magnet Generator (PMG) that adjusts to varying load levels with variable speed. It is powered by a Hatz E1 diesel engine with electronically controlled injection.

The Power Supply Unit provides adjustable output voltages for 28 Volt or 56 Volt systems and communication between PSU – ECU – Victron GX device acc. SAE J1939.

The Double CAN inverter has two separate CAN ports:

- CAN port 1: Handles communication between the PSU (inverter) and the ECU of the engine.
- CAN port 2: Manages communication between the PSU and the GX device.

For further details, visit www.hatz.com where you can access all electrical diagrams and additional unit-specific information.

18.11.2. Requirements

- GX device with firmware Venus OS v3.50 or later
- Hatz fiPMG generator with Double CAN PSU (inverter) for DC output in 28V or 56V
- Cable VE-CAN to HATZ-CAN (available for purchase from HATZ)

18.11.3. Installation & Configuration

Connecting a Hatz fiPMG generator

The diagram below shows how to connect the Hatz fiPMG DC generator with the GX device.

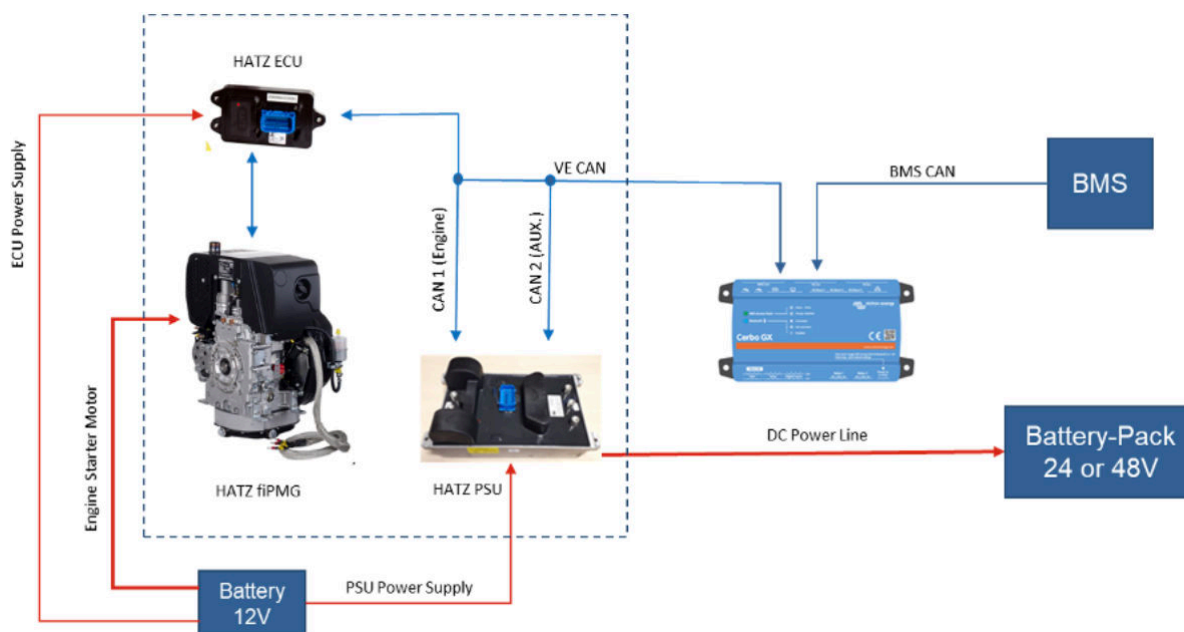

GX device configuration

Ensure that in Settings → Services the selected CAN-bus profile is "VE.Can (250kbit/s)". This is the default and supports NMEA 2000.

Once the GX device and the genset controller are connected, it will automatically appear in the Device list.

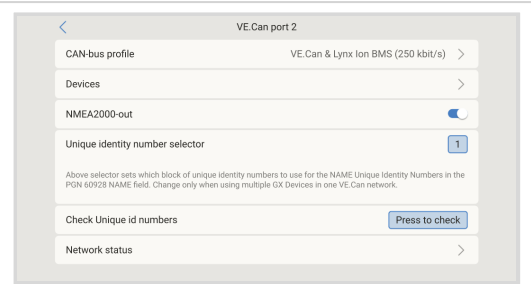

18.11.4. Maintenance

For maintenance instructions, refer to the fiPMG manual.

18.11.5. Troubleshooting

- PSU list of error codes: See www.hatz.com (CAN protocol E-series)
- ECU list of error codes: See www.hatz.com (Diagnostic trouble codes E-series)

18.12. Generator state and improved operating hours via a digital input

For accurate engine status and improved tracking of accumulated operating hours on the GX device, an additional dry-contact signal wire can be used.

There are two common wiring options:

- Using a potential-free output on the genset controller (if supported) to report the engine state.
- Using an AC helper relay on the generator's AC line, which closes a potential-free contact as soon as the genset starts supplying power.

To enable this feature, go to Settings → Integrations → Digital I/O and configure the respective input as "Generator".
Once configured, the generator state will be visible in the Device list, and the total run time will be determined based on the state of this digital input.

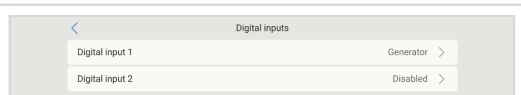

18.13. Wiring a generator with a three-wire interface

To start a generator with a three-wire interface, the open/close contact must be converted into separate start and stop pulses. The solution below, using standard timing relays, achieves this by:

- Generating a start pulse when the open/close contact closes.
- Generating a stop pulse when the open/close contact opens.

Important: This method should only be used with generators that have their own control panel for monitoring and automatically stopping in case of issues such as low oil pressure. **Do not wire this directly to the starter motor or fuel solenoid.**

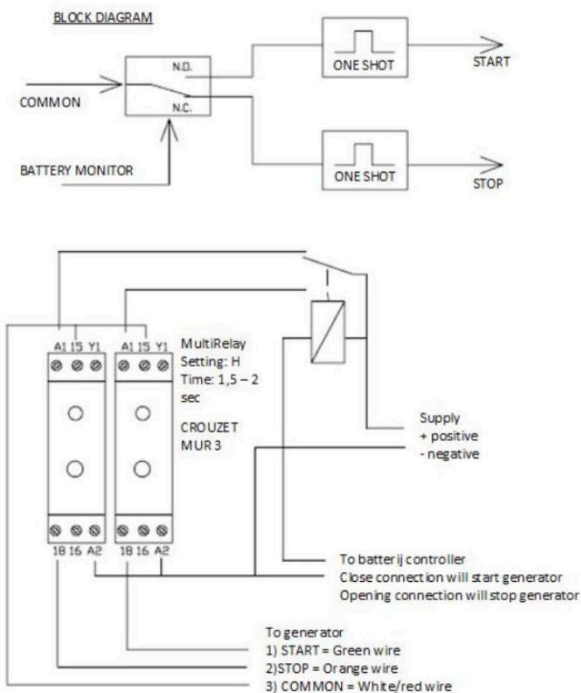

19. Reset to factory defaults and Venus OS reinstall

19.1. Reset to factory defaults procedure

A factory reset on a GX device is performed by inserting a USB stick or SD card containing a specific reset file. No buttons or display are needed.

Factory reset requires Venus firmware version 2.12 or higher.

How to reset to factory default

1. Download the [venus-data-90-reset-all.tgz](#) file.
2. Copy it (as-is: don't unzip or rename) onto a blank, FAT32-formatted USB stick or SD card.
 - For devices running v2.12–v3.10, only a single file can be executed. Either:
 - Update to a newer firmware version, or
 - Rename the file to `venus-data.tgz` before copying it.
3. Boot with the USB-drive/SD card inserted and wait until the GX device has fully started up.
4. Remove the USB-drive/SD card from the GX device.
5. Power cycle the device, or, alternatively and when available, use the Reboot function in the Settings → General menu.

Once restarted, all settings will be reset to factory defaults.

When to use a factory reset

Typical reasons include:

- The device is locked due to a forgotten Remote Console password on a model without a screen.
- A clean slate is desired by the user, even without specific issues.
- The device was used in a test environment, and residual data (e.g. discovered AC PV inverters) needs to be cleared.
- The GX device is behaving unexpectedly; a factory reset may rule out misconfigured settings as the cause.
- The data partition is full (usually due to manual modifications).
- A rare bug, often found in beta versions, may require a reset.

After the reset

- Previously saved Wifi access credentials will be reset - for devices without a physical interface and using WiFi to connect, consider how you will get access again to reconfigure.
- A factory reset may require resetting the VRM authorisation token. After the reset, open the site in VRM. If needed, a notification will appear with instructions.
- A factory reset does not affect the VRM site ID or stored data. To clear history before selling or reinstalling the device on another system, go to Site settings → General → Delete this installation in the VRM Portal.

19.2. Venus OS reinstall

Use this when the procedure described in [Reset to factory defaults procedure \[191\]](#) doesn't work.

WARNINGS:

- Before performing this procedure, first try the standard factory reset procedure as described in the previous section.
- Only perform this procedure as a last resort: to fix a bricked device. A device that boots fine but has some strange behaviour in some features will not benefit from executing this procedure.
- This procedure will wipe all data on the data partition, which means all settings and so forth.
- Unlike the common reset to factory default instructions, this procedure does not rely on a properly booting device.
- On the VRM Portal you'll have to reset the Device token. The portal will accept no new data until that is done.
- Ensure you have the appropriate manual for your GX device, as the procedures may vary slightly depending on the GX model.

PROCEDURE:

1. Download the installer image here: <https://updates.victronenergy.com/feeds/venus/release/images/ekran0/> (venus-install-sdcard-ekran0-*.img.zip)
2. Flash the image to a microSD card using the Balena Etcher application (<https://etcher.balena.io/>). The Etcher application automatically unzips the archive.
3. Insert the microSD card into the Ekran0 GX device.
4. Power up the device.
5. Wait for the installation process to finish. You will be asked to remove the installation medium (Micro SD card) and to power-cycle the system.

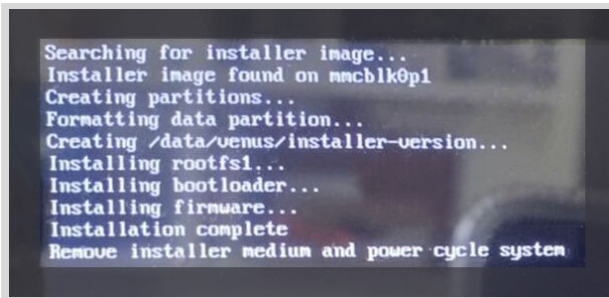

6. Remove the microSD card and power-cycle the device.

20. Troubleshooting

20.1. Error Codes

Different origins of errors

The GX device can display its own error codes, as well as those from connected devices. For device-specific codes, refer to:

- Multi and Quattro inverterchargers: [VE.Bus Error Codes](#)
- MPPT Solar Chargers: [MPPT Solar Charger Error Codes](#)

GX Error #42 - Storage corrupt

The internal flash memory is corrupt. This partition stores settings, serial numbers, and Wi-Fi credentials. This partition stores settings, serial numbers, and WiFi credentials.

- Solution: The device must be returned for repair or replacement. This cannot be fixed via firmware or in the field.

GX Error #47 - Data partition issue

The internal storage is likely damaged, causing the device to lose configuration.

- Solution: Contact your dealer or installer. See our [Victron Energy Support](#) page.

GX Error #48 - DVCC with incompatible firmware

DVCC is enabled, but not all system components are running compatible firmware.

- Solution: Refer to the [DVCC chapter \[111\]](#) of this manual for firmware requirements.

• Note for systems with Pylontech and BMZ batteries:

Since Venus OS v2.80, DVCC is enforced for Pylontech and BMZ batteries. Older systems may show this error.

Solution:

- Disable automatic updates; Settings → General → Firmware → Online updates → Auto update.
- Roll back to v2.73 (see [Install a specific firmware version from SD/USB \[104\]](#)).
- And after that, consider having an installer update all device firmware.
- **Note for systems with BYD, MG Energy Systems and Victron Lynx Ion BMS batteries:**
Since Venus OS v2.40, DVCC auto-enables for supported BMS types. Older systems may lack components to support this.
Solution:
 - Disable automatic updates; Settings → General → Firmware → Online updates → Auto update.
 - Roll back to v2.33; to roll back to a previous firmware version see [Install a specific firmware version from SD/USB \[104\]](#).
 - Ensure DVCC is disabled.

Consult your installer to check if your system uses two-wire control (earlier alternative to DVCC).

If there are no charge/discharge wires between BMS, inverterchargers, and charge controllers, DVCC is required for the above-mentioned battery brands. This also requires minimum firmware versions on connected devices.

GX Error #49 - Grid meter not found

In ESS setups with External Grid Meter selected, no meter was detected.

Solution: Check system wiring and configuration.

GX Error #51 - mk3 firmware needs update

Update the MK3 controller inside the GX device to enable recent features like generator start/stop warm-up/cooldown.

To update:

- Go to Settings → Devices → MultiPlus/Quattro/EasySolar.
- A notification there indicating a new MK3 version is available. Tap the notification and start the update

There is a small chance, around 5% based on our data, that this update may briefly restart the system, causing the inverter/charger to cycle off and on.

If no update prompt appears, your system is already up to date. This manual update is only required once and was designed to be user-initiated due to the small restart risk. Future updates will install automatically without causing a restart.

GX Error #60 – Could not connect to the GX device

This error occurs when the Marine MFD app fails to establish a connection with the GX device.

- To resolve the issue, try rebooting the GX device and/or the MFD.

20.2. FAQ

20.2.1. Q1: I cannot switch my Multi/Quattro system on or off

To solve the problem, first find out how the system is connected, and then follow the right step by step instruction below. There are two ways to connect a Multi/Quattro system to a Ekran GX. In most systems they will be connected directly to the VE.Bus port on the back of the EGX. And, option two, in some systems they are connected to the Ekran GX using a [VE.Bus to VE.Can interface](#).

Step by step instructions when connected to VE.Bus port on the EGX

1. Update the Ekran GX to the latest available version.
See our blog posts in the <https://www.victronenergy.com/blog/category/firmware-software/>.
2. Do you have a Digital Multi Control or VE.Bus BMS in the system? In that case it is normal that on/off is disabled.
See also the VE.Bus related notes in the [EGX manual \[25\]](#).
3. In case you have had a Digital Multi Control or VE.Bus BMS connected to your system, the Ekran GX remembers it and even when those accessories have been removed, the On/Off switch will still be disabled. To clear the memory, execute a Redetect system in the Remote Console menu for your Multi or Quattro.
For details see the [Advanced menu \[107\]](#) section.
4. For parallel/three-phase systems consisting of more than 5 units: depending on temperature and other circumstances, it might not be possible to switch a system back on after switching it off with the EGX. As a work around you'll need to unplug the VE.Bus cable from the back of the EGX. And plug it back in after starting the VE.Bus system. The real resolution is to install the "EGX dongle for large VE.Bus systems", partnumber BPP900300100. For details, read its [connection instruction](#).

Step by step instructions when connected to EGX via VE.Can.

1. Update the Ekran GX to the latest available version. See our blog posts in the firmware category.
2. Update the VE.Bus to VE.Can interface to the latest version. The easiest way to do that is by using Remote firmware update: having a special piece of hardware, the CANUSB, is then not necessary.
3. Do you have a Digital Multi Control or VE.Bus BMS in the system? In that case it is normal that on/off is disabled. See also the VE.Bus related notes in the EGX manual
4. In case you have had a Digital Multi Control or VE.Bus BMS connected to your system, and it is now no longer connected, the Canbus interface remembers it. Therefore, even after those accessories have been removed, the On/off switch will still be disabled. Clearing this memory is unfortunately not possible yourself, please contact us so we can help you.

20.2.2. Q2: Do I need a BMV to see proper battery state of charge?

It depends. For details see the [Battery state of charge \(SoC\) \[97\]](#) chapter.

20.2.3. Q3: I have no internet. Where can I insert a SIM card?

GX devices do not have a built-in 3G or 4G modem, and therefore do not include a SIM card slot.

To connect to the internet via mobile data, purchase a mobile router with Ethernet ports. These devices handle the SIM card and provide an internet connection to the GX device over Ethernet.

20.2.4. Q4: Can I connect both a GX Device and a VGR2/VER to a Multi/Inverter/Quattro?

No, this is not possible.

Instead of this combination, we recommend using a GX device together with a GX LTE 4G or mobile router. See [Internet connectivity \[77\]](#) for more information.

20.2.5. Q5: Can I connect multiple Ekran GX to a Multi/Inverter/Quattro?

No.

20.2.6. Q6: I see incorrect current (amps) or power readings on my EGX

Examples are:

- I know that a load is drawing 40W from the Multi, but the EGX shows 10W or even 0W.
- I see that the Multi is supplying a load with 2000W, while in inverter mode, but from the battery only 1850W is being taken. Is those 150W coming out of nowhere?

The general answer is: the Multi and Quattros are not measurement instruments, they are inverter/chargers, and the measurements shown are a best effort delivery.

In more detail, there are several causes for measurement inaccuracies:

1. Part of the power taken from a battery by the inverter is being lost in the inverter, converted into heat: efficiency losses.
2. The Multi does not really measure the power being drawn from the battery. It measures the current at the output of the inverter, and then makes an assumption of the power being drawn from the battery.
3. Watts vs VA: depending on the Multi/Quattro firmware version and also the EGX firmware version, you are either looking at VAs (the result of calculating AC voltage * AC current) or looking at a Watts measurement. To see WATTS on the EGX, update your EGX to the latest version (v1.21 or newer). Also make sure the firmware version in your Multi supports Watts readout, minimum versions are xxxx154, xxxx205 and xxxx300.
4. Multis/Quattros connected to the EGX via a VE.Bus to VE.Can interface will always reports VAs, not (yet) Watts.
5. If a current sensor assistant is loaded in a Multi/Quattro and no sensor is connected it will return invalid power / kWh values.
6. If a current sensor assistant is loaded in a Multi/Quattro make sure the position is set correctly and the scale match with the dipswitches on the sensor itself.
7. A current sensor assistant measures and reports VAs, not Watts.

Tips to prevent measurement problems

1. While VEConfigure or VictronConnect is connected via an MK3 interface, both programs periodically send a command that blocks communication to the GX device. During this time, it cannot read any data, including measurements, from the Multi or Quattro. Once VEConfigure or VictronConnect is closed, communication between GX device and the Multi/Quattro is restored.
2. VE.Bus is not a 100% plug and play system: if you disconnect the EGX from one Multi, and very quickly connect it to another, it can result it wrong values. To make sure that this is not the case, use the 'redetect system' option in the Multi/Quattro menu on the EGX.

20.2.7. Q7: There is a menu entry named "Multi" instead of the VE.Bus product name

A VE.Bus system can be completely turned off, including its communication. If you turn a VE.Bus system off, and thereafter reset the EGX, the EGX cannot obtain the detailed product name and shows "Multi" instead.

To get the proper name again, go into the Multi menu on the EGX and set the Switch menu entry to On or in case a Digital Multi Control is present, set the physical switch to On. Note that when there is a BMS, above procedure only works when within battery working voltages.

20.2.8. Q8: There is a menu entry named "Multi", while there is no Inverter, Multi or Quattro connected

If a EGX ever saw a VE.Bus BMS or Digital Multi Control (DMC), it will remember them, until 'Redetect system' is started from the EGX menu. After a minute, restart the EGX: Settings → General → Reboot.

20.2.9. Q9: When I type the IP address of the Ekran GX into my browser, I see a web page mentioning Hiawatha?

Our plan is to at least run a website where you can change settings and see the current status. If all works out as we would like to, there might come be a fully functional version of the online VRM Portal running locally on the Ekran GX. This allows people without an internet connection, or an intermittent internet connection to have the same features and functionality.

20.2.10. Q10: I have multiple Solar chargers MPPT 150/70 running in parallel. From which one will I see the relay status in the EGX menu?

From a random one.

20.2.11. Q11: How long should an automatic update take?

The size of the download typically is around 90MB. After download it will install the files which can take up to 5 minutes.

20.2.12. Q12: I have a VGR with IO Extender, how can I replace this with a Ekran GX?

It is not yet possible to replace the IO Extender functionality.

20.2.13. Q13: Can I use Remote VEConfigure, as I was doing with the VGR2?

Yes, see [VE Power Setup manual](#)

20.2.14. Q14: The Blue Power Panel could be powered through the VE.Net network, can I also do that with a Ekran GX?

No, a Ekran GX always needs to be powered itself.

20.2.15. Q15: What type of networking is used by the Ekran GX (TCP and UDP ports)?**Basics:**

- The Ekran GX requires a valid IP address, DNS server, and gateway (default via DHCP, manual configuration possible).
- DNS: Port 53 UDP/TCP.
- NTP (time sync): UDP port 123 (uses ntp.org server pool).

VRM Portal:

- Both in 'VRM read-only' mode and 'VRM full' mode, data is transmitted to the VRM Portal via HTTPS POST and GET requests to <https://ccgxlogging.victronenergy.com> on port 443. There is an option in the menu to use HTTP instead, port 80. Note that in that case it will still send sensitive data such as related access keys (required for 'VRM full' mode) over HTTPS/443.

Additionally in 'full' mode:

- Outbound MQTT-over-TLS connections are made to mqtt-rpc.victronenergy.com and mqtt{0 to 127}.victronenergy.com, on port 443.
- An outbound SSH connection is made to supporthosts.victronenergy.com. The supporthosts.victronenergy.com DNS record resolves to multiple IP addresses, and the DNS uses Geo-Location to resolve it to the nearest server. This outbound SSH connection tries multiple ports: port 22, port 80 or port 443. The first that works is used, and in case it loses connection it will retry them all again. More information about the Remote Support feature is in the next FAQ item.

In 'read-only' mode:

- The outbound SSH connection described above is also enabled in 'read-only' mode, but only when 'remote support' is enabled. More information about the Remote Support feature is in the next FAQ item.

No port-forwarding or other internet router configuration is necessary to use these features.

More information about troubleshooting Remote Console on VRM is in here: [Remote Console on VRM - Troubleshooting \[126\]](#).

Firmware updates:

- The EGX connects to <https://updates.victronenergy.com/> on port 443.

MQTT on LAN:

- When enabled, a local MQTT broker is started. Depending on the configured 'security profile', it will accept TCP connections on port 8883 (SSL), and also 1883 (plain text) when using the 'weak' or 'unsecured' security profiles.

Remote Console on LAN:

- GX devices that have no physical way to be configured, have a web console available on HTTPS, port 443. When the security profile is set to 'weak' or 'unsecured', this will also be available on port 80, unencrypted.

Modbus TCP:

- When enabled, the ModbusTCP server listens on the common designated port for Modbus TCP, which is 502.

SSH Root Access:

- Port 22 - see the [Venus OS root access documentation](#).
- This is a software developers feature.

20.2.16. Q16: What is the functionality behind the menu item Remote support in the General menu?

Enabling remote support grants Victron Engineers access the device for diagnostics and troubleshooting over the reverse SSH tunnel that is maintained when the GX's VRM mode is set to full. If the VRM mode is not set to full, the tunnel will be set up specifically for remote support.

The connection uses ports 80, 22, or 443 to supporthosts.victronenergy.com and works behind most firewalls. Remote support is disabled by default.

20.2.17. Q17: I don't see support for VE.Net products in the list, is that still coming?

No.

20.2.18. Q18: What is the data usage of the Ekran GX?

Data usage varies greatly depending on the number of connected products, system behaviour, logging interval, VRM access mode, and features like Remote Support or update checks.

If you're on a limited data plan, monitor usage during normal operation. Most routers offer built-in traffic counters; advanced tools like Wireshark provide detailed tracking.

20.2.19. Q19: How many AC Current Sensors can I connect in one VE.Bus system?

The current maximum is 9 sensors (since Ekran GX v1.31). Note that each need to be configured separately with an assistant in the Multi or Quattro to which it is wired.

20.2.20. Q20: Issues with Multi not starting when EGX is connected / Caution when powering the EGX from the AC-out terminal of a VE.Bus Inverter, Multi or Quattro

Ensure that both the GX device and the MultiPlus are running the latest firmware.

If the GX device is powered via an AC adaptor connected to the AC-out of a VE.Bus Inverter, Multi or Quattro, a deadlock can occur after the VE.Bus device is powered down, for example, during a black start or fault. In this state, the VE.Bus product will not start until the GX device is powered, but the GX device cannot start without power either.

How to resolve the deadlock

Unplug the VE.Bus cable from the GX device briefly. The VE.Bus device will immediately begin to boot.

How to avoid the deadlock

There are two options:

- Power the GX device directly from the battery
- Remove pin 7 in the VE.Bus cable connected to the GX device. Removing pin 7 allows the VE.Bus device to start independently of the GX device.

The fastest and easiest way to remove this pin is with a very thin flat head screwdriver. This can be inserted into the pin groove, and then used to leverage out the gold contact plate. Be aware that this small highly conductive plate will fall out, so this should not be done over the open unit.



When using a Redflow ZBM2/ZCell battery, pin 7 should be removed even if the GX device is DC powered, to prevent deadlocks when the battery cluster reaches 0% SoC.



Consideration when removing pin 7

Removing pin 7 disables the ability of the GX device to fully switch off the VE.Bus device. The unit will stop charging and inverting, but will remain in standby, drawing more power than if pin 7 were intact. This is primarily relevant in marine and automotive systems, where devices are routinely switched off. In such cases, **do not remove pin 7**, and instead power the GX device from the battery directly.

20.2.21. Q21: I love Linux, programming, Victron and the EGX. Can I do more?

Yes you can! We intend to release almost all code as open source, but we are not that far yet. What we can offer today is that many parts of the software are in script or other non-compiled languages, such as Python and QML, and therefore available on your Ekrano GX and easy to change. Root password and more information is available [here](#).

20.2.22. Q23: Multi restarts all the time (after every 10sec)

Please check the remote switch connection on the Multi control PCB. There should be a wire bridge between the left and middle terminal. The EGX switches a line which enables the power of the Multi control board. After 10 seconds this line is released and the Multi should take over from there. When the remote switch connection is not wired, the Multi is unable to take over it's own supply. The EGX will retry, the Multi will boot and after 10 seconds stop, and so on.

20.2.23. Q24: What is Error #42?

Error #42 – Hardware fault indicates corrupt flash storage on the GX device. This prevents settings from being saved. After a reboot, all settings revert to defaults, and may lead to further issues.

△ This fault is not field-repairable and cannot be fixed by service departments. Please contact your dealer to arrange a replacement.

Note: Firmware versions prior to v2.30 did not report this error. Since v2.30, Error #42 is visible both on the device GUI and in the VRM Portal.

20.2.24. Q25: My GX device reboots itself. What is causing this behavior?

There are several reasons why a GX device may reboot itself.

One of the most common causes is loss of communication with the VRM online portal.

However, this is only true if the "Reboot device when no contact" option (disabled by default) has been enabled in the VRM online portal settings. If there is no contact with the VRM portal for the time period set in 'No contact reset delay', the GX device will automatically reboot. This process is repeated until communication with the VRM portal is restored. See also [chapter Datalogging to VRM \[121\]](#) - Network watchdog: auto-reboot.

1. Check the network connection between your GX device and the router. See [Troubleshooting data logging \[122\]](#).
2. Preferably use an ethernet connection between your GX device and the router.
3. Tethered or hotspot connections, e.g. with a cell phone, are not reliable and are often interrupted or do not automatically restore the connection once it has been lost. Therefore, this is not recommended.

Other common reasons that cause the GX device to automatically restart are:

- System overload (either CPU, memory, or both).

To reliably detect an overload of the system, there is the D-Bus round trip time (RTT) parameter, and this parameter is available on the VRM Portal. See image below how to set this up on VRM.

An RTT value between 1 and 100ms is fine, although 100ms is already quite high.

RTT peaks occurring now and then are not a problem. Permanently over 100ms is a problem and requires further investigation.

In case the cause is a system overload, then there are two solutions:

1. Disconnect devices to reduce the load, with associated disadvantages.
2. Or change the GX device for a more powerful one. In the current product offering - see our [Victron GX product range](#) -, the Cerbo GX & Cerbo-S GX is (far) more powerful than the Venus GX.



An occasional reboot is not causing any harm to system longevity or performance. The main effect is (temporary) disturbance of the monitoring.

How to create a custom widget in the VRM portal to read out D-Bus round trip time:

1. Connect to the VRM Portal using a browser.
2. Click on the Advanced tab in the menu on the left side.
3. Click on the widget icon in the top right corner.
4. Scroll down to Custom Widget and click on it to create a new custom widget.
5. Give it a proper name, chose "Gateway" from the list in Select device and "D-Bus round trip time" in Select parameter.
6. After clicking on the Save button, the new widget will appear under the Advanced tab.

Tip: Keep the time period to be examined as small as possible to achieve a high resolution of the round trip time.

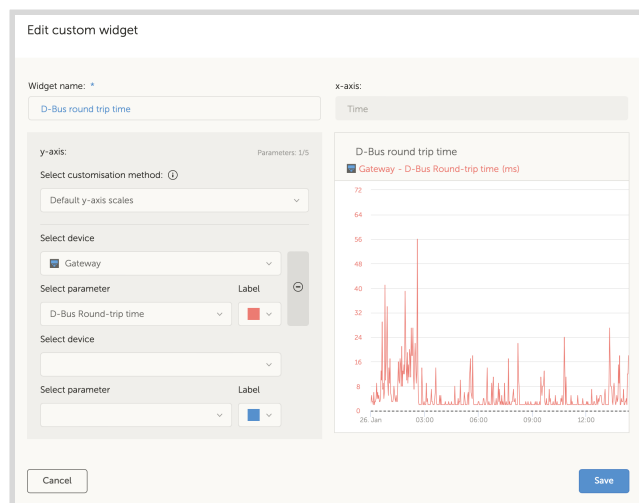

20.2.25. GPL Note

The software included in this product contains copyrighted software that is licensed under the GPL. You may obtain the Corresponding Source code from us for a period of three years after our last shipment of this product.

21. Technical specifications

21.1. Technical specifications

Ekran GX ^[1]	
Supply voltage	8 - 70V DC
Power draw display on (100% brightness)	6.2W @ 12V 6.6W @ 24V 7.4W @ 48V
Power draw display off	2.6W 12V 3.0W @ 24V 3.7W @ 48V
Relay	2 x NO/NC ^[2] DC up to 30VDC: 3A AC: 1A, 125VAC
Communication ports	
VE.Direct ports (always isolated)	3 (max. possible VE.Direct devices: 25) ^[7]
VE.Bus (always isolated)	1 bus with 2 paralleled RJ45 sockets
VE.Can 1	Yes - isolated
VE.Can 2	Yes – non-isolated
Ethernet	Yes
WiFi	Yes
Wifi Frequencies and Power	2.4GHz Wifi Range: 2.412-2.462GHz 88.1mW
Bluetooth Smart	Yes ^[3]
Bluetooth Frequencies and Power	Range: 2.402-2.48GHz 5.2mW
USB Host ports	Yes – 2 x USB-A (max. 1.5A@5V combined)
MicroSD Card Slot	Yes – SDHC cards up to max. 32GB
IO	
Resistive tank level inputs	3 ^[4]
Temperature sense inputs	2 ^[5]
Digital inputs	2 ^[6]
Display	
Display resolution	1024 x 600 pixels
Display max. backlight brightness	1000cd/m ²
Backlight dimming	Yes – dynamic via built-in ambient light sensor or manually via Remote Console With timer for auto on/off
Touch toggle on/off button	Yes – recessed button on the back (prevents unauthorised use)
Dimensions	
Outer dimensions (h x w x d)	124 x 187 x 29.8 mm 4.88 x 7.36 x 1.17 in (without connectors and mounting accessories)
Operating temperature range	-20 to +50°C
Other	
Mounting	Panel integrated flush mount or blind hole mount with included mounting accessories
Buzzer	Yes
Protection category	Front: IP54 (when installed with steel bracket) - IP31 (when installed with springs) Back: IP21

Ekran GX ^[1]	
Standards	
Safety	IEC 62368-1
EMC	EN 301489-1, EN 301489-17
Automotive	ECE R10-6

^[1] For more detailed information about the Ekran GX, please visit the [Victron GX product range page](#).

^[2] Currently, Relay 1 can be used for programming as an alarm relay, generator start/stop, tank pump, temperature controlled relay or manual operation. Relay 2 is available for programming as a temperature controlled relay or manual operation in the Relay menu of the GX (requires firmware 2.80 or higher).

^[3] Bluetooth functionality is intended to be used to assist with initial connection and networking configuration. You cannot use Bluetooth to connect to other Victron products (e.g. SmartSolar charge controllers).

^[4] The tank level inputs are resistive and should be connected to a resistive tank sender. Victron does not supply tank senders. The tank level ports can each be configured to work with either European (0 - 180 Ohm); or US tank senders (240 - 30 Ohm).

^[5] The Ekran GX has 2 temperature inputs. They can be used to measure & monitor all kinds of temperatures. Temperature senders are not included. The required sensor is ASS000001000 - Temperature Sensor QUA/PMP/Venus GX. (Note that this is not the same as the BMV temperature accessory.). Temperature range is -20C to +70C. Actually it can measure up to 100°C, but the sensor is not made to withstand temperatures above 70°C long term. Note that this is intended as a crude temperature sensor, and not calibrated. A deviation of +/- 2C is to be expected.

^[6] The digital inputs can be used for open/closed monitoring of alarms, for example doors, or fire- or bilge alarms and can also be used for pulse counting. See the product manual for electrical specifications of the digital inputs.

^[7] The listed maximum in above table is the total connected VE.Direct devices such as MPPT Solar Charge controllers. Total means all directly connected devices plus the devices connected over USB. The limit is mostly bound by CPU processing power. Note that there is also a limit to the other type of devices of which often multiple are connected: PV Inverters. Up to three or four three phase inverters can typically be monitored on a CCGX. Higher power CPU devices can monitor more.

21.2. Network Interfaces and Communication Services (RED 3.3d / EN 18031-1)

Network Interfaces

Interface	Purpose
Ethernet	Internet connectivity <ul style="list-style-type: none"> • Data logging to VRM website • Remote user interface (Remote Console) • Software updates
WiFi client	Internet connectivity <ul style="list-style-type: none"> • Data logging to VRM website • Remote user interface (Remote Console) • Software updates
WiFi Access Point (AP)	Remote user interface (Remote Console)
Bluetooth Low Energy peripheral	Setup network connectivity (Ethernet, Wifi client, Wifi AP)

Communication Services

Service	Purpose
HTTP webserver	Landing page to forward a user to the HTTPS login / Remote Console page
HTTPS webserver	Login page and Remote Console
MQTT via websockets	Data exchange between GX device and Remote Console
DHCP (on WiFi AP)	Providing IP addresses to connected clients
DNS (on WiFi AP)	Providing DNS functionality to connected clients
SSDP / DNS-SD	Make the GX device automatically detectable on the network
mDNS	Make the GX device reachable under the name venus.local

21.3. Compliance

SIMPLIFIED EU DECLARATION OF CONFORMITY: Hereby, Victron Energy B.V. declares that the Ekrano GX is in compliance with Directive 2014/53/EU. The full text of the EU declaration of conformity is available at the following internet address: <https://ve3.nl/7o>.

UK PSTI STATEMENT OF COMPLIANCE: We, Victron Energy B.V., confirm that our product Ekrano GX complies with the security requirements outlined in Schedule 1 of The Product Security and Telecommunications Infrastructure (Security Requirements for Relevant Connectable Products) Regulations 2023. The official Statement of Compliance can be downloaded from <https://ve3.nl/7o>.

22. Appendix

22.1. RV-C

22.1.1. Introduction to RV-C

The GX device offers integration with an RV-C network. The integration is split into two different types:

1. **RV-C out:** The GX device transmits data out to the RV-C network, where it can be read by connected displays and control centres. This includes data from Inverter/chargers, Battery chargers, Solar Chargers, batteries and more.
2. **RV-C in:** The GX device reads data from the RV-C network for displaying to the user (tank levels) as well as control (Lithionics batteries).

Further details with regards to supported messages (DGNs) for both RV-C out as well as RV-C in, is provided in the following sections.

To enable RV-C, select the RV-C profile for one of the VE.Can ports in the Settings → Connectivity menu.

A detailed specification of the protocol and message definition is publicly available on <https://www.rv-c.com>.

22.1.2. RV-C out

Generic

The GX main RV-C interface and all virtual devices report the minimum required DGNs:

DGN	DGN#	Description
PRODUCT_ID	0xFEED	Manufacturer, product name, serial number
SOFTWARE_ID	0xFEDA	Software version
DM_RV	0x1FECA	Diagnostics
DM01*	0x0FECA	Diagnostics

* In addition to DGN DM_RV 0x1FECA, also J1939 DGN DM01 0x0FECA is announced for all RV-C out devices to support older RV-C control panels that do not support the DM_RV DGN.

Main interface

The GX main interface identifies as "Control Panel" (DSA=68) on RV-C and is responsible for requesting and processing data from all RV-C nodes.

DC Source messages

All DC connected devices are capable of reporting DC_SOURCE_STATUS_1. This includes the inverter/charger, inverter, charger, battery and solar charger services. VE.Bus Inverter/charger and Battery/BMS reports DC current and voltage, all other devices report voltage only.

According to the RV-C spec, only one node is allowed to broadcast DC source messages from the same instance. Every device type has its own priority which is used to determine which node must send the DC source messages. Consider the following system:

- Inverter/charger (DC source instance 1, prio 100)
- Solar charger (DC source instance 1, prio 90)
- AC charger with 3 outputs (DC source instance 1, 2 & 3, prio 80)
- Battery monitor (DC source instance 1, prio 119)

In this case the battery monitor broadcasts DC source data with instance 1, as this has the highest priority. Additionally the AC charger broadcasts DC source data with instance 2 and 3 (output 2 and 3), as there are no other devices with those instances. More information about DC source messages in the [RV-C specification manual](#). Chapter 6.5.1 explains the priority mechanism.

VE.Bus Inverter/charger

Devices

Only VE.Bus MultiPlus/Quattro. Phoenix Inverter VE.Bus is also exported by this service, but then with the number of AC inputs set to 0. The DSA is set to 66 (Inverter #1).

Instances

Function	Default Instance	Configurable Range
Inverter	1	1..13
Charger	1	1..13
Line #1 (L1)	0	0..1
Line #2 (L2)	1	0..1
DC Source	1	1..250

Status

DGN	DGN#	Value
INVERTER_AC_STATUS_1	0x1FFD7	L1 AC out voltage, current, frequency L2 AC out voltage, current, frequency L2 data is not sent when not configured
INVERTER_AC_STATUS_3	0x1FFD5	L1 AC output power L2 AC output power L2 data is not sent when not configured
INVERTER_STATUS	0x1FFD4	Inverter status
CHARGER_AC_STATUS_1	0x1FFCA	L1 AC input voltage, current, frequency L2 AC input voltage, current, frequency L2 data is not sent when not configured
CHARGER_AC_STATUS_2	0x1FFC9	Input current limit
CHARGER_AC_STATUS_3C	0x1FFC8	L1 AC input power L2 AC input power L2 data is not sent when not configured Power is always positive, also in case of feed-in
CHARGER_STATUS	0x1FFC7	Charger state
CHARGER_STATUS_2	0x1FEA3	DC voltage, current Charger priority aligns with DC source priority
CHARGER_CONFIGURATION_STATUS	0x1FFC6	Maximum charge current
CHARGER_CONFIGURATION_STATUS_2	0x1FF96	Input current limit, Maximum charge current (%)
DC_SOURCE_STATUS_1	0x1FFFD	DC voltage, current Fixed priority of 100 (inverter/charger)
DC_SOURCE_STATUS_2	0x1FFFC	Battery temperature Fixed priority of 100 (inverter/charger)

Commands

DGN	DGN#	Value
INVERTER_COMMAND ¹⁾	0x1FFD3	Inverter enable/disable

DGN	DGN#	Value
CHARGER_COMMAND ¹⁾	0x1FFC5	Charger enable/disable
CHARGER_CONFIGURATION_COMMAND	0x1FFC4	Maximum charge current Note: this is a volatile setting and resets to the value the unit was configured with after a restart of the inverter/charger.
CHARGER_CONFIGURATION_COMMAND_2	0x1FF95	Charger input current limit

¹⁾ From RV-C you can control the charger and inverter part separately. These two on/off values are then combined into a single switch value (as seen on the VE.Bus page in the GX user interface, see top most item in below screenshot). If the inverter/charger is On, switching the charger off will result in Inverter only. Switching the inverter off will result in Charger only (when shore power is connected).

Victron defines the following options to control a combined inverter/charger:

State	Remarks
Off	Both, inverter and charger are switched off
Inverter only	Only the inverter is switched on
Charger only	Only the charger is switched on
On	Both, inverter and charger are switched on

This is reflected by the Switch menu option:

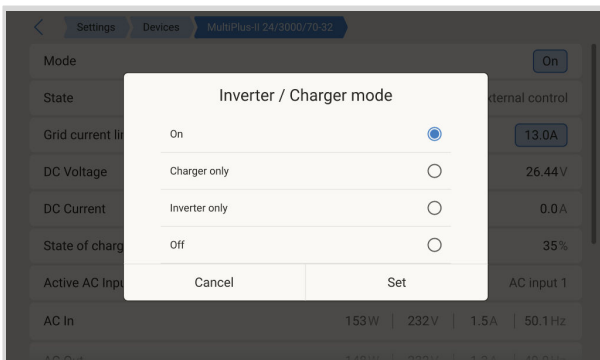

Inverter

Devices

Inverter VE.Direct and Inverter RS. The DSA is set to 66 (Inverter #1).

Instances

Function	Default Instance	Configurable Range
Inverter	2	1..13
Line (L1)	0	0..1
DC Source	1	1..250

Status

DGN	DGN#	Value
INVERTER_AC_STATUS_1	0x1FFD7	L1 AC out voltage, current, frequency
INVERTER_AC_STATUS_3	0x1FFD5	L1 AC out power
INVERTER_STATUS	0x1FFD4	Inverter status
DC_SOURCE_STATUS_1	0x1FFFD	DC voltage Fixed priority of 60 (inverter)

Commands

DGN	DGN#	Value
INVERTER_COMMAND	0x1FFD3	Inverter enable/disable/load sense

AC charger

Devices

Skylla-I, Skylla-IP44/IP65, Smart IP43 Charger. The DSA is set to 74 (Converter #1).

Instances

Function	Default Instance	Configurable Range
Charger	2	1..13
Line (L1)	0	0..1
DC Source #1	1	1..250
DC Source #2	2	1..250
DC Source #3	3	1..250

Status

DGN	DGN#	Value
CHARGER_AC_STATUS_1	0x1FFCA	AC current
CHARGER_AC_STATUS_2	0x1FFC9	Input current limit
CHARGER_STATUS	0x1FFC7	Charger state
CHARGER_STATUS_2	0x1FEA3	DC source #1: voltage, current output 1 DC source #2: voltage, current output 2 DC source #3: voltage, current output 3 Instance 2, 3 are not sent when not present Charger priority aligns with DC source priority
CHARGER_CONFIGURATION_STATUS_2	0x1FF96	Input current limit
DC_SOURCE_STATUS_1	0x1FFFD	DC source #1: voltage DC source #2: voltage DC source #3: voltage Instance 2, 3 are not sent when not present. Fixed priority of 80 (charger)

Commands

DGN	DGN#	Value
CHARGER_COMMAND	0x1FFC5	Charger enable/disable
CHARGER_CONFIGURATION_COMMAND_2	0x1FF95	Input current limit

Solar charger

Devices

BlueSolar, SmartSolar, MPPT RS. The DSA is set to 141 (Solar Charge Controller).

Instances

Function	Default Instance	Configurable Range
Charger	1	1..250
DC Source	1	1..250

Status

DGN	DGN#	Value
SOLAR_CONTROLLER_STATUS	0x1FEB3	Operating state
SOLAR_CONTROLLER_STATUS_5	0x1FE82	Total yield
SOLAR_CONTROLLER_BATTERY_STATUS	0x1FE80	Battery voltage, current
SOLAR_CONTROLLER_ARRAY_STATUS	0x1FDFF	PV voltage, current
DC_SOURCE_STATUS_1	0x1FFFD	DC voltage Fixed priority of 90 (charger + 10)

Battery/BMS

Devices

BMV, SmartShunt, Lynx Shunt, Lynx Ion, Lynx Smart BMS, BMS-Can batteries. The DSA is set to 69 (Battery State of Charge Monitor).

Instances

Function	Default Instance	Configurable Range
Main	1	0..120
Starter	2	0..120

Status

DGN	DGN#	Value
DC_SOURCE_STATUS_1	0x1FFFD	Voltage, current Starter instance not sent if starter battery is not present
DC_SOURCE_STATUS_2	0x1FFFC	Temperature, soc, time remaining
DC_SOURCE_STATUS_4	0x1FEC9	Desired maximum voltage, current, charge state Only sent for Lynx Smart BMS (NG)
DC_SOURCE_STATUS_6	0x1FEC7	HV limit/disconnect status, LV limit/disconnect status Only sent for Lynx Smart BMS (NG) and not adhering the 2s forewarning in case of a BMS disconnect
DC_SOURCE_STATUS_11	0x1FEA5	Discharge/charge on/off status, capacity, power Only sent for Lynx Smart BMS (NG) and not adhering the 2s forewarning in case of a BMS disconnect
DC_SOURCE_LOAD_CONTROL	0x1FDA8	Desired load state, minimum voltage, maximum current Only sent for Lynx Smart BMS (NG)

Tanks

Devices

Built-in tanks, GX tank, N2K tanks. The DSA is set to 73 (LPG) for LPG tanks and 72 (Water/Waste Tank System) for all other tank types.

Instances

Function	Default Instance	Configurable Range
Tank	0	0..15

Status

DGN	DGN#	Value
TANK_STATUS	0x1FFB7	Fluid type, relative level, absolute level, tank size Resolution fixed to 100

Commands:

DGN	DGN#	Value
TANK CALIBRATION COMMAND	0x1FFB6	Tank size

RV-C supports only 4 tank types (0..3), while Victron supports up to 11 tank types. The table with the additional tank types is Victron specific and is compatible with the tank types we use.

Supported tank types:

Venus / NMEA 2000		RV-C
Fluid type	Fluid code	Type
Fuel	0	4 (Vendor defined)
Fresh water	1	0
Waste (Grey) water	2	2
Livewell	3	5 (Vendor defined)
Oil	4	6 (Vendor defined)
Black water	5	1
Gasoline	6	7 (Vendor defined)
Diesel	7	8 (Vendor defined)
LPG	8	3
LNG	9	9 (Vendor defined)
Hydraulic oil	10	10 (Vendor defined)
Raw water	11	11 (Vendor defined)

Note that Vendor defined means that these types are not defined in RV-C, but only used for Victron RV-C devices.

Alternator

Devices

Orion XS and compatible third party alternator controllers, such as the Wakespeed WS500. The DSA is set to 76 (Charge Controller).

Instances

Function	Default Instance	Configurable Range
Charger	3	1..13
DC Source	1	1..250

Status

DGN	DGN#	Value
CHARGER_STATUS	0x1FFC7	Charger state, goal voltage (if available), goal current (if available), percentage (if available)
CHARGER_STATUS_2	0x1FEA3	Voltage, current Charger priority aligns with DC source priority
CHARGER_CONFIGURATION_STATUS	0x1FFC6	Battery sensor, max charging current
DC_SOURCE_STATUS_1	0x1FFFD	DC voltage Fixed priority of 70

Commands

DGN	DGN#	Value
CHARGER_COMMAND	0x1FFC5	Charger enable/disable

Generator auto start/stop**Devices**

Up to two GX generator auto start/stop instances can be expected, each with their own SA. One for the GX relay controlled instance and one for a connected genset, such as a Hatz. The DSA is set to 65 (Genstart Controller).

Instances

N/A

Status

DGN	DGN#	Value
AGS_DEMAND_CONFIGURATION_STATUS	0x1FED5	Disable on OEM Switch

Commands

DGN	DGN#	Value
AGS_DEMAND_CONFIGURATION_COMMAND	0x1FED4	Disable on OEM Switch
GENERATOR_DEMAND_CONFIGURATION_COMMAND	0x1FEE6	Disable on OEM Switch

Since these command DGNs are lacking instancing, all GX generator auto start/stop instances are affected.

22.1.3. DGN 60928 Unique Identity Numbers

The Unique Identity Number is used for the GX internal CAN-bus device "database" to compare devices during address determination.

To avoid clashes on CAN-Bus you must set the second GX device to the unique identity range of 1000-1499. This can be done by setting the unique identity selector to 2 ($2 * 500$). This works exactly the same as for VE.Can, see the [PGN 60928 NAME Unique Identity Numbers \[157\]](#) section.

The GX device will assign an individual Unique Identity Number to each virtual device. Change it only when using multiple GX devices in one RV-C network.

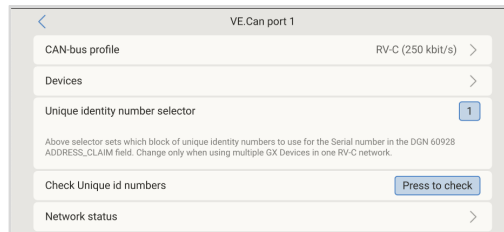

22.1.4. RV-C in

Tanks

Tested with Garnet SeeLevel II 709 and tanks from the RV-C out function of another GX device.

Batteries

Lithionics and BattleBorn are the only supported RV-C batteries (including DVCC support).

Alternators

Support for Wakespeed WS500(-PRO), ARCO Zeus and Revatek Altion and Altion MAX has been added since v3.xx. For integration with the Lynx Smart BMS (NG) over RV-C, it is mandatory to hardwire the allow-to-charge contact of the BMS to the alternator controller.

22.1.5. Device Classes

This section provides a basic overview of how each device class will participate in the RV-C specification. In any case, "Level 1" integration is largely supported (basic operation), with case-by-case enhancements.

AC standalone Chargers

- The AC-based charger class reports its operational status and configuration status using the CHARGER_xx group of RV-C messages. User control must include basic on/off switching via RV-C as well as adjusting shore (AC) power limits.

AC standalone Inverters

- This class of AC inverters reports its operational status using the INVERTER_xx group of RV-C reports. Incoming command is limited to on/off (enable/disable) via RV-C.

AC Charger / Inverter

- Combined inverter/charger - reports both CHARGER_xx and INVERTER_xx messages.

Solar Controllers

- Solar chargers will report their operational status in real time.

SOC Meters

- SOC meters can be used to report current battery health via RV-C: voltage, current, temperature, SOC, etc. RV-C requires that only ONE device speaks for a given battery at a time, so if a proper BMS is installed, that will be the data source.

BMS (Victron, or Victron 3rd party supported)

- In many cases, the battery(s) in the system will be directly attached to a Victron Cerbo GX or Cerbo-S GX, either via Victron equipment or via supported 3rd party compatible BMSs. Such batteries should be represented into the RV-C environment via the DC_SOURCE_STATUSxx messages.

Tank Level meters

- Tank meters will be translated into RV-C messages, carrying forward the existing tank ID/ VRM Instance numbers.

22.1.6. Instance Translation

RV-C utilises Instances in several ways:

- DC Source Instance
- AC Line
- Device Instance (context dependent)

Each usage of the Instance has a specific meaning, and a given device may at times utilise one or more of these instances.

DC Source Instance

In RV-C, a DC source is something that can generate and (optionally) store energy. Typically a battery but can also be a fuel cell or the output side of a DC contactor/disconnector.

A DC source can be thought of as a battery system and its associated physical bus, for example, the house battery, the DC bus bar and DC wiring. DC Source Instances are used to associate subsequent devices (e.g. a charger or an inverter) to the 'DC bus' it is connected to.

In this way it is possible to map out how all devices are connected with regards to their DC bus via their DC Source Instance value (starter battery and its alternator, house battery and its chargers etc.).

Note that in some cases (e. g. a DC-DC Converter or a Contactor), a device may be associated with two different DC Source instances. For example, a DC-DC converter could be associated with the two different batteries to which it is connected, while a contactor could be associated with the battery to which it is connected; the DC bus on the load side of the contactor then has its own DC Source instance

Though Victron is able to support more than one battery (a house and starter battery), the primary focus is on one battery. The dbus-rvc module will present the 'primary' battery to RV-C as 'DC Source Instance = 1' (house battery) information.

If present, additional Victron sensing devices will be presented using DC Source Instances of 2. An example is the optional starter battery voltage sensing on SmartShunts.

AC Line

AC line is much simpler, in that RV-C assumes a limited AC system, typically defined as Line 1 or Line 2. Victron supports 3-phase systems, which is not included in the RV-C specification. All installations with 3-phase systems are not supported by the dbus-RVC module and AC-related RV-C messages are suppressed.

Device Instance

Device Instance is a way to separate different physical devices of the same type. Example: if an installation contains two AC chargers attached to the same battery, each would be assigned a separate Device Instance while both would share the same DC Source Instance. Each charger would also be associated with an AC line, which may or may not be the same. In this way the AC charger is fully described in how it is wired on the AC and DC side while being able to be uniquely identified through its Device Instance.

Devices Instances are relevant within a given class of devices. An AC charger can define Device Instances 1 and 2, and these are unrelated to Device Instances 1 and 2 of a DC motor controller.



With the exception of tank monitoring, Device Instances are hard coded as 1 for each specific device class unless specified otherwise in the PGN table. Because the AC charger has a hardcoded instance of 2, to allow coexistence with an inverter/charger with charger instance 1.

22.1.7. RV-C Fault and Error Handling

RV-C fault reporting:

- Fault conditions are reported using the DM_RV (0x1FECA) and J1939 DM01 (0x1FECA) DGNs.
- In release 1 the operational status bits, the yellow and the red light field are supported because they are stored in DSA.
- SPN is set to 0xFFFFFFFF during normal conditions, and 0x0 at any time a warning or fault condition exists in supported Victron equipment.
- FMI is set of 0x1F (Failure mode not available) at all times.

This simple mapping allows external user displays to indicate an alarm or fault condition in a given Victron device, at which time the user should utilise Victron diagnostic aids for additional insight.

22.1.8. RV-C Device Priority

A critical concept in RV-C is the application of *Device Priorities*.

When used, a given device's priority will impact if it is allowed to transmit DGNs (e.g. a BMS with a higher priority should transmit details of the battery's status, while a MPPT controller with a lower priority should back down).

Device Priority is also at times used to allow for the favouring of one node vs. another, for example, it may be more desirable to use shore power AC vs. the inverter.

In the implementation of dbus-rvc, the following priorities will be hard coded into transmitted messages:

- DC_SOURCE_STATUS_xx messages: Priority = 119 (SOC/BMS) to allow native RV-C batteries have a higher priority.
- SOLAR_xx messages: Charger Priority = 110
- CHARGER_xx messages (Inverter/Chargers):: Charger Priority = 100
- CHARGER_xx messages (AC Chargers):: Charger Priority = 80

22.2. Ekrano GX Dimensions

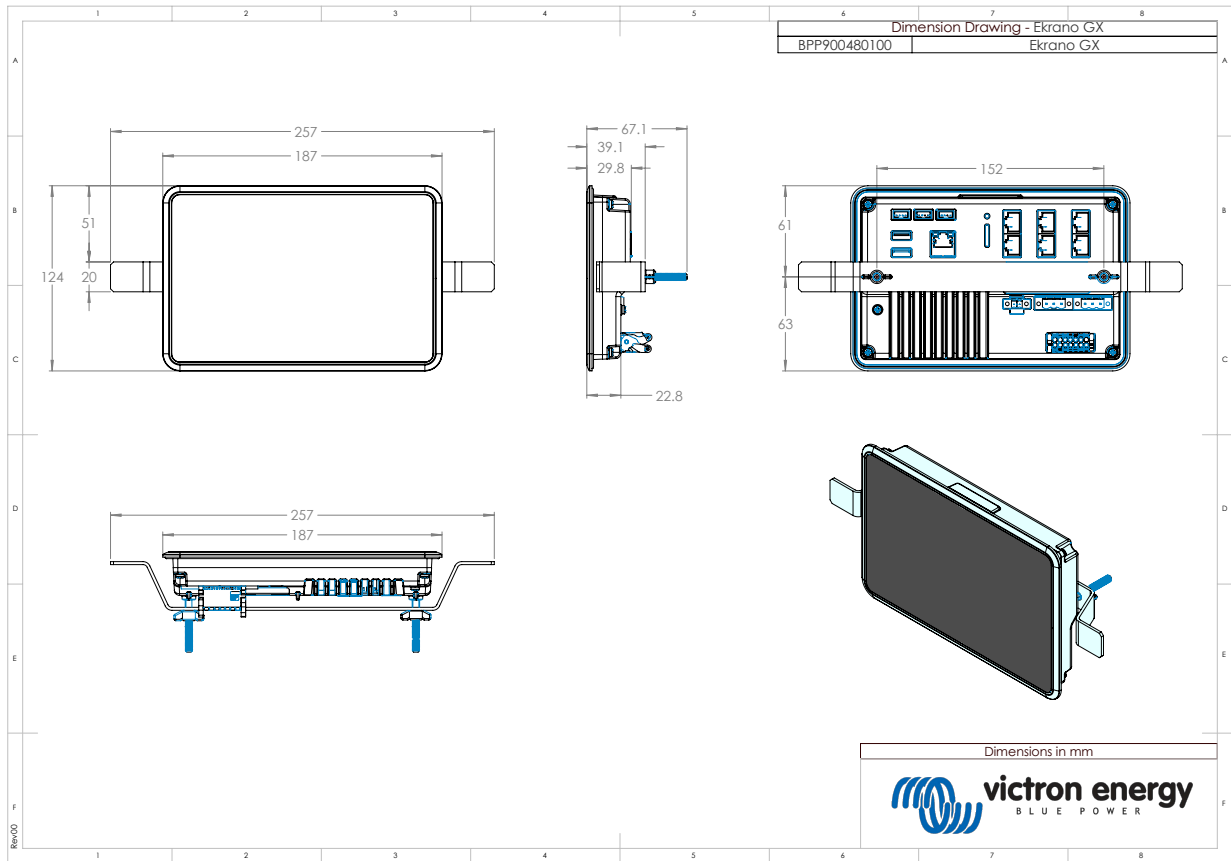

22.3. Ekrano GX cut-out template

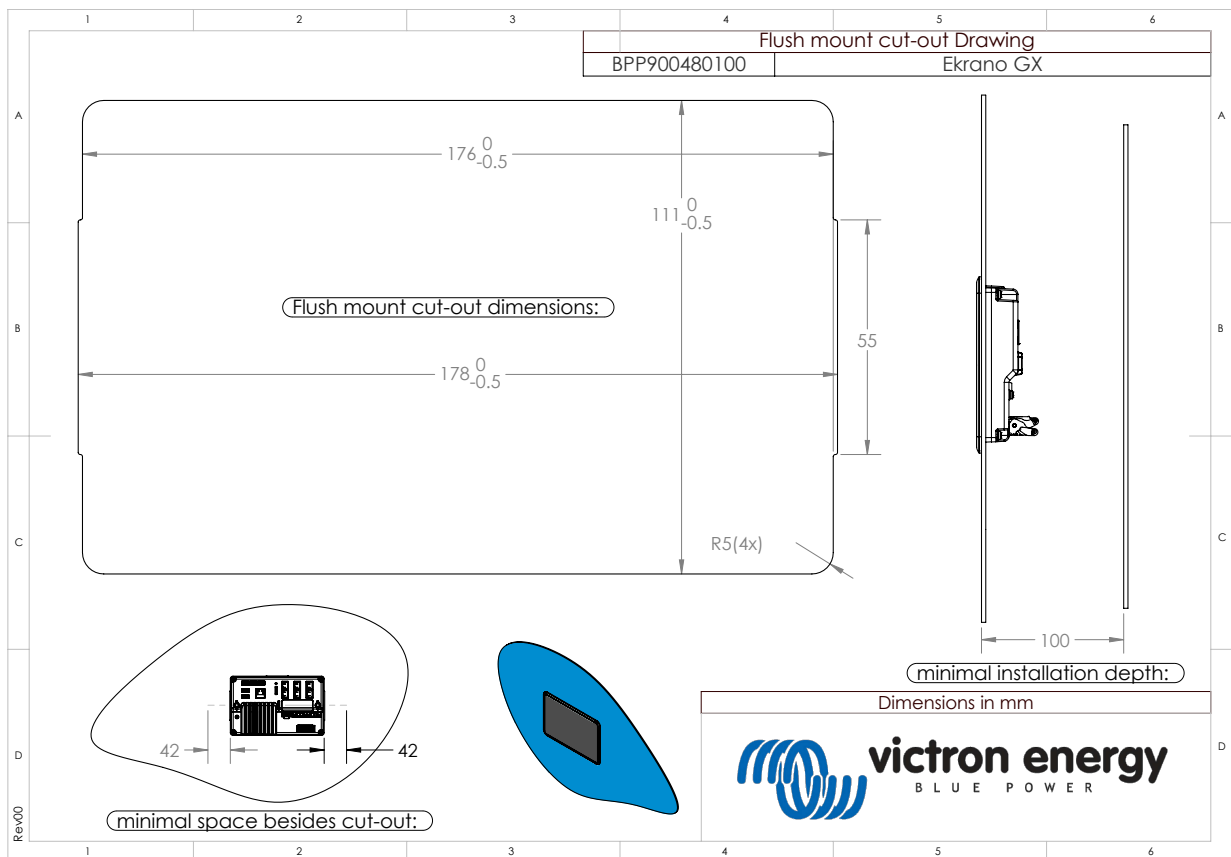

22.4. Modbus holding registers for the ComAp IntelliLite 4 controller

The following table lists the required ComAp Modbus configuration. In addition to the listed holding registers, Coil 4700 is used to start and stop the genset.

Table 1. Holding registers

Register(s)	Com. Obj.	Name	DIM	Type	Dec	Group
01004	10123	RPM	rpm	int16	0	Engine
01006	9152	T-Coolant	°C	int16	0	Controller I/O
01008	9151	P-Oil	bar	int16	1	Controller I/O
01013 - 01014	8206	Running Hours	h	int32	1	Statistics
01020	8202	Load P	kW	int16	0	Load
01021	8524	Load P L1	kW	int16	0	Load
01022	8525	Load P L2	kW	int16	0	Load
01023	8526	Load P L3	kW	int16	0	Load
01036	8210	Generator Frequency	Hz	uint16	1	Generator
01037	8192	Generator Voltage L1-N	V	uint16	0	Generator
01038	8193	Generator Voltage L2-N	V	uint16	0	Generator
01039	8194	Generator Voltage L3-N	V	uint16	0	Generator
01043	8198	Load Current L1	A	uint16	0	Load
01044	8199	Load Current L2	A	uint16	0	Load
01045	8200	Load Current L3	A	uint16	0	Load
01053	8213	Battery Volts	V	int16	1	Controller I/O
01055	9153	Fuel Level	%	int16	0	Controller I/O
01263 - 01264	8205	Genset kWh	kWh	int32	0	Statistics
01298	9244	Engine State		String list		Info
01301	12944	Connection Type		String list		Info
01307 - 01322	24501	ID String		Long string		Info
01323 - 01330	24339	FW Version		Short string		Info
01382	9887	Controller Mode		string list		Info
03000 - 03007	8637	Gen-Set Name		Short string		Basic Settings / Name

22.5. Modbus holding registers for supported DSE genset controllers

The following table lists the Modbus holding registers the GX device reads. Note that this Modbus table reflects the DSE register list, not the GX device's. These definitions follow the Deep Sea Electronics GenComm standard (Version 2.236 MF). The Modbus register list for reading this data from the GX device can be found in the [download section](#) on the Victron website.

The registers marked *required* in the Remarks column are critical for identifying the DSE genset controllers in the GX device and for proper operation of the Victron ecosystem with the generator. Don't change them. All other registers are optional.

Note: *Page* and Register *offset* are terminology from the DSE GenComm standard.

Table 2. Holding registers

Register(s)	Page	Offset	Name	Units	Remarks
768	3	0	Manufacturer code		Required for DSE controller identification
769	3	1	Model number		
770	3	2	Serial number		
772	3	4	Control mode		
1024	4	0	Oil pressure	kPa	Required for the Victron ecosystem to work properly
1025	4	1	Coolant temperature	°C	
1026	4	2	Oil temperature	°C	
1027	4	3	Fuel level	%	
1029	4	5	Engine battery voltage	V	
1030	4	6	Engine speed	RPM	
1031	4	7	Generator frequency	Hz	
1032	4	8	Generator L1-N voltage	V	
1034	4	10	Generator L2-N voltage	V	
1036	4	12	Generator L3-N voltage	V	
1044	4	20	Generator L1 current	A	
1046	4	22	Generator L2 current	A	
1048	4	24	Generator L3 current	A	
1052	4	28	Generator L1 watts	W	
1054	4	30	Generator L2 watts	W	
1056	4	32	Generator L3 watts	W	
1536	6	0	Generator total watts	W	
1558	6	22	Generator % of full power	%	
1798	7	6	Engine run time	Seconds	
1800	7	8	Generator pos. kWh hours	kWh	
1808	7	16	Number of starts		
From 2048	8		Alarm conditions		
4096 to 4103	16		Control registers		
From 39424	154		Alarm conditions		